



**EL LIDER EN TECNOLOGÍA**  
THE LEADER IN TECHNOLOGY

**EL LIDER EN CALIDAD**  
THE LEADER IN QUALITY

**EL LIDER EN COMPROMISO  
MEDIOAMBIENTAL**  
THE LEADER IN THE COMMITMENT  
TO THE ENVIRONMENT

**EL LIDER EN SERVICIO**  
THE LEADER IN SERVICE







**A4-A20** **JMA, LA LLAVE DE LA EXCELENCIA**  
JMA, BIKAINTASUNAREN GILTZA  
JMA, THE KEY TO EXCELLENCE  
JMA, LA CLE DE L'EXCELLENCE  
JMA, DER SCHLÜSSEL ZUR EXZELLENZ

JMA Konpromisoa da  
JMA is Commitment  
JMA, l'engagement  
JMA bedeutet Verpflichtung

**A6-A7** **JMA, el Líder**  
JMA Liderra  
JMA the Leader  
JMA, le Leader  
JMA der Marktführer

**A8-A9** **JMA en el Mundo**  
JMA Munduan  
JMA Worldwide  
JMA dans le Monde  
JMA in der Welt

**A10-A13** **Tipos de Llaves**  
Giltza Motak  
Key Types  
Types de Clés  
Schlüsseltypen

**A14-A15** **Manual de uso**  
Erabilera-eskuliburua  
Manual of use  
Manuel d'utilisation  
Handbuch

**A16-A17** **Descripción y Terminología**  
Deskribapen eta Terminologia  
Description and Terminology  
Description et Terminologie  
Begriffserklärung und Terminologie

**A18-A19** **Símbolos y Nacionalidades**  
Ikur eta Nazionalitateak  
Symbols and Nationalities  
Symboles et Nationalités  
Symbole und Nationalitäten

**A21-A54** **ÍNDICES**  
AURKIBIDEAK  
CONTENTS  
TABLES DES MATIERES  
INHALT

**A21-A42** **Índice General**  
Aurkibide Orokorra  
General Index  
Index Generale  
Gesamtverzeichnis

**A43-A54** **Índice de Marcas**  
Marken Aurkibidea  
Brand Index  
Index Marque  
Hauptmarke

**01-350** **TIPOS DE LLAVES**  
GILTZA MOTAK  
TYPES OF KEYS  
TYPES DE CLÉS  
SCHLÜSSELTYPEN

**01-158** **Llaves Planas para Cerraduras de Cilindro**  
Sarraila Zilindrikotarako Giltza Zapalak  
Cylinder Keys  
Clés pour Cylindres  
Zylinderschlüssel

**159-241** **Llaves para Vehículos**  
Ibilgailuentzako Giltzak  
Keys for Vehicles  
Clés pour Véhicules  
Fahrzeugschlüssel

**242-244** **Llaves de Cierre**  
Ixteko Giltzak  
Snap-lock Keys  
Clés de Bouche d'eau  
Dornschlüssel

**245-255** **Llaves en Cruz**  
Gurutze-Giltzak  
Cruciform Keys  
Clés Cruciformes  
Kreuzschlüssel

**256-276** **Llaves de Gorja Acero Dulce**  
Altzairu Gozozko Gorja-Giltzak  
Mild Steel Bit Keys  
Clés à Gorges en Acier Doux  
Chubbschlüssel aus Weichstahl

**277-337** **Llaves de Gorja Latón**  
Letoizko Gorja Giltzak  
Brass Bit Keys  
Clés à Gorges en Laiton  
Chubbschlüssel aus Messing

**338-340** **Llaves de Gorja Zamak**  
Zamakezko Gorja Giltzak  
Zamak Bit Keys  
Clés à Gorges en Zamak  
Chubbschlüssel aus Zamak

**341-345** **Llaves Artísticas y de Armario Latón**  
Letoizko Giltzak: Armairuetarako eta Artistikoak  
Brass Furniture Keys  
Clés pour Meubles en Laiton  
Möbelschlüssel aus Messing

**346-347** **Llaves Artísticas y de Armario Zamak**  
Zamakezko Giltzak: Armairuetarako eta Artistikoak  
Zamak Furniture Keys  
Clés pour Meubles en Zamak  
Möbelschlüssel aus Zamak

**348-349** **Llaves para Casillas y Ascensores**  
Kutxatila eta Iggogailuentzako Giltzak  
Lift and Mail Box Keys  
Clés pour Ascenseurs et Boîtes à Lettres  
Briefkasten- und Liftschlüssel

**351-424** **GUIA DE MARCAS**  
MARKEN GIDA  
MAIN GUIDE  
GUIDE DES MARQUES  
MARKENINDEX

**351-390** **Automovil-Camioneta**  
Automobila-Kamioneta  
Car-Pick up  
Voiture-Camionnette  
Auto-Kleintransporter

**391-397** **Camión**  
Kamioia  
Trucks  
Camion  
Lkw

**399-418** **Motocicleta**  
Motozikleta  
Motorcycle  
Motocyclette  
Motorrad

**419-424** **Alarma - avión - bicicleta - caravana - tapón de gasolina - motor marino - portaesquí - tractor - escavadora - carretilla elevadora - corta césped**

Alarma - Hegazkina - Bizikleta - Karabana - Gasolina Tapoia - Itsas  
Motorra - Eskieuskaria - Traktorea - Hondeatzaila - Orga Jasotzaile -  
lea - Belarra Mozteko Makina

Alarm - Airplan - Bicycle - Caravans - Petrol Cap - Boat Engines  
- Ski Holder - Tractor - Earth Moving Machine - Forklift - Lawn  
Mower

Alarme - Avion - Bicyclette - Caravane - Bouchon Reservoir -  
Moteur de Bateau - Porte Ski - Traktor - Machine por Déplacement  
de Terre - Clark - Tondeuse

Alarm - Flugzeuge - Fahrräder - Wohnwagen - Tankverschlüsse  
- Schiffsmotoren - Skiträger Landmaschinen - Baummaschinen -  
Gabelstapler - Rasenmäher

ESPAÑOL

## NUESTRO ÉXITO ESTÁ BASADO EN EL COMPROMISO DE LAS PERSONAS

Alejandro Altuna S.A. es la sociedad matriz e impulsora de Altuna Group. Fabrica todo tipo de **llaves para cerradura** así como **máquinas duplicadoras**. Sus productos van destinados al mercado **OEM** y a la reposición, en este caso con la marca **JMA**.

Fundada por el Sr. Alejandro Altuna en 1942 arrancó su actividad en Mondragón. En poco tiempo, una nueva generación familiar que apostó por el desarrollo y la inversión impulsó a la empresa a un importante crecimiento que consolidó a la marca **JMA** hacia los 60 como líder indiscutible del país.

Posteriormente, la estrategia de apertura de mercados exteriores apoyada en la internacionalización y siempre basada en un enfoque innovador de los procesos industriales, ha convertido a **ALTUNA GROUP** en el **primer productor de llaves europeo y referente mundial** en este campo.

Actualmente, **15 compañías en 4 continentes** trabajan conjuntamente para el desarrollo y potenciación de la fuerza de nuestra marca JMA, conocida en más de 100 países en todo el mundo.

JMA integra equipos de **personas comprometidas** y motivadas por un proyecto común que nos ha permitido ser el mayor fabricante de llaves de Europa.

EUSKERA

## GURE ARRAKASTA PERTSONEN KONPROMISOAN DATZA

Alejandro Altuna S.A. Altuna Groupen sozietate matrizea eta sustatzaillea da. **Sarrailarako era guztietako giltzak** eta **kopiak egiteko makinak** ekoizten ditu. Bere produktuek **OEM** merkata eta birjarpena dute helburu, eta, kasu horretan, **JMA** markaz merkaturatzen dira.

Enpresa Alejandro Altuna jaunak sortu zuen 1942an, eta Arrasaten hasi zen lanean. Handik gutxira, familiako belaunaldi berriak garapenaren zein inbertsioaren alde egin zuen, eta enpresa bera ikaragarri hazi zen. Hori dela eta, 60ko hamarkadan, **JMA** marka herrialdeko lider eztabaidaezina zen.

Ondoren, kanpoko merkatuetara irekitzeko estrategia nazioarteko bihurtzeko prozesuan oinarritu da, eta, beti-beti, industria-prozesuen ikuspegi berritzailea hartu du kontuan. Horren ondorioz, **ALTUNA GROUP lehen giltzagilea da Europan**, baita arlo horretako **munduko erreferentea** ere.

Gaur egun, **15 konpainiak 4 kontinentetan** lan egiten dute elkarrekin, mundu zabaleko 100etik gora herrialdetan ezaguna den **JMA** markaren indarra garatzeko eta sustatzeko.

JMAko taldeetan **persona konprometitua** eta motibatua daude, eta proiektu bateratua dute. Horri esker, Europako enpresa giltzagile handiena da.

ENGLISH

## OUR SUCCESS IS BASED ON OUR PEOPLE'S COMMITMENT

Alejandro Altuna S.A. is the parent company and driving force behind the Altuna Group. It manufactures all types of **lock-keys and key-cutting machines**. Its products are for the **OEM** and replacement markets, in the latter case with the **JMA** brand.

Set up by Alejandro Altuna in 1942, it started the production in Mondragón (Spain). In a short time, a new generation of the family committed to development and investment saw the company through significant growth which consolidated the **JMA** brand in the 60's as the indisputable leader in Spain.

Later, the strategy of opening up to foreign markets backed by globalisation and always based on an innovative attitude towards industrial processes, turned the **ALTUNA GROUP** into the **largest producer of keys in Europe and a benchmark worldwide** in the field.

Currently **15 companies in four continents** work together to develop the strength of our **JMA** brand, well known in more than 100 countries all over the world.

This successful trail has lead us to become the biggest key producer in Europe based on **our people's commitment**.

# JMA ES COMPROMISO

## JMA IS COMMITMENT



### FRANÇAIS

#### NOTRE SUCCÈS EST FONDÉ SUR L'ENGAGEMENT DES PERSONNES

Alejandro Altuna S.A. est la société-mère qui a donné lieu au Groupe Altuna. Elle fabrique toutes sortes de **clés de serrure et de machines à copier**. Ses produits sont destinés au marché **OEM** et au remplacement, dans ce cas sous la marque **JMA**.

Alejandro Altuna en 1942, elle s'est établie à Mondragón. Très vite, une nouvelle génération familiale a misé sur le développement et grâce aux investissements engagés, l'entreprise a connu une forte croissance qui, dans les années 60, a imposé la marque **JMA** à la tête du secteur.

Par la suite, la stratégie d'ouverture sur les marchés extérieurs et une volonté d'internationalisation toujours sous-tendue par le recours aux procédés industriels les plus novateurs, a fait du **GROUPE ALTUNA** le **premier producteur de clés européen** et un **réfèrent mondial** dans ce domaine.

Actuellement, **15 firmes sur 4 continents** unissent leurs forces pour dynamiser et faire progresser notre marque JMA, connue dans plus de 100 pays du monde entier.

Les équipes JMA sont formées de **personnes motivées et pleinement investies** dans un projet commun qui nous a permis de devenir le plus important fabricant de clés d'Europe.

### DEUTSCH

#### UNSER ERFOLG BASIERT AUF DAS ENGAGEMENT VON MENSCHEN

Alejandro Altuna S.A. ist die Muttergesellschaft, aus der später die Altuna Group hervorging. Sie stellt **Schlüssel** aller Art sowie **Schlüsselkopiermaschinen** her. Ihre Produkte wenden sich an dem OEM- und den Ersatzschlüsselmarkt, in diesem Fall mit der Markenbezeichnung **JMA**.

Das Unternehmen wurde 1942 von Alejandro Altuna gegründet und begann seinen Werdegang in Mondragón. Innerhalb eines nur kurzen Zeitraums sorgte eine neue, auf Entwicklung und Investition setzende Familiengeneration für ein bedeutendes Wachstum und sicherte der Marke **JMA** damit Anfang der 60er Jahre die unbestreitbare Führungsposition im Land.

Später dann hat die auf das Konzept der Internationalisierung und der Innovation der industriellen Prozesse gestützte Strategie der Öffnung gegenüber ausländischen Märkten die **ALTUNA GROUP** zum **führenden europäischen Hersteller von Schlüsseln und einem weltweiten Bezugspunkt** für diesen Sektor werden lassen.

Derzeit arbeiten **15 Unternehmen in 4 Kontinenten gemeinsam**, um die Stärke der in über 100 Ländern der ganzen Welt bekannten Marke JMA zu potenzieren und weiterzuentwickeln.

JMA arbeitet mit Teams **engagierter und motivierter Menschen**, die sich für ein gemeinsames Projekt einsetzen, das es uns möglich gemacht hat, der größte Hersteller von Schlüsseln in Europa zu werden.

**THE KEY TO EXCELLENCE**  
GLOBALLY UNLOCKING MILLIONS OF DOORS DAILY

## ESPAÑOL:

### **LIDER EN TECNOLOGÍA:**

Una apuesta sólida por la calidad y la innovación basada en la automatización y garantía de procesos y soportada por una vocación inversora a largo plazo.

### **LIDER EN CALIDAD:**

En el ámbito de la Calidad Alejandro Altuna S.A. siempre ha sido una empresa líder y pionera en su sector. Nuestra política de calidad se basa en la prevención y planificación, mejora continua, satisfacción del cliente y participación de las personas

Estos valores están impregnados en nuestra empresa desde sus orígenes y han sido, junto con una adecuada política de inversión en instalaciones y maquinaria, el motivo principal de nuestro éxito, que además nos permite asegurar la competitividad de la empresa y con ello el futuro a largo plazo.

Además de la Certificación en Calidad de acuerdo a la ISO 9001, Alejandro Altuna S.A. acoge Sistemas de Gestión de la Calidad homologados por las empresas líderes del sector de automoción y residencial. Actualmente nuestra empresa es reconocida en el mercado como líder en este campo.

### **LIDER EN EL COMPROMISO POR EL MEDIO AMBIENTE:**

En Alejandro Altuna S.A. las buenas prácticas medioambientales son la norma y no la excepción. Nuestro equipo forma parte de un proyecto de empresa respetuoso con el medioambiente y que colabora con el desarrollo sostenible de nuestro entorno.

Alejandro Altuna S.A. fue el primer fabricante mundial de llaves en conseguir en 2000 el certificado ISO 14001 para su Sistema de Gestión. Este Sistema incorpora la política medioambiental, donde se recogen los valores y compromisos de la empresa, así como procedimientos que desarrollan los sistemas de trabajo y garantizan las correctas prácticas medioambientales en todos los ámbitos de la empresa.

### **LIDER EN SERVICIO:**

La realidad de una empresa se demuestra en su capacidad por responder con la máxima celeridad y eficacia a las necesidades y exigencias de los clientes. Se encuentran donde se encuentren. JMA pone a su disposición 5 plantas productivas en localizaciones estratégicas. Además, gracias a su amplia red de filiales y empresas distribuidoras repartidas por todo el mundo, le permite llegar a cualquier cliente, se cual sea su ubicación.



## EUSKERA:

### **LIDERRA TEKNOLOGIAN:**

Kalitatearen eta berrikuntzaren aldeko apustua sendoa da, prozesuen automatizazioan nahiz bermean oinarrituta eta epe luzerako inbertsioa eginda.

### **LIDERRA KALITATEAN:**

Kalitatearen arloan, Alejandro Altuna S.A. sektoreko enpresa liderra eta aitzindaria izan da beti. Hona hemen gure kalitate-politikaren oinarriak: prebentzioa, plangintza, etengabeko hobekuntza, bezeroaren poztasuna eta pertsonen partaidetza.

Balio horiek hasiera-hasieratik ezarri dira gure enpresan, eta, instalazio zein makinatan inbertitzeko politika egokiarekin batera, gure arrakastaren arrazoi nagusia izan dira. Horrez gain, enpresaren lehiakortasuna eta epe luzerako etorkizuna bermatzeko aukera ere eskaini digute.

ISO 9001en arabera kalitate-ziurtagiria ez ezik, Alejandro Altuna S.A. enpresak ibilgailu-industriako eta bizileku-sektoreko enpresa liderrek homologatutako kalitate-kudeaketarako sistemak ere baditugu. Gaur egun, merkatuaren arabera, gure enpresa liderra da arlo horretan.

### **LIDERRA INGURUMENAREKIKO KONPROMISOAN:**

Alejandro Altuna S.A. enpresan, ingurumen-arloko jarduera egokiak ez dira salbuespena, araua baizik. Gure taldea ingurumena errespetatu eta ingurunearen garapen iraunkorra sustatzen duen enpresa-proiektuaren barruan dago.

2000. urtean, Alejandro Altuna S.A. bere kudeaketa-sistemarako ISO 14001 ziurtagiria lortu zuen lehen giltzagilea izan zen munduan. Ingurumen-politika sistema horren barruan dago kokatuta, eta, bertan, enpresaren balioak zein konpromisoak azaltzen dira, baita lan-sistemak garatu eta enpresako arlo guztietan ingurumen-jarduera egokiak bermatzeko prozedurak ere.

### **LIDERRA ZERBITZUAN:**

Edonon daudela ere, bezeroen premiei eta eskakizunei ahalik eta azkarren eta era eraginkorrean erantzuteko daukan gaitasuna da enpresaren errealitatearen adierazgarri.

JMAk 5 ekoizpen-lantegi ditu leku estrategikoetan. Gainera, bere filialen sarea zabalarekin eta banaketa-enpresak mundu zabalean barreiatuta daudenez, edozein bezerorengana heldu daiteke, edonon dagoela ere.



# JMA, EL LIDER

## JMA, THE LEADER

### ENGLISH:

#### **THE LEADER IN TECHNOLOGY:**

Looking for the latest developments to improve the production processes together with a strong investment policy in all our plants to ensure the company's competitiveness and long-term future.

#### **THE LEADER IN QUALITY:**

As far as Quality is concerned, Alejandro Altuna S.A. has always been a leading, pioneering company in its sector. Our quality policy is based on prevention and planning, continuous improvement, customer satisfaction and people participation.

These values have been impregnated in our company from the start and have been, together with a good investment policy in terms of equipment and machinery, the main reason behind our success, which moreover enables us to ensure the company's competitiveness and long-term future.

In addition to Quality Certification to ISO 9001, Alejandro Altuna S.A. operates Quality Management Systems approved by the leading companies in the automotive and residential sectors. Our company is currently recognised in the market as a leader in this field.

#### **THE LEADER IN THE COMMITMENT TO THE ENVIRONMENT:**

At Alejandro Altuna S.A. best environmental practice is the norm and not the exception. Our team is part of a business project that respects the environment and contributes to the sustainable development of our community.

Alejandro Altuna S.A. was the first key manufacturer in the world to achieve ISO 14001 certification for its management system in 2000. This system incorporates the environmental policy, which includes the company's values and commitments, as well as procedures to set out the work systems and ensure good environmental practice throughout the company.

#### **THE LEADER IN SERVICE:**

The efficiency of a company is shown in its capacity to respond with the maximum speed and effectiveness to the needs and requirements of its customers, wherever they are based.

JMA places at your disposal 5 production plants based in strategic locations, Moreover, with its extensive network of associate and distribution companies located throughout the world, the company can reach any customer, wherever based.

### FRANÇAIS:

#### **LEADER EN TECHNOLOGIE:**

Un pari résolu sur la qualité et l'innovation basée sur l'automatisation et la garantie des process et soutenu par une vocation d'investissement à long terme.

#### **LEADER EN QUALITÉ:**

Dans le domaine de la Qualité, Alejandro Altuna S.A. a toujours été une entreprise pionnière et leader de son secteur. Notre politique de qualité est assise sur la prévention et planification, l'amélioration continue, la satisfaction du client et la participation des personnes. Ces valeurs irriguent notre entreprise depuis sa création. Soutenues par une politique constante d'investissement en installations et machines, elles expliquent, notre succès et, de plus, nous permettent d'assurer la compétitivité de l'entreprise et donc notre futur à long terme.

Bénéficiant de la Certification de Qualité selon la norme ISO 9001, Alejandro Altuna S.A. s'appuie sur des systèmes de gestion de la qualité homologués par les principaux constructeurs, aussi bien automobiles que du bâtiment. Aujourd'hui, notre entreprise est reconnue par le marché comme le leader du secteur.

#### **LEADER EN ENGAGEMENT ENVIRONNEMENTAL:**

Pour Alejandro Altuna S.A., les bonnes pratiques environnementales sont la règle et non l'exception. Notre équipe fait partie d'un projet entrepreneurial respectueux de l'environnement qui collabore au développement durable de notre milieu.

Alejandro Altuna S.A. a été le premier fabricant mondial de clés à obtenir, dès 2000, le certificat ISO 14001 pour son système de gestion. Ce système comporte deux piliers: la politique environnementale, où sont définis les valeurs et les engagements de l'entreprise, et les procédures qui développent les systèmes de travail et qui garantissent les bonnes pratiques environnementales dans tous les domaines d'activité.

#### **LEADER EN SERVICE:**

La réalité d'une entreprise se démontre par sa capacité à répondre le plus promptement et le plus efficacement possible aux besoins et aux exigences des clients. Où qu'ils se trouvent.

JMA place à leur disposition 5 sites de production situés dans des lieux stratégiquement choisis. De plus, grâce à notre vaste réseau de filiales et de distributeurs répartis dans le monde entier, nous pouvons toucher tous nos clients, où qu'ils soient.

### DEUTSCH:

#### **FÜHREND IN TECHNOLOGIE:**

Ein solider Einsatz für die Qualität und die Innovation, der sich auf Automatisierung und Prozesssicherheit sowie eine langfristige Investitionsgrundlage stützt.

#### **FÜHREND IN QUALITÄT:**

Auf dem Gebiet der Qualität war Alejandro Altuna S.A. stets ein führendes und bahnbrechendes Unternehmen des Sektors. Unsere Qualitätspolitik basiert auf Prävention und Planung, ständiger Verbesserung, Kundenzufriedenheit und Einbeziehung der Mitarbeiter.

Diese Werte sind schon seit den Anfängen fester Bestandteile unseres Unternehmens. Gemeinsam mit einer angemessenen Politik der Investition in Anlagen und Maschinenpark waren sie der wichtigste Grund für unseren Erfolg und sichern darüber hinaus die Wettbewerbsfähigkeit des Unternehmens und damit seine langfristige Zukunft.

Neben der Qualitätszertifizierung nach ISO 9001 verfügt Alejandro Altuna S.A. über Qualitätsmanagementsysteme, die von den führenden Automobil- und Wohnungsbauunternehmen zugelassen sind. Derzeit ist unser Unternehmen auf dem Markt für seine führende Position im Bereich Qualität bekannt.

#### **FÜHREND IM UMWELTSCHUTZ:**

Bei Alejandro Altuna S.A. sind gute Umweltpraktiken die Regel, nicht die Ausnahme. Unsere Mitarbeiter sind Teil des Projekts des umweltfreundlichen Unternehmens, das sich für die nachhaltige Entwicklung unserer Umwelt einsetzt. Alejandro Altuna S.A. erhielt im Jahr 2000 als weltweit erster Hersteller von Schlüsseln das Zertifikat ISO 14001 für sein Managementsystem. Dieses System umfasst die Umweltpolitik, die die Werte und Verpflichtungen des Unternehmens sowie die Verfahren für die Herstellungssysteme festlegt, und die korrekten Umweltpraktiken in allen Unternehmensbereichen garantiert.

#### **FÜHREND IM SERVICE:**

Die Realität eines Unternehmens zeigt sich in seiner Fähigkeit, in optimalem Zeitrahmen und mit maximaler Effizienz auf die Bedürfnisse und Anforderungen der Kunden zu reagieren, unabhängig davon, wo diese sich befinden. JMA verfügt über 5 Fertigungsstätten an strategischen Standorten. Dank eines über die ganze Welt ausgedehnten Netzes von Filialen und Vertriebshändlern ist das Unternehmen immer in der Nähe seiner Kunden, egal wo.

**15 COMPAÑÍAS EN 15 PAÍSES  
600 PERSONAS Y  
MÁS DE 550 MILLONES DE LLAVES AL AÑO  
EN MÁS DE 100 PAÍSES EN TODO EL MUNDO.**

**El potencial de JMA en el mundo está cimentado a través de sus plantas productivas y filiales comerciales en Europa, América del Norte y del Sur, Asia y África.  
La internacionalización es una estrategia prioritaria en JMA.**

**JMA MUNDUAN**

15 konpainia 15 herrialdean; 600 pertsona eta 550 milioitik gora giltza urtean, mundu zabaleko 100etik gora herrialdean.

JMA enpresak ahalmena du munduan, ekoizpen-lantegiak eta filial komertzialak dituelako Europan, Ipar Amerikan, Hego Amerikan, Asian eta Afrikan.  
Izan ere, nazioarteko bihurtzea lehentasunezko estrategia da JMArentzat.

**JMA WORLDWIDE**

15 companies in 15 countries; 600 people and over 550 million keys sold in more than 100 countries all over the 5 continents

JMA's potential worldwide is based on its production plants and commercial subsidiaries in Europe, North and South America, Asia and Africa.  
Globalisation is a priority strategy for JMA.

**JMA DANS LE MONDE**

15 sociétés dans 15 pays ; 600 personnes et plus de 550 millions de clés vendues chaque année dans plus de 100 pays de quatre continents

Le potentiel de JMA dans le monde est solidement ancré dans un réseau de production et de distribution qui couvre l'Europe, les deux Amériques, l'Asie et l'Afrique.  
L'internationalisation est une stratégie prioritaire pour JMA.

**JMA IN DER WELT**

15 Unternehmen in 15 Ländern; 600 Personen und über 550 Millionen Schlüssel pro Jahr in über 100 Ländern der ganzen Welt.

Das Leistungspotenzial von JMA in der ganzen Welt wird durch seine Produktionsstätten und Handelsfilialen in Europa, Nord- und Südamerika, Asien und Afrika konsolidiert. Internationalisierung ist eine vorrangige Strategie von JMA.



● **PLANTAS PRODUCTIVAS**  
MANUFACTURING PLANTS

● **CENTROS DE DISTRIBUCIÓN**  
DISTRIBUTION CENTERS

# JMA EN EL MUNDO

JMA WORLDWIDE

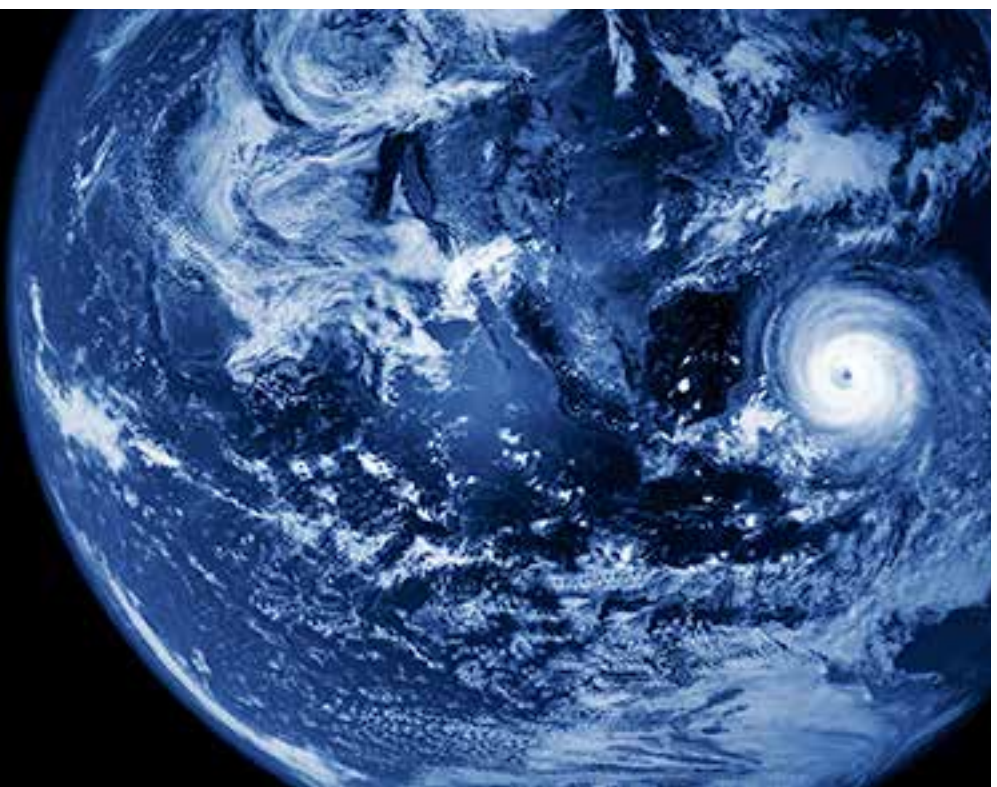

**THE KEY TO EXCELLENCE**  
GLOBALLY UNLOCKING MILLIONS OF DOORS DAILY



**01-158**

**LLAVES PLANAS PARA CERRADURAS DE CILINDRO**

SARRAILA ZILINDRIKOTA-  
RAKO GILTZA ZAPALAK

CYLINDER KEYS

CLÉS POUR CYLINDRES

ZYLINDERSCHLÜSSEL



**159-241**

**LLAVES PARA VEHÍCULOS**

IBILGAILUENTZAKO  
GILTZAK

KEYS FOR VEHICLES

CLÉS POUR VÉHICULES

FAHRZEUGSCHLÜSSEL



**242-244**

**LLAVES DE CIERRE**

IXTEKO GILTZAK

SNAP-LOCK KEYS

CLÉS DE BOUCHE D'EAU

DORNSCHLÜSSEL



**245-255**

**LLAVES EN CRUZ**

GURUTZE-GILTZAK

CRUCIFORM KEYS

CLÉS CRUCIFORMES

KREUZSCHLÜSSEL



**256-276**

**LLAVES DE GORJA ACERO DULCE**

ALTZAIRU GOZOZKO  
GORJA-GILTZAK

MILD STEEL BIT KEYS

CLÉS À GORGES EN ACIER DOUX

CHUBBSCHLÜSSEL  
AUS WEICHSTAHL





# TIPOS DE LLAVES

## KEY TYPES

**277-337**

### LLAVES DE GORJA LATÓN

LETOIZKO GORJA GILTZAK

BRASS BIT KEYS

CLÉS À GORGES EN  
LAITON

CHUBBSCHLÜSSEL AUS  
MESSING

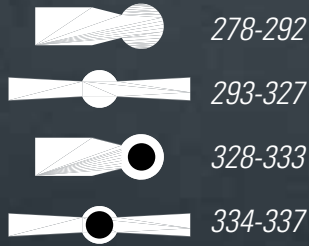

**338-340**

### LLAVES DE GORJA ZAMAK

ZAMAKEZKO GORJA  
GILTZAK

ZAMAK BIT KEYS

CLÉS À GORGES EN ZAMAK

CHUBBSCHLÜSSEL AUS  
ZAMAK



**341-345**

### LLAVES ARTÍSTICAS Y DE ARMARIO LATÓN

LETOIZKO GILTZAK:  
ARMAIRUETARAKO  
ETA ARTISTIKOAK

BRASS FURNITURE KEYS

CLÉS POUR MEUBLES EN LAITON

MÖBELSCHLÜSSEL  
AUS MESSING



**346-347**

### LLAVES ARTÍSTICAS Y DE ARMARIO ZAMAK

ZAMAKEZKO GILTZAK:  
ARMAIRUETARAKO  
ETA ARTISTIKOAK

ZAMAK FURNITURE KEYS

CLÉS POUR MEUBLES EN ZAMAK

MÖBELSCHLÜSSEL AUS ZAMAK



**348-349**

### LLAVES PARA CASILLAS Y ASCENSORES

KUTXATILA ETA  
IGOGAILUENTZAKO GILTZAK

LIFT AND MAIL BOX KEYS

CLÉS POUR ASCENSEURS ET  
BOITES A LETTRES

BRIEFKASTEN- UND  
LIFTSSCHLÜSSEL



**THE KEY TO EXCELLENCE**  
GLOBALLY UNLOCKING MILLIONS OF DOORS DAILY

## GRABADAS

GILTZA GRABATUAK  
COINED KEYS  
CLÉS FRAPÉES  
PRÄGESCHLÜSSEL

*Consultar Referencias  
Erreferentziak Kontsultatu  
Check References  
Voir Références  
Referenzen Konsultieren*



## ALUMINIO

*Consultar Referencias  
Erreferentziak Kontsultatu  
Check References  
Voir Références  
Referenzen prüfen*



## WIND-COLOR

*Consultar Referencias  
Erreferentziak Kontsultatu  
Check References  
Voir Références  
Referenzen prüfen*



## COLORMATIC

*Consultar Referencias  
Erreferentziak Kontsultatu  
Check References  
Voir Références  
Referenzen prüfen*



# LLAVES ESPECIALES

SPECIAL KEYS

## FASHION

*Consultar Referencias  
Erreferentziak Kontsultatu  
Check References  
Voir Références  
Referenzen prüfen*



## PET COLLECTION

*Consultar Referencias  
Erreferentziak Kontsultatu  
Check References  
Voir Références  
Referenzen prüfen*



## STYLCOLOR

*Consultar Referencias  
Erreferentziak Kontsultatu  
Check References  
Voir Références  
Referenzen prüfen*





## ESPAÑOL

### AVISO LEGAL - CATÁLOGO GENERAL C.11

Las llaves que aparecen en este catálogo son piezas JMA fabricadas por Alejandro ALTUNA S.A. o un subcontratista de éste. Están diseñadas para cilindros y cerraduras de los fabricantes cuyas marcas se indican en este catálogo.

Conforme a las disposiciones legales vigentes relativas a la propiedad industrial, las marcas o nombres comerciales indicados en este catálogo son propiedad exclusiva de los fabricantes de cilindros y cerraduras, así como de los fabricantes de automóviles, otros constructores, distribuidores y usuarios.

Dichas marcas o nombres comerciales se indican en calidad simplemente informativa con el fin de reco-

nocer con rapidez la cerradura a la que corresponden nuestras piezas.

Este catálogo está reservado exclusivamente a profesionales de la reproducción de llaves que utilizan piezas JMA.

Los datos referentes a los productos de este catálogo tienen carácter indicativo. Manteniendo siempre las características básicas, nos reservamos el derecho de realizar, sin previo aviso, modificaciones técnicas, estéticas o de otro tipo, por razones de evolución de los productos en cuestión.

Algunos modelos que están en este nuevo catálogo podrán recibirlos tanto con la marca y la referencia JMA como con otra marca del grupo ALTUNA.

## EUSKERA

### LEGE-OHARRA - KATALOGO OROKORRA C.11

Katalogo honetan ageri diren giltzak Alejandro ALTUNA SA enpresak edo honek kontratatutako beste enpresa batek egindako JMA piezak dira. Katalogoan zehazten diren marken fabrikatzaileen zilindro eta sarrailetarako diseinatuta daude.

Jabetza industrialari buruz indarrean dauden lege-xedape-nekin bat etorri, katalogo honetan zehaztutako merkataritza-markak edo izenak zilindro eta sarraileen fabrikatzaileen nahiz ibilgailuen fabrikatzaileen eta beste erakitzailen, banatzaileen eta erabiltzaileen batzuen jabetza eskusibokoak dira.

Merkataritza-marka edo izen horiek zehaztasun gehiago emateko adierazten dira, gure piezak zein sarraileari dagozkion berehala ikusi ahal izateko.

Katalogo hau giltzen kopiari egiteko JMA piezak erabiltzen dituzten profesionalentzako da soilik.

Katalogo honetako produktuei buruzko datuek izaera adierazgarria dute. Oinarriko ezaugarriak gordez, produktuen bilakaeraren ondoriozko aldaketak teknikoak, estetikoak edo bestelakoak egiteko eskubidea dugu, aurretik horren berri eman beharrik gabe.

Katalogo berri honetan dauden eredu eta batzuk JMA marka eta erreferentziarekin nahiz ALTUNA taldeko beste marka batekin jaso ahal izango dira.

## ENGLISH

### LEGAL WARNING - GENERAL CATALOGUE C.11

The keys that appear in this catalogue are JMA parts manufactured by Alejandro ALTUNA S.A. or one of its subcontractors. They are designed for cylinders and locks made by the manufacturers whose trademarks are indicated in this catalogue.

In accordance with legal requirements relating to industrial property rights, the trademarks or trade names indicated in this catalogue are the exclusive property of the manufacturers of the cylinders and locks, as well as automobile manufacturers, other constructors, distributors and users.

The aforementioned trademarks or trade names are indicated simply for information purposes so that the lock to which our parts correspond can be recognised quickly and easily. This catalogue is for the exclusive use of professional key copiers who use JMA parts.

Data referring to the products in this catalogue are indicative in nature. Although the basic characteristics are maintained at all times, we reserve the right to make, without previous notice, any technical, aesthetic or other types of changes involved in the development of the products in question. Some of the keys in this new catalogue could be received either with the JMA reference and trademark or with another trademark from the ALTUNA group.

## FRANÇAIS

### MENTIONS LEGALES - CATALOGUE GENERALE C.11

Les ébauches de clés reportées sur ce catalogue sont des ébauches JMA fabriquées par Alejandro ALTUNA S.A. ou un de ses sous-traitants Elles sont destinées aux cylindres et serrures des fabricants dont les marques sont indiquées dans ce catalogue.

Conformément aux dispositions légales en vigueur relatives à la propriété industrielle, les marques ou les dénominations commerciales citées dans ce catalogue sont la propriété exclusive des fabricants de cylindres et de serrures ainsi que des constructeurs de voitures, autres constructeurs, distributeurs et utilisateurs.

Ces marques ou dénominations commerciales sont indiquées à titre de simple information afin de connaître rapidement à quelle serrure nos ébauches sont destinées.

Ce catalogue est exclusivement réservé aux professionnels de la reproduction de clés, utilisant des ébauches JMA.

Les renseignements sur les produits de ce catalogue sont donnés à titre indicatif. Tout en gardant les caractéristiques de base, nous nous réservons le droit d'apporter, sans préavis, des modifications techniques, esthétiques ou autres, dues à l'évolution des produits en question.

Des ébauches de ce catalogue pourront être livrées soit avec la marque et référence JMA soit avec une autre marque du groupe ALTUNA.

## DEUTSCH

### IMPRESSUM- GESAMTKATALOG C.11

Die in dem vorliegenden Katalog aufgeführten Schlüssel sind JMA-Teile, die von der Firma Alejandro ALTUNA, S.A., einem Zulieferanten von JMA, hergestellt werden. Sie sind für Zylinder und Schlösser derjenigen Hersteller entwickelt worden, deren Marken in diesem Katalog aufgeführt sind.

In Übereinstimmung mit den geltenden gesetzlichen Vorschriften bezüglich des gewerblichen Eigentums sind die im vorliegenden Katalog aufgeführten Marken und Firmennamen ausschließliches Eigentum der Zylinder- und Schloßhersteller, sowie der Automobilhersteller und anderer Konstrukteure, Vertrieber und Benutzer.

Diese Marken und Firmennamen werden nur zu Informationszwecken aufgeführt, mit dem Ziel, auf schnelle Weise zu erkennen, zu welchem Schloß unsere Teile gehören.

Dieser Katalog ist ausschließlich für Fachleute des Bereichs der Schlüsselreproduktion gedacht, die JMA-Teile verwenden.

Die Daten bezüglich der Produkte des vorliegenden Katalogs haben informativen Charakter. Bei Aufrechterhaltung der grundlegenden Eigenschaften behalten wir uns das Recht vor, aus Gründen der Entwicklung der entsprechenden Produkte und ohne Vorankündigung technische, ästhetische oder andere Änderungen vorzunehmen. Einige Modelle des neuen Katalogs können Sie sowohl mit der Marke und der Bezeichnung JMA erhalten, als auch mit jeder anderen Marke der Gruppe ALTUNA.

**THE KEY TO EXCELLENCE**  
GLOBALLY UNLOCKING MILLIONS OF DOORS DAILY





# MANUAL DE USO

## MANUAL OF USE

### ESPAÑOL

#### MANUAL DE USO

Todas las llaves del catálogo están en escala 1:1; tanto la silueta como el perfil, para hacer una búsqueda más fácil y precisa. Pasos a seguir para la identificación de la llave:

**1. Identificación de la silueta:** Confirmar que la llave que busca coincide con las dimensiones de la llave catálogo. Ver Fig. 1

#### 2. Identificación del perfil:

**2.1** Ver si el perfil de la llave y el perfil del catálogo forman una misma imagen. Ver Fig. 2.1

**2.2** Cerciorar que el perfil del catálogo tiene la misma forma y dimensión, colocando la llave física sobre la imagen del catálogo. Ver Fig. 2.2

### EUSKERA

#### ERABILERA-ESKULIBURUA:

Katalogoko giltza guztiak 1:1 eskalan agertzen dira; hala silueta nola profila, bilaketa errazagoa eta zehatzagoa izan dadin. Giltza identifikatzeko urratsak:

**1. Silueta identifikatzea:** Bilatzen den giltzak katalogoan agertzen den giltzaren dimentsio bera duela baiezatu. Ikus 1. irudia.

#### 2. Profila identifikatzea:

**2.1** Giltzaren profilak eta katalogoko profilak irudi bera osatzen duten ikusi. Ikus 2.1. irudia.

**2.2** Katalogoko profilak forma eta dimentsio bera duela ziurtatzea, giltza fisikoa katalogoko irudiaren gainean jarri. Ikus 2.2. irudia.

### ENGLISH

#### MANUAL OF USE

All the keys in this catalogue are 1:1 scale; both the silhouette outline and profile, to facilitate a precise search. Steps to follow for identifying the key:

**1. Identification of the silhouette:** Confirm that the key you want matches with the dimensions of the key in the catalogue. See Fig. 1

#### 2. Identification of the profile:

**2.1** Check to see if the profile of the original key and the profile in the catalogue have a similar shape. See Fig. 2

**2.2** Make sure the profile of the catalogue has the same shape and dimension, by placing the physical key over the image in the catalogue. See Fig. 2.2

### FRANÇAIS

#### MANUEL D'UTILISATION

Toutes les clés du catalogue sont à l'échelle 1:1; aussi bien la silhouette que le profil, afin de permettre une recherche plus simple et précise. Étapes à suivre pour l'identification de la clé :

**1. Identification de la silhouette :** Confirmer que la clé recherchée correspond aux dimensions de la clé du catalogue. Voir Fig.1

#### 2. Identification du profil :

**2.1.** Voir si le profil de la clé correspond au profil du catalogue. Voir Fig.2.1

**2.2.** S'assurer que le profil du catalogue a la même forme et les mêmes dimensions, en plaçant la clé physique sur l'image du catalogue. Voir Fig.2.2

### DEUTSCH

#### HANDBUCH

Alle Schlüssel im Katalog sind im Maßstab 1:1 dargestellt, sowohl als Silhouette als auch im Profil, um die Suche leichter und genauer zu machen. Zu befolgende Schritte für die Identifizierung des Schlüssels:

**1. Identifizierung der Silhouette:** Bestätigung, dass der gesuchte Schlüssel mit dem Abmessungen im Katalog übereinstimmt. Siehe Abb. 1

#### 2. Identifizierung des Profils:

**2.1.** Prüfen, ob das Profil des Schlüssels und das im Katalog gezeigte Profil übereinstimmen. Siehe Abb. 2.1

**2.2.** Vergewissern, dass das Profil im Katalog die gleiche Form und Größe hat, indem man den tatsächlichen Schlüssel auf das Katalogbild legt. Siehe Abb. 2.2

## IDENTIFICACIÓN DE LA LLAVE

### IDENTIFICACIÓN DE LA LLAVE

#### 1. Identificación de la Silueta

##### Identificación de la Silueta

# 1



#### 2. Identificación del perfil

##### Identificación del perfil

# 2.1



# 2.2

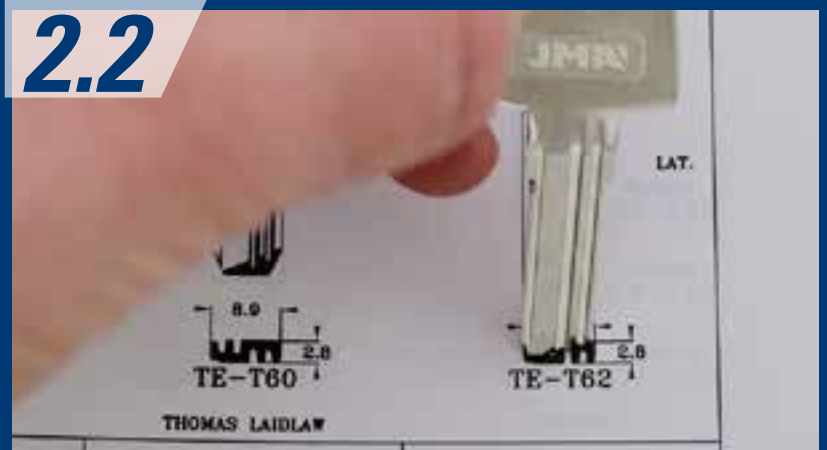

**ESPAÑOL**

- 1 MARCA PRINCIPAL
- 2 CABEZA
- 3 CUELLO
- 4 TOPE
- 5 PALETÓN
- 6 PUNTA
- 7 UTILIZACIÓN
- 8 NOMENCLATURA DE PERFIL ORIGINAL
- 9 PERFIL IZQUIERDO
- 10 PERFIL DERECHO
- 11 REFERENCIA
- 12 MARCAS SECUNDARIAS
- 13 SERIES
- 14 MARCA PRINCIPAL
- 15 MARCAS SECUNDARIAS DE LA PRINCIPAL (ABSA)

**1 ABSA**

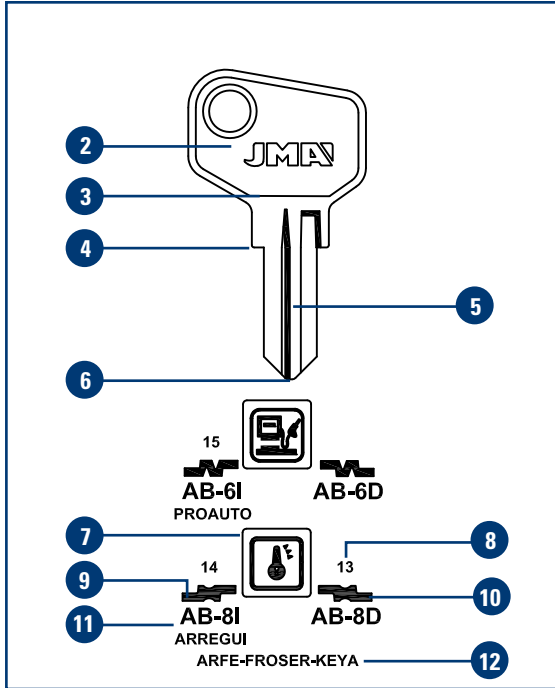

**1 VACHETTE**

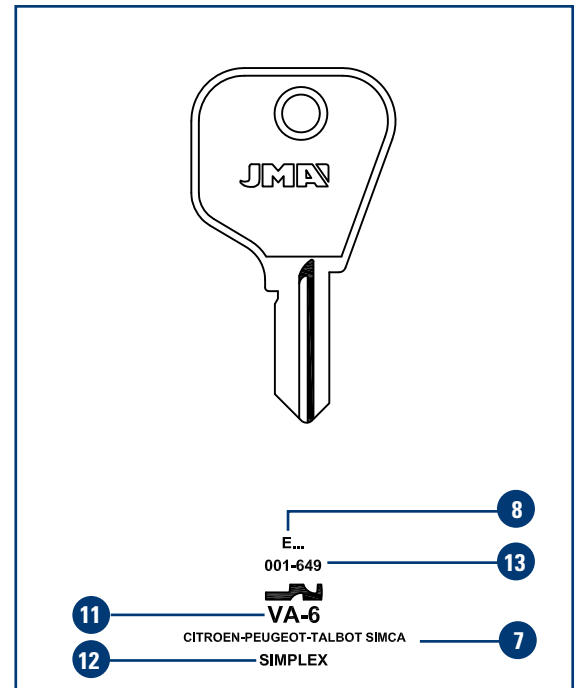

EUSKERA	ENGLISH	FRANÇAIS	DEUTSCH
1 MARKA NAGUSIA	1 MAIN BRAND	1 MARQUE PRINCIPALE	1 HAUPTPRÄGUNG
2 BURUA	2 HEAD	2 TÊTE	2 KOPF
3 LEPOA	3 NECK	3 COU	3 HALS
4 TOPEA	4 SHOULDER	4 ARRÊT	4 ANSCHLAG
5 BELARRIA	5 BLADE	5 CANON	5 SCHAFT
6 PUNTA	6 TIP	6 POINTE	6 SPITZE
7 ERABILERA	7 USE	7 UTILISATION	7 VERWENDUNG
8 JATORRIZKO PROFILAREN IZENDEGIA	8 ORIGINAL PROFILE	8 PROFIL ORIGINAL	8 ORIGINALPROFIL
9 EZKERREKO PROFILA	9 LEFT PROFILE	9 PROFIL GAUCHE	9 LINKSPROFIL
10 ESKUINEKO PROFILA	10 RIGHT PROFILE	10 PROFIL DROIT	10 RECHTSPROFIL
11 ERREFERENTZIA	11 REFERENCE	11 RÉFÉRENCE	11 BEZEICHNUNG
12 BIGARREN MAILAKO MARKAK	12 SECONDARY BRAND	12 MARQUE SECONDAIRE	12 2. PRÄGUNG
13 SERIEAK	13 SERIES	13 CODE	13 SERIE
14 MARCA NAGUSIA ETA JATORRIZKOA	14 MAIN BRAND AND NATIONALITY	14 MARQUE PRINCIPALE ET NATIONALITÉ	14 HAUPTPRÄGUNG UND NATIONALITÄT
15 MARKA NAGUSIAREN BIGARREN MAILAKO MARKAK (ABSA)	15 SECONDARY BRANDS OF THE MAIN ONE (ABSA)	15 MARQUES SECONDAIRES DE LA PRINCIPALE (ABSA)	15 2. PRÄGUNG FÜR HAUPTPRÄGUNG (ABSA)

# DESCRIPCIÓN Y TERMINOLOGÍA

## KEY DESCRIPTION AND TERMINOLOGY

### ESPAÑOL

- 1 CABEZA
- 2 CUELLO
- 3 DIÁMETRO DE LA CAÑA
- 4 CAÑA
- 5 LONGITUD A
- 6 PALETON
- 7 PERFIL MACHO
- 8 REFERENCIA
- 9 MARCA ORIGINAL
- 10 PERFIL HEMBRA

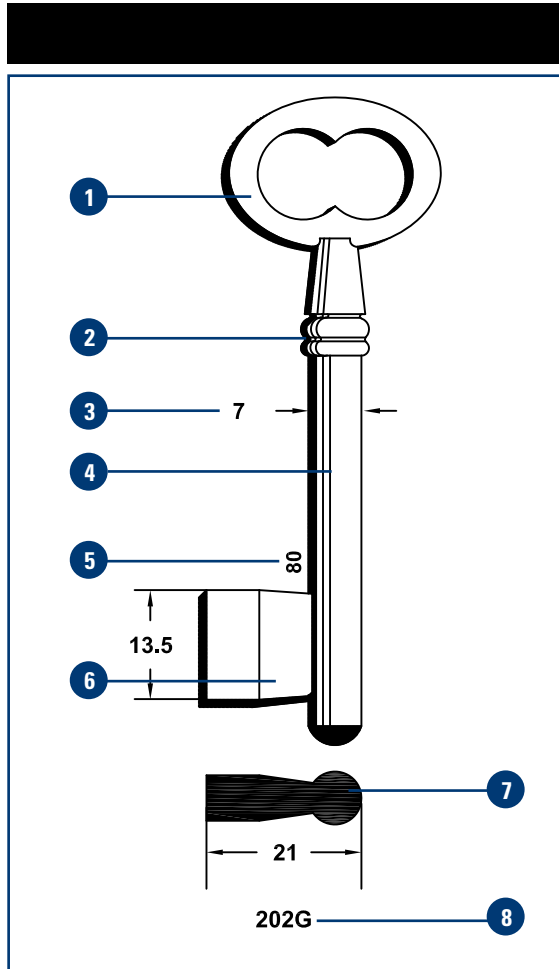

### 9 — ORENGO

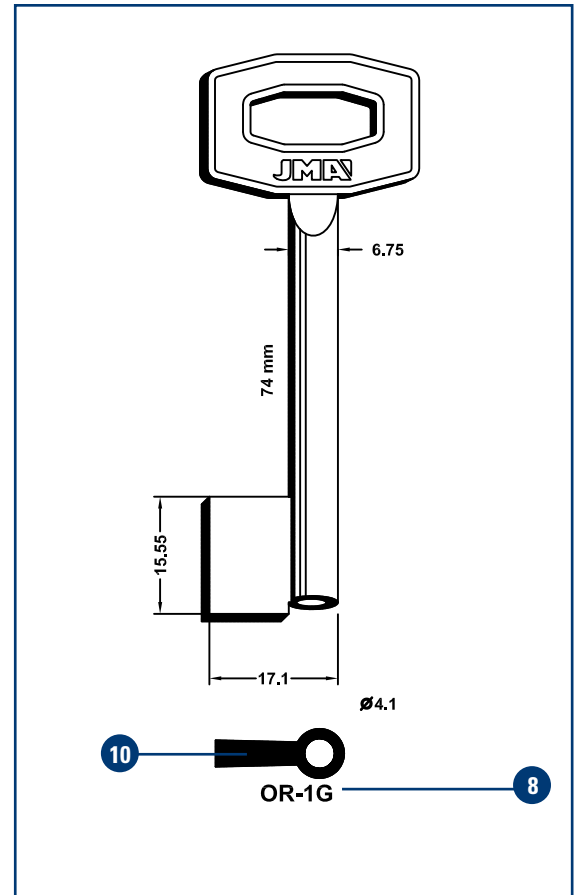

EUSKERA	ENGLISH	FRANÇAIS	DEUTSCH
1 BURUA	1 HEAD	1 TÊTE	1 KOPF
2 LEPOA	2 NECK	2 COU	2 HALS
3 ZIRIAREN DIAMETROA	3 SHANK DIAMETER	3 DIAMETRE DU CANON	3 HALM- DURCHMESSER
4 ZIRIA	4 SHANK	4 CANON	4 HALM
5 A LUZERA	5 LENGTH A	5 LONGUEUR A	5 LÄNGE A
6 BELARRIA	6 BIT	6 PANNETON	6 BART
7 PROFIL ARRA	7 PIN BIT PROFILE	7 PROFIL MALE	7 SCHWEIFUNG
8 ERREFERENTZIA	8 REFERENCE	8 RÉFÉRENCE	8 BEZEICHNUNG
9 JATORRIZKO MARKA	9 ORIGINAL BRAND	9 MARQUE ORIGINALE	9 ORIGINAL- PRÄGUNG
10 PROFIL EMEA	10 PIPE BIT PROFILE	10 PROFIL FEMELLE	10 GEBOHRT

**ALP.**

**Llave fabricada en alpaca**

Alpakaz egindako giltza  
Key available in nickel silver  
Clé fabriquée en maillechort  
Schlüssel auch in Neusilber lieferbar

**LAT.**

**Llave disponible también en latón**

Giltza, letoizkoa ere eskuragarria  
Key also available in brass  
Clé aussi disponible en laiton  
Schlüssel auch in Messing lieferbar

**COL.**

**Llave disponible también con cabeza de plástico en colores**

Giltza hau koloretako plastikozko buruarekin ere eskuragarria

Key also available with coloured plastic head

Clé aussi disponible avec tête plastifiée en couleurs

Schlüssel auch mit farbigem Plastikkopf lieferbar

**ALU.**

**Llave disponible también en aluminio**

Giltza, aluminioan ere eskuragarria  
Key also available in aluminium  
Clé aussi disponible en aluminium  
Schlüssel auch in Aluminium lieferbar

**ZAM.**

**Llave fabricada solamente en zamak**

Zamakez soilik egindako giltza  
Key only available in zamak  
Clé aussi disponible en zamak  
Schlüssel nur aus Zamak lieferbar



35

**Llave de utilizacion en candados**

Giltzarrapoetan erabiltzeko giltzak  
Key for padlocks  
Clé pour cadenas  
Schlüssel für Hangschlösser



**Llave de utilización en cerraduras auxiliar**

Sarraila osagarrietan erabiltzeko giltzak  
Key for cam locks  
Clé pour petite serrurie  
Schlüssel für Hebelschlösser



**Llaves para motocicletas**

Motozikleta giltzak  
Key for motorcycles  
Clé pour motocyclettes  
Schlüssel für Motorräder



**Llave para tapón de gasolina**

Gasolina-tapoietarako giltza  
Key for fuel cap  
Clé pour bouchon d'essence  
Schlüssel für Tankdeckel



**Llave para camión**

Kamioiko giltza  
Key for lorries  
Clé pour camion  
Schlüssel für Lastkraftwagen



**Alarma**

Alarma  
Alarm  
Alarme  
Alarm



**Llaves gorja con acabado en color natural**

Gorja giltzak berezko kolorezko akaberarekin  
Bit key blank with natural colour finishing  
Clé à gorges avec finition en couleur naturel  
Chubbsschlüssel in naturfarben Ausführung



**Llaves gorja con acabado en negro antiguo**

Gorja giltza, beltz zaharkitu akaberarekin  
Bit key blank with old black finishing  
Clé à gorges avec finition en vieux noir  
Chubbsschlüssel in altschwarzer Ausführung

**NACIONALIDAD** - NAZIONALITATEA - NATIONALITY - NACIONALITÉ - NATIONALITÄT

AUSTRIA  
AUSTRALIA  
BELGIUM  
BRAZIL  
CANADA  
SWITZERLAND  
GERMANY  
DENMARK

**A**  
**AUS**  
**B**  
**BR**  
**CDN**  
**CH**  
**D**  
**DK**

ALGERIA  
SPAIN  
ESLOVAKIA  
EGYPT  
FRANCE  
GREAT BRITAIN  
GREECE  
HUNGARY

**DZ**  
**E**  
**ES**  
**ET**  
**F**  
**GB**  
**GR**  
**H**

HONG KONG  
CROATIA  
ITALY  
ISRAEL  
INDIA  
EIRE  
JAPAN  
KOREA

**HK**  
**HR**  
**I**  
**IL**  
**IND**  
**IRL**  
**J**  
**K**



# SÍMBOLOS

## SYMBOLS

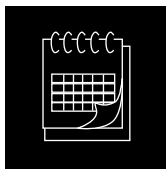

### Calendario

Egutegia  
Calendar  
Calendrier  
Kalender

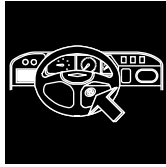

### Contacto auto

Autoko kontaktua  
Engine ignition  
Contact auto  
Zündschloss Pkw

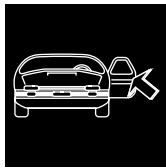

### Puerta

Atea  
Door lock  
Portière  
Türe

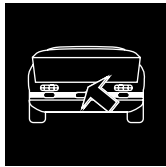

### Maletero/Puerta trasera

Maletategia/Atzeko atea  
Boot/Hatchback  
Coffre/Portière postérieure  
Kofferraum/Hecktür



### Tapón de gasolina

Gasolina-tapoia  
Petrol cap  
Bouchon réservoir  
Benzintankverschluss

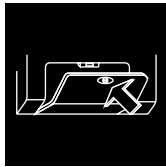

### Guantera

Eskularru-kutxa  
Drawer  
Tiroir  
Schublade

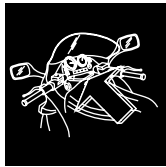

### Contacto moto

Moto-kontaktua  
Motorbike ignition  
Contact moto  
Zündschloss Motorrad

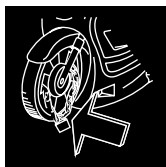

### Bloqueo moto

Moto-blokeoa  
Motorbike disc lock  
Bloquage moto  
Bremsenschloss Motorrad

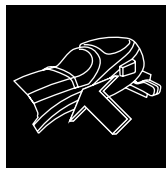

### Sillin

Zela  
Cycle seat  
Selle  
Sattel

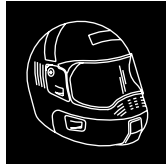

### Casco

Kaskoa  
Helmet  
Casque  
Helm

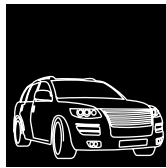

### Automovil / camioneta

Automobila / kamioneta  
Car / Pick-up trucks  
Voiture / Camionnette  
Auto / Kleintransporter

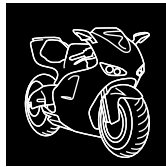

### Motocicleta

Motozikleta  
Motorcycle  
Motocyclette  
Motorrad



### Camión

Kamioia  
Trucks  
Camion  
Lkw

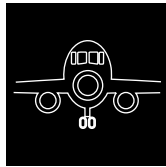

### Avión

Hegazkina  
Aeroplane  
Avion  
Flugzeuge

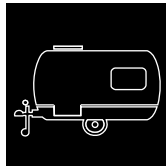

### Caravana

Karabana  
Caravans  
Caravane  
Wohnwagen

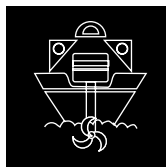

### Motor marino

Itsas motorra  
Boat engines  
Moteur de bateau  
Schiffsmotoren

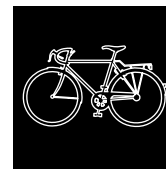

### Bicicleta

Bizikleta  
Bicycle  
Bicyclette  
Fahrräder

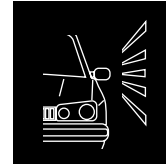

### Alarma

Alarma  
Alarm  
Alarme  
Alarm

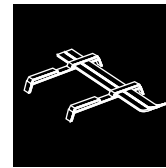

### Portaesquis

Eski-euskarria  
Ski holder  
Porte ski  
Skiträger

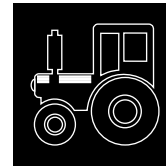

### Tractor

Traktorea  
Tractor  
Traktor  
Landmaschinen

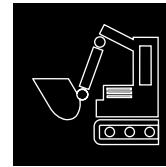

### Escavadora

Hondeatzailea  
Earth moving machine  
Machine déplacement de terre  
Baumaschinen



### Carretilla elevadora

Orga jasotzailea  
Forklift  
Clark  
Gabelstapler



### Corta cesped

Belarra mozteko makina  
Lawn-mower  
Tondeuse  
Rasenmäher



### Alarma - llave

Alarma - giltza  
Alarm - key  
Alarme - clef  
Alarm - Schlüssel

KUWAIT  
MEXICO  
NORWAY  
THE NETHERLANDS  
PORTUGAL  
PERU  
POLAND  
ARGENTINA

**KW**  
**MEX**  
**N**  
**NL**  
**P**  
**PE**  
**PL**  
**RA**

TAIWAN  
CHILE  
CHEKIA  
RUMANIA  
SWEDEN  
FINLAND  
SLOVENIA  
RUSIA

**RC**  
**RCH**  
**RCZ**  
**RU**  
**S**  
**SF**  
**SLO**  
**RJ**

CHINA  
TUNISIA  
UNITED STATES OF AMERICA  
YUGOSLAVIA  
VENEZUELA  
ZAMBIA

**TJ**  
**TN**  
**USA**  
**YU**  
**YV**  
**Z**



# ÍNDICE DE GENERAL

AURKIBIDEA OROKORRA

GENERAL INDEX

INDEX GENERALE

GESAMTVERZEICHNIS



**THE KEY TO EXCELLENCE**  
GLOBALLY UNLOCKING MILLIONS OF DOORS DAILY

REF.	PAG.
1G	278
2G	278
3G	278
3M-1D	1
4G	278
5G	278
5-L	135
6-C	146
6G	278
6-L	146
7G	278
7-S	118-349
8G	278
8M-1D	105
11G	279
12G	279
13G	279
14G	279
15-D	223
15G	279
15-I	223
16-D	224
16G	279
16-I	224
17G	279
19G	280
21G	280
23G	280
24G	280
25G	280
26-M	112-349
28-D	162
35-D	146
35-I	146
38-D	146
38-I	146
41-4-4	209
45-1	1
45-1D	1
45-2	1
45-2D	1
48-D	185
48-I	185
51G	328
52G	328
52GPC	328
53G	328
54G	328
55G	328
56G	328
57G	328
66G	329
68G	329
72G	329
73G	329
74G	267
101G	337
126H-60G	283
126N-60G	283

REF.	PAG.
126PP-60G	283
200G	257
201G	257
202G	257
203G	257
204G	257
205G	257
206G	257
207G	258
208G	258
209G	258
210G	258
211G	258
212G	259
213G	259
214G	259
215G	259
216G	259
217G	259
218G	260
219G	260
220G	260
221G	260
222G	260
223G	260
224G	260
225G	260
226G	261
227G	261
228G	261
229G	261
230G	261
231G	261
232G	261
233G	261
234G	262
235G	262
236G	262
237G	262
238G	262
239G	262
303-1	1
303-1D	1
333-1D	1
333-2D	1
500	243
501	243
502	243
503	243
504	243
505	243
506	243
507	243
508	243
509	243
510	243
511	244
512	244
513	244
600G	263

REF.	PAG.
601G	263
602G	263
603G	263
604G	263
605G	263
606G	263
607G	263
608G	264
609G	264
610G	264
611G	264
612G	264
613G	264
614G	265
615G	265
616G	265
618G	265
619G	265
620G	265
622G	266
623G	266
624G	266
625G	266
626G	266
1200G	267
1201G	267
1202G	267
1203G	267
1204G	267
1205G	267
1206G	267
1207G	268
1208G	268
1209G	268
1210G	268
1211G	268
1212G	269
1213G	269
1214G	269
1215G	269
1216G	269
1217G	269
1218G	270
1219G	270
1220G	270
1221G	270
1241G	270
1242G	270
1243G	270
1244G	271
1245G	271
1246G	271
1247G	271
1248G	271
1249G	271
1250G	272
1251G	272
1252G	272
1253G	272

REF.	PAG.
1254G	272
1255G	272
1256G	272
1600G	273
1601G	273
1602G	273
1603G	273
1604G	273
1605G	273
1606G	273
1607G	273
1608G	274
1609G	274
1610G	274
1611G	274
1612G	274
1613G	274
1614G	275
1615G	275
1616G	275
1617G	275
1618G	275
1619G	275
1620G	275
1621G	276
1622G	276
1623G	276
1624G	276
1625G	276
1626G	276

## A

A 1(L)	347
A 1(N)	347
A-0G	342
A-0G(CV)	342
A-1G	342
A-1G(CV)	342
A-1G-1	342
A-1G-2	342
A-1G-3	342
A-1G-4	342
A-1G-5	342
A-1G-6	342
A-2G	342
A-2G(CV)	342
A-2G-1	342
A-3G	342
A-3G(CV)	342
A-4G	342
A-5G	342
AA-1G	343
AA-1G(CV)	343
AA-2G	343
AA-2G(CV)	343
AA-3G	343
AA-3G(CV)	343
AB- 1D	2-160
AB- 1I	2-160
AB- 1T	2

REF.	PAG.
AB- 2D	2-160
AB- 2I	2-160
AB- 2T	2
AB- 3I	2
AB- 3T	2
AB- 4D	160
AB- 4T	2
AB- 5D	3-160
AB- 5I	3-160
AB- 6D	3-160
AB- 6I	3-160
AB- 7I	160
AB- 8D	3-160
AB- 8I	3-160
AB- 9D	3
AB-10I	160
AB-11	3
ABA-1	1
ABC-1	1
ABC-2	1
ABC-3D	1
ABC-5D	1
ABC-5I	1
ABC-6	2
ABC-7	2
ABL-1	2
ABL-2	2
ABL-3	2
ABL-4	2
ABL-5	2
ABL-6	2
ABU- 1	3
ABU- 1D	3
ABU- 2D	3
ABU- 2G	330
ABU- 2I	3
ABU- 3	3
ABU- 4D	3
ABU- 4I	3
ABU- 5D	3
ABU- 6D	3
ABU- 6I	3
ABU- 7D	3
ABU- 8D	3
ABU- 8I	3
ABU- 9D	3
ABU- 9I	3
ABU-10D	3
ABU-10I	3
ABU-11	4
ABU-11D	4
ABU-12D	3
ABU-12I	3
ABU-13	4
ABU-13D	4
ABU-14	3
ABU-15	3
ABU-15D	3
ABU-16	4
ABU-17	4



# ÍNDICE GENERAL

## GENERAL INDEX

REF.	PAG.	REF.	PAG.	REF.	PAG.	REF.	PAG.	REF.	PAG.
ABU-17D	4	ABU-70	4	ADPLE-55	282	AGA- 1T	7	AGB-2	9
ABU-18DP	4-160	ABU-71D	3	ADS-1D	7	AGA- 2G	330	AGB-3	9
ABU-18P	4-160	ABU-72P	6-160	AEP-1D	7	AGA- 2T	7	AGB-3D	9
ABU-19D	4-160	ABU-73D	6	AEP-2D	7	AGA- 3G	330	AGB-4	9
ABU-19DP	4-160	ABU-74	3	AF- 1D	224	AGA- 3I	7	AGB-5	9
ABU-19P	4-160	ABU-74D	3	AF- 1I	224	AGA- 4D	7	AGD-1	9
ABU-20	3	ABU-75D	6	AF- 2D	224	AGA- 4G	334	AGD-1X	246
ABU-21	4	ABU-76	3	AF- 2I	224	AGA- 4I	7	AGD-2	9
ABU-22D	4	ABU-77	4	AF- 3D	224	AGA- 5D	7	AGD-2X	246
ABU-23D	4	ABU-78	6	AF- 3I	224	AGA- 5G	330	AGE-1I	9
ABU-24D	4	ABU-79	6	AF- 4D	224	AGA- 5I	7	AGE-2D	10
ABU-25D	5	ABU-80	4	AF- 4I	224	AGA- 6D	7	AGU-1D	10
ABU-26D	5	ABU-81	6	AF- 5D	224	AGA- 6G	334	AHR-2	10
ABU-27	5	ABU-83	4	AF- 5I	224	AGA- 6I	7	AHR-3	10
ABU-27D	5	ABU-84D	7	AF- 6D	224	AGA- 7	7	AIZ-1	10
ABU-28	5	ABU-85	4	AF- 6I	224	AGA- 7G	334	AIZ-2D	10
ABU-29P	5	ABU-86D	7	AF- 7D	226	AGA- 8D	8	AKA-1PG	293
ABU-30	5	AC- 9	349	AF- 7I	226	AGA- 8G	334	AKS-1	161
ABU-30D	5	AC-12	349	AF- 7IP	226	AGA- 9G	334	AL-1I	10
ABU-32D	5	AC-14	349	AF- 7IP1	226	AGA- 9I	8	AL-2	10
ABU-34	5	AC-15	349	AF- 8D	226	AGA-10	8	AL-3	10
ABU-35P	5-160	AD- 1	281	AF- 8DP	226	AGA-11	8	ALA-1X	246
ABU-36P	5-160	AD- 2	281	AF- 8I	226	AGA-12	8	ALC-1D	11
ABU-37D	3	AD- 3	281	AF- 8IP	226	AGA-13I	8	ALE-1	10
ABU-38D	5	AD- 4	281	AF- 9D	226	AGA-14D	8	ALE-1D	10
ABU-39P	5	AD- 5	281	AF- 9DP	226	AGA-15	8	ALE-1G	330
ABU-40	5	AD- 6	281	AF- 9I	226	AGA-15G	339	ALF- 1	11
ABU-41	6	AD- 7	281	AF- 9IP	226	AGA-16I	8	ALF- 2	11
ABU-41D	6	AD- 8	281	AF-10	224	AGA-18D	7	ALF- 3	11
ABU-42	6	AD- 9	281	AF-11	224	AGA-18I	7	ALF- 4	11
ABU-42D	6	AD-10	281	AF-12	224	AGA-19D	7	ALF- 5	11
ABU-43D	3	AD-11	281	AF-13	179	AGA-19I	7	ALF- 6	11
ABU-44	3	AD-12	281	AF-13P	179	AGA-20	8	ALF- 7	11
ABU-45	5	AD-13	281	AF-14	179	AGA-22	8	ALF- 8	11
ABU-46	3	AD-16	281	AF-14P	179	AGA-23	8	ALF- 8D	11
ABU-46D	3	AD-17	281	AF-19	224	AGA-23G	339	ALF- 9	11
ABU-47	3	AD-18	281	AF-19P	224	AGA-24D	8	ALF-10	11
ABU-48	4	AD-19	281	AF-21	224	AGA-24I	8	ALF-10D	11
ABU-49	3	AD-20	281	AF-21P	224	AGA-25	8	ALF-11D	11
ABU-50	6	AD-21	281	AG- 1D	10	AGA-27G	339	ALF-12D	11
ABU-51D	6	AD-23	281	AG- 1I	10	AGA-29	8	ALF-13D	11
ABU-52D	3	AD-24	281	AG- 3D	10	AGA-35G	339	ALF-14D	11
ABU-53	3	AD-25	281	AG- 3I	10	AGA-38	8	ALF-15	11
ABU-54	6	AD-26	281	AG- 4D	10	AGA-39	9	ALF-16	11
ABU-54D	6	AD-27	281	AG- 4I	10	AGA-40G	339	ALF-17	11
ABU-55	3	AD-28	281	AG- 5D	10	AGA-42	8	ALF-18	11
ABU-55D	3	AD-29	281	AG- 5I	10	AGA-43	9	ALF-19	11
ABU-57	6	AD-33T	330	AG- 6D	10	AGA-44	9	ALF-20	11
ABU-57D	6	AD-44-1	281	AG- 6I	10	AGA-46G	340	ALF-21	11
ABU-58D	4	AD-44-2	281	AG- 8D	10	AGA-48	8	ALF-22D	11
ABU-60	6	AD-44-3	281	AG- 8I	10	AGA-48G	340	ALF-23	11
ABU-61	6	AD-44-4	281	AG- 9D	10	AGA-49	9	ALF-24	11
ABU-63	6	AD-44-5	281	AG- 9I	10	AGA-49G	340	ALF-25	11
ABU-64P	6-160	AD-44-6	281	AG-10D	10	AGA-50	9	ALF-26	11
ABU-65P	6-160	AD-46	334	AG-10I	10	AGA-50G	340	ALF-27	11
ABU-66	6	AD-47	334	AG-11	10	AGA-51	9	ALF-28	11
ABU-67	3	ADPLE-11	282	AG-11D	10	AGA-52	9	ALF-29	11
ABU-67D	3	ADPLE-22	282	AGA- 1G	283	AGB-1	9	ALF-30	11
ABU-68	6	ADPLE-33	282	AGA- 1I	7	AGB-1D	9	ALF-31	11
ABU-69	3	ADPLE-44	282						

REF.	PAG.	REF.	PAG.	REF.	PAG.	REF.	PAG.	REF.	PAG.
ALF-32D	11	ARC- 1G	330	AS - 7D	15	AS -FM7	16	AS -RH7	16
ALF-33	11	ARC- 2G	330	AS - 8D	15	AS -G5	16	AS -RK7	16
ALF-34	11	ARC- 3G	331	AS - 9D	15	AS -G7	16	AS -RN7	16
ALF-35	11	ARC- 4G	331	AS -10D	15	AS -GG7	16	AS -RR7	16
ALF-36	11	ARC- 5G	331	AS -11D	15	AS -GK5	16	AS -S7	16
ALI-1	37	ARC- 6G	331	AS -12D	15	AS -GK7	16	AS -SS7	16
ALP-1D	11-161	ARC- 7G	331	AS -13D	15	AS -GL5	16	AS -T5	16
ALP-1I	11-161	ARC- 8G	331	AS -14D	15	AS -GL7	16	AS -T7	16
ALP-2	11-161	ARC-10G	331	AS -15D	15	AS -GM5	16	AS -TT7	17
ALP-2D	11-161	ARC-11G	331	AS -16D	15	AS -GM7	16	AS -U5	16
ALP-3	11	ARC-12G	331	AS -17D	161	AS -H7	16	AS -U7	16
ALP-4D	11	ARC-13G	331	AS -18D	15	AS -HH7	17	AS -UU7	17
ALP-5D	11	ARC-14G	331	AS -19D	161	AS -K7	16	AS -V5	16
ALP-6	11-161	ARC-15G	331	AS -20D	15	AS -KA7	17	AS -V7	16
ALP-6D	11-161	ARC-16G	331	AS -21	161	AS -KD7	17	AS -VV7	17
AMA-1	11	ARC-17DP	14	AS -21D	161	AS -KE5	17	AS -W5	16
AMA-1D	11	ARC-17P	14	AS -21DP	161	AS -KE7	17	AS -W7	16
AMB-1	1	ARC-18PG	331	AS -21P	161	AS -KF7	17	AS -WW7	17
AMB-1D	1	ARC-19PG	331	AS -22	15	AS -KG7	17	AS -X7	16
AME -1	12	ARC-20PG	332	AS -23	15	AS -KK7	16	AS -XX7	17
AME -2	12	ARC-21PG	332	AS -23D	15	AS -L7	16	AS -Z7	16
AME -4	12	ARC-22PG	332	AS -24	161	AS -LA7	17	ASH-2	15
AMG- 1	12	ARC-23PG	332	AS -24D	161	AS -LD7	17	ASI-1	15
AMG- 2D	12	ARC-24G	332	AS -25D	15	AS -LE7	17	ASP-1D	15
AMG- 3D	12	ARC-25G	332	AS -28	15	AS -LF7	17	ATA-1	11
AMG- 4D	12	ARC-26G	331	AS -A5	16	AS -LG7	17	ATA-1D	11
AMG- 5D	12	ARC-27PG	332	AS -A7	16	AS -M5	16	ATR-1G	293
AMG- 8D	12	ARE-1D	14	AS -AK5	16	AS -M7	16	ATR-2G	294
AMG- 9D	12	ARFE-1D	14	AS -AK7	16	AS -MA7	17	ATR-2TG	294
AMG-10	12	ARFE-1I	14	AS -AL5	16	AS -MD7	17	AU -1	185
AMG-10D	12	ARFE-3D	14	AS -AL7	16	AS -ME5	17	AU -AH	186
AMM-1	161	ARN-1	14	AS -AM5	16	AS -ME7	17	AU -AHP	186
AMM-2	161	ARN-2	14	AS -AM7	16	AS -MF7	17	AU -AHP1	186
ANA-1	13	ARN-2D	14	AS -B5	16	AS -MG5	17	AU -AN	186
ANA-1D	13	ARN-3	14	AS -B7	16	AS -MG7	17	AU -ANP	186
ANC-1D	12	ARN-3D	14	AS -BK5	16	AS -MM5	16	AU -C	186
ANC-2	13	ARO-1D	14	AS -BK7	16	AS -MM7	16	AU -HV	186
ANK- 1	13	ARR-1	14	AS -BL7	16	AS -N5	16	AU -HVP	186
ANK- 2	13	ARR-2	14	AS -BM7	16	AS -N7	16	AU -HVP1	186
ANK- 3	13	ARR-3	14	AS -D7	16	AS -NN5	16	AU -W	186
ANK- 4	13	ARR-7D	14	AS -DD7	17	AS -NN7	16	AUM-2D	17
ANK- 6	13	ARR-8	14	AS -DK5	16	AS -P5	16	AV-1	17
ANK-17	13	ARR-9D	14	AS -DK7	16	AS -P7	16	AV-1D	17
ANK-47D	13	ARS-1D	15	AS -DL5	16	AS -PA7	17	AV-2D	17
ANK-65	13	AS - 1D	161	AS -DL7	16	AS -PB7	17	AX-1	161
ANT-1G	293	AS - 1G	283	AS -DM5	16	AS -PF7	17	AX-1D	161
ANT-2G	293	AS - 1I	161	AS -DM7	16	AS -PG7	17	AX-1DP	162
ANT-3G	293	AS - 2D	161	AS -E5	16	AS -PH7	17	AX-1P	162
ANT-4G	293	AS - 2G	283	AS -E7	16	AS -PN7	17	AX-2P	162
ANT-5G	293	AS - 2I	161	AS -EK5	16	AS -PP7	16	AX-2P1	162
AP-1D	13	AS - 3D	15	AS -EK7	16	AS -PR7	17	AX-3DP	162
AP-2D	13	AS - 3G	283	AS -EL5	16	AS -PT7	17	AX-4DP	162
AP-3D	13	AS - 3I	15	AS -EL7	16	AS -R7	16	AYP-1G	332
AP-4D	13	AS - 4D	15	AS -EM5	16	AS -RA7	16	AZ- 1D	17
AP-5D	14	AS - 4G	293	AS -EM7	16	AS -RB7	16	AZ- 1I	17
APEC-1G	334	AS - 5D	15	AS -F5	16	AS -RC7	16	AZ- 2D	17
APEC-2G	335	AS - 5G	332	AS -F7	16	AS -RD7	16	AZ- 2I	17
AR-1D	14	AS - 6D	15	AS -FK5	16	AS -RE7	16	AZ- 3D	17
AR-4DP	14	AS - 6G-1	283	AS -FK7	16	AS -RF7	16	AZ- 3I	17
AR-4IP	14	AS - 6G-2	284	AS -FL7	16	AS -RG7	16	AZ- 4	17

# ÍNDICE GENERAL

## GENERAL INDEX

REF.	PAG.	REF.	PAG.	REF.	PAG.	REF.	PAG.	REF.	PAG.
AZ- 6	17	BCZ-2	20	BK- 9	23	BK-18/20	24	BLU-1X	246
AZ- 7	18	BD-1	18	BK-14	23	BK-18/21	24	BLU-2X	246
AZ- 8D	18	BDA-1	20	BK-16/ 0	23	BK-18/22	24	BM -1P	186
AZ- 9	18	BE- 1	21	BK-16/ 1	23	BK-18/23	24	BM -2	186
AZ- 9D	18	BE- 1G	294	BK-16/ 2	23	BK-18/24	24	BM -2P	187
AZ-10	18	BE- 3G	294	BK-16/ 3	23	BK-18/25	24	BM -3	187
AZ-12	18	BE- 4D	21	BK-16/ 4	23	BK-18/26	24	BM -3P	187
AZ-14	18	BE- 4G	294	BK-16/ 5	23	BK-18/27	24	BM -4	187
AZ-17	18	BE- 4I	21	BK-16/ 7	23	BK-18/28	24	BM -5P	187
AZ-17D	18	BE- 5D	21	BK-16/ 9	23	BK-18/29	24	BM -6P	187
AZ-18	18	BE- 5G	294	BK-16/10	23	BK-18/30	24	BM -6P1C1	187
AZ-18D	18	BE- 5I	21	BK-16/13	23	BK-18/31	24	BM -B	187
AZ-29	18	BE- 6G	294	BK-16/14	23	BK-18/32	24	BM -HB	187
AZ-32	18	BE- 7G	294	BK-16/15	23	BK-18/33	24	BM -HBP	187
AZ-37	18	BE-10G	295	BK-16/16	23	BK-18/34	24	BM -HBP1	187
AZ-37D	18	BES- 1D	21	BK-16/17	23	BK-18/35	24	BM -NB	187
AZKO-1I	18	BES- 2D	21	BK-16/18	23	BK-19/ 1	24	BM -NBP	187
		BES- 3D	21	BK-16/19	23	BK-19/ 2	24	BM -W	187
		BES- 4D	21	BK-16/20	23	BK-19/ 4	24	BMB-1	24
		BES- 5D	21	BK-16/21	23	BK-19/ 5	24	BMB-2	24
		BES- 6D	21	BK-16/23	23	BK-19/ 6	24	BMB-3D	24
		BES- 7D	21	BK-16/30	23	BK-19/ 7	24	BMC-1G	295
		BES- 8D	21	BK-17/1	23	BK-19/ 8	24	BOB-1D	163
		BES- 9D	21	BK-17/1PZ	23	BK-19/10	24	BOD-1	24
		BES-10D	21	BK-17/2	23	BK-19/11	24	BOD-1G	295
		BES-11D	21	BK-17/2PZ	23	BK-19/12	24	BOD-2G	295
		BES-12D	21	BK-17/3	23	BK-19/13	24	BOD-3G	295
		BES-13D	21	BK-17/4	23	BK-19/14	24	BOD-4G	284
		BES-14D	21	BK-17/4PZ	23	BK-19/15	24	BOD-5G	284
		BES-15D	21	BK-17/5	23	BK-19/16	24	BOG-1G	295
		BES-16D	21	BK-17/5PZ	23	BK-19/19	24	BOG-2G	295
		BES-17D	21	BK-17/6	23	BK-19/20	24	BOM-1	25
		BEY-1D	21	BK-17/6PZ	23	BK-19/21	24	BOM-1D	25
		BEY-2D	21	BK-17/7	23	BK-19/23	24	BOM-2	25-163
		BH-1	163	BK-17/7PZ	23	BK-19/25	24	BOM-2D	25-163
		BH-1P	163	BK-17/8	23	BK-19/26	24	BON-3G	262
		BH-2	163	BK-17/8PZ	23	BK-19/27	24	BOX-1G	295
		BH-3	163	BK-17/9	23	BK-19/31	24	BRA-1	99
		BH-4	163	BK-17/9PZ	23	BK-19/32	24	BRA-2	25-163
		BH-5	163	BK-17D/1PZ	23	BK-20	24	BRAS -1	25
		BH-6	163	BK-17D/2PZ	23	BK-21/ 1	22	BRI- 1D	25
		BH-8	163	BK-17D/3PZ	23	BK-21/ 2	22	BRI- 1I	25
		BI-1D	21	BK-17D/4PZ	23	BK-21/ 7	22	BRI- 1X	246
		BI-2	22	BK-18/ 1	24	BK-21/ 9	22	BRI- 2D	25
		BI-3D	22	BK-18/ 2	24	BK-21/14	22	BRI- 2I	25
		BIE-1	22	BK-18/ 3	24	BK-21/17	22	BRI- 2X	246
		BIF-1	22	BK-18/ 4	24	BK-21/19	22	BRI- 3D	25
		BIL-1T	22	BK-18/ 5	24	BKY-1	25	BRI- 3I	25
		BK- 1D	22	BK-18/ 6	24	BKY-2	25	BRI- 3X	246
		BK- 1I	22	BK-18/ 7	24	BL-1D	162	BRI- 4D	25
		BK- 2D	22	BK-18/ 9	24	BL-1I	162	BRI- 4I	25
		BK- 3D	22	BK-18/10	24	BL-2	162	BRI- 6D	25
		BK- 4	22	BK-18/11	24	BL-3	162	BRI- 6I	25
		BK- 4D	22	BK-18/12	24	BL-4	162	BRI- 6L 1	284
		BK- 5D	22	BK-18/13	24	BL-4D	162	BRI- 6L 2	284
		BK- 5I	22	BK-18/14	24	BL-5	162	BRI- 6L 7	284
		BK- 6D	22	BK-18/15	24	BL-5D	162	BRI- 6L 8	284
		BK- 6I	22	BK-18/16	24	BL-6	162	BRI- 6L11	284
		BK- 7D	22	BK-18/17	24	BL-6D	162	BRI- 6L12	284
		BK- 8D	23	BK-18/18	24	BLT-1	20	BRI- 6L17	284



REF.	PAG.	REF.	PAG.	REF.	PAG.	REF.	PAG.	REF.	PAG.
BRI- 6L18	284	BTV-2I	27	BUR-33	30	CE- 12D	33	CE- 70	34
BRI- 6L21	284	BTV-3	27	BUR-34	30	CE- 13D	33	CE- 71	34
BRI- 6L22	284	BU-1D	30	BUS-1	30	CE- 14D	33	CE- 72	34
BRI- 6L29	284	BU-1I	30	<b>C</b>		CE- 15D	33	CE- 73	34
BRI- 6L30	284	BUL-1	27	C	30	CE- 16D	33	CE- 74	34
BRI- 7D	25	BUL-2D	27	C-2	31	CE- 17D	33	CE- 75	34
BRI- 8I	25	BUL-3D	27	C-3G	343	CE- 18D	33	CE- 76	34
BRI- 9D	25	BUL-4D	27	C-3G(CV)	343	CE- 19D	33	CE- 77	34
BRI-10	26	BUL-5D	28	CA- 1I	31	CE- 20D	33	CE- 78	34
BRI-12	26	BUL-6D	27	CA- 2I	31	CE- 21D	33	CE- 79	34
BRI-13	25	BUL-7D	28	CA- 3I	31	CE- 22D	33	CE- 80	34
BRI-14	25	BUR- 1D	28	CA- 4D	31	CE- 23D	33	CE- 81	34
BRI-14D	25	BUR- 1G	335	CA- 4I	31	CE- 24D	33	CE- 82	34
BRI-15	25	BUR- 1I	28	CA- 5I	31	CE- 25D	33	CE- 83	34
BRI-16	26	BUR- 1X	246	CA- 6D	31	CE- 26D	33	CE- 84	34
BRI-17	25	BUR- 2D	28	CA- 7	32	CE- 27D	33	CE- 85	34
BRI-18	26	BUR- 2I	28	CA- 7D	32	CE- 28D	33	CE- 86	34
BRI-18D	26	BUR- 2X	247	CA- 8D	32	CE- 29D	33	CE- 87	34
BRI-19	26	BUR- 3	28	CA- 8I	32	CE- 30D	33	CE- 88	34
BRI-20	25	BUR- 3D	28	CA- 9I	31	CE- 31D	33	CE- 89	34
BRI-21	25	BUR- 3X	247	CA-10I	31	CE- 32D	33	CE- 89D	34
BRI-22	26	BUR- 4	28	CA-11I	31	CE- 33D	33	CE- 90D	34
BRI-23	26	BUR- 4D	28	CA-12I	31	CE- 34D	33	CE- 92	33
BRI-24	26	BUR- 4X	247	CA-13D	31	CE- 35D	33	CE- 92D	33
BRI-25	26	BUR- 5	28	CA-14D	32	CE- 36D	33	CE- 93D	33
BRI-26	26	BUR- 5D	28	CA-14D	32	CE- 37D	33	CE- 94	34
BRI-27	26	BUR- 5X	247	CA-15I	32	CE- 38D	33	CE- 96	34
BRI-28	26	BUR- 6	28-164	CAB-1D	30	CE- 39D	33	CE- 97	34
BRI-29	26	BUR- 7	28	CAF-1G	296	CE- 40D	33	CE- 98D	35
BRI-30	26	BUR- 8D	28	CAF-2G	296	CE- 41D	33	CE- 99D	33
BRI-31	26	BUR- 9	28	CAM-1D	164	CE- 42D	33	CE-100D	33
BRI-32D	26	BUR- 9D	28	CAS -1D	164	CE- 43D	33	CE-101D	33
BRI-33	26	BUR-10	28	CAT-1P	164	CE- 44D	33	CE-102	35
BRI-34	26	BUR-10D	28	CAT-2	164	CE- 45D	33	CE-103	35
BRR-1	20	BUR-11D	29	CAT-3	164	CE- 46D	33	CE-104D	35
BRS-1	25	BUR-12	29	CAY-1D	32	CE- 47D	33	CE-105	35
BRU -1	26	BUR-13D	29	CAY-1I	32	CE- 48D	33	CE-106	35
BRU -1D	26	BUR-14	29	CAY-2	32	CE- 49	34	CE-107	35
BS-1I	163	BUR-14D	29	CCF- 1X	247	CE- 49D	34	CE-108	33
BS-2	164	BUR-15	29	CCF- 5X	247	CE- 50	34	CE-109D	35
BS-4D	164	BUR-16	29	CCF- 8X	247	CE- 51	34	CE-110	33
BS-5	164	BUR-17	29	CCF- 9X	247	CE- 51D	34	CE-111D	35
BS-6	164	BUR-17D	29	CCF-10X	248	CE- 52	34	CE-114	35
BS-7	164	BUR-18D	29	CE- 1D	33	CE- 53D	34	CE-117D	35
BS-7D	164	BUR-19D	29	CE- 1I	33	CE- 54	34	CE-118D	33
BS-8	164	BUR-20D	29	CE- 2D	33	CE- 55	34	CE-130	35
BS-8D	164	BUR-21D	29	CE- 2I	33	CE- 56	34	CE-131D	35
BS-9	164	BUR-22D	29	CE- 3D	33	CE- 57	34	CE-132/15	35
BS-9D	164	BUR-23D	29	CE- 3I	33	CE- 58	34	CE-132/16	35
BSS-1D	26	BUR-24	29	CE- 4D	33	CE- 59	34	CE-132/17	35
BSS-2	26	BUR-24D	29	CE- 5	33	CE- 60	34	CE-132/18	35
BSS-2D	26	BUR-25D	29	CE- 5D	33	CE- 61	34	CE-132/25	35
BSS-3	27	BUR-26D	30	CE- 6D	33	CE- 62	34	CE-132/26	35
BSS-4D	27	BUR-27D	28	CE- 6I	33	CE- 63	34	CE-132/27	35
BSS-5D	27	BUR-28	30	CE- 7D	33	CE- 64	34	CE-132/35	35
BSS-6D	27	BUR-29	30	CE- 7I	33	CE- 65	34	CE-132/36	35
BSS-7D	27	BUR-29D	30	CE- 8D	33	CE- 66	34	CE-132/37	35
BTV-1D	27	BUR-30D	164	CE- 9D	33	CE- 67	34	CE-132/38	35
BTV-1I	27	BUR-31D	30	CE- 10D	33	CE- 68	34	CE-132/45	35
BTV-2D	27	BUR-32D	30	CE- 11D	33	CE- 69	34	CE-132/46	35

# ÍNDICE GENERAL

## GENERAL INDEX

REF.	PAG.	REF.	PAG.	REF.	PAG.	REF.	PAG.	REF.	PAG.
CE-134	35	CHU - 1G	284	CI -32	38	CIS-1D	31	COR- 7	41
CE-135D	35	CHU - 2G	284	CI -33	38	CIS-1I	31	COR- 8	41
CEM-BP	164	CHU - 4G	297	CI -34	39	CIS-2	31	COR- 9	41
CEM-JC	165	CHU - 5G	297	CI -34D	39	CIS-3	31	COR- 10	41
CENT-1D	32	CHU -10	36	CI -35	38	CIS-4	31	COR- 11	41
CENT-1I	32	CI - 1D	37	CI -36	39	CIS-5	31	COR- 11D	41
CENT-2D	32	CI - 1G	298	CI -38D	39	CIS-6D	31	COR- 12	41
CENT-2I	32	CI - 1I	37	CI -39D	37	CIS-7D	31	COR- 13	41
CENT-3D	32	CI - 1PG	298	CI -3PG	298	CIS-803-1	340	COR- 13D	41
CENT-4	32	CI - 2	39	CI -41	39	CIS-803-2	340	COR- 15D	41
CER-1	32	CI - 2G	298	CI -42	39	CIS-803-3	340	COR- 16D	41
CER-1G	314	CI - 2I	39	CI -43D	39	CIS-803-4	340	COR- 17D	41
CER-2G	314	CI - 3D	37	CI -44D	38	CIS-803-5	340	COR- 18D	41
CER-3G	314	CI - 3G	298	CI -45D	39	CIS-803-6	340	COR- 19D	41
CER-4G	314	CI - 4D	37	CI -46D	39	CL-1I	40-166	COR- 20	41
CF-1D	36	CI - 4DP	37	CI -48	39	CL-2D	166	COR- 20-25	42
CF-1I	36	CI - 4G	298	CI -49	39	CL-2I	166	COR- 20D	41
CHA-2	36	CI - 4I	37	CI -51	39	CL-3I	167	COR- 21D	41
CHA-2D	36	CI - 4IP	37	CI -51D	39	CL-4I	167	COR- 22D	41
CHEK-1	36	CI - 5DP	38	CI -53	39	CL-5D	167	COR- 23D	42
CHI- 1	36	CI - 5IP	38	CI -55D	39	CL-6	167	COR- 24	42
CHI- 1T	36	CI - 5PG	298	CI -56	38	CL-6P	167	COR- 24D	42
CHI- 2	36	CI - 6D	38	CI -57	39	CL-7P	167	COR- 25	42
CHI- 3	36	CI - 6G	298	CI -58D	38	CL-8P	167	COR- 25I	42
CHI- 4	36	CI - 6I	38	CI -59	38	CL-9P	167	COR- 26	42
CHI- 5	36	CI - 6PG	299	CI -60	38	CLA-3G	299	COR- 27D	42
CHI- 6	36	CI - 7D	38	CI -61	39	CLF-1	40	COR- 28	42
CHI- 7D	36	CI - 7TG	299	CI -62	39	CLI-1D	167	COR- 29D	42
CHI- 8D	36	CI - 8D	39	CI -62D	39	CLK-1	44	COR- 30	42
CHI- 9D	36	CI - 8G	299	CI -63	39	CLS-1D	40	COR- 31	42
CHI-10D	36	CI - 9D	39	CI -63D	39	CLU-1D	167	COR- 32	42
CHI-12D	36	CI - 9PG	299	CI -64D	39	CLU-1I	167	COR- 33	42
CHR- 1	165	CI -10D	39	CI -65	39	CLU-2	167	COR- 34	42
CHR- 2	165	CI -10G	298	CI -66D	39	CLU-3	167	COR- 35	43
CHR- 3	165	CI -11D	39	CI -67	38	CLU-4	167	COR- 36D	41
CHR- 3P	165	CI -12	39	CI -69	39	CLU-5	167	COR- 37	43
CHR- 4D	222	CI -12TG	299	CI -70	39	CMA-1	32	COR- 40	43
CHR- 4I	222	CI -13	39	CI -71	39	CMA-1D	32	COR- 48	41
CHR- 5	165	CI -13G	299	CI -72	39	CMA-2	32	COR- 49	41
CHR- 6	165	CI -14	38	CI -73	39	CMA-2D	32	COR- 50-60	43
CHR- 6D	165	CI -14G	299	CI -DL	39	CML-1	30	COR- 50-60I	43
CHR- 7	165	CI -15	39	CI -IL	39	CN-1D	165	COR- 62	43
CHR- 7P	165	CI -15D	39	CIE-1D	36	CO -1D	43	COR- 64	41
CHR- 8	165	CI -16D	39	CIF-1D	37	CO -M	44	COR- 65	41
CHR- 8P	165	CI -17	38	CIF-1X	248	COB-1	167	COR- 66	41
CHR- 9	165	CI -18	39	CIF-2D	37	COB-1P	168	COR- 67	41
CHR- 9P	165	CI -19D	38	CIF-3	37	COB-2	168	COR- 68	41
CHR-10	166	CI -20	38	CIF-3D	37	COH-1	40	COR- 69	41
CHR-10P	166	CI -20D	38	CIF-4	37	COH-2	40	COR- 70D	43
CHR-11	166	CI -21	38	CIL-1	37	COH-2D	40	COR- 71	41
CHR-11P	166	CI -22D	38	CIL-1D	37	COH-3	40	COR- 72	41
CHR-12	166	CI -23D	38	CIL-2D	37	COH-4	40	COR- 73	41
CHR-13D	166	CI -24	38	CIL-3D	37	COM-1D	40	COR- 74	41
CHR-14	166	CI -25	38	CIL-4	37	COR- 1D	41	COR- 76D	41
CHR-14P	166	CI -26	38	CIL-4D	37	COR- 1GD	41	COR- 77	43
CHR-15	166	CI -27	39	CIL-5D	37	COR- 1I	41	COR- 78	43
CHR-15P	166	CI -28D	38	CIN-1	37	COR- 2D	41	COR- 79	41
CHR-17	166	CI -29	39	CIN-1D	37	COR- 2I	41	COR- 80	41
CHTZ-1	36	CI -30	38	CIN-2	37	COR- 3	41	COR-114	43
CHU - 1D	36	CI -31	38	CIN-2D	37	COR- 3D	41	COR-115D	43

REF.	PAG.	REF.	PAG.	REF.	PAG.	REF.	PAG.	REF.	PAG.
COR-153	43	DAC-1DP	168	DAT- 9D	219	DMR-6-2	285	DOM-27/16	48
COR-223	43	DAC-2D	168	DAT- 9DP	219	DMR-6-2L	285	DOM-27/19	48
COT-1D	44	DAC-3DC1	168	DAT- 9I	219	DMR-6-3	285	DOM-27/35	48
CR- 1G	300	DAC-4DC1	168	DAT- 9IP	219	DMR-6-3L	285	DOM-27D/ 1	49
CR- 2G	300	DAC-5C1	168	DAT-10	219	DMR-6-4	285	DOM-27D/ 2	49
CR- 3G	300	DAD-1D	44	DAT-10P	220	DMR-6-4L	285	DOM-27D/ 3	49
CR- 4G	300	DAD-1I	44	DAT-11	220	DMR-7-1	285	DOM-27D/ 4	49
CR- 5G	300	DAD-2D	44	DAT-11D	220	DMR-7-2	285	DOM-27D/ 5	49
CR- 8G	300	DAD-2I	44	DAT-11DP	220	DMR-7-3	285	DOM-27D/ 6	49
CR-10G	300	DAD-3D	44	DAT-11P	220	DMR-7-4	285	DOM-27D/ 7	49
CR-11G	301	DAD-4D	44	DAT-12	220	DO-2I	51	DOM-27D/ 8	49
CR-12G	301	DAD-5D	44	DAT-13	220	DO-3	51	DOM-27D/ 9	49
CR-14G	301	DAD-6D	44	DAT-13P	220	DO-4	51	DOM-27D/10	49
CR-17TG	301	DAE-1P	168	DAT-14	220	DO-5	52	DOM-27D/11	49
CR-18G	301	DAE-2DP	168	DAT-14P	220	DO-5D	52	DOM-27D/12	49
CR-19G	301	DAE-3D	168	DAT-15	220	DO-7	52	DOM-27D/13	49
CRC-1X	248	DAE-3DP1	168	DAT-15C1	220	DOB-1	169	DOM-27D/14	49
CRN-1G	300	DAE-3DP2	169	DAT-15C2	220	DOB-1D	169	DOM-27D/15	49
CRO-1G	335	DAE-3P2	169	DAT-15P	220	DOB-2	169	DOM-27D/16	49
CRT- 1G	296	DAE-4D	168	DAT-16	220	DOB-2D	169	DOM-27D/17	49
CRT- 2G	296	DAE-4DP1	168	DAT-17	220	DOB-3	169	DOM-27D/18	49
CRT- 3G	296	DAE-4P1	168	DAT-17D	220	DOB-3D	169	DOM-27D/19	49
CRT- 4G	296	DAE-5P	169	DAT-18	221	DOI-1	51	DOM-27D/20	49
CRT- 7G	296	DAF-1	45	DAT-19	221	DOI-4	51	DOM-27D/21	49
CRT- 8G	296	DAF-1D	45	DAT-19P	221	DOL-1X	248	DOM-27D/22	49
CRT-10G	332	DAF-2	45	DAT-20	221	DOM- 1D	46	DOM-27D/23	49
CRT-11G	297	DAF-3D	45	DAT-20P	221	DOM- 1DP	47	DOM-27D/24	49
CRT-12G	297	DAF-4D	45	DAV-1	169	DOM- 1I	46	DOM-27D/25	49
CRT-13G	297	DAI-1P	169	DAV-1P	169	DOM- 2D	47	DOM-27D/26	49
CRT-14G	297	DAI-2D	169	DC-1D	52	DOM- 3D	47	DOM-27D/27	49
CRT-15G	297	DAL-1P	168	DC-2D	52	DOM- 3I	47	DOM-27D/28	49
CRT-17G	297	DAR-1	169	DC-3	52	DOM- 4	47	DOM-27D/29	49
CRT-18G	297	DAT- 1D	218	DC-4D	52	DOM- 4D	47	DOM-27D/30	49
CSB-1D	31	DAT- 1DP	218	DEB- 1X	248	DOM- 5D	47	DOM-27D/31	49
CSB-2D	31	DAT- 1I	218	DEB-12L	285	DOM- 6D	47	DOM-27D/32	49
CT-1	224	DAT- 1IP	218	DEF-1D	45	DOM- 6I	47	DOM-27D/33	49
CT-1P	224	DAT- 2D	218	DEK- 1G	302	DOM- 7D	47	DOM-27D/34	49
CT-2	224	DAT- 2DP	218	DEK- 2	45	DOM- 7I	47	DOM-27D/35	49
CT-2P	225	DAT- 2I	218	DEK- 3	45	DOM- 8D	47	DOM-27D/36	49
CT-2P1	225	DAT- 2IP	218	DEK- 4	45	DOM- 9	47-169	DOM-27D/37	49
CT-3	225	DAT- 3D	218	DEK- 6D	45	DOM- 9D	47-169	DOM-27D/38	49
CT-3P	225	DAT- 3I	218	DEK- 7D	45	DOM-10D	47	DOM-27D/39	49
CT-4P	225	DAT- 4D	218	DEK- 8	45	DOM-11D	47	DOM-27D/40	49
CUB-1	44	DAT- 4I	218	DEK- 9D	45	DOM-11I	47	DOM-27D/41	49
CVL-1D	44	DAT- 5D	218	DEK-10	45	DOM-12	47	DOM-27D/42	49
CVL-1I	44	DAT- 6	218	DEK-11	45	DOM-12D	47	DOM-27D/43	49
CVL-2D	44	DAT- 6C1	219	DEK-13	45	DOM-13D	47	DOM-27D/44	49
CVL-2I	44	DAT- 6D	218	DEK-14D	45	DOM-14D	47-170	DOM-27D/45	49
CVL-3D	44	DAT- 6DP	219	DIA-1	46	DOM-15D	48	DOM-27D/46	49
CVL-3I	44	DAT- 6DP1	219	DIA-2	46	DOM-16D	48	DOM-27D/47	49
CVL-4	44	DAT- 6P	219	DIA-3	46	DOM-17I	48	DOM-27D/48	49
CVL-5D	44	DAT- 6P1	219	DIE-1	46-349	DOM-18D	48	DOM-27D/49	49
CVL-5I	44	DAT- 7	218	DLC-1	46	DOM-20D	48	DOM-27D/50	49
CVL-6	44	DAT- 7P	219	DLC-2	46	DOM-21D	48	DOM-27D/51	49
CVL-8D	44	DAT- 7P1	219	DLC-3	46	DOM-22	48	DOM-27D/52	49
CVL-9D	44	DAT- 8	219	DLP-1	45	DOM-25D	48	DOM-27D/53	49
		DAT- 8I	219	DLP-2	46	DOM-26	48	DOM-27D/54	49
		DAT- 8IP	219	DM-1	46	DOM-26D	48	DOM-27D/55	49
		DAT- 8IP1	219	DMR-6-1	285	DOM-27/12	48	DOM-27D/56	49
		DAT- 8P	219	DMR-6-1L	285	DOM-27/13	48	DOM-27D/57	49

## D



# ÍNDICE GENERAL

## GENERAL INDEX

REF.	PAG.
DOM-27D/58	49
DOM-27D/59	49
DOM-27D/60	49
DOM-27D/61	49
DOM-28	49
DOM-28D	49
DOM-29	49
DOM-30	49
DOM-31	49
DOM-32	50
DOM-33	50
DOM-34	50
DOM-35	50
DOM-35D	50
DOM-36	50
DOM-36D	50
DOM-37	50
DOM-37D	50
DOM-38D	50-170
DOM-39	50
DOM-40D	50
DOM-41D	48
DOM-42	50
DOM-43	50
DOM-44D	48
DOM-45	48
DOM-46D	48
DOM-48	47
DOM-49D	48
DOM-51	50
DOM-52	50
DOM-53D	50
DOM-54D	50
DOM-55	51
DOM-55D	51
DOM-56D	51
DOM-57	51
DOM-57D	51
DOM-58D	50
DOM-59	51
DOM-60D	51
DOM-61	51
DOM-62D	51
DOM-63D	51
DOM-64D	51
DOM-65	51
DOM-66D	51
DOM-67D	51
DOM-68	51
DOM-71D	51
DOM-72D	50
DOM-73D	51
DOM-74D	50
DOM-B1	51
DR-1	46
DU-1	170
DUP-1G	335
DUR-1D	52
DV- 1G	302
DV- 2G	335

REF.	PAG.
DV- 3G	302
DV- 4G	335
DV- 5G	302
DV- 6G	302
DV- 7G	302
DV- 8G	302
DV- 9G	302
DV-10G	303
DV-10G-A	335
DV-11G	335
DV-12G	303
DV-13G	303
DV-13G-A	336
DV-14G	303
DV-15G	303
DV-16G	303
DV-17G	336
DV-18G	303
DV-19G	303
DX-5	46
DX-5D	46
DX-6	46
DX-6D	46
<b>E</b>	
E-0G	343
E-0G(CV)	343
E-1G	343
E-1G(CV)	343
E-2G	344
E-2G(CV)	344
E-3G	344
E-3G(CV)	344
EAG-2D	52
EC-1	52
EC-1D	52
ECH-1	170
EG-1	52
EG-2	52
EI-1D	52
EI-2D	52
ELB-1G	303
ELZ- 1D	53
ELZ- 1G	304
ELZ- 2	53
ELZ- 2G	285
ELZ- 3D	53
ELZ- 3G	285
ELZ- 4	53
ELZ- 4D	53
ELZ- 4G	304
ELZ- 5D	53
ELZ- 5G	286
ELZ- 6D	53
ELZ- 6G	286
ELZ- 7G	304
ELZ- 8D	53
ELZ- 9	53
ELZ-10	53
ELZ-10D	53

REF.	PAG.
ELZ-11D	53
ELZ-12	53
ELZ-12D	53
EMK-1	53
EP-1D	53
ER-1D	53
ER-1G	286
ER-2D	53
ER-3	54
ER-4D	54
ER-4G	286
ER-5G	286
ERV-1G	304
ERV-2G	304
ERV-3G	304
ERV-3G-A	336
ES-1D	54
ES-1G	286
ES-1I	54
ESL-1	54
ESL-1D	54
ESS-1	54
ESS-2	54
ESS-3	54
ESS-4	54
ESS-9D	54
EST- 1G	304
EST- 2G	304
EST- 3G	305
EST- 4G	305
EST- 5G	305
EST- 5TG	305
EST- 6G	305
EST- 7G	305
EST-10G	305
ETS-1D	54
EU- 1	54
EU- 2	55
EU- 3	55
EU- 4	55
EU- 4D	55
EU- 6	54
EU- 7	55
EU- 7D	55
EU- 8D	55
EU- 9	54
EU-10D	54
EU-11	55
EU-12	55-170
EU-13D	55
EU-14D	54
EUB-1	54
EUB-2	54
EUR-1D	54
EUT-1G	305
EUT-2G	306
EUT-3G	306
EV- 1	55
EV- 2	55
EV- 2I	55

REF.	PAG.
EV- 3D	55
EV- 3I	55
EV- 4D	55
EV- 6D	56
EV- 7D	56
EV- 8D	56
EV- 9D	56
EV-10	55
EV-11	56
EV-11D	56
EV-12D	56
EV-13D	55
EV-19	56
EV-20D	56
EV-23D	56
EV-24	56
EV-25D	55
EV-27D/ 1	56
EV-27D/ 2	56
EV-27D/ 3	56
EV-27D/ 4	56
EV-27D/ 5	56
EV-27D/ 6	56
EV-27D/ 7	56
EV-27D/ 8	56
EV-27D/ 9	56
EV-27D/10	56
EVE-1	55
EVE-1D	55
EVE-2D	55
EVE-3D	55
EVE-4	55
EX-1D	56
EXS-1D	56
EXS-2D	56
EXS-3	56
EXS-3D	56
EXS-4D	56
EXS-5	56
EXS-5D	56
EXS-6	56
EZ-1D	56
EZ-1G	306
EZ-1I	56
EZ-2G	306
EZ-2I	56
EZ-3D	57
EZ-3G	306
EZ-3I	57
EZ-4D	57
EZ-4G	306
EZ-4I	57
EZ-5G	306
EZ-6G	306
EZ-7G	306
EZ-8G	307
EZ-DS10	57
EZ-DS10E	57
EZ-DS15	57
EZ-DS15R	57

REF.	PAG.
<b>F</b>	
F1(L)	347
FA-1	59
FA-1D	59
FA-1G	286
FA-2G	286
FA-2PPG	286
FA-3G	287
FA-3PPG	287
FA-4G	287
FA-5G	287
FA-6G	287
FA-7G	287
FAB-1	170
FAB-2	170
FAC- 1D	58
FAC- 1G	307
FAC- 1I	58
FAC- 2D	58
FAC- 2G	307
FAC- 2I	58
FAC- 3D	58
FAC- 3G	307
FAC- 3I	58
FAC- 4D	58
FAC- 4G	307
FAC- 5D	58
FAC- 6D	58
FAC- 7D	58
FAC- 8D	58
FAC- 9D	58
FAC-10D	58
FAC-11D	58
FAC-12D	58
FAC-13D	58
FAC-14D	58
FAC-15	58
FAC-18	58
FAC-19	58
FAC-20D	58
FAC-21	59
FAC-21D	59
FAC-22D	59
FAC-23	59
FAC-24	59
FAI-A	171
FAI-B	171
FAI-C	171
FAI-D	171
FAIN-1I	59
FAL-1D	59
FAL-2D	59
FAM-1	59
FAM-2	59
FAN-1	59
FAN-1D	59
FAR-1D	171
FAR-1I	171
FAR-2D	171

REF.	PAG.	REF.	PAG.	REF.	PAG.	REF.	PAG.	REF.	PAG.
FAR-2I	171	FEM-3D	171	FI-16P1	234	FO -20D	173	FTH- 9	63
FAR-3	171	FEM-3I	171	FIA-1	171	FO -22P	173	FTH-10	63
FAR-3D	171	FER-1	60	FIA-2	171	FO -24C1	187	FTH-11D	63
FAR-4D	171	FET-1G	307	FIC- 1	61	FO -24C2	188	FTH-12D	64
FAS-1	59	FF- 1	60	FIC- 2	61	FO -35	173	FTH-13D	64
FAV-1D	59	FF- 1D	60	FIC- 5	61	FO -36	174	FTH-14D	64
FAV-2	59	FF- 2	60	FIC- 7	61	FO -ANP	174	FTH-15	64
FAY-1D	60	FF- 2D	60	FIC- 8	61	FO -D	174	FTH-16	64
FAY-1X	248	FF- 3	60	FIC- 9	61	FO -E-TC	174	FTH-17D	64
FB- 1	57	FF- 5D	60	FIC- 18	61	FO -E-TCP	174	FTH-18	64
FB- 2D	57	FF- 6	61	FIC-200	310	FO -FHP	174	FTH-19	64
FB- 2I	57	FF- 7D	61	FIC-401G	287	FO -FK	174	FTH-20D	64
FB- 3	57	FF- 8D	61	FIS-1D	62-171	FO -FKP	174	FTH-21	63
FB- 4	57	FF- 9D	61	FLO-1	62	FO -FR	174	FTH-22	63
FB- 5	57	FF-10D	60	FLO-1D	62	FO -FRP	174	FTH-23	64
FB- 6	57	FF-11	61	FLO-2D	171	FO -OA	174	FTH-25	64
FB- 7	57	FF-13	61	FM- 1G	308	FO -OL	174	FTH-26D	64
FB- 8	57	FI- 1	179	FM- 1X	248	FO -OR	174	FTH-27	65
FB- 9	57	FI- 1P	179	FM- 2G	308	FO -PN	174	FTH-28	65
FB-10	57	FI- 1P8	179	FM- 2X	248	FO -PRL	174	FTH-29	65
FB-11	57	FI- 2D	179	FM- 3G	308	FO -PRR	174	FTH-31	65
FB-12	57	FI- 2DP3	179	FM- 4G	308	FO -SR	188	FV-1D	60
FB-13	57	FI- 3	179	FM- 4TG	308	FO -TC	174		
FB-14	57	FI- 3D	179	FM- 5G	308	FO -TX	175		
FB-15	57	FI- 3DP	179	FM- 6G	308	FO -TX1	175	<b>G</b>	
FB-16	57	FI- 3DP1	179	FM- 7G	308	FO -TX1P	175	GAB-1D	65
FB-17	57	FI- 3DP2	179	FM- 8G	309	FO -TX2	175	GAB-1I	65
FB-18	57	FI- 3DP3	179	FM-13G	309	FO -TX2P	175	GAB-2	65
FB-19	57	FI- 3DP4	180	FM-14G	309	FO -TXP	175	GARD-1G	310
FB-20	57	FI- 3DP5	180	FM-15G	309	FO -XL	174	GAS -1	175
FB-21	57	FI- 4D	180	FM-16G	309	FO -XR	174	GAS -1D	175
FB-22	57	FI- 5D	180	FM-17G	309	FON-1E	62	GAT-1	65
FB-23	57	FI- 5I	180	FM-20G	309	FON-2E	62	GAT-2D	65
FB-24	57	FI- 6I	180	FM-21G	309	FON-3E	62	GAT-3D	65
FB-25	57	FI- 6IP	180	FO - 1	171	FON-4E	62	GBZ-1	65
FB-26	57	FI- 6IP1	180	FO - 2	172	FON-5E	62	GDA- 1P	67
FB-27	57	FI- 6IP2	180	FO - 3	171	FON-6E	62	GDA- 3D	67
FB-28	57	FI- 6IP3	180	FO - 3D	171	FON-6E	62	GDA-30D	67
FB-29	57	FI- 6IP4	179	FO - 3DP	172	FORTIS-2I	63	GDA-50D	67
FB-31	57	FI- 7I	180	FO - 3P	172	FR- 1D	62	GDA-60D	67
FB-32	57	FI- 8I	180	FO - 4P	172	FR- 2	62	GE- 1D	65
FB-33	57	FI- 8IP	180	FO - 5	165	FR- 4	62	GE- 2	65
FB-34	57	FI- 8IP1	180	FO - 6P	172	FR- 7D	62	GE- 3D	66
FB-35	57	FI- 9I	181	FO - 7P	172	FR- 8	62	GE- 4D	66
FB-38	57	FI- 9IP	181	FO - 8	172	FR- 9D	62	GE- 5	66
FB-39	57	FI-10	179	FO - 8D	172	FR-11D	62	GE- 5D	66
FB-41	57	FI-10P	179	FO - 8DP	172	FRI-1X	249	GE- 6	66
FCS-1D	61	FI-11	181	FO - 8DP1	172	FRI-2X	249	GE- 6D	66
FEB-1G	307	FI-11P	181	FO - 9D	172	FRI-3	63	GE- 7	66
FEB-2G	307	FI-12	179	FO - 9DP	172	FTE -1	62	GE- 8	66
FEC-1D	60	FI-12P	179	FO - 10P	172	FTE -1D	62	GE- 9	66
FEC-2	60	FI-12P1	179	FO -10D	172	FTH- 1	63	GE-10D	66
FEC-3D	60	FI-12P3	179	FO -11D	172	FTH- 1D	63	GE-11	66
FED-1	60	FI-13	181	FO -12	173	FTH- 2	63	GE-15D	66
FED-2	60	FI-13P	181	FO -12P	173	FTH- 3	63	GE-16D	66
FED-3	60	FI-13P1	181	FO -13DP	173	FTH- 4	63	GE-19	66
FEM-1D	171	FI-13P7	181	FO -14DP	173	FTH- 5	63	GE-21	66
FEM-1I	171	FI-14P	181	FO -15D	173	FTH- 6	63	GE-21D	66
FEM-2D	171	FI-15	181	FO -15DP	173	FTH- 7	63	GEA-1	66
FEM-2I	171	FI-16C1	234	FO -17P	173	FTH- 8	63	GEA-1X	249
				FO -18D	173	FTH- 8D	63	GEA-2D	66

# ÍNDICE GENERAL

## GENERAL INDEX

REF.	PAG.	REF.	PAG.	REF.	PAG.	REF.	PAG.	REF.	PAG.
GEA-3	66	GM - 4P1	176	GMT-3D	65	HAW-1D	71	HOND-16DP1	184
GEA-3X	249	GM - 5	176	GMT-4D	65	HAW-2D	71	HOND-17P	184
GEA-4D	67	GM - 5P	176	GMT-5D	65	HAW-3D	71	HOND-18DP	183
GEA-5D	67	GM - 6	176	GOD-1	69	HAW-4D	71	HOND-18P	183
GEA-6D	67	GM - 6P	176	GOD-2	69	HB-1	71	HOND-19	184
GEA-7D	67	GM - 7	176	GPS-1G	310	HD-1	182	HOND-19D	184
GEA-8D	67	GM - 7P	176	GPS-2G	310	HD-1D	182	HOND-19DP	184
GEB-1D	66	GM - 8	176	GPZ-1G	287	HD-2	182	HOND-19P	184
GG-1D	169	GM - 8P	176	GR-1D	70	HD-2D	182	HOND-20	184
GH-1	178	GM - 9	176	GR-1I	70	HD-3	182	HOND-20D	184
GH-2	178	GM - 9P	176	GR-2D	70	HD-3D	182	HOND-20DP	184
GH-3	178	GM - 10	176	GR-2I	70	HD-4D	182	HOND-20P	184
GH-GX	178	GM - 10P	176	GR-3D	70	HEK-1	71	HOND-22DP	184
GH-HX	178	GM - 11	176	GR-3I	70	HEK-2	71	HOND-23	184
GH-PS	178	GM - 11P	176	GR-4D	70	HEK-3	71	HOND-24DP	184
GIB-1D	67	GM - 12	176	GR-4I	70	HEK-4	71	HOND-24P	184
GIM-1TG	310	GM - 12P	176	GR-5D	70	HEL-1	71	HOND-25P2	182
GIOB-1D	181	GM - 13	176	GR-5I	70	HEN-1	71	HOND-26DP1	185
GIOB-1DP	181	GM - 13P	176	GR-6	70	HEN-1D	71	HOND-26P1	185
GIOB-2I	181	GM - 14	176	GR-6D	70	HEN-1GP	288	HOND-27D	185
GIOB-2IP	181	GM - 14P	176	GR-7	70	HEN-2	71	HOND-28DP	185
GIOB-3P	182	GM - 15D	176	GR-7D	70	HOB-1	72	HOND-28P	185
GIOB-3P2	182	GM - 15DP	176	GR-8	70	HOB-2D	72	HOND-29DP	185
GIU-1	67	GM - 16P	177	GRG-1	69	HOND- 1	182	HOND-29P	185
GIU-1D	67	GM - 17P	177	GTV- 1D	69	HOND- 1P	182	HOND-30DP2	182
GIU-2	67	GM - 18P	177	GTV- 2	69	HOND- 2	182	HOND-30P2	182
GIU-2D	67	GM - 19P	177	GTV- 2D	69	HOND- 2P	182	HOND-31P	185
GIU-3D	67	GM - 20P	177	GTV- 3D	69	HOND- 3D	182	HOND-42P	185
GIU-4	68	GM - 21	177	GTV- 4D	69	HOND- 3I	182	HOND-43	185
GLA-1D	68	GM - 21P	177	GTV- 5D	69	HOND- 4D	182	HOND-43D	185
GLA-2D	68	GM - 22	177	GTV-10	69	HOND- 4DP	182	HOND-43DP	185
GLO- 1D	68	GM - 22P	177	GTV-11	69	HOND- 4DP1	183	HOND-43P	185
GLO- 1I	68	GM - 23	177	GUA-1	69	HOND- 4DP2	182	HOND-45D	185
GLO- 2	68	GM - 23P	177	GUA-1D	69	HOND- 4I	182	HOND-46D	185
GLO- 2D	68	GM - 24	177	GUA-2	69	HOND- 4IP	182	HOND-49	185
GLO- 3	68	GM - 24P	177	GUA-2D	69	HOND- 4IP1	183	HOR-1	72
GLO- 3D	68	GM - 25	177	GUA-3	70	HOND- 5D	183	HOR-2	72
GLO- 4D	68	GM - 25P	177	GUA-3D	70	HOND- 5I	183	HOR-2D	72
GLO- 4I	68	GM - 26	178	GUR-1G	288	HOND- 6D	183	HRM-1	71
GLO- 5I	68	GM - 42	178	GW-1D	178	HOND- 6I	183	HT-1	72
GLO- 6	68	GM -A	178	<b>H</b>		HOND- 7D	183	HTE -1D	72
GLO- 6D	68	GM -AP	178	H-3G	344	HOND- 7I	183	HTE -50	72
GLO- 7	68	GM -B	178	H-3G(CV)	344	HOND- 8D	183	HU -1	188
GLO- 7D	68	GM -BP	178	HA-1D	182	HOND- 8I	183	HU -2P	188
GLO- 8	68	GM -C	178	HA-1I	182	HOND- 9D	183	HU -3	188
GLO- 8D	68	GM -CP	178	HAF-1	70	HOND- 9I	183	HU -AN	188
GLO- 9D	68	GM -D	178	HAF-1D	70	HOND-10	183	HU -DF	188
GLO-10	69	GM -DP	178	HAF-2	70	HOND-10P	183	HU -DFP	188
GLO-11	69	GM -E	178	HAF-2D	70	HOND-11	183	HU -DFP1	188
GLO-12D	69	GM -EP	178	HAF-3D	70	HOND-11P	183	HU -DHP	188
GLO-22	69	GM -H	178	HAF-4	70	HOND-12	183	HU -DNP	188
GLO-22D	69	GM -HP	178	HAG-1D	70	HOND-12P	183	HU -HAAC1	188
GLO-23	69	GM -J	178	HAK-1D	71	HOND-13	183	HU -HAAC2	189
GLO-23D	69	GM -JP	178	HAK-2D	71	HOND-13P	183	HU -HAAC3	236
GM - 1P	175	GM -K	178	HAK-3	71	HOND-14	183	HU -HAAC4	236
GM - 2	175	GM -KP	178	HAK-4	71	HOND-14P	183	HU -HAAC5	189
GM - 2P	175	GMG-1G	310	HAK-5	71	HOND-15	183	HU -HAAP1	189
GM - 3P	175	GMG-2G	310	HAL-1	70	HOND-15P	184	HU -MN	189
GM - 4	175	GMT-1	65	HAR-1I	71	HOND-16D	184	HU -MNP	189
GM - 4P	176	GMT-2	65			HOND-16DP	184	HU -NAAC2	189



REF.	PAG.
HU-NW	189
HU-P	189
HU-SC	189
HU-SR	189
HU-SU	189
HU-SX	189
HU-SY	189
HU-SZ	189
HUD-1	185
HUD-1D	185
HUD-2D	72-185
HUD-3	72
HUN-1D	72
HUW-1	72-196
HUW-1D	72-196
HUW-2	72
HUW-3D	72
HUW-N	73-196
HY-1	196
HY-2	196
HY-2P	196
HY-3	196
HY-3D	196
HY-3DP	196
HY-3DP1	196
HY-3DP2	196
HY-3P2	196
HY-3P3	196
HY-4	197
HY-4P	197
HY-4P2	197
HY-4P3	197
HY-5	197
HY-5P	197
HY-6D	197
HY-6DP	197
HY-7P	197
HY-8	197
HY-8P	197
HY-9P2	197
HY-11DP1	198
HY-11DP3	198
HY-11P3	198
HY-12P3	198
<b>I</b>	
I-1G	344
I-1G NIQ	344
IB-1	73
IB-2	73
ICA-1	73
ICA-4IP	73
ICA-5IP	73
ICS-1D	73
ICS-2D	73
IDM-1G	311
IDM-2G	311
IDM-3G	311
IDM-4G	311
IDM-5G	311

REF.	PAG.
IF-11	73
IF-2	73
IF-3P	73
IF-4	73
IF-5	73
IF-6	74
IF-15	74
IF-35	74
IF-45-55	74
IF-60-70	74
IF-D20	74
IF-D25	74
IF-D30	74
IF-I20	74
IF-I25	74
IF-I30	74
IF-I40	74
IF-I40L	74
IF-I50	74
IF-I51	74
IF-I60-70	74
IGS-1	74
IL-1D	77
IL-11	77
IL-2	77
ILC-1D	77
ILC-2D	77
ILC-3	77
ILC-6D	77
ILL-1	77
ILL-2	77
ILL-2D	77
ILS-1	77
IMB-1	77
IMB-1D	77
IMS-3	224
IMS-3C	198
IMS-3P	224
IMS-5	224
IMS-5C	198
IMS-5P	224
IMS-6D	198
IMS-6I	198
IMS-7	198
IMS-7P	198
IMS-8	198
IMS-9	198
IMS-10	198
IMS-11P	198
IMS-12	198
IMS-13	224
IMS-13P	224
IMS-MER	199
IN-1	234
IN-4	234
IN-5	234
INCE-1E	78
INCE-2E	78
ING-6	78
ING-A	78

REF.	PAG.
ING-D	78
ING-M	78
ING-N	78
ING-S	78
ING-W	78
INT-1	78
INT-1D	78
IR-1P	78
IS-1D	78
IS-1G	311
IS-11	78
IS-1X	249
IS-2D	78
IS-2G	311
IS-2I	78
IS-3D	78
IS-3G	311
IS-3I	78
IS-4	78
IS-4G	312
IS-5D	78
IS-5G	312
IS-6D	78
IS-6G	312
IS-7D	78
IS-8	78
IS-8D	78
IS-10	79
IS-10P	79
IS-14D	79
IS-15	79
IS-16D	79
IS-17D	79
IS-18D	78
IS-19D	78
IS-20	79
ISU-1	199
ISU-2	199
ISU-3D	199
ISU-3DP	199
IT-1G	312
IT-1TG	312
IT-2G	312
IT-3G	312
IT-4G	312
ITO-1D	79
ITO-2D	79
IV-1	79
IV-2D	79
<b>J</b>	
J-1G(CV)	344
J-2G(CV)	344
J-3G	344
J-3G(CV)	344
JAR-1D	79
JAR-1I	79
JAR-2D	79
JAR-2I	79
JAR-3	79

REF.	PAG.
JAR-4D	80
JAR-5D	80
JAR-5I	80
JAR-6	79
JAR-6D	79
JAU-1P	229
JD-1	199
JD-2	199
JD-3D	199
JD-4D	199
JGH-1D	82
JIN-1D	80
JIP-1D	80
JIP-1I	80
JIS-1D	80
JIS-2I	80
JIS-3D	80
JIS-3I	80
JIS-4P	80
JMA-1D	146
JMA-1I	146
JMA-2D	146
JMA-2I	146
JMA-3D	146
JMA-3I	146
JMA-4D	146
JMA-4I	146
JMA-9D	146
JMA-9I	146
JNG-1	82
JNG-1D	82
JNG-2D	82
JNG-3	82
JO-1	80
JOM-1D	80
JPM-1D	81
JPM-1E	81
JPM-1I	81
JPM-2D	81
JPM-2E	81
JPM-2I	81
JPM-3D	81
JPM-4	81
JPM-4D	81
JPM-10D	81
JPM-11D	81
JTF-1I	81
JTF-2I	81
JTF-3	81
JTF-4	81
JU-1	82
JU-2	82
JU-2D	82
JUNI-1	82
JUNI-1D	82
JUNI-2	82
JUNI-2D	82
JUNI-3D	82
JUNI-4D	82
JUNI-5D	82

REF.	PAG.
JUNI-6D	82
JUNI-7D	82
JUNI-8D	82
JUNI-9D	82
JUZU-1	82
JV-1D	82
JV-1I	82
JV-2	82
JV-3D	82
JV-3I	82
JV-4I	82
JV-5I	82
JV-6	82
JV-7	82
JV-7D	82
JW-20G	313
JW-30G	313
JW-40G	313
JW-45G	313
JW-50G	313
JW-70G	313
JW-90G	313
JWL-1D	80
JWL-2D	80
JWL-3D	80
JWL-4D	80
JWL-5	81
JWL-6	81
JWL-7D	81
JWL-9	80
JWL-9D	80
JWL-10D	81
JWL-11D	81
<b>K</b>	
KA-1	82
KA-2	82
KA-3	82
KA-4	82
KA-5	83
KA-6	83
KA-7	82
KA-8	83
KA-10	83
KA-11	83
KAB-1D	83
KAE-1	83
KAE-1G	313
KAE-2	83
KAE-3	83
KAE-3D	83
KAE-4	83
KAE-5	83
KAE-6	83
KAE-6D	83
KAE-7	83
KAE-7D	83
KAE-8	84
KAE-8D	84
KAE-9	84

# ÍNDICE GENERAL

## GENERAL INDEX

REF.	PAG.	REF.	PAG.	REF.	PAG.	REF.	PAG.	REF.	PAG.
KAE-9D	84	KI-2D	201	LAP-3D	87	LAS-TK	88-202	LF-24	94
KAE-10D	84	KI-3DP	201	LAP-3E	87	LAS-TX	89-202	LF-25	94
KAE-11D	84	KI-3P	201	LAP-3I	87	LAS-U	88-202	LF-26	94
KAE-12D	84	KIC-1	85	LAP-4	87	LAS-V	89-202	LF-27	94
KAE-13D	84	KIF-1	85	LAP-5D	87	LAS-X	88-202	LF-28	94-204
KAE-14	84	KIF-1D	85	LAP-6	87	LAS-XS	89-202	LF-29D	94
KAL-1	84	KIF-2D	85	LAP-7D	87	LAS-XY	89-202	LF-30	94
KAL-2D	84	KIR-1D	86	LAP-8D	87	LAS-Y	89-202	LF-31	95
KAM-1	199	KIR-2	86	LAP-9	87	LASB-1	89	LF-32	93-203
KAM-1D	199	KNA-1D	86	LAP-9D	87	LASB-1D	89	LF-33D	94
KAP-1D	84	KOM-1	201	LAP-10D	87	LASB-1G	288	LF-34	95
KAP-2D	84	KP-1	86	LAP-11D	87	LASB-2	89	LF-35	95
KAS-1G	314	KR-1X	250	LAP-13P	87	LASB-2D	89	LF-36	95
KAS-2G	314	KR-2X	250	LAP-17P	87	LASB-2G	288	LF-37D	95
KAS-4G	314	KR-3X	250	LAP-20P	87	LASB-3D	89	LF-38D	95
KAS-6G	314	KR-4X	250	LAP-21P	87	LASB-3G	288	LF-39D	204
KAW-1D	199	KR-5X	250	LAP-22P	87	LASB-4G	288	LF-40	94
KAW-1I	199	KR-6X	250	LAP-23P	87	LB-1	91	LF-41	95
KAW-2D	199	KR-7X	250	LAP-28D	87	LB-1D	91	LF-43	94
KAW-2I	199	KR-8X	250	LAP-29D	87	LB-2D	92	LF-44	95
KAW-3	199	KR-9X	251	LAP-30D	87	LB-2DP	92	LF-45	95
KAW-4	200	KR-10X	251	LAP-34D	87	LB-3	92	LF-46	95
KAW-5	200	KR-11X	251	LAP-42D	88	LB-3D	92	LF-BL	204
KAW-5P	200	KR-12X	251	LAP-43D	88	LB-4D	92	LF-RO	204
KAW-6DP	200	KR-13X	251	LAP-44D	88	LCK-1X	252	LF-ROP	204
KAW-6P	200	KR-14X	251	LAP-45D	88	LEA-1D	89	LF-SL	204
KAW-7P	200	KR-15X	251	LAP-46D	88	LEA-2D	89	LF-SLP	204
KAW-8	200	KR-16X	251	LAP-88	88	LEG-1D	89	LF-WB	204
KAW-8D	200	KR-17X	252	LAP-96D	88	LF-1D	92-203	LF-WBP	205
KAW-9P	200	KRA-1D	86	LAR-1G	288	LF-1I	92-203	LF-WR	205
KAW-10P	200	KRA-2	86	LAR-1I	88	LF-2	93-203	LIN-1D	89
KAZ-1	84	KRE-1D	86	LAR-2G	332	LF-3	203	LIN-1I	89
KAZ-2	84	KRP-1G	315	LAR-3G	332	LF-4I	93-203	LIN-2	89
KAZ-3	84	KUR-1G	315	LAS-1D	88-202	LF-5	93-203	LIN-2G	315
KAZ-4	84	KWI-1	86	LAS-2	88-202	LF-5D	93-203	LIN-3D	89
KAZ-5	84	KWI-2D	86	LAS-3	88-202	LF-6	203	LIN-3G	315
KAZ-5D	84	KYM-1DP	201	LAS-4	88-202	LF-7	93-203	LIN-3I	89
KAZ-6	85	KYM-1P	201	LAS-4D	88-202	LF-7D	93-203	LIN-4D	89
KAZ-7	85	KYM-2	201	LAS-5	88-202	LF-8	93-204	LIN-4I	89
KE-1	85	KYM-2D	201	LAS-5D	88-202	LF-8D	93-204	LIN-5D	90
KE-3	85	KYM-2DP	201	LAS-6	88-202	LF-9	204	LIN-5I	90
KE-4	85	KYM-2P	201	LAS-6D	88-202	LF-10	93	LIN-6D	90
KE-5	85	KYM-3P	201	LAS-7	88	LF-11	93-204	LIN-6I	90
KEN-1	200	KYM-3DP	201	LAS-8	88	LF-11D	93-204	LIN-7D	90
KEN-1D	200			LAS-9	88	LF-12	93-203	LIN-7I	90
KFV-1	85	<b>L</b>		LAS-10	89	LF-12D	93-203	LIN-8D	90
KFV-1X	249	L-3G	344	LAS-11	89	LF-13	93	LIN-8I	90
KFV-2X	249	L-3G(CV)	344	LAS-11D	89	LF-13D	93	LIN-9	90
KFV-3X	249	LA-1D	201	LAS-12D	89	LF-14D	93	LIN-10D	90
KFV-C	85	LA-1DP	201	LAS-AX	88-202	LF-15	93-204	LIN-10I	90
KFV-D	85	LA-2	201	LAS-AX-L	89	LF-15D	93-204	LIN-11D	90
KFV-E	85	LA-2P	201	LAS-BT	202	LF-16	93	LIN-11I	90
KFV-F	85	LA-3D	201	LAS-CR	202	LF-17	93-204	LIN-12D	90
KFV-L	85	LA-3DP	201	LAS-FH	88-202	LF-18D	93	LIN-12I	90
KFV-M	85	LA-4D	202	LAS-KT	88-202	LF-19	94	LIN-13	90
KFV-N	85	LA-4DP	202	LAS-P	202	LF-20	94	LIN-14D	89
KFV-O	85	LAF-1D	86	LAS-R	89-202	LF-20D	94	LIN-14I	89
KI-1D	200	LAP-1	86	LAS-RC	202	LF-21	94	LIN-15D	89
KI-1DP	200	LAP-2D	86	LAS-SX	89-202	LF-22	94	LIN-15I	89
KI-1DP1	200	LAP-2E	86	LAS-TB	202	LF-23	94	LIN-16	90

REF.	PAG.	REF.	PAG.	REF.	PAG.	REF.	PAG.	REF.	PAG.
LIN-16D	90	LWO- 2	92	MAZ- 6DP	206	MCM-32D	99	MER-13I	100
LIN-17	90	LWO- 2D	92	MAZ- 6P	206	MCM-33	99	MER-14I	100
LIN-17D	90	LWO- 7D	92	MAZ- 7D	206	MCM-35	99	MER-15	100
LIN-18	90	LWO- 8	92	MAZ- 7DP	206	ME - 1	189	MER-16	100
LIN-18D	90	LWO- 9	92	MAZ- 7DP1	206	ME - 1P	189	MER-16D	100
LIN-19D	90	LWO-26D	92	MAZ- 8D	206	ME - 2P	190	MER-17	100
LIN-20D	89	LYF-1T	96	MAZ- 8DP	206	ME - 3P	190	MER-18	100
LIN-21D	90	LYF-2T	96	MAZ-11D	206	ME - 4P	190	MER-19D	101
LIN-25	90			MAZ-11DP1	206	ME - 5P	190	MER-20D	101
LIN-25D	90	<b>M</b>		MAZ-13D	206	ME - 6P	190	MER-21D	101
LIP- 1D	90	MA-5D	96	MAZ-13DP	206	ME - 7P	190	MERI-1D	207
LIP- 1GD	91	MAC-1G	336	MAZ-13DP1	207	ME - 8P	190	MERI-1DP	207
LIP- 1I	90	MAG-2DP	96	MAZ-14D	207	ME - 9P	190	MET-2D	101
LIP- 2	91	MAK-1	205	MAZ-15D	207	ME -10P	190	MEZ-1D	101
LIP- 2D	91	MAR-1P	205	MAZ-16	207	ME -11P	190	MG-6D	40
LIP- 3	91	MAS - 1	96	MAZ-21DP1	207	ME -12P	190	MG-6I	40
LIP- 4	91	MAS - 1D	96	MBL-1	103	ME -13DP	190	MG-6S	40
LIP-28D	91	MAS - 2D	96	MBL-1D	103	ME -14P	190	MG-9	40
LIP-33	91	MAS - 3D	96	MCH-1	101	ME -HD	191	MGA-1	101
LIT-1I	91	MAS - 4D	96	MCH-1D	101	ME -HDP	191	MGA-1D	101
LIT-2D	91	MAS - 5D	96	MCH-2	101	ME -HF	191	MGA-2	101
LIT-2GD	91	MAS - 6	96	MCH-2D	101	ME -HFP	191	MGA-3	101
LIT-3D	91	MAS - 7	96	MCL-1D	97	ME -HM	191	MI-1D	101
LIT-5D	91	MAS - 7D	96	MCM- 1	97	ME -HMLP	191	MI-2D	101
LIT-5I	91	MAS - 8	96	MCM- 1G	288	ME -HMP	191	MI-3D	102
LIT-7D	91	MAS - 9	97	MCM- 2D	97	ME -HU	191	MI-4D	102
LMP-1	202	MAS - 9D	97	MCM- 2G	315	ME -HUP	191	MI-5D	102
LMP-1P	202	MAS -10	97	MCM- 2I	97	ME -HY	191	MIL-1	102
LMP-2	203	MAS -10D	97	MCM- 3D	98	ME -HYP	191	MIL-2	102
LMP-2P	203	MAS -11	96	MCM- 3G	315	ME -HZ	191	MIN-1D	102
LMP-3	203	MAS -11D	96	MCM- 3I	98	ME -HZP	191	MIS-1	207
LMP-3P	203	MAS -12D	96	MCM- 4D	98	ME -L	191	MIT- 1D	207
LMP-4	203	MAS -13D	97	MCM- 4EC	98	ME -NU	191	MIT- 1DP	207
LMP-4P	203	MAS -15P	97	MCM- 4G	289	ME -NUP	191	MIT- 1I	207
LMP-4P1	203	MAS -17	97	MCM- 4I	98	ME -NY	191	MIT- 1IP	207
LMP-5	203	MAS -17D	97	MCM- 4SS	98	ME -NYP	191	MIT- 2D	207
LMP-5P	203	MAS -18D	97	MCM- 5D	98	ME -S	191	MIT- 2DP	207
LMP-5P1	203	MAS -19	97	MCM- 5G	315	ME -SP	192	MIT- 2I	207
LO-1D	92	MAS -22D	96	MCM- 5I	98	ME -VA	192	MIT- 2IP	207
LO-1I	92	MAS -24D	96	MCM- 6	98	MEC-5D	99	MIT- 3	208
LO-2D	92	MAS -29D	97	MCM- 7	98	MEL-1	99	MIT- 3P	208
LO-2I	92	MASL-1	97	MCM- 8	98	MEL-2D	100	MIT- 4	208
LO-3D	92	MAX-1G	336	MCM-10	98	MEL-3	100	MIT- 4P	208
LO-4D	92	MAX-2G	336	MCM-11S	98	MEL-4	99	MIT- 5	208
LOC-1D	92	MAZ- 1D	205	MCM-12D	98	MEL-4D	99	MIT- 5P	208
LPO- 1	88	MAZ- 1I	205	MCM-13D	98	MEL-5P	100	MIT- 6	208
LPO- 2	88	MAZ- 2D	205	MCM-16	98	MER- 1D	100	MIT- 6P	208
LT-1	95	MAZ- 2DP	205	MCM-18D	98	MER- 1T	100	MIT- 7	208
LUC-1D	95	MAZ- 2I	205	MCM-21D	98	MER- 2I	100	MIT- 7P	208
LUC-2	95	MAZ- 2IP	205	MCM-24B	99	MER- 3I	100	MIT- 8D	208
LUMA-1D	95	MAZ- 3D	205	MCM-24C	99	MER- 3T	100	MIT- 8DP	208
LUMA-1I	95	MAZ- 3DP	205	MCM-24D	99	MER- 4I	100	MIT- 9	209
LUMA-2D	95	MAZ- 3I	205	MCM-24E	99	MER- 5I	100	MIT-10	209
LUMA-2I	95	MAZ- 3IP	205	MCM-24F	99	MER- 6I	100	MIT-11D	209
LUMA-3D	95	MAZ- 4	205	MCM-26	99	MER- 7I	100	MIT-12	209
LUMA-3I	95	MAZ- 4P	205	MCM-27	99	MER- 8I	100	MIT-13D	209
LUMA-4D	95	MAZ- 5D	205	MCM-29D	99	MER- 9I	100	MIT-14D	209
LUMA-4I	95	MAZ- 5DP	206	MCM-30D	99	MER-10I	100	MIT-15P	208
LWO- 1	92	MAZ- 6	206	MCM-31	99	MER-11I	100	MIW-1	102
LWO- 1D	92	MAZ- 6D	206	MCM-31D	99	MER-12I	100	MIW-2	102

# ÍNDICE GENERAL

## GENERAL INDEX

REF.	PAG.	REF.	PAG.	REF.	PAG.	REF.	PAG.	REF.	PAG.
MIW-3	102	MT-14G	319	NE-10	211	NE-39P	215	OJ- 9D	106
MIW-4	102	MT-15G	319	NE-10P	211	NE-40	215	OJ-10	106
MLM-1D	102	MT-16G	319	NE-11	211	NE-40P	215	OJ-11	106
MLM-2	102	MT-17PG	319	NE-11P	211	NE-41P	216	OJ-12	106
MLM-3	103	MT-18G	319	NE-11P1	211	NE-42	216	OJ-13	106
MLM-4	103	MT-AG	104	NE-11P2	211	NE-42P	216	OJ-14	106
MLM-5	102	MT-AGP	104	NE-11P3	212	NE-42P1	216	OJ-15	106
MLM-5D	102	MT-CG	104	NE-12	212	NE-43	216	OJ-16	106
MLM-6	103	MT-CGP	104	NE-12P	212	NE-44P	214	OJ-17	106
MLM-7	103	MT-DGP	104	NE-13	212	NE-45	216	OJ-18P	106
MM-1X	252	MT-EG	104	NE-14	212	NE-45P	216	OJ-19	106
MNO-1D	103	MT-EGP	104	NE-15D	210	NE-46	216	OJ-J	106
MOD-1DP	209	MT-GG	104	NE-15DP	210	NE-47	216	OJ-K	106
MOG-1D	103	MT-GGP	104	NE-15DP1	210	NE-48	216	OJ-L	106
MOI-1G	316	MTL-1	101	NE-15I	210	NE-49	216	OJ-M	106
MOI-2G	316	MTL-1D	101	NE-15IP	210	NE-50P	216	OJ-Q	106
MOI-3G	316	MTL-1G	315	NE-15IP1	210	NE-51P2	217	OL-5D	106
MOK-1G	289	MTL-2G	316	NE-16	212	NE-52P	217	OLIV-1	107
MON-1D	103	MTO-1	101	NE-18	212	NE-53	217	OM-1	107
MON-1I	103	MUL-T 2P	104	NE-18P	212	NE-54P	217	OMC-1D	107
MON-2D	103	MUL-T 3P	104	NE-19	212	NE-55P	217	OMC-1G	319
MON-2I	103	MUL-T 3P1	104	NE-19P	212	NE-56	217	OMC-2D	107
MOR-1X	252	MUL-T 4P	104	NE-19P1	212	NE-57	217	OMC-3	107
MOR-2X	252	MUL-T 5P	104	NE-20	212	NE-58D	217	OMC-4	107
MOS-1	209	MUL-T 6	105	NE-20P	212	NE-59P	217	OMC-5D	107
MP-1D	104	MUL-T 6D	105	NE-20P1	212	NE-60C1	217	OMC-6D	107
MP-1I	104	MUL-T 7P	104	NE-20P2	213	NE-60C2	217	OMI-1	107
MPA-1G	289	MUL-T 8P1	104	NE-20P3	213	NE-61D	218	OMI-1D	107
MQ-1D	96	MUL-T 9P1	104	NE-22P	213	NE-62	218	ON-1D	107
MQ-1I	96	MUL-T10P	105	NE-22P1	213	NE-63D	218	ON-1I	107
MR-1	103	MUL-T11P1	104	NE-22P2	213	NEF-1X	253	OP- 1	192
MR-2	103	MUL-T16P	105	NE-23	213	NEF-2Z 1	340	OP- 6	192
MR-3	103	MXS-1	97	NE-24	213	NEF-2Z 2	340	OP- 7	192
MSM-1D	104			NE-24P	213	NEF-2Z 3	340	OP- 8	192
MSM-2D	104			NE-24P1	213	NEF-2Z 4	340	OP- 9	192
MSV-1	104	<b>N</b>		NE-25	213	NEF-2Z 5	340	OP-11C1	192
MSV-1X	252	N-1G	345	NE-26	213	NEF-2Z 6	340	OP-AB	192
MSV-2	104	N-1G NIQ	345	NE-27	213	NEF-2Z 7	340	OP-ABP	192
MT- 1G	316	NAB-1X	252	NE-28	213	NEF-2Z 8	340	OP-BA	192
MT- 2G	316	NE- 1	209	NE-28	213	NEF-2Z 9	340	OP-BAP	192
MT- 2TG	316	NE- 1D	209	NE-29	214	NEF-2Z10	340	OP-BB	192
MT- 3G	316	NE- 1DP	209	NE-29P	214	NO-1	105	OP-CC	192
MT- 3P1G	317	NE- 1P	209	NE-30	214	NTC-10D	105	OP-D	192
MT- 3PG	317	NE- 2	209	NE-30P	214	NTC-6	105	OP-DD	192
MT- 4G	317	NE- 3	210	NE-31	214			OP-DP	192
MT- 5G	317	NE- 3D	210	NE-31P	214			OP-EE	192
MT- 5P1G	317	NE- 3P	210	NE-32	214	<b>O</b>		OP-FF	192
MT- 6G	317	NE- 3P1	210	NE-32P	214	OA-1	107	OP-HA	193
MT- 6P1G	318	NE- 3P2	210	NE-33P	214	OCA-1D	105	OP-HB	193
MT- 6PG	318	NE- 4	210	NE-33P1	214	OCA-2D	105	OP-HG	193
MT- 8G	318	NE- 4D	210	NE-34P	214	OF-1	105	OP-HH	193
MT- 8P1G	318	NE- 4P	210	NE-35	214	OF-2	105	OP-J	193
MT- 8PG	318	NE- 4P1	210	NE-35P	215	OJ- 1D	105	OP-JP	193
MT- 9G	318	NE- 4P2	210	NE-35P2	215	OJ- 2I	105	OP-NA	193
MT- 9P1G	318	NE- 5	210	NE-36	215	OJ- 3D	105	OP-NB	193
MT- 9PG	318	NE- 6	211	NE-36P	215	OJ- 3I	105	OP-R	193
MT-10G	317	NE- 6P	211	NE-36P1	215	OJ- 4D	106	OP-RP	193
MT-10P1G	318	NE- 7	211	NE-37	215	OJ- 5I	106	OP-S	192
MT-10PG	318	NE- 8	211	NE-37P	215	OJ- 6D	106	OP-SP	192
MT-11G	318	NE- 9	211	NE-38	215	OJ- 6I	106	OP-SP1	193
		NE- 9P	211	NE-38P1	215	OJ- 7I	105		



REF.	PAG.
OP-T	193
OP-TP	193
OP-WHC1	193
OP-WHP	193
OP-WYP	193
OR-0G	333
OR-1G	333
OR-1I	107
OR-2G	319
OR-3G	289
OR-4G	333
OR-5G	333
OR-6G	289
ORK-1D	108
ORO-1D	108
OST-1G	289
OST-2G	289

## P

PAD-1D	108
PAD-2D	108
PAD-3	108
PAD-3D	108
PAP-1	108
PAP-1X	253
PAP-2	108
PAP-2X	253
PAP-3	108
PAP-4	108
PAP-5	108
PAP-6	108
PAT-1G	319
PC-1D	109
PC-1T	109
PC-2D	109
PC-3TP	109
PCI-1T	108
PEN-1	109
PEN-1D	109
PEN-2	109
PET-1	109
PEU-1C1	236
PEU-2C1	236
PFA- 1	109
PFA- 2	109
PFA- 3	109
PFA- 4	109
PFA- 5	109
PFA- 6	110
PFA- 6D	110
PFA- 7D	110
PFA- 8D	110
PFA- 9D	110
PFA-10D	109
PFA-11D	109
PFA-12D	109
PFA-13D	109
PFA-14D	109
PFA-15D	109
PFA-16D	109

REF.	PAG.
PFA-17D	109
PFA-18D	109
PFA-21	110
PFA-22	109
PFA-22D	109
PGO-1	221
PGO-2P	221
PHI-52	110
PHO-1	110
PIC-1E	110
PIC-8D	110
PJ-1	221
PJ-2	221
PJ-2P	221
PJ-3	221
PJ-K	221
PJ-KP	222
PLL-1	222
PO -1P	193
PO -2P	194
PO -HC	194
PO -HCP	194
PO -NC	194
PO -NCP	194
POL-3TEC	110
POL-4E	110
POL-5TEC	110
POS-1DP	222
PPT-1G	289
PPT-2G	289
PPT-3G	289
PR- 1	110
PR- 1D	110
PR- 1G	321
PR- 2	110
PR- 2G	336
PR- 3	110
PR- 3G	321
PR- 4D	110
PR- 4G	321
PR- 4I	110
PR- 5D	111
PR- 5I	111
PR- 6	111
PR- 7	111
PR- 8	111
PR- 9	111
PR- 9D	111
PR-10	110
PR-11	110
PR-12	111
PR-13	111
PR-14	111
PR-15D	111
PR-16	111
PR-16D	111
PR-17D	111
PR-18	111
PR-19	111
PR-20	111

REF.	PAG.
PR-20D	111
PRE-1I	222
PRE-2I	222
PRE-3	222
PTN- 1D	110
PTN- 1G	320
PTN- 2D	110
PTN- 2G	320
PTN- 3G	320
PTN- 4G	320
PTN- 5G	320
PTN- 6G	320
PTN- 7G	320
PTN-10G	320
PTN-11G	321
PTN-13G	321
PTN-13TG	321
PTN-14G	321
PTN-15G	321

## R

RAZ-1D	112
RE-1	111
RE-1D	111
RE-2	111
RE-2D	111
RE-3D	112
RE-4D	111
RE-5D	112
REG-1D	111
REN-1G	290
REN-2G	290
REVI-1G	321
REX-1D	112
REX-1G	290
REX-2G	290
RGL-1G	322
RGM -1D	112
RGM -1I	112
RGM -2	112
RI-1D	112
RI-1I	112
RI-2D	112
RI-2I	112
RI-3D	112
RI-3I	112
RIG-1D	112
RIO-1D	112
RIT-1D	112
RO- 1D	113-222
RO- 1DS	222
RO- 1I	113-222
RO- 1IS	222
RO- 1X	252
RO- 2D	113-222
RO- 2I	113-222
RO- 3	222
RO- 4D	113-222
RO- 4I	113-222
RO- 5D	113-222

REF.	PAG.
RO- 5I	113-222
RO- 6D	113-222
RO- 6I	113-222
RO- 7D	113-222
RO- 7I	113-222
RO- 8D	113-222
RO- 8I	113-222
RO- 9D	113
RO- 9I	113
RO-10D	113
RO-10I	113
RO-11D	113-222
RO-11I	113-222
RO-12D	114-223
RO-12I	114-223
RO-14	223
RO-15	223
RO-16D	114-223
RO-16I	114-223
RO-17	223
RO-18I	113
RO-19D	113
RO-19I	113
RO-20D	113
RO-20I	113
RO-21D	113
RO-21I	113
RO-22I	113
RO-23D	113
RO-24D	114
RO-24I	114
RO-25D	114
RO-25I	114
RO-26D	114
RO-26I	114
RO-27D	114
RO-27I	114
RO-28D	114
RO-28I	114
RO-29D	114
RO-30	113-222
RO-30D	113-222
RO-31D	114
RO-32D	113-222
RO-33	113-222
RO-34D	114
RO-36D	114
RO-37	114
RO-37D	114
RO-38	114
RO-38D	114
RO-39	114
RO-40	114
RO-40D	114
RO-41	114
RO-42	114
ROS-1D	223
ROS-2	223
ROSE -1	114
ROY-1	114

REF.	PAG.
RSS-1	115
RSS-2D	115
RST-1	25
RU - 1D	114
RU - 2D	114
RU - 2I	114
RU - 3D	114
RU - 4D	114
RU - 5D	115
RU - 5I	115
RU - 6I	115
RU - 7D	115
RU - 8D	115
RU - 9D	115
RU - 9I	115
RU -10D	114
RU -11D	115
RU -12D	115
RU -13D	115
RU -14D	115
RU -15	115
RU -16D	115
RU -19D	114
RU -GC	115
RU -GK	115
RU -GK7	115
RU -GL	115
RU -GL7	115
RU -GM	115
RU -GM7	115
RU -GS	115
RU -GS7	115
RU -K	115
RU -KD	115
RU -L	115
RU -M	115
RU -TL	114
RUB-1G	322
RUB-2G	322
RUB-3G	336
RUB-4G	322
RUB-5G	322
RUB-6G	333
RUB-7G	322
RUB-8G	322
RUB-9G	322
RUE-2G	333
RUS-1	115
RUS-2	115

## S

SA-1	116
SA-1D	116
SA-2	116
SA-3D	116
SA-3I	116
SA-4	116
SAA-1P	223
SAA-1P1	223
SAA-2P	223

# ÍNDICE GENERAL

## GENERAL INDEX

REF.	PAG.	REF.	PAG.	REF.	PAG.	REF.	PAG.	REF.	PAG.
SAA-AC	223	SI-1D	226	SLG-3	117	SR-4	125	STS-13D	124
SAA-ACP	223	SI-2D	226	SLG-4	117	SR-5	125	STS-21D	124
SABT-1	116	SI-3	226	SLG-5	117	SRM-1G	324	STS-28	123
SAF-1G	323	SI-3D	226	SLG-6	117	SSA-1P1	226	STS-35	124
SAF-2G	323	SI-4	226	SLG-7	117	SSO-1	120	STS-38	124
SAG-1T	135	SI-4D	226	SLG-8	117	SSO-2	120	STS-B1	124
SAM-1D	116	SI-5D	226	SLG-9	117	ST-1I	122	STS-T14	124
SAM-1G	323	SIA-2G	324	SLG-10	117	ST-2	122	STS-TV 3	124
SAM-2D	116	SIA-3G	324	SLG-11	117	STA-1	122	STS-TV 5	124
SAM-2G	323	SIB-1G	337	SLG-12	117	STA-1D	122	STS-TV 8	124
SAM-4G	323	SIB-2G	324	SLG-13	117	STA-2	122	STS-TV 9	124
SAM-5G	323	SIB-3G	325	SLG-14	117	STA-2D	122	STS-X5	124
SAR-1	116	SIB-4G	325	SLG-15	117	STA-3	122	STS-X6	124
SAR-1D	116	SIB-5G	325	SLG-16	117	STA-3D	122	STUV-1D	124
SAR-2D	116	SID-1	119	SLG-17	117	STA-4	122	STUV-1I	124
SAR-3D	116	SID-2	119	SLG-18	117	STA-4D	122	STUV-2	125
SAR-4	116	SIM-900	167	SLG-19	117	STA-5	122	STUV-3	124
SAR-4D	116	SIM-1200	160	SLG-20	117	STA-5D	122	SUB-2P	227
SAR-5D	116	SIP-1	226	SLG-21	117	STB-1	124	SUZU-1D	227
SAR-6	116	SIP-2	226	SLG-22	117	STB-1D	124	SUZU-1I	227
SAR-6D	116	SIP-3	226	SLG-23	117	STE-1	123	SUZU-2D	227
SAT-1D	117	SIS-1	119	SLG-24	117	STE-2D	123	SUZU-2I	227
SAT-2	117	SIS-2	119	SLG-25	117	STE-3	123	SUZU-3I	227
SB-1PG	323	SIS-3	119	SM-1	119	STE-4	123	SUZU-4D	227
SCC-1D	117	SIS-4D	119	SM-2	119	STE-5D	123	SUZU-4DP	227
SCH-1D	117	SIS-5D	119	SM-3	119	STE-6	123	SUZU-4I	227
SCO-1	18	SIS-6	119	SM-3D	119	STE-7	123	SUZU-4IP	227
SCR-1	118	SIS-6D	119	SM-4	119	STE-8D	123	SUZU-5	227
SDR-1G	325	SIS-7D	119	SM-4D	119	STE-9D	123	SUZU-5P	228
SDR-2G	325	SIS-8	120	SOF-1	120	STE-10	123	SUZU-6	228
SDR-3G	325	SIS-8D	120	SOF-2	120	STE-11	123	SUZU-7	228
SE-AHP	194	SIS-9	120	SOFI-1D	120	STE-12	123	SUZU-7DP	228
SE-AN	194	SIS-9D	120	SOFI-1I	120	STE-13D	123	SUZU-7P	228
SEA-1	117	SIX-1	225	SOFI-2D	120	STE-14D	123	SUZU-8	228
SEA-2	118	SIX-1P	225	SOFI-2I	120	STF-1	124	SUZU-8I	228
SEC-1	118	SIX-1P1	225	SOFI-3I	120	STF-1D	124	SUZU-8P	228
SEC-1G	323	SIX-1P2	225	SOFI-4	120	STG-1	123	SUZU-9P	228
SEC-2	118	SIX-2	225	SOFI-4D	120	STK-1	122	SUZU-10	228
SEC-2G	324	SIX-2P	225	SOFI-5	120	STL-1D	122	SUZU-10P	228
SEC-3	118	SIX-2P2	225	SOFI-6	120	STL-2I	122	SUZU-11D	228
SEC-3G	324	SIX-3P	225	SOL-1	120	STR-1	123	SUZU-11DP	228
SEC-4G	324	SIX-3P1	225	SOP-1D	120	STR-2	123	SUZU-12DP	228
SEC-7G	324	SIX-3P2	225	SOS-1D	121	STR-3	227	SUZU-13DP	229
SEL-1D	118	SIX-4	225	SOS-2D	121	STR-4	123-227	SUZU-13P	229
SEL-1I	118	SIX-4P	225	SOS-3	121	STR-5	123	SUZU-14P2	229
SEL-2D	118	SIX-5P	226	SOS-4D	121	STS-1D	123		
SEL-2I	118	SJL-1	120	SOS-5	121	STS-1DP	123	<b>T</b>	
SEL-3D	118	SKO-1	170	SPI-1	121	STS-1I	123	TAI-1	125
SEL-4D	118	SKO-1P	170	SPI-1D	121	STS-2D	227	TAL-1	125
SEN-1D	118	SKO-2	170	SQ-1	121	STS-2DP	227	TAL-1D	125
SEN-2D	118	SKO-3I	170	SQ-2	121	STS-3D	123	TAL-2	125
SER-1G	337	SKO-3IP	170	SQ-3D	121	STS-3I	123	TAL-3	125
SER-3D	118	SKO-4	170	SQ-4	121	STS-4D	123	TAP-1P	229
SH-1I	119	SKO-5P	171	SQ-5D	121	STS-4DP	123	TAP-2	229
SHA-1	119	SKO-6	171	SQ-6	121	STS-5D	227	TAT-1D	229
SHI-1	119	SKO-7	171	SQ-7	122	STS-5DP	227	TAT-1DP	229
SHI-1D	119	SKO-8	171	SQ-8D	122	STS-6D	123	TAT-2D	229
SHI-2D	119	SL-1	118	SR-1I	125	STS-7D	124	TAT-2DP	229
SHI-3D	119	SLG-1	117	SR-2	125	STS-11	227	TAY-1	126
SHR-1	117	SLG-2	117	SR-3	125	STS-12D	124	TC-1	126

REF.	PAG.	REF.	PAG.	REF.	PAG.	REF.	PAG.	REF.	PAG.
TC-2	126	TIT-12D	129	TOK-45	131	TOYO- 8	231	TRI- 8I	133
TE - 1D	126	TIT-13	129	TOK-45D	131	TOYO- 8IP	231	TRI- 9D	133
TE - 1G	290	TIT-15	129	TOK-46	131	TOYO- 8P	231	TRI- 9I	133
TE - 1I	126	TIT-15D	129	TOK-46D	131	TOYO- 9	231	TRI-10D	133
TE - 2G	290	TIT-16D	129	TOK-47	131	TOYO- 9P	231	TRI-10I	133
TE - 3	126	TIT-17	129	TOK-47D	131	TOYO- 9P1	231	TRI-11D	133
TE - 3G	290	TIT-18D	129	TOK-48	131	TOYO-10	231	TRI-11I	133
TE - 4	126	TIT-19D	128	TOK-48D	131	TOYO-10P	231	TRI-12D	133
TE - 7D	127	TK-2D	126	TOK-49	131	TOYO-10P1	231	TRI-12I	133
TE - 8D	127	TK-2I	126	TOK-50	131	TOYO-11	231	TRI-13	133
TE - 8DKT1	127	TKY-1	125	TOK-51	131	TOYO-11P	231	TRI-14	133
TE - 8I	127	TKY-2	125	TOK-52	131	TOYO-11P1	231	TRI-15	133
TE - 9D	127	TKY-3	125	TOK-53	131	TOYO-12	231	TRI-16	133
TE -10I	127	TOK- 2	130	TOK-54	131	TOYO-12D	231	TRI-17D	133
TE -11D	127	TOK- 2D	130	TOK-55	131	TOYO-12DP1	231	TRI-18	133
TE -23	127	TOK- 3	130	TOK-56D	131	TOYO-12P1	231	TRI-18D	133
TE -28	127	TOK- 3D	130	TOK-58	131	TOYO-13	231	TRI-19	133
TE -T10	127	TOK- 4D	130	TOK-59	131	TOYO-13P1	231	TRI-19D	133
TE -T10D	127	TOK- 5D	130	TOK-60	131	TOYO-14	230	TRI-20	133
TE -T11	127	TOK- 6	130	TOK-61	131	TOYO-14P	230	TRL-1P	132-233
TE -T12PLUS	127	TOK- 6D	130	TOK-62	131	TOYO-15	232	TRL-2	132
TE -T60	127	TOK- 7D	130	TOK-62D	131	TOYO-15P	232	TRM- 4	134
TE -T62	127	TOK- 8	131	TOK-63	131	TOYO-16	232	TRM-11D	134
TE -T80	127	TOK- 9	130	TOK-64	131	TOYO-16P	232	TRO-1	126
TE -T8OSC	127	TOK-10D	130	TOK-65	131	TOYO-16P1	232	TRO-1D	126
TE -T82	127	TOK-11	130	TOK-66	131	TOYO-17	232	TRP-1D	233
TEC-1G	325	TOK-12	130	TOK-67	131	TOYO-17P	232	TRU- 7	134
TEC-2	126	TOK-13D	130	TOK-68	131	TOYO-18P	232	TRU- 8P	135
TEI-1D	126	TOK-14D	130	TOK-69	131	TOYO-19P	232	TRV-1	132
TEM-D35	126	TOK-15	130	TOK-70	131	TOYO-20D	232	TRV-1D	132
TEM-D55	126	TOK-16D	130	TOK-71	131	TOYO-22	232	TSI-1G	325
TEM-I35	126	TOK-17D	130	TOK-71D	131	TOYO-22D	232	TST-1	134
TEM-I55	126	TOK-18	130	TOK-72	131	TOYO-23	233	TTN-1G	326
TEU-1	229	TOK-19	130	TOK-73	131	TOYO-23P	233	TTN-2G	326
TH-1	128	TOK-20	130	TOK-74	131	TOYO-24	233	TUF-1X	253
TI-1	128	TOK-21	131	TOK-75	131	TOYO-25	233	TUF-2X	253
TI-1D	128	TOK-21D	131	TOK-76	131	TOYO-26	233	TUF-3X	253
TIF- 1D	128	TOK-22	131	TOK-77	131	TOYO-27	233	TUL-1D	135
TIF- 2D	128	TOK-23	130	TOK-78	131	TOYO-28P	233	TUL-2D	135
TIF-15-20	128	TOK-24	131	TOM-1D	132	TOYO-29	233	TUS-1D	135
TIF-25D	128	TOK-25	130	TOO-1D	229	TOYO-30P1	233	TUS-1G	326
TIF-30D	128	TOK-26	130	TOO-2	230	TOYO-37D	233	TUS-2D	135
TIF-40D	128	TOK-27	130	TOP-1	132	TOYO-K1	230	TV- 1D	134
TIF-50-60	128	TOK-28D	130	TOV-1	132	TOYO-K1P	230	TV- 1G	290
TIG-1D	128	TOK-29D	130	TOV-1G	326	TR-1G	326	TV- 2D	134
TIT- 1D	128	TOK-30	130	TOV-2	132	TRI- 1D	133	TV- 2G	290
TIT- 2	128	TOK-31	130	TOV-3	132	TRI- 1I	133	TV- 3D	134
TIT- 2D	128	TOK-32	130	TOV-4	132	TRI- 2D	133	TV- 3G	291
TIT- 2GD	129	TOK-33	130	TOV-5	132	TRI- 2I	133	TV- 4D	134
TIT- 3	129	TOK-34D	130	TOV-6	132	TRI- 3D	133	TV- 5G	291
TIT- 4	129	TOK-37	131	TOV-7	132	TRI- 3I	133	TV- 7G	291
TIT- 5	129	TOK-38	131	TOYO- 2	230	TRI- 4D	133	TV- 8G	291
TIT- 6	129	TOK-39	131	TOYO- 3	230	TRI- 4I	133	TV- 9G	291
TIT- 7D	229	TOK-40	131	TOYO- 3P	230	TRI- 5D	133	TV-10G	291
TIT- 8D	129	TOK-41	131	TOYO- 4	230	TRI- 5I	133	TV-11	134
TIT- 8GD	129	TOK-41D	131	TOYO- 4P	230	TRI- 6D	133	TV-11G	291
TIT- 9	129	TOK-42	131	TOYO- 5	230	TRI- 6I	133	TV-12	134
TIT- 9D	129	TOK-43	131	TOYO- 5P	230	TRI- 7D	133	TV-12G	291
TIT-10	128	TOK-44	131	TOYO- 5P1	230	TRI- 7I	133	TV-13	134
TIT-11D	129	TOK-44D	131	TOYO- 6	230	TRI- 8D	133	TV-13G	291

# ÍNDICE GENERAL

## GENERAL INDEX

REF.	PAG.
TV-14G	291
TV-15D	134
TV-15G	291
TV-16D	134
TV-16G	291
TV-17	134
TV-17D	134
TV-17G	291
TV-18D	134
TV-18G	291
TV-19D	134
TV-19G	291
TV-20	134
TV-20G	291
TV-21	134
TV-21G	291
TV-22	134
TV-22D	134
TV-22G	292
TV-23	134
TV-23D	134
TV-23G	292
TV-24G	292
TV-25G	292
TV-26G	292
TV-27G	292
TV-30	134
TV-31	134
TV-32	134
TX-1	138
TX-3D	138
TZ-1	135
TZ-1D	135

### U

U- 1D	138
U- 1G	345
U- 1G NIQ	345
U- 1I	138
U- 1X	253
U- 2D	138
U- 2I	138
U- 3D	138
U- 3I	138
U- 4AD	139
U- 4AI	139
U- 4D	138
U- 4I	138
U- 4JD	139
U- 4JI	139
U- 4TD	139
U- 4TI	139
U- 5AD	139
U- 5AI	139
U- 5BD	139
U- 5BI	139
U- 5CD	139
U- 5CI	139
U- 5D	139
U- 5DD	139

REF.	PAG.
U- 5DI	139
U- 5DSP	140
U- 5ED	139
U- 5EI	139
U- 5FD	139
U- 5FI	139
U- 5I	139
U- 5JD	139
U- 5JI	139
U- 5KD	139
U- 5KI	139
U- 5MD	140
U- 5MI	140
U- 5PD	140
U- 5PI	140
U- 5QD	140
U- 5QI	140
U- 5SD	140
U- 5SI	140
U- 5SP	140
U- 5TD	140
U- 5TI	140
U- 5VD	140
U- 5VI	140
U- 5XD	140
U- 5XI	140
U- 5YD	140
U- 5YI	140
U- 6BD	140
U- 6D	140
U- 6GD	140
U- 6I	140
U- 7	141
U- 7D	141
U- 8	141
U- 8D	141
U- 8PD	141
U- 8TD	141
U- 9	141
U- 9D	141
U-10D	141
U-10I	141
U-13D	141
U-13I	141
U-14D	141
U-14I	141
U-15	141
U-15D	141
U-15GD	141
U-15GI	141
U-16	141
U-16D	141
U-17	141
U-17D	141
U-18D	142
U-19	142
U-19D	142
U-21	142
U-21D	142
U-22	142

REF.	PAG.
U-22D	142
U-25	142
U-25D	142
U-26	142
U-26D	142
U-26GD	142
UCEM- 1D	135
UCEM- 1G	292
UCEM- 1I	135
UCEM- 2D	135
UCEM- 2G	292
UCEM- 2I	135
UCEM- 3	135
UCEM- 3G	292
UCEM- 4I	135
UCEM- 5D	136
UCEM- 5I	136
UCEM- 7D	136
UCEM- 7I	136
UCEM- 8D	136
UCEM- 8DP	136
UCEM-12	135
UCEM-13D	136
UCEM-17D	136
UL-1	136
UL-2D	136
UL-3	136
UL-4	136
UMF-1	136
UN- 1FS	137-234
UN- 1G	292
UN- 2	137-234
UN- 3	137-234
UN- 4	234
UN- 5D	137
UN- 6D	137
UN- 7D	137
UN- 7I	137
UN- 8D	137
UN- 8I	137
UN- 9D	138
UN- 9I	138
UN-10D	138
UN-10I	138
UN-11	138
UN-12I	137
UN-13D	137
UN-13I	137
UN-14D	137
UN-14I	137
UN-15D	137
UN-15I	137
UN-16D	137
UN-16I	137
UN-17D	137
UN-17I	137
UN-18D	137
UN-18I	137
UN-19D	137
UN-19I	137

REF.	PAG.
UN-20D	137
UN-20I	137
UN-21D	137
UN-21I	137
UN-22D	137
UN-22I	137
UN-23D	137
UN-23I	137
UN-24D	137
UN-24I	137
UN-25D	137
UN-25I	137
UN-26D	137
UN-26I	137
UN-27D	137
UN-27I	137
UN-28I	137
UN-29D	137
UN-29I	137
UN-30D	137
UN-30I	137
UN-31D	137
UN-31I	137
UN-32D	137
UN-32I	137
UN-33D	137
UN-33I	137
UN-34D	137
UN-34I	137
UN-35D	137
UN-35I	137
UN-36D	137
UN-36I	137
UN-37D	137
UN-37I	137
UN-38D	137
UN-38I	137
UN-39D	137
UN-39I	137
UN-40D	137
UN-40I	137
UN-41D	137
UN-41I	137
UN-42D	137
UN-42I	137
UN-43D	137
UN-43I	137
UN-44	137-234
UN-44D	137-234
UN-45D	138
UN-46D	138-234
UN-47	138
UN-FFE	137-234
UN-FK	138-234
UN-FP	137-234
UN-FR	137-234
UN-FS	138-234
UN-FT	234
UN-MRN	137-234
UN-NC	234

REF.	PAG.
UN-NG	137-234
UN-NH	234
UN-NHP	234
UN-TF	234
URB-1	142
URB-1D	142
URB-2	142
URB-3D	142
URB-4D	142
URKO-1D	142
URKO-1I	142
URKO-2D	142
URKO-2I	142
URKO-3D	142
URKO-3I	142
URKO-4	142-349

### V

V-1G	345
V-1G(CV)	345
V-2G	345
V-2G(CV)	345
V-3G	345
V-3G(CV)	345
V-4G(CV)	345
V-5G(CV)	345
VA- 1	143
VA- 2	143
VA- 3	143-235
VA- 3I	143-235
VA- 4	143
VA- 4D	143
VA- 5	143
VA- 6	235
VA- 6P	235
VA- 7	235
VA- 8D	143
VA- 9D	144
VA-10	144-235
VA-11	145
VA-12D	144
VA-13D	143
VA-13I	143
VA-14D	144
VA-15	144
VA-16	235
VA-17P	235
VA-18	235
VA-19	143
VA-20	143
VA-21	143
VA-22	143
VA-23	143
VA-24D	144
VA-24I	144
VA-25	144
VA-26	144
VA-27	144
VA-28	144
VA-29	144



REF.	PAG.	REF.	PAG.	REF.	PAG.	REF.	PAG.	REF.	PAG.
VA-29D	144	VA-RH	143	VO -FHP	195	WE-5D	149	WIL-50D	150
VA-30	144	VA-RHM	143	VO -FHP1	195	WE-5I	149	WIL-51D	150
VA-31D	144	VA-RJ	143	VO -HV	195	WE-6D	149	WIL-52	150
VA-32D	144	VA-RK	143	VO -HVP	195	WEB-1	149	WIL-53	150
VA-33D	144	VA-RL	143	VO -K	195	WEB-2	149	WIL-54	150
VA-34	235	VA-RM	143	VO -L	195	WEB-3	149	WIL-55	150
VA-34P	235	VA-RN	143	VO -M	195	WEI-1	149	WIL-56	150
VA-34P1	235	VA-ROK	143	VO -MP	195	WEI-2	149	WIL-57D	150
VA-35	144	VB-1D	146	VO -N	195	WEI-3	149	WIL-58D	150
VA-35D	144	VB-2D	146	VO -NP	195	WEI-4	149	WIL-59D	150
VA-36	145	VE-1D	146	VO -R	195	WEI-5	149	WIL-60D	150
VA-37	145	VG-1D	148	VO -RP	195	WEI-6	149	WIL-61	150
VA-38	145	VGf-4D	147	VO -VA	195	WES-1D	149	WIL-62	150
VA-39	145	VGf-4I	147	VO -VAP	195	WHI-1D	150	WIL-63D	150
VA-40	145	VGf-5D	147	VO -VB	195	WIL- 1D	150	WIL-65D	150
VA-41	145	VGf-5I	147	VO -VBP	195	WIL- 2D	150	WIN- 1D	151
VA-42	145	VI- 1D	147	VO -VBP1	196	WIL- 3D	150	WIN- 1I	151
VA-43	145	VI- 1I	147	VOL-1	236	WIL- 4D	150	WIN- 2D	151
VA-44	145	VI- 2D	147	VOL-1P	236	WIL- 5	150	WIN- 3D	151
VA-45	145	VI- 2I	147	VOL-2	236	WIL- 5D	150	WIN- 4D	151
VA-46	145	VI- 4D	147	VOL-2D	236	WIL- 7	150	WIN- 5	151
VA-47	145	VI- 4DP	147	VOL-3	236	WIL- 8	150	WIN- 5D	151
VA-48	145	VI- 4I	147	VOL-4	236	WIL- 9	150	WIN- 6D	151
VA-49	145	VI- 4IP	147	VOL-5P	236	WIL-10	151	WIN-21	151
VA-50	145	VI- 5D	147	VW-K70	196	WIL-11	151	WIN-22	151
VA-51	145	VI- 6D	147			WIL-12	151	WIR-1	151
VA-52	145	VI- 7	147	<b>W</b>		WIL-13	151	WIT-1	237
VA-53	145	VI- 8	147	WA-1D	148	WIL-14	151	WM-1D	152
VA-54	145	VI- 8D	147	WA-4D	148	WIL-15	151	WM-1G	292
VA-55	145	VI- 9D	147	WA-4I	148	WIL-16	151	WM-2D	152
VA-56	144	VI-10	148	WA-5D	148	WIL-17D	151	WM-3D	152
VA-57	145	VI-11	148	WA-5DP	148	WIL-18	150	WM-4D	152
VA-58	145	VI-11D	148	WA-5I	148	WIL-19D	150	WM-5D	152
VA-59	145	VI-12	147	WA-5IP	148	WIL-20	151	WNC-1	151
VA-60	145	VI-14	148	WAL-1D	148	WIL-22	151	WST-1D	150-237
VA-61C1	235	VI-15	147	WAL-2D	149	WIL-24	150	WST-2D	150-237
VA-61C2	236	VI-16D	148	WAN-1D	149	WIL-25	150	WT-1	152
VA-62	144	VILL-1G	333	WAS - 1	236	WIL-26	150		
VA-62D	144	VIN-1D	147	WAS - 2P	236	WIL-27	150		
VA-70	145	VLK-1	148	WAS - 3	237	WIL-28	150	<b>Y</b>	
VA-75D	143	VLK-2	148	WAS - 3P	237	WIL-29	150	YA- 1D	152
VA-DHP	143	VND-1	146	WAS - 4	237	WIL-30	150	YA- 1G	327
VA-LA	143	VND-1D	146	WAS - 4P	237	WIL-31D	150	YA- 1I	152
VA-LB	143	VND-2	146	WAS - 5	237	WIL-32	150	YA- 1X	253
VA-LC	143	VND-2D	146	WAS - 5P	237	WIL-33D	150	YA- 2D	152
VA-LD	143	VND-3	147	WAS - 6	237	WIL-34D	150	YA- 2G	327
VA-LE	143	VO -1	194	WAS - 6P	237	WIL-35D	150	YA- 2I	152
VA-LF	143	VO -2	194	WAS - 7D	237	WIL-36D	150	YA- 2X	254
VA-LG	143	VO -2DP	194	WAS - 7I	237	WIL-37D	150	YA- 3D	152
VA-LH	143	VO -2DP1	194	WAS - 8	237	WIL-38D	150	YA- 3G	327
VA-LN	143	VO -2P	194	WAS - 8D	237	WIL-39D	150	YA- 3I	152
VA-RA	143	VO -2P1	194	WAS - 9	237	WIL-40D	150	YA- 3X	254
VA-RB	143	VO -5P	194	WAS - 9D	237	WIL-41D	150	YA- 4G	327
VA-RC	143	VO -6D	194	WAS -10DP	237	WIL-43D	150	YA- 4X	254
VA-RD	143	VO -7	174	WAS -10P	237	WIL-44	150	YA- 5D	152
VA-RDH	143	VO -8P	194	WBS-1	149	WIL-45D	150	YA- 5G	292
VA-RDM	143	VO -8P1	194	WE-1G	326	WIL-46D	150	YA- 5I	152
VA-RE	143	VO -AH	195	WE-2G	326	WIL-47D	150	YA- 5X	254
VA-RF	143	VO -AHP	195	WE-4D	149	WIL-48D	150	YA- 6D	152
VA-RG	143	VO -FH	195	WE-4I	149	WIL-49D	150	YA- 6I	152
								YA- 6X	254

# ÍNDICE GENERAL

## GENERAL INDEX

REF.	PAG.	REF.	PAG.	REF.	PAG.	REF.	PAG.	REF.	PAG.
YA- 7D	152	YA- 58	154	YAMA- 7I	238	YET- 3D	156	ZE- 7D	75
YA- 7I	152	YA- 58D	154	YAMA- 8D	238	YET- 4	156	ZE- 7X	255
YA- 8D	152	YA- 59	154	YAMA- 8I	238	YET- 4D	156	ZE- 8	75
YA- 8I	152	YA- 59D	154	YAMA- 9D	238	YET- 5	157	ZE- 8X	255
YA- 9I	152	YA- 72	155	YAMA- 9I	238	YET- 5D	157	ZE- 9D	74
YA- 10	153	YA- 79D	155	YAMA-10D	239	YET- 6	157	ZE- 9X	255
YA- 10D	153	YA- 81	155	YAMA-10I	239	YET- 6D	157	ZE- 10D	76
YA- 11D	153	YA- 85D	155	YAMA-11D	239	YET- 7	157	ZE- 11D	76
YA- 11I	153	YA- 88	155	YAMA-11I	239	YET- 7D	157	ZE- 13	76
YA- 12D	153	YA- 89	155	YAMA-12D	239	YET- 8	157	ZE- 14D	74
YA- 12I	153	YA- 91	154	YAMA-12I	239	YET- 8D	157	ZE- 15	75
YA- 13D	153	YA- 91D	154	YAMA-13D	239	YET- 9	157	ZE- 16D	75
YA- 13I	153	YA- 92	154	YAMA-13I	239	YET- 9D	157	ZE- 17D	75
YA- 14D	153	YA- 92D	154	YAMA-14D	239	YET- 10	157	ZE- 18D	75
YA- 14I	153	YA- 93	154	YAMA-14I	239	YET- 10D	157	ZE- 19	75
YA- 15D	153	YA- 94	154	YAMA-15D	239	YET- 11	157	ZE- 20	75
YA- 15I	153	YA- 95	154	YAMA-15I	239	YET- 11D	157	ZE- 21D	75
YA- 16D	152	YA- 97D	155	YAMA-16D	239	YET- 12	157	ZE- 22	75
YA- 17D	153	YA- 98D	155	YAMA-16I	239	YET- 13	157	ZE- 23D	76
YA- 17I	153	YA- 99D	155	YAMA-17D	239	YET- 14	156	ZE- 24D	76
YA- 18D	237	YA- 100D	155	YAMA-17I	239	YET- 14D	156	ZE- 25D	76
YA- 19D	238	YA- 101D	155	YAMA-18D	239	YET- 15	156	ZE- 26D	76
YA- 20D	238	YA- 102D	155	YAMA-18DP	239	YET- 16	156	ZE- 27D	76
YA- 20I	238	YA- 103D	155	YAMA-18I	239	YET- 17D	157	ZE- 28D	76
YA- 21D	238	YA- 108	155	YAMA-18IP	239	YU- 1D	240	ZE- 29D	76
YA- 21I	238	YA- 111	155	YAMA-19D	239	YUH- 1D	157	ZE- 30D	76
YA- 22D	153	YA- 112	155	YAMA-19DP	239	YUH- 2D	157	ZE- 31D	76
YA- 22I	153	YA- 113	155	YAMA-19I	239	YW- 1P	157-240	ZE- 32D	76
YA- 23	153	YA- 142D	155	YAMA-19IP	239			ZE- 33D	76
YA- 24D	153	YA- 186D	155	YAMA-20D	239	<b>Z</b>		ZE- 34D	76
YA- 24I	153	YA- 206D	155	YAMA-20DP	239	ZA- 1	157-240	ZE- 35	77
YA- 25D	153	YA- 208D	155	YAMA-20I	239	ZA- 1P	158-240	ZE- 35D	77
YA- 25I	153	YA- 209D	155	YAMA-20IP	239	ZA- 2P	240	ZE- 36D	75
YA- 26I	153	YA- 210D	155	YAMA-21I	239	ZA- 3D	240	ZE- 37D	75
YA- 27	153	YA- 212D	155	YAMA-21IP	239	ZA- 4DP	240	ZE- 38	75
YA- 27D	153	YA- 216	156	YAMA-22DP	239	ZA- 5DP	241	ZE- 39	75
YA- 28	154	YA- 217	156	YAMA-22IP	239	ZA- 5P	241	ZE- 40D	75
YA- 28D	154	YA- 219	156	YAMA-23DP	239	ZA- 6DP	241	ZE- 41	75
YA- 29	153	YA- 220	156	YAMA-23IP	239	ZA- 6DP1	241	ZE- 42	75
YA- 30	154-349	YA- 221	156	YAMA-24DP	239	ZA- 7DP	241	ZE- 43	75
YA- 31D	154	YA- 225	156	YAMA-24IP	239	ZA- 8P	241	ZE- 44D	75
YA- 32D	152	YA- 226	156	YAMA-25DP	240	ZA- 9P	241	ZE- 45D	75
YA- 33D	154	YA- 227	156	YAMA-26	240	ZA- 9P1	241	ZE- 46	75
YA- 34D	154	YA- 228	156	YAMA-26D	240	ZA- 10	241	ZE- 47D	76
YA- 36D	154	YA- 229	156	YAMA-26DP	240	ZA- 12	158-241	ZE- 48D	76
YA- 37	154-238	YA- 232	156	YAMA-26P	240	ZA- 13P	241	ZE- 49D	76
YA- 37D	154-238	YA- 272D	155	YAMA-27	240	ZE- 1	74	ZE- 50D	76
YA- 38D	154	YA- 273D	156	YAMA-27D	240	ZE- 1D	74	ZE- 51D	76
YA- 39	153	YAMA- 1D	238	YAMA-27DP	240	ZE- 1X	254	ZE- 52D	76
YA- 39D	153	YAMA- 1I	238	YAMA-27P	240	ZE- 2	74	ZE- 53D	76
YA- 46D	154	YAMA- 2D	238	YAMA-28P	240	ZE- 2D	74	ZE- 54D	76
YA- 50	154	YAMA- 2I	238	YAMA-29P	240	ZE- 2X	254	ZE- 55D	76
YA- 50D	154	YAMA- 3D	238	YAMA-30P	240	ZE- 3X	254	ZE- 56D	76
YA- 51	154	YAMA- 3I	238	YAR- 1	156	ZE- 4X	254	ZE- 57D	76
YA- 51D	154	YAMA- 4D	238	YAR- 2	156	ZE- 5D	75	ZE- 58D	76
YA- 52D	154	YAMA- 5D	238	YAR- 3	156	ZE- 5I	75	ZE- 59D	76
YA- 53	154	YAMA- 5I	238	YET- 1	156	ZE- 5X	254	ZE- 60D	76
YA- 53D	154	YAMA- 6D	238	YET- 1D	156	ZE- 6	74	ZE- 61D	76
YA- 57	154	YAMA- 6I	238	YET- 2	156	ZE- 6D	74	ZE- 62D	76
YA- 57D	154	YAMA- 7D	238	YET- 2D	156	ZE- 6X	254	ZE- 63D	76

REF.	PAG.
ZE-64D	76
ZE-65D	76
ZE-66D	76
ZE-67D	76
ZE-68D	76
ZE-69D	76
ZE-70D	76
ZE-71D	75
ZE-72	75
ZE-73	75
ZE-74	75
ZE-75	75
ZE-76D	75
ZE-77D	75
ZE-78D	75
ZE-79	75
ZE-80	75
ZE-81	75
ZE-82	75
ZE-83	75
ZE-84	75

REF.	PAG.
ZE-85	75
ZE-86D	75
ZE-87	75
ZE-88	75
ZE-89	75
ZE-90	75
ZE-91D	75
ZE-92D	75
ZE-93D	75
ZE-94D	75
ZE-95D	75
ZE-96D	75
ZE-97D	75
ZE-98	75
ZE-99	75
ZE-100	75
ZE-101	75
ZE-102	75
ZE-103	75
ZE-104D	75
ZE-105D	76

REF.	PAG.
ZE-106D	76
ZE-107D	76
ZE-108D	76
ZE-109D	76
ZE-110D	76
ZE-111D	76
ZE-112D	76
ZE-113D	76
ZE-114D	76
ZE-115D	76
ZE-116D	76
ZE-117D	76
ZE-118	75
ZE-119D	75
ZE-120	75
ZE-121D	75
ZE-122D	75
ZE-123D	75
ZE-124	75
ZE-125D	76
ZE-126D	76

REF.	PAG.
ZE-127D	76
ZE-128	75
ZE-129D	75
ZE-130	75
ZE-131	75
ZE-132D	75
ZE-133D	75
ZE-134	75
ZE-135D	75
ZE-136D	76
ZE-137	75
ZE-138	75
ZE-139D	75
ZE-140	75
ZE-141D	76
ZE-142	75
ZE-143	75
ZE-144D	75
ZE-145D	76
ZE-146D	76
ZE-147D	76

REF.	PAG.
ZE-148D	76
ZE-149	75
ZE-150	75
ZE-151D	75
ZE-152D	75
ZE-153D	75
ZE-154D	75
ZE-155D	75
ZE-156	75
ZE-157	75
ZE-158	75
ZE-159D	77
ZE-K1	77
ZE-K2	77
ZE-K5	77
ZE-K6	77
ZE-N1	77
ZEN-1D	158
ZI-1	241

# ÍNDICE DE MARCAS

MARKEN AURKIBIDEA

BRAND INDEX

INDEX MARQUE

HAUPTMARKE



**THE KEY TO EXCELLENCE**  
GLOBALLY UNLOCKING MILLIONS OF DOORS DAILY



**ÍNDICE DE MARCAS**

MARKEN AURKIBIDEA • BRAND INDEX • INDEX MARQUE • HAUPTMARKE

MARCA- MARKA- MAIN MARQUE - MARKE	PÁG. - ORRIA - PAGE - PAGE - SEITE
--------------------------------------	------------------------------------

45	1
126	283
303	1
333	1
3M	1
4TR	326

**A**

A.M. BARAS	1
ABA	1
ABBES	88,202
ABC	1,2
ABLOY	2
ABSA	2,3,31,113,160,222
ABT	147
ABUS	3,4,5,6,7,14,26,37,38,39,62,65,74,81,105,112,132,147,153,157,160,240,330
ACE	36
ADAMSRITE	7
ADEMCO	36,154,238
AEP	7
AGA	7,8,9,18,30,36,283,330,334,339,340
AGB	9,289
AGC	9,246
AGE	9,1
AGUEDA	127
AGUIA	10
AGUT	10
AHRAM	10
AIZPUTE	10
AKARSAN	293
AKIRA	156,157
AKS	161,185,186,188,189,194,195
AL	11
ALA	39,246
ALDRIDGE	10
ALE	10
ALEDAL	330
ALFA	8,11,66
ALIANCA	11
ALLGOOD	32
ALPHA	11,36,161
ALSO	82
ALTAY	11
ALUNORM	41
AM	101
AMARU	11
AMERICAN LOCK	12
AMERICAN MOTORS	20,82,161,162
AMIG	12,13
ANA	252
ANCHOR	3,4,5,6,12,13

MARCA- MARKA- MAIN MARQUE - MARKE	PÁG. - ORRIA - PAGE - PAGE - SEITE
--------------------------------------	------------------------------------

ANKE	29
ANKER	13
ANKERSLOT	12,91
ANLO	69
ANTAR	13,113,114
ANTONIOLI	293
APEX	13,14
APRI	100
ARCU	14,48,330,331,332
AREL	14
ARES	334,335
ARFE	3,14,44,111,160,334
ARMAN	174,179,180,236
ARMOR	113,222
ARMSTRONG	5,14
ARNOU	32
AROUCA	14
ARREGUI	3,8,14,31,55,62,160
ARROW	14
ARSENEVSK	15
ARTEB	226
ASEC	10
ASHICO	15
ASIA	15,156,157
ASPA	15
ASSA	15,16,17,115,126,161,283,284,293,332
ASSA ABLOY	155
ASTRAL	38
ATAL	88,89,143,202
ATL	28
ATLANTIC	64
ATLAS	125
ATP	31
ATRA	46,79,293,294
AUMON	17,44
AUNO	293
AUTOBLOCK	226
AVA-CHUBB	36
AVANGARD	17
AXA	161,162
AXIS	38
AYPE	332
AZBE	17,18,151
AZKOYEN	18
AZU	162

**B**

B+D	18
BAB	19,43,54,113
BAGEM	1,2,19
BALING LOCK	125
BALTIKA	20
BANE SEKULIC	26,27,142
BANHAM	20

# ÍNDICE DE MARCAS

## BRAND INDEX

MARCA- MARKA- MAIN MARQUE - MARKE	PÁG. - ORRIA - PAGE - PAGE - SEITE
BAODEAN	20
BARCZ	20
BARIER	20
BARRO	47
BASCO	20,162,200
BASI	20
BASTA	20,21,95,214,240
BATU	21,38,74
BAU	143
BELL	156,157
BENCO	127
BENDIX	153,154,238
BERAM	147
BERRY	22,23,33
BERTOLOTTI	128
BEST	21
BETA	21,294,295
BEY	21
BIBERING	21,22,130
BIELLE	22
BIFFAR	22
BILMA	22
BIRD	63,152
BKS	22,23,24,63,91,152,153,155,156,253,254
BLACK & DECKER	43
BLAU	162,182
BLOCK	227
BLOCTOUT	26
BLOCUS	110,111,113
BLOSTER	224
BLUMA	246
BMB	24
BMC	295
BMH	340
BODA	24,33,34,284,295,323
BOGATIR	295
BOINAITI	289
BOMBARDIER	163
BOMORO	25,146,163,217
BONAITI	262
BÖRKEY	25
BOSCH	163,189,217
BOULTON & PAUL	25
BOXAFE	295
BRABANTIA	25,40,54,99,163,166
BRAS	25
BRASIL	25
BRETER	157,158,240,241
BRICARD	4,25,26,38,86,92,116,246,284
BRIGGS & STRATTON	20,162,163,164,166,175,176,177,178
BRITAX	174,204
BRUMME	26,74,75
BSS	26,27
BTV	20,27,46,47,123,124,315
BUFFO	4,5,6,160
BUGA	27
BULAT	27,28
BULIT	3,82
BURG	4,5,28,29,30,43,77,106,114,147,164,223,246,247,335

MARCA- MARKA- MAIN MARQUE - MARKE	PÁG. - ORRIA - PAGE - PAGE - SEITE
BURG WACHTER	28,29,313
BURGHOWT	127
BUS	30
BUVA	28,3
BWS	41
BY	31
BYP	13,78
<b>C</b>	
C.A.R.S.	107
C.V.C.	13
CAB	30,31,153
CAF	296
CAM	323
CAM LOCK	30
CAMA	164
CAMBOA	41
CAP	31,11,111
CARAT	63,152
CARTERO	30,31
CAS	57
CAS CISMA	31,101,340
CASAS	8
CASELLAS	164
CASH BOX	31,99
CASI	117,174,175,185,186,188,191,192,194,195
CASMA	33,35
CATERPILLAR	164
CATOR	114
CAVERS	18,31,32,121
CAYS	32,44,124
CAZORLA	44
CC	127
CCF	247,248
CCL	42
CEKA	72
CEM	92,93,164,165,174,175,203,204,234
CEMA	32
CENTURION	18
CENTURY	32
CERRAMARC	32
CERUTTI	296,297,332
CES	33,34,35
CESSNA	165
CF	63,319
CFP	150
CHANGE-O-MATIC	42
CHAVO	6,36,38,39
CHELIABINSK	36
CHEYLOCK	36
CHG	65
CHICAGO	20,36,153,154,162,238
CHRIST	47
CHRYSLER	165,166
CHUBB	36,284,297
CIB	63,107,110,111,135
CIBC	63
CIBOX	28
CIEF	36
CIELS	36

MARCA- MARKA- MAIN MARQUE - MARKE	PÁG. - ORRIA - PAGE - PAGE - SEITE
CIFIAL	37,248
CILA GENTILI	37
CINA	15,37,52,119
CISA	3,4,5,6,37,38,39,92,141,298,299
CITY	31,32,63
CLARK FORK LIFT	40
CLASS	299
CLASSIC	40
CLAUSOR	40,99,165,166,167,174,175,179,189,209,210,211,212,213, 214,216,217,226,228
CLEMSA	40
CLICK	167
CLUM	167
COBRA	167,168
CODEM	63
CODKEY	121
COFER	98
COHNKO	40
COLE HERSEE	153
COLOMENCA	8
COM	40
COMBA	33,85,130
CORBIN	41,42,43,48,49,50,162
CORNI	127,289,300
CORONA	43,44,77
CORSA	126
COTICO	44
COUILLET	112
CR	254,300, 301
CRAIN	90
CRAZY LOCKS	44
CRC	41
CRC CAMBOA	248
CROMODORA	224
CRONOS	335
CUBELLS	44
CVL	44
CWS	47
<b>D</b>	
DACIA	168
DAD	44,46,47,62,124,144
DAELIM	168
DAEWOO	168,169
DAF	45
DAIHATSU	169
DAMM	22,23
DAR-MAR	285
DARMIX	169
DATSUN	213,218,219,220
DAV	169
DC	113
DEBEAURAIN	70,113,136,248,285
DECAYEUX	44,107,112
DEFA	45
DEHA	156,157
DEKABA	45,302
DELAPORTE	45,46
DELCA	46

MARCA- MARKA- MAIN MARQUE - MARKE	PÁG. - ORRIA - PAGE - PAGE - SEITE
DELTA	113
DERLOCHE	113
DESAL	29
DESPREZ	113
DEXTER	46,163
DIAMOND	46
DIEBOLD	46,349
DIERRE	46,98
DIFA	114
DIMITROVGRAD	46
DIRAK	45
DJC	127
DKW	162
DNS	71
DOBLE G	169
DOBLE SAFE	93,94,203
DOBLINA	169
DOCO	43
DOM	41,46,47,48,49,50,51,102,103,124,169,170,174,194,227, 236
DOMINION LOCK	14,51
DOMUS	31,51,52,311
DONNER	127
DOOR LOCK	248
DOUBLE CIRCLE	52
DRAPER	155
DUBOIS	88,89,170,202
DUPLEX	335
DURABLE	28
DURALOCK	52
DVERNIAK	302,303,335,336
<b>E</b>	
EAG	52
EAGLE	52,71
EAO	49
ECHO	170
ECM	52
EFER	37
EIKO	52
ELBOR	303
ELCA	55,56,127
ELEPHANT	133
ELFIN	32
ELMO	20,162
ELSET	99
ELZETT	33,53,285, 286,304
EMGE	113
EMHART	48,49, 50, 113, 222
EMKA	45,53, 54
EMOH	162
ENA OQ	135
EP PINSON	53
EPO	117
EQUIBATIR	113
ERA	53,54, 286
EREVAN	304,336
ERINRUDE	222
ERMEX	126

# ÍNDICE DE MARCAS

## BRAND INDEX

MARCA- MARKA- MAIN MARQUE - MARKE	PÁG. - ORRIA - PAGE - PAGE - SEITE
ESA	54,286
ESAFE	36,46, 47, 98, 124, 127, 136, 139
ESCO	6,38, 39, 41, 42, 127
ESETY	304,305
ESLA	54
ESS	54
ESSENDIA	6,38, 39
ESZ	80
ETAS	54
ETNA	31,109
EUREKA	54
EURO	44
EURO BOX	54
EURO LOCKS	21,36, 54, 55, 92, 93, 94, 170, 203, 204
EURO PRO	148
EURO SPEC	138
EURONORM	41,42
EUROP	125
EUROPARTNER	41
EUROPROFIL	67
EUROTEMPLE	305,306
EVERGOOD	55,12
EVVA	55,56
EXCEL	56
EXPRES	56,65, 91, 92, 157
EZCURRA	56,57, 117, 118, 306, 307
EZSET	86
<b>F</b>	
FAAB	170
FAB	57,69, 170,171
FAC	7,30, 31, 58, 59, 84, 124, 127, 146, 307
FACEF	311
FADE	74,112
FAI	148
FAICA	171
FAINER	59
FALCON	21,59,149
FAMA	59
FANA	26,59
FARMA	171
FAS	59
FAS - YALE	286,287
FASEM	22,59
FASMA	55
FAVOUR	59
FAYN	60,248
FB	8
FCV	60,85
FEB	11,36, 82, 109, 161, 307
FECHADURA	60
FECOR	46, 47, 334
FEDERAL	60, 64, 65
FEFI	33
FEL	119
FEMSA	171
FERMABLOCK	106
FERMOD	44
FERONERIA	60

MARCA- MARKA- MAIN MARQUE - MARKE	PÁG. - ORRIA - PAGE - PAGE - SEITE
FETIS	307
FF	60,61
FH	340
FHUR	80
FIAM	248, 254, 308, 309
FIAT	171
FIC LOCKS	61
FICHET	22, 61, 88, 130, 149, 287, 310
FINSTRAL	66
FISAM	171
FIST	62, 164, 171, 179, 223, 224
FLAMBO	50, 170
FLIETHER	85
FLIK	65
FLOHR	62
FLORA	62, 162, 171
FO	31, 32, 103
FONTAINE	62, 113, 143
FORCE	68
FORD	171, 172, 173, 174, 175
FORINDEX	113,222
FORT	14, 36, 62, 77, 154, 162, 238
FORTE	62
FORTIS	63
FORTRESS	127
FOUR CIRCLE	156, 157
FPB	109
FRAL	109
FREA	224
FRECOV	33
FRIPA	63, 249
FROSER	3, 113, 160, 222
FT	70
FTH	3, 13, 63, 64, 65, 72, 129
FUCHS	41
FUHR	33
FULLEX	65
<b>G</b>	
GABON	65
GAINSBOROUGH	92,127
GALLUS	65
GAMMA	104
GAMMET	65
GAON	84
GARDIAN	310
GARI	8
GAS	175
GATO	65
GAZ	236
GBS	150
GBZ	65
GE GE	6, 11, 27, 65, 66, 123
GEBA	22, 23, 66
GEBRO	43
GEFI	6, 38, 39
GELBAU	127
GELBON	202, 203
GEM	36



MARCA- MARKA- MAIN MARQUE - MARKE	PÁG. - ORRIA - PAGE - PAGE - SEITE
GEMINI	82
GEMM	87, 88
GENERAL MOTORS	175, 176, 177, 178
GERA	66, 67, 117, 249
GERDA	67
GETE	6,38,39
GEVY	20,46
GEWIRU	51
GEWU	178
GHE	178
GIBBONS	67
GIESCHE	33,85
GIMAST	310
GIMN	113
GIOBERT	167, 179, 180, 181, 182, 224, 234
GIPIS	310
GIUSSANI	67,68
GLAZIEV	68
GLOBE	68,69
GLOSTAL	65
GMB	12
GMG	310
GODREJ	69
GOLD DOOR	68, 69
GOLLOT	113
GOTZ	85
GOYAL	8
GPZ	287
GR	69
GRAF	85
GRAYHILL	77
GRUNDMANN	65
GSA	31
GTV	6, 38, 39, 69, 80
GUARD	69, 70, 74
GUARDIAN	31, 60, 288
GUERVILLE R.	70
GUIDOTTI	113
GUITTEL	4, 5
GUTLER	119
<b>H</b>	
HÄFELE	33, 34, 46, 47, 70, 72, 88, 89, 202
HAGA	70
HAIDE	156, 157
HALLE	70
HAMA	182
HAMPTON	132
HANNO	33
HARKOV	71
HARLEY DAVIDSON	182
HARLOC	71, 127
HASLER	117, 118
HAYWORTH	71
HB	71
HBC	100
HEAD	156, 157
HEGO	41
HEKNA	46, 47, 50, 71

MARCA- MARKA- MAIN MARQUE - MARKE	PÁG. - ORRIA - PAGE - PAGE - SEITE
HELCO-KFV	249
HELIX	71
HEMA	143
HEMY	156, 157
HENDERSON	71, 288
HERACLES	64
HERME	71
HERMES	156, 157
HERO	106
HERPE	127
HERSEE	20, 162
HESTE	41
HEVY	28
HILLMANN	128
HINO	233
HK	162
HOBBY	55, 170
HOBES	72
HOHRMANN	22, 23, 33, 47, 65
HONDA	182, 183, 184, 185
HOPPE	28
HORSE	72
HRG	106
HSA	85
HTEC	72
HTV	72, 119
HUDSON	72, 185
HUF	168, 172, 174, 185, 186, 187, 188, 189, 190, 191, 192, 193, 194, 195, 196
HUNIT	72
HUTRA	117
HUWIL	46, 47, 72, 73, 196
HYMER	55, 170
HYUNDAI	196, 197, 198
<b>I</b>	
I.R.	152
IACAM	180
IBEAR	73
ICA	73
ICSA	73, 90
IDEAL	47
IDEAL SECURITY	149
IDM	311
IFAM	18, 43, 63, 64, 73, 74, 78, 124
IFOS	126, 127
IGS	74
IKON	43, 44, 74, 75, 76, 77
ILARGI	32, 77
ILCO	77
ILLINOIS	20, 36, 77, 154, 162, 238
ILS	77
IMB	77
IMBAC	111
IMP	3, 4, 5
IMSA	191, 198, 199, 224
INCECA	78
INDAK	229
INDAUX	14

# ÍNDICE DE MARCAS

## BRAND INDEX

MARCA- MARKA- MAIN MARQUE - MARKE	PÁG. - ORRIA - PAGE - PAGE - SEITE
INGERSOLL	78
INLOC	26
INSTALL	127
INT	78
IR	78
ISEO	3, 32, 78, 79, 110, 136, 143, 235, 249, 289, 309, 311, 312
ISKU	106
ISSERSTEDT	41
ISUZU	199
ITAL	312
ITEM	29
ITO	6, 38, 39, 79
IVANA	79

### J

JARDI	79, 80
JD	11, 114, 161
JET	3
JINLONG	80
JIP	80, 110, 111, 113
JIS	80, 84
JJ	44
JL	63
JMP	3, 6, 38
JOHN DEERE	199
JOMA	31, 73, 74, 80, 120
JORE	150
JOSTA	33
JOVI	7, 80
JOWIL	69, 80, 81
JPM	3, 81, 85
JTF	81
JU	89, 144, 202
JU JUNGINGER	82
JUGODENT	174
JUNGHEINRICH	82
JUNGST	80
JUNIE	82
JUNKUNC	82
JUWEL	313
JUZU	82
JVAL	82

### K

K+K	98
KABA	82, 83
KABS	83
KALE	3, 83, 84, 313
KALUGA	84
KAMAZ	199
KAP	84
KARDEX	33, 113, 222
KARO	64
KASSBOHRER	178
KASSEL	314
KATE	119
KAWASAKI	199, 200
KAWE	41, 42, 127, 149
KAZAN	84, 85
KEMEN	7, 8, 106

MARCA- MARKA- MAIN MARQUE - MARKE	PÁG. - ORRIA - PAGE - PAGE - SEITE
KENWORTH	200
KERBEROS	314
KESO	85
KEYA	2, 3, 160
KFV	85
KIA	200, 201
KICHINEV	85
KIFER	7
KIFERM	85, 88, 89, 112, 165, 202, 221
KIMA	33
KIND	28, 33
KIROVMACH	86
KITTY	2
KLIT	143, 235
KN	162
KNAPP	33
KOLB	163, 172, 173, 174, 175
KOMATSU	201
KP	86
KRAMATORSK	86
KREMENCHUG	86
KREPISH	315
KRESTI	250, 251, 252
KROST	30
KUNERT	38
KURZEME	315
KVR	31
KWIKSET	86
KYMCO	201
KYNNARPS	86
KYR	118

### L

LABOFA	66
LADA BAKONY	201, 202
LAFONTE	86
LAGRANDE	77
LAMA	100, 129
LAMPA	32
LANE	43
LAPERCHE	31, 86, 87, 88, 113, 114, 143
LAPORTE	25, 88, 163, 222
LAR	288, 332
LAREDO	63, 152
LARK	68, 88
LAS	88, 89, 112, 202
LASBOLAGET	82, 89, 119, 288
LEFEBURU	37
LEGALLAIS	71, 89
LEGGE	89
LEN-LOK	92
LEROY MERLIN	79
LG	14
LINCE	11, 89, 90, 161, 315
LINDE	162
LION	82
LIONA LIOX	113
LIPS	90, 91, 111
LISTA	47

MARCA- MARKA- MAIN MARQUE - MARKE	PÁG. - ORRIA - PAGE - PAGE - SEITE
LITTO	13, 41, 91
LM	126
LMP	202, 203
LOB	91, 92, 98, 157
LOCK	92
LOCK-IT	252
LOCKSYS	121
LOCKWOOD	92
LOGO	92, 141
LORI	71
LOTUS	156, 157
LOWE & FLETCHER	36, 55, 92, 93, 94, 95, 203, 204, 205
LT	95
LUCKY	95
LUCO	69
LUMA	95
LUME	67
LUXOR	127
LYF	96
<b>M</b>	
M.LUNA	2, 160
MACK	205
MACOR	336
MAFOR	113, 252
MAGNETI MARELLI	179, 224, 226
MAGNUM	96
MARCADET	88, 89, 202
MARIANI	96
MARK	133
MARQUES	96
MARS	54
MARUTI	205
MASTER	41, 96, 97
MASTER LOCK	97
MASTERCRAFT	127
MATTEY	125
MAUER	45
MAUSER	33, 72
MAVE	289
MAXIGARD	65
MAXIM	336
MAXUS	97
MAZDA	205, 206, 207
MBB	33
MCL	97
MCM	97, 98, 99, 288, 289, 315
MD	78, 79
ME FA	99
MECALUX	7, 46, 47
MECO	99
MELSMETALL	28, 99, 100
MENOVA	47
MERCURY	167
MERIT LINDE	207
MERKUR	80
MERMIER	41, 43
MERONI	100, 101
METAL	101, 315, 316

MARCA- MARKA- MAIN MARQUE - MARKE	PÁG. - ORRIA - PAGE - PAGE - SEITE
METALCASTELLI	71, 111
METALCHIMEX	127
METALUX	101, 127, 143
METEOR	22, 46, 47, 89, 101, 202
METIZ	101
METTEM	303
MG MONTI	101
MIA	323
MIAN	68
MIBRA	93, 204
MICHEL SEAT	101, 107
MIGNON	152
MILA	101, 102
MILES	102
MING TAY	102
MINI MOLA	252
MIRAGLIO	224
MISCELLANEOUS	207
MITSUBISHI	207, 208, 209
MIWA	102
MLM	46, 47, 102, 103, 113, 124, 222
MOBELLA	103
MODERN	143
MOFA	164
MOFLEX	106
MOGILEV	103
MOIA	316
MON	103
MONACOR	11, 161
MONDIAL	70, 113, 209
MONOBLOC	32, 103
MOREAUX	47, 49, 113, 148, 252
MOSKVA	289
MOSKVITCH	209
MOSRENTGUEN	103
MOTTURA	104, 316, 317, 318, 319
MP	289
MP PLODARI	104
MR	126
MSM	104
MST	31
MSV	104, 252
MUKRA	41, 42
MULTLOCK	104, 105
<b>N</b>	
NABOB	252
NATIONAL CABINET	105
NB	6, 38 39 62
ND	135, 136
NEIMAN	163, 165, 174, 175, 179, 180, 185, 187, 188, 194, 195, 196, 209, 210, 211, 212, 213, 214, 215, 216, 217, 218, 224, 225, 226, 235
NEMEF	33, 35, 41, 113, 222, 253, 340
NEWMAN TONKS	127
NICO	63, 85
NISSAN	218, 219, 220, 221
NOBO	47, 50, 169
NORDWEST	62, 117
NOVA	105, 132

# ÍNDICE DE MARCAS

## BRAND INDEX

MARCA- MARKA- MAIN MARQUE - MARKE	PÁG. - ORRIA - PAGE - PAGE - SEITE
NOVOFERM	41
NUMIDA	54, 113
<b>O</b>	
OAL	43, 67
OASA	289
OCARIZ	105
OCTAVO M.	105
ODA	13, 36
OFITA	105
OIAUS	9
OJMAR	33, 105, 106
OLIVA	106
OLIVETTI	107
OMA	107
OMEC	107, 319
OMIV	22, 107
OMR	101, 107
ONIUM	138
ORBA	119
ORDO	88, 107, 202
ORENGO	8, 289, 319, 333
ORION	127
ORION NOVOX	107
ORLANDO	73
ORO	108
ORONA	244
ORSHA	108
OSKO	80
OSMET	289
OSTMARK	289
OTIS	74, 75, 77
<b>P</b>	
P&C I.	108
PADO	108
PANTHER	80
PAPAIZ	108, 253
PAS	111
PASSEPARTOUT	289
PASSY	112
PASTORE	110, 111
PATENT	289
PATRONE	319
PAYKAN	128
PB	106
PC	22, 82, 109
PEBRA	186
PENT	136
PENZMASH	109
PERINO	289
PEROHAUS	50, 65, 66, 82, 178
PERRIER	70
PETERBORO	51
PETROZAVODSK	109
PFÄFFENHAIN	109, 110
PGO	221
PH	136
PHILLIPS	25, 110
PHOENIX	110

MARCA- MARKA- MAIN MARQUE - MARKE	PÁG. - ORRIA - PAGE - PAGE - SEITE
PICARD	21, 110
PICARDIE	6, 1295
PJ	89, 113, 165, 202, 221, 222
PK	89, 202
PLUS	5
PM	113
POLAR	163
POLLAK	222
POLLUX	110
POS	162, 178, 222
POTENT	101, 110, 320, 321
PP	44
PRAZIS	254
PREFER	106, 110, 111, 321, 336
PREMI	100
PRESTA	25, 163, 222
PROAUTO	3, 160
PROBAT	63
PROGRES	62
PROMO	110, 111
PROTEC	31
PZ	22, 23
<b>Q</b>	
QCM	44, 135
QCP	31
<b>R</b>	
RADIAL	144, 145
RAM	156, 157
RAUCO	71
REDY	92
REGAL	111
REGENT	71
REMO	73
RENAG	290
RENZ	46, 47, 88, 89, 111, 112, 202
REVI	321
REX	112, 290
RGM	112
RIAZIAN	112
RICOUARD	112
RIGA	112
RIGAL	322
RIL	112, 349
RIPA	74, 112
RITA	112
RITTAL	28, 29
RIV	135
ROC	63, 152
RONEO	7, 113, 146, 222
RONIS	87, 88, 113, 114, 202, 222, 223, 252
ROOL A DOOR	18
ROOTES	204
ROS	202, 203
ROSS	165, 223
ROSSETTI	114
ROTO	28, 67
ROYAL	4, 5, 114, 147, 156, 157
RS	106



MARCA- MARKA- MAIN MARQUE - MARKE	PÁG. - ORRIA - PAGE - PAGE - SEITE
RST	25
RUBEN	322, 333, 336
RUE	333
RUFFINI	224
RUKA	46, 47, 144
RUKO	114, 115
RUNO	171
RUSSIA	115
RUSSWIN	115
RUTALCHI	8
<b>S</b>	
SAAB	223
SAB	323
SABT	116
SADV	27, 113, 222
SAFE	182, 198, 199, 223, 224, 226, 323
SAG	305, 306, 311
SAM	116, 323
SAMSONITE	116
SANCHUN	156, 157
SANEL	113, 222
SANPEUR	145
SANTIS	33
SANTOS	107, 109
SANY	11, 161
SARGENT	116
SATURN	20, 117
SCHAFFER	222
SCHARER	117
SCHARF	72
SCHLAGE	18, 117
SCHLECHTENDAHL	117
SCHLEGEL	46, 47
SCHRITT	77
SCHUCO	3, 6, 38, 39, 85, 117
SCOVILL	18
SCUDO	9
SE	70, 127
SEA	117, 118
SECURE	122
SECUREMME	118, 323, 324
SECURIKEY	54, 100
SECURITAL	62, 118
SEEBURG	77
SEIMA	202, 203
SELECT	118
SELIVANOVSK	118
SEMEL	80, 123
SEN	85
SENTRY SAFE	118
SERMEC	324
SERRALLER	8, 44, 73, 118, 124, 337
SERRETA	118, 349
SES	127
SESA	113, 114
SEZAN	156, 157
SHANGAI	119
SHAW	119

MARCA- MARKA- MAIN MARQUE - MARKE	PÁG. - ORRIA - PAGE - PAGE - SEITE
SHILUTE	119
SHOWA	116
SIAM	31, 119
SIAS	324
SIB	32, 90
SIBI	324, 325, 337
SIDERAL	325
SIDESE	119
SIDLEEN	56
SIEBAU	33, 130
SIL	59, 120, 139
SIMATIC	119
SIMECA	67, 119
SIMPLEX	113, 222, 224, 225, 226, 235
SINJET	47
SIPEA	179, 180, 181, 224, 226
SIS	119, 120
SISO	31, 56, 106, 120
SISPA	222, 226
SJL	120
SKILMANN	42
SMET	289
SOFER	120
SOFI SONAFI	120
SOLER	120
SOLID	33
SOLOR	114
SONICO	40
SOPRANO	120
SOS	31, 65, 121, 127, 252
SP	64
SPEEDAL	33, 35
SPIDER	121
SQUIRE & SONS	121, 122
SS	33
SSANGYONG	226
STA LOCK	122
STAM	60
STANDARD	6, 38, 39
STAR	122
STARLET	122
STEELCASE	36, 72, 196
STEIGA	47
STEKLOMASH	122
STEM	123
STERLING	123
STIQAM	31, 135
STIQUAM	289
STRAFOR	72, 88, 113, 114, 196, 202, 222, 223
STRATTEC	173
STREBOR	123, 203, 227
STREMLER	25, 31, 41, 113, 143
STS	30, 46, 47, 51, 123, 124, 127, 227
STUBLINA	124
STUMPF	124
STUMPF METALL	106
STUV	33, 47, 51, 102, 103, 113, 124, 125
STV	107
SUBARU	227

# ÍNDICE DE MARCAS

## BRAND INDEX

MARCA - MARKA - MAIN MARQUE - MARKE	PÁG. - ORRIA - PAGE - PAGE - SEITE
SUF	63
SUKI	62
SUL	41
SUREX	125
SURFINOR	61
SUYOKA	7
SUZUKI	227, 228, 229
SWAN	156, 157
SWEDA	111
<b>T</b>	
TAITO	125
TALLINN	125
TANLOCKS	89
TAP-AGIS	229
TARONI	126
TAS	21
TATA	229
TAYLOR	126, 127
TAYMOR	127
TECHNAL	127
TECNO	73, 138, 196
TECNOLAR	124
TECNOR	61
TECON	126
TECSESA	124, 126, 325
TECUMSEH	229
TEICOCIL	59, 126, 127, 132
TEKA	15, 126
TELFORD	93, 203
TEM	74, 126
TERCA	8
TESA	3, 74, 78, 126, 127, 147, 247, 290
TESIO	4, 325
TESTA	31
TH	128
THOMAS LAIDLAW	127
THONE	41
THT	72
TIBBE	187, 229
TICINO	128
TIEFENTHAL	53, 69, 80
TIFON	128
TIGRIS	128
TITAN	86, 128, 129, 229
TITANO	326
TITUS	152
T-KEY	125
TM	47
TOK	22, 237
TOK WINKHAUS	130, 131, 237
TOKAJ RIKA	177, 230, 231, 232, 233
TOMSK	132
TOOL BOX	229, 230
TOP	105, 132
TOPLOCK	127
TOVER	20, 63, 132, 326
TOY	2
TOYOTA	230, 231, 232, 233

MARCA - MARKA - MAIN MARQUE - MARKE	PÁG. - ORRIA - PAGE - PAGE - SEITE
TRAMA	223, 224
TRAVEX	132
TREE	39
TRELOCK	130, 131, 132, 144, 233, 237
TRI CIRCLE	52, 133
TRI STAR	134
TRIMARK	134
TRINITY	102
TRIO	134
TRIO-VING	134, 246, 290, 291, 292
TRITON	33, 80
TRIUMPH MOTORCYCLE	233
TROMER	98, 101, 132
TRUMPH	128
TRUPER	134, 135
TRW-SIPEA	234
TRYBA	56
TSAG	135
TUFF	253
TULA	135
TÜRSCHLOSS	21
TUSHINO	135, 326
TUTIS	53
TZAFRER	37, 65, 135
<b>U</b>	
UBE	185, 186, 188, 194, 195
UCEM	44, 135, 136, 146, 292
ULIANOVSK	136
ULTRA	93, 94, 204
UMF	136
UNIFOR	110
UNION	92, 93, 137, 138, 203, 204, 227, 234, 292
UNIPART	
UNIVERSAL	138, 139, 140, 141, 142, 253
URBIS	142
URKO	142, 349
US	82
UTZ	93, 119, 204
<b>V</b>	
VACHETTE	78, 79, 86, 88, 129, 130, 143, 144, 145, 146, 224, 225, 235, 236, 340
VAGO	111
VALEO	217, 219, 220, 232, 236
VARIOS	146
VAUGHN	72, 119
VBH	146
VDO	189
VEGA	13, 113, 146
VELO	156, 157
VENDI	146, 147
VENLOCK	127
VERA	117
VERSCO	41
VG F VILLATORE	147
VIDMAR	117, 118
VIKI	47
VILLFER	333
VINCO	143, 144

MARCA- MARKA- MAIN MARQUE - MARKE	PÁG. - ORRIA - PAGE - PAGE - SEITE
VING	147
VIP	31
VIRO	2, 147, 148, 240
VISO	156, 157
VISONIC	11, 161
VOKO	33, 80
VOLGA	236
VOLGOGRAD	148
VOLKOVYSK	148
<b>W</b>	
WALE	152
WALLY	148
WALRUS	148, 149
WANJIN	149
WASO	33, 162, 174, 218, 220, 236, 237
WEBER	149
WEBSTER	149
WECO	22, 33, 149, 152, 178
WEDO	54
WEISER	59, 149
WELKA	149, 326
WEPA	80
WESCO	162
WESLOCK	149
WEST LOCK	150, 237
WHITCO	150
WIGRO	150
WILKA	150, 151
WILLENHALL	67
WILMOT BREEDEN	204, 205
WINFIELD	156, 157
WINKHAUS	151
WINLOCK	151
WINNER	65, 70
WIREROPE	151
WITTE	185, 186, 187, 188, 194, 195, 237
WMS	152, 292
WOC	63, 152
WSM	28
WT	152

MARCA- MARKA- MAIN MARQUE - MARKE	PÁG. - ORRIA - PAGE - PAGE - SEITE
<b>Y</b>	
YAC	113, 222
YALE	20, 22, 23, 40, 63, 119, 152, 153, 154, 155, 156, 162, 165, 166, 237, 238, 253, 254, 292, 327, 349
YALTRES	25, 63
YAMAHA	238, 239, 240
YANEDIS	54
YARD	157
YARDENI	156, 157
YEMAR	127, 136
YETI	92, 98, 156, 157
YMOS	174, 179, 185, 188, 190, 191, 192, 193, 215, 216, 223
YUGO	240
YUN HUAN	157
YVEL	112, 170
YWS	157, 240
<b>Z</b>	
ZADI	157, 158, 233, 240, 241
ZAIN	17, 18
ZANI	73
ZAZ	236
ZECE	41
ZEISS IKON	254, 255
ZENI	32, 158
ZENICA	31
ZENITH	31, 32, 119
ZIL	199, 241
ZUNDAPP	178

# ***LLAVES PLANAS PARA CERRADURAS DE CILINDRO***

*SARRAILA ZILINDRIKOTARAKO GILTZA ZAPALAK*

*CYLINDER KEYS*

*CLES POUR CYLINDRES*

*ZYLINDERSCHIÜSSEL*



***THE KEY TO EXCELLENCE***

*GLOBALLY UNLOCKING MILLIONS OF DOORS DAILY*





45

303

333

PARA-FOR:

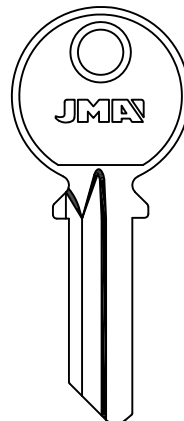
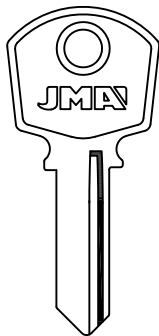
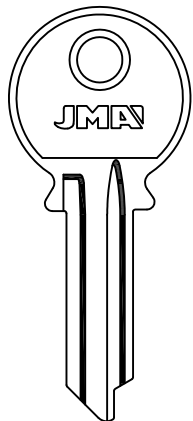
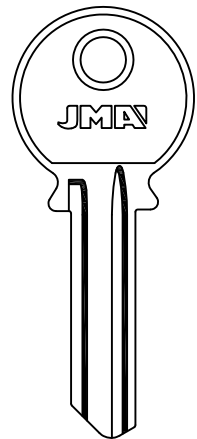

45 (RUS)

303 (RC)

333 (IL)

3M (PRC)

A.M. BARAS (GB)

ABA (SF)

ABC (E)



45-1

45-1D

45-2

45-2D

303-1

303-1D

333-1D

333

3M

A.M. BARAS

ABA

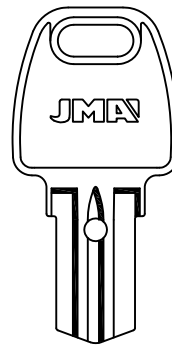
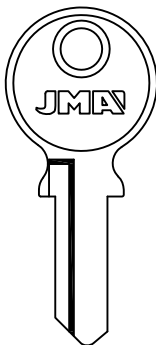
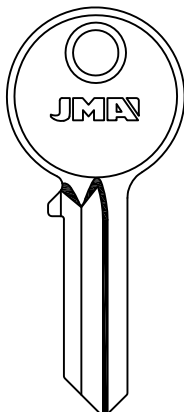
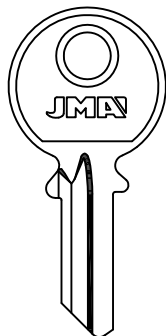

LAT.



333-2D



3M-1D



AMB-1



AMB-1D



ABA-1

ABC

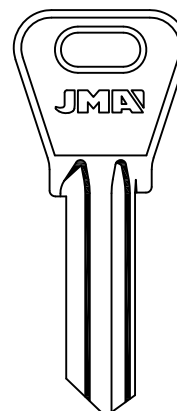
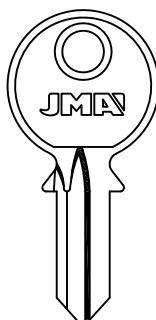
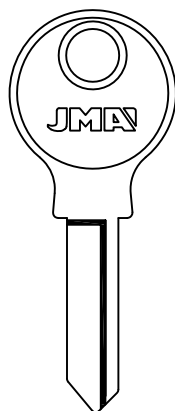
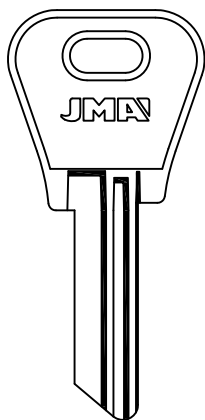

11A  
ABC-1

BAGEM



N  
ABC-2



B2  
ABC-3D



A1  
ABC-5I



A2  
ABC-5D

BAGEM

**JMA**<sup>®</sup>



Copyright by Alejandro Altuna S.A. 2014











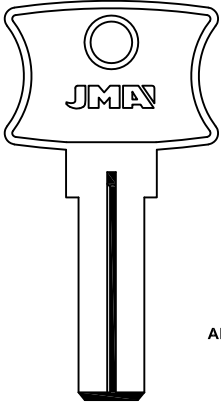
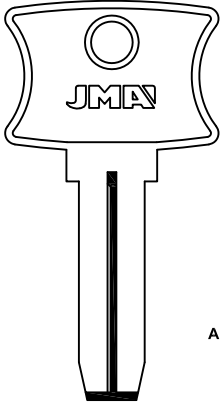
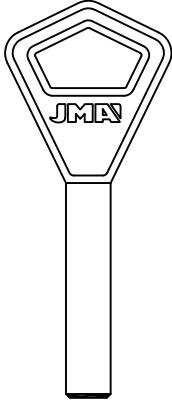
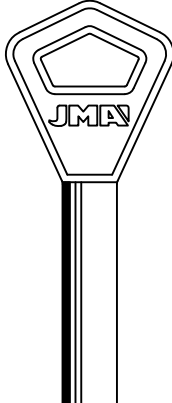



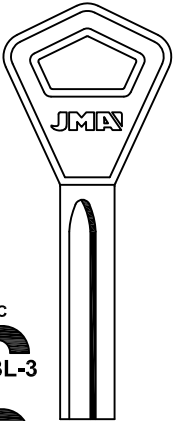
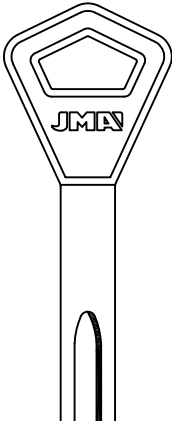
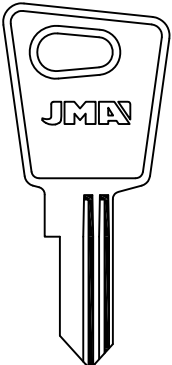
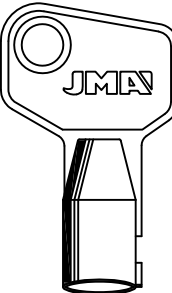



ATENCIÓN: Concerniente a las marcas y denominaciones comerciales ver nota en índice.  
ATTENTION: Concerning the marks and commercial denominations see note in index.  
ATTENTION: Concernant les marques et dénominations commerciales voir la note dans l'index.  
ACHTUNG: Beziehen auf die marke und handelsname sehen sie die notiz im index.

**PARA-FOR:**

ABC (E)

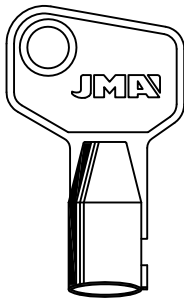
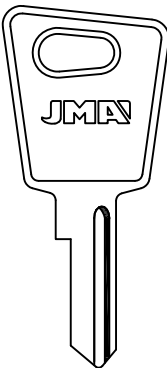
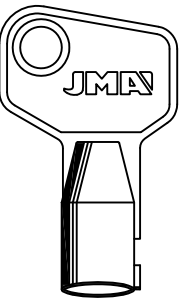
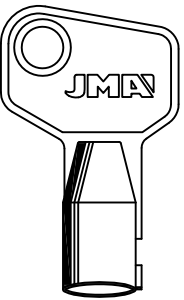
ABLOY (SF)

ABSA (E)

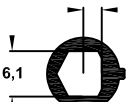
ABC		ABLOY	
			
ALP.	ALP.	LAT. ACE.	LAT.
			
ABC-6 BAGEM	ABC-7 BAGEM	ABL-1 KITTY-VIRO	ABL-2
ABLOY		ABSA	
			
LAT.	LAT.		ZAM.
			
ABL-3	ABL-5	AB-11 M.LUNA	AB-1T KEYA
			
ABL-4		AB-1D	
			
ABL-6		AB-21	
			
		AB-2D	
ABSA			
			
ZAM.		ZAM.	ZAM.
			
AB-2T KEYA-TOY	AB-3I M.LUNA	AB-3T KEYA	AB-4T KEYA



## ABSA

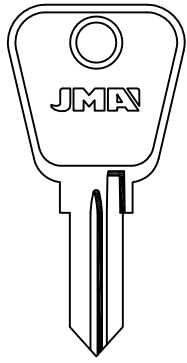

14  
AB-5I

FROSER

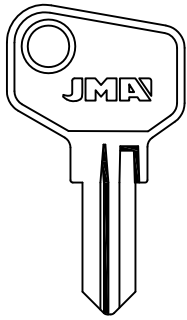

15  
AB-6I  
PROAUTO



14  
AB-8I  
ARREGUI

ARFE-FROSER-KEYA

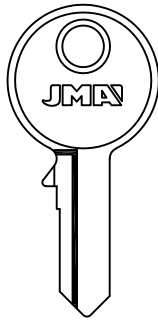

8  
AB-9D

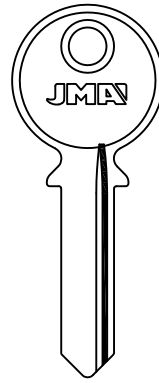

AB-11

KEYA

## PARA-FOR:

ABSA (E)

ABUS (D)

## ABUS

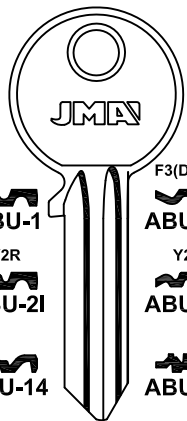

ABU-1

Y2R  
ABU-2I

ABU-14

ABU-44

ABU-46

F3(D)-Y1  
ABU-1D

Y2L  
ABU-2D

ABU-7D

ABU-43D

ABU-46D

R008  
ABU-49

ABU-53

X4S  
ABU-55

ABU-67

ABU-69

ABU-74

X2S  
ABU-76

ABU-52D

ABU-55D

ABU-67D

ABU-71D

ABU-74D

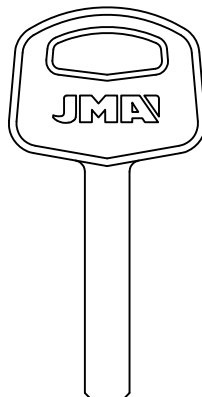

GRANIT

ABU-3

BULIT

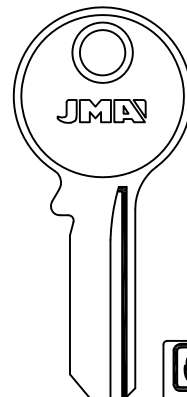

ABU-4I

ABU-15

ANCHOR-JET-JMP-KALE-TESA



50

LAT.

CISA-ISEO-JPM-SCHUCO

## ABUS

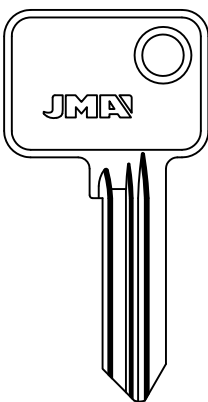

ABU-6I

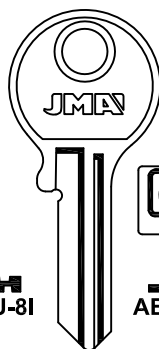

ABU-8I

ABU-12I

ABU-5D

ABU-6D

ABU-20

ABU-47

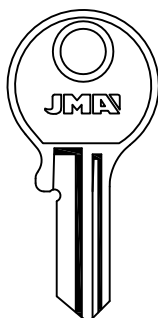

ABU-9I

ABU-9D

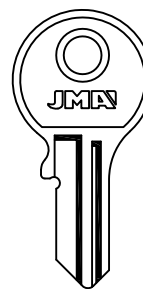

ABU-10I

ABU-10D



30

ABU-37D

ANCHOR-FTH-IMP

**JMA**<sup>®</sup>

Copyright by Alejandro Altuna S.A. 2014



ATENCIÓN: Concerniente a las marcas y denominaciones comerciales ver nota en índice.  
 ATTENTION: Concerning the marks and commercial denominations see note in index.  
 ATTENTION: Concernant les marques et dénominations commerciales voir la note dans l'index.  
 ACHTUNG: Beziehen auf die marke und handelsname sehen sie die notiz im index.

PARA-FOR:

ABUS (D)

ABUS

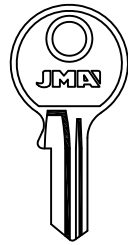

ABU-11 ABU-11D  
CISA

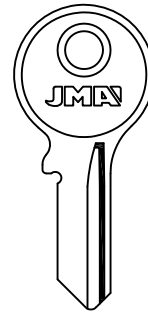

ABU-13



ABU-13D  
ABU-21  
ANCHOR-BURG  
GUITTEL-IMP-ROYAL

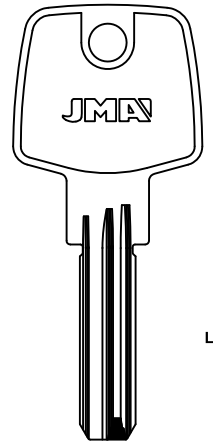

LAT.

7.35  
AAL  
2.35  
ABU-16  
EXTRA CLASSE  
CISA-BRICARD

ABUS

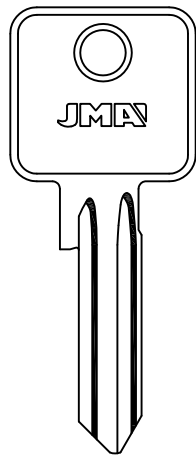

ABU-17 ABU-17D

CISA

ABU-48

K1D  
ABU-70

ABU-77

ABU-80

ABU-83

X4S  
\* ABU-85

ABU-58D

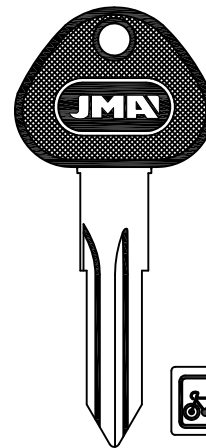

Z71....1-1043  
Z72....1-1043

ABU-18.P ABU-18D.P

BUFFO

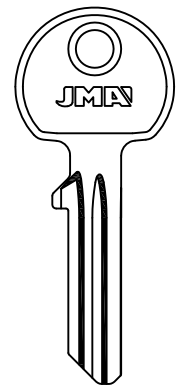

Z71....1-1043  
Z72....1-1043

ABU-19D

BUFFO

ABUS

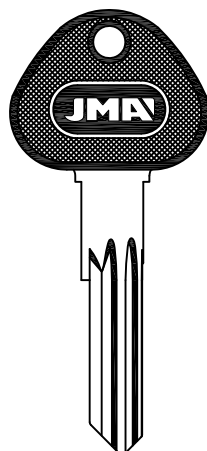

Z71....1-1043  
Z72....1-1043  
ABU-19.P ABU-19D.P

BUFFO

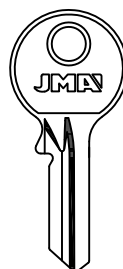

ABU-22D

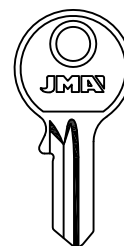

ABU-23D

CISA

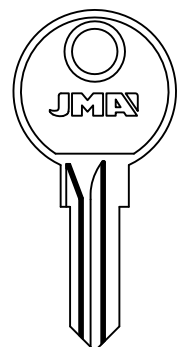

ABU-24D





## ABUS

PARA-FOR:

ABUS (D)

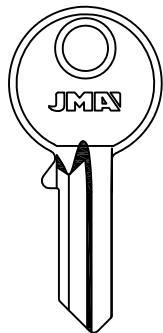

ABU-25D

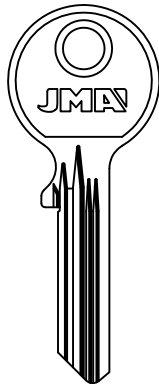

ABU-26D

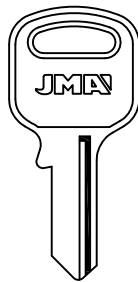

ABU-27



30-35

ABU-27D

CISA

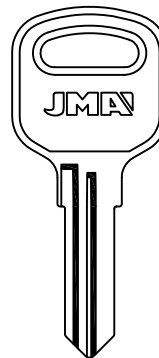

ABU-28

ARMSTRONG-BUFFO

## ABUS



ABU-29.P

PLUS

ALP.

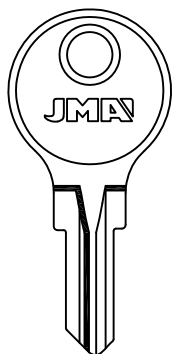

ABU-30

ABU-30D

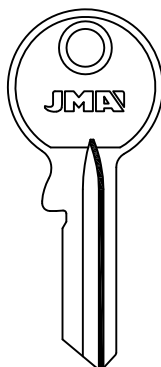

ABU-32D

ANCHOR-IMP

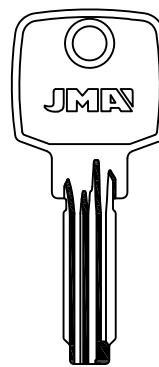

30-40

EC 75

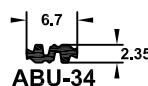

ABU-34

LAT.

## ABUS

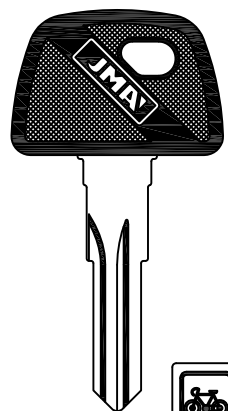

ABU-35.P

BUFFO



X61... 1-331 V61...  
X62... V62...

ABU-36.P

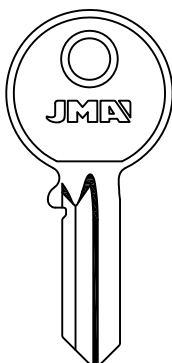

40-50-60

ABU-38D



ABU-39.P

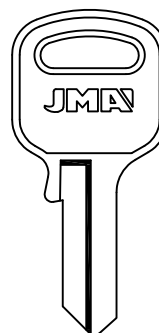

ABU-45

ANCHOR-BURG-GUITTEL



40-45

ABU-40

IMP-ROYAL



PARA-FOR:

ABUS (D)

ABUS

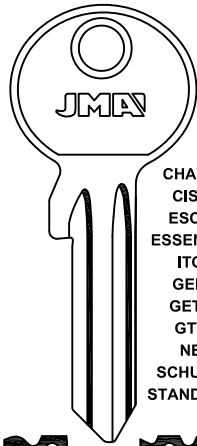

ABU-41

ABU-41D

ABU-68

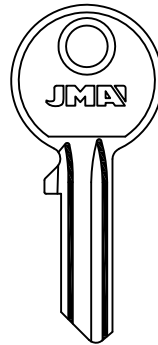

...1-342  
EF...1-724  
B...1-342  
EE...1-724

E....  
ER....  
801-1236

ABU-42

ABU-42D

BUFFO-CISA

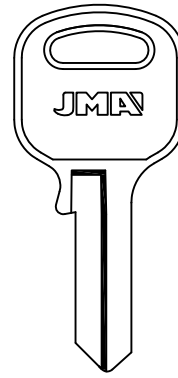

ABU-60

ABU-50

ANCHOR-JMP

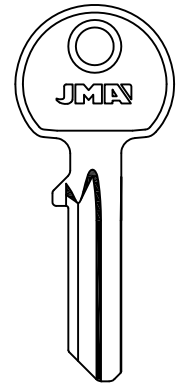

ABU-51D

ABUS

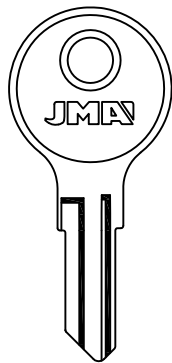

ABU-54

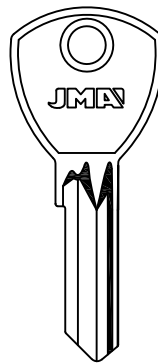

ABU-54D

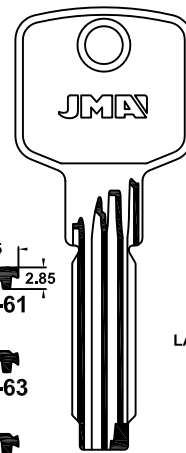

8.25  
2.85  
ABU-61

ABU-63

ABU-66

ABU-81

LAT.

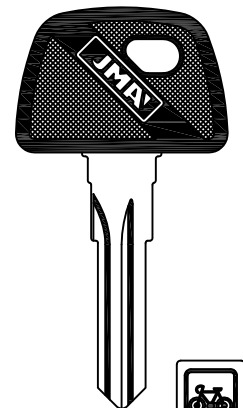

U72  
ABU-64.P

W71  
ABU-65.P

ABUS

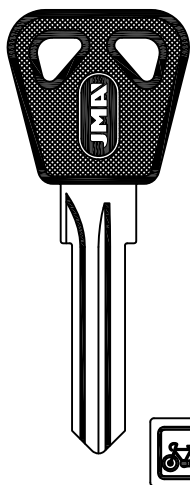

ABU-72.P

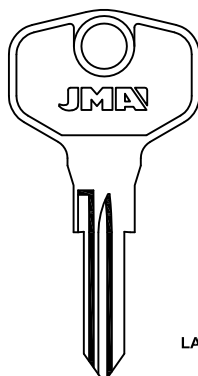

LAT.

ABU-73D

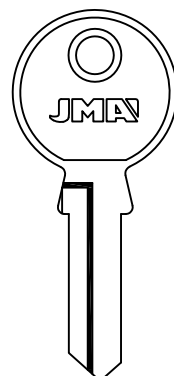

ABU-75D

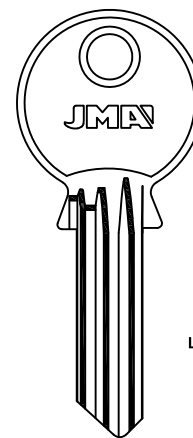

LAT.

004  
ABU-78

GE GE

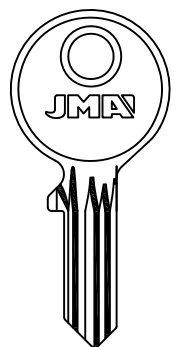

AL  
ABU-79

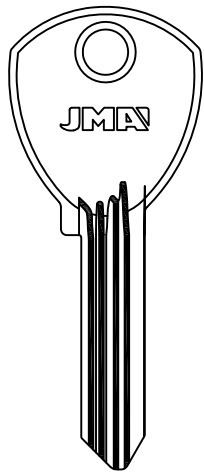
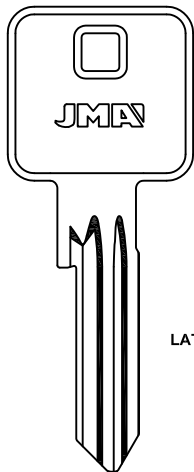

**ABUS**  
ABU-84D  
ABU-86D

LAT.

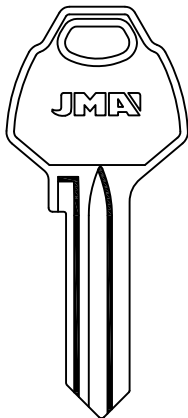
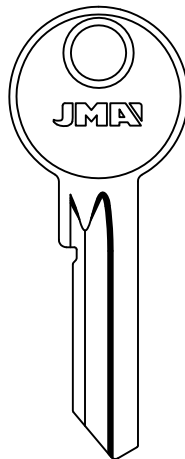
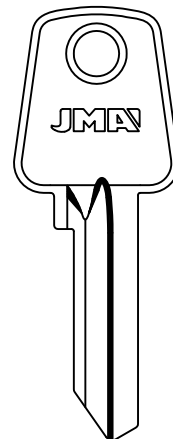
**ADAMSRITE**  
ADS-1D**AEP**  
AEP-1D  
AEP-2D**PARA-FOR:**

ABUS (D)

ADAMSRITE (GB)

AEP (RUS)

AGA (E)

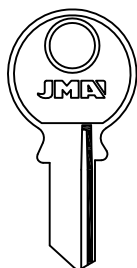
**AGA**

T1

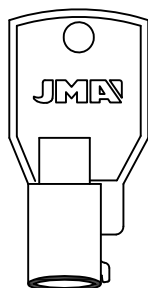
  
AGA-1I  
AGA-1T

LAT.

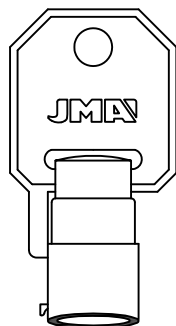
  
AGA-2T

LAT.

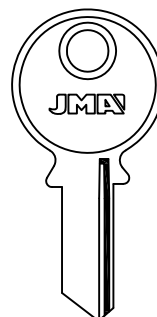
  
AGA-3I

FAC-KEMEN-KIFER-RONEO

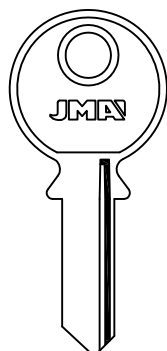
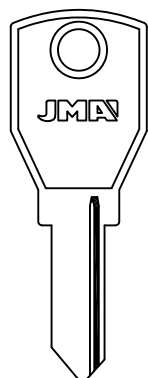
**AGA**  
AGA-4I  
AGA-4D

LAT.

  
AGA-5I  
AGA-6I

LAT.

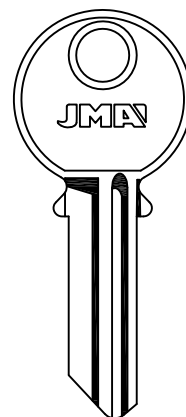
  
AGA-5D  
AGA-6D  
AGA-18I  
AGA-19I  
AGA-18D  
AGA-19D  
AGA-7

MECALUX-SUYOKA

JOVI

**JMA**<sup>®</sup>

Copyright by Alejandro Altuna S.A. 2014



ATENCIÓN: Concerniente a las marcas y denominaciones comerciales ver nota en índice.  
 ATTENTION: Concerning the marks and commercial denominations see note in index.  
 ATTENTION: Concernant les marques et dénominations commerciales voir la note dans l'index.  
 ACHTUNG: Beziehen auf die marke und handelsname sehen sie die notiz im index.

**PARA-FOR:**

AGA (E)

**AGA**

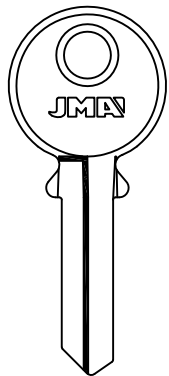

**AGA-8D**

GOYAL-KEMEN

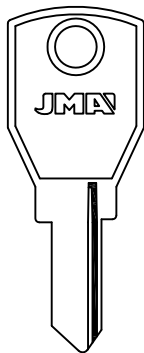

**AGA-9I**



**AGA-23**

ARREGUI-ALFA-GARI  
ORENGO-RUTALCHI-SERRALLER

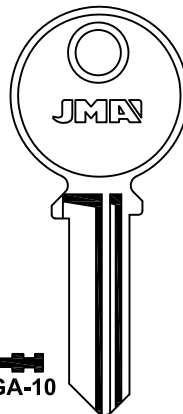

**AGA-10**



**AGA-13I**

**AGA-22**

GARI

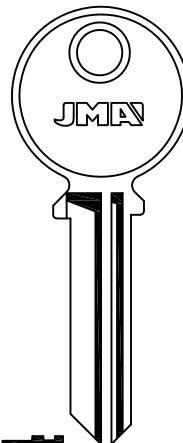

**AGA-11**

**AGA-14D**

GARI

**AGA**

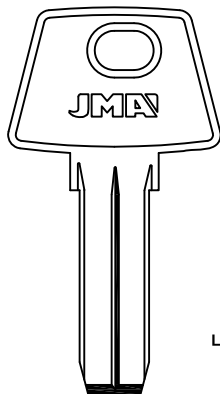

LAT.

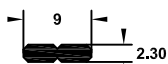

**AGA-12**

COLOMENCA-FB  
SERRALLER-TERCA

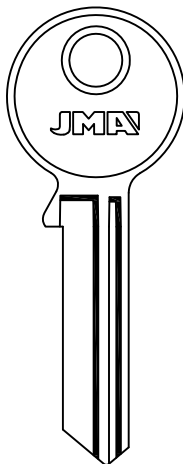

**AGA-15**

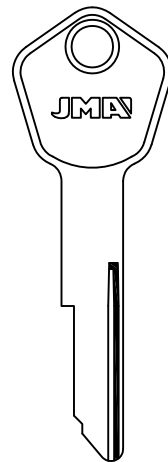

**AGA-16I**

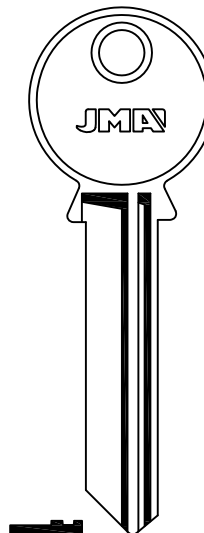

**AGA-20**

SERRALLER

**AGA**

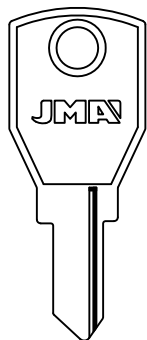

**AGA-24I**

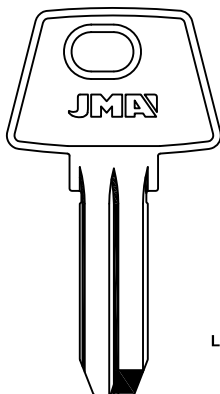

**AGA-24D**

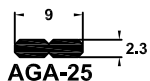

**AGA-25**

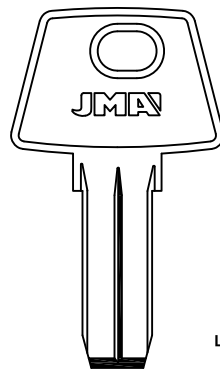

**AGA-29**

CASAS

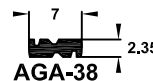
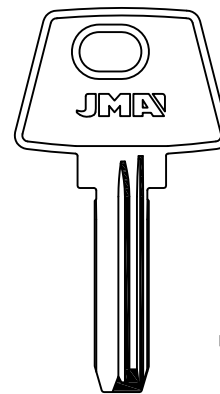

**AGA-38**

**AGA-42**

**AGA-48**



## AGA

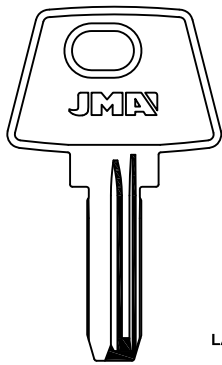

LAT.

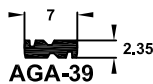

AGA-43 AGA-49

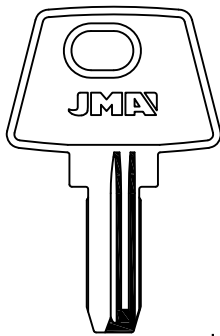

LAT.



AGA-50

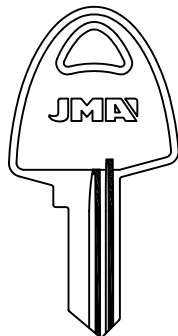

111  
AGA-51

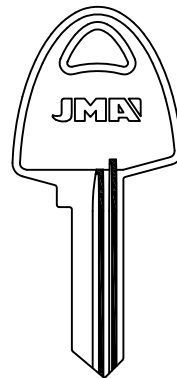

121  
AGA-52

## PARA-FOR:

AGA (E)

AGB (I)

AGC (P)

AGE (J)

## AGB

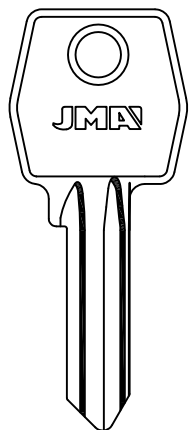

AGB-1 AGB-1D

OIAUS

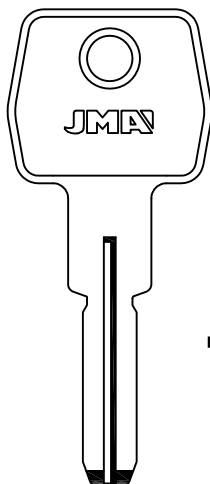

LAT.

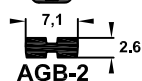

AGB-2

SCUDO

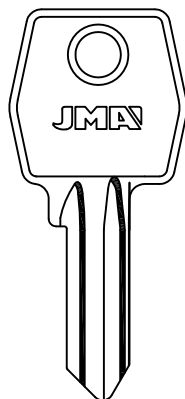

AGB-3 AGB-3D

OIAUS

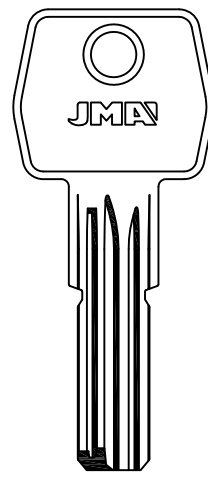

LAT.

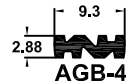

AGB-4

SCUDO 5000

## AGB

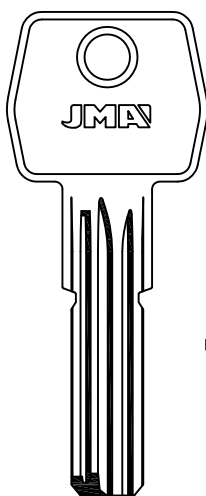

LAT.



AGB-5

SCUDO 5000

## AGC

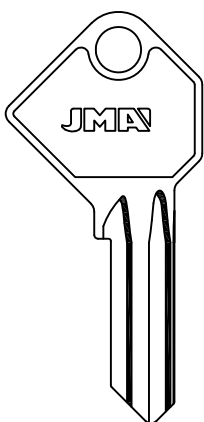

AGD-1

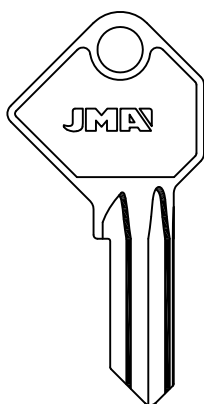

AGD-2

## AGE

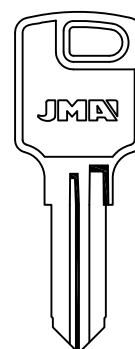

AGE-11





**PARA-FOR:**

- AGE (J)
- AGUIA (P)
- AGUT (E)
- AHRAM (ET)
- AIZPUTE (RUS)
- ALDRIDGE (GB)
- ALE (E)

AGE	AGUIA			
   AGE-2D	   701 AG-1I	   701 AG-1D	   706 AG-6I	   706 AG-6D
	 703 AG-3I	 703 AG-3D	 708 AG-8I	 708 AG-8D
	 704 AG-4I	 704 AG-4D	 709 AG-9I	 709 AG-9D
	 705 AG-5I	 705 AG-5D	 710 AG-10I	 710 AG-10D
			 AG-11	 AG-11D
AGUT	AHRAM	AIZPUTE	ALDRIDGE	
   AGU-1D	   AHR-2	   AIZ-1	   AL-1I	
	 AHR-3	 AIZ-2D		
	 9 2,5			
ALDRIDGE		ALE		
   AL-2	   AL-3	   ALE-1		
 ALE-1D	 ASEC	 ASEC		



# ALFA

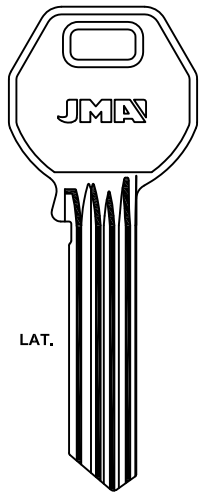

ALF-8	ALF-8D	ALF-15	ALF-22D	ALF-29	ALF-36
ALF-7		ALF-14D	ALF-21	ALF-28	ALF-35
ALF-6		ALF-13D	ALF-20	ALF-27	ALF-34
ALF-5		ALF-12D	ALF-19	ALF-26	ALF-33
ALF-4		ALF-11D	ALF-18	ALF-25	ALF-32D
ALF-3	ALF-10	ALF-10D	ALF-17	ALF-24	ALF-31
ALF-1	ALF-2	ALF-9	ALF-16	ALF-23	ALF-30

GE GE

# PARA-FOR:

- ALFA (S)
- ALIANCA (BR)
- ALPHA (J)
- ALTAY (RUS)
- AMARU (P)

## ALIANCA

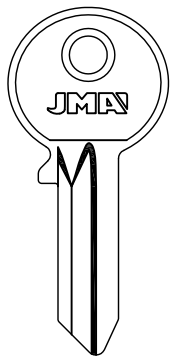

ALC-1D

## ALPHA

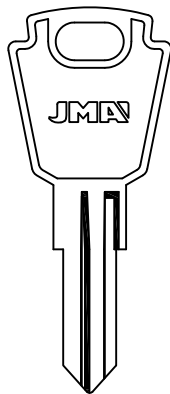

S...301-600

ALP-1I ALP-1D

FEB

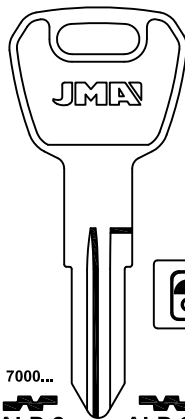

7000...

ALP-2 ALP-2D  
JD-LINCE-MONACOR  
SANY-VISONIC

S...301-600

ALP-6 ALP-6D

FEB

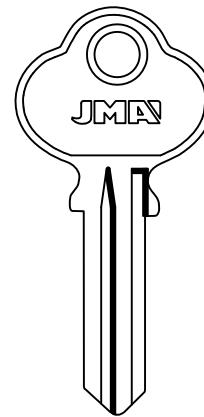

ALP-3

## ALPHA

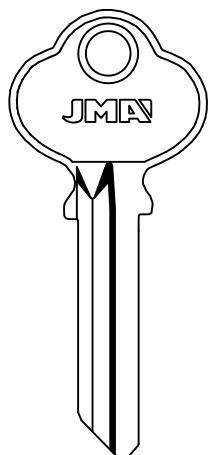

ALP-4D

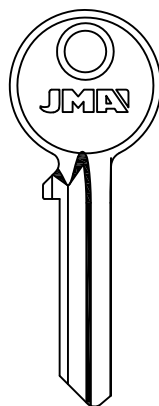

ALP-5D

## ALTAY

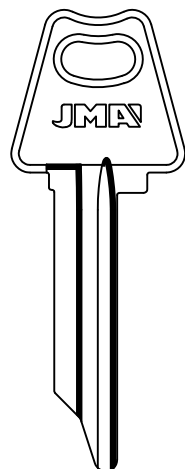

ATA-1 ATA-1D

## AMARU

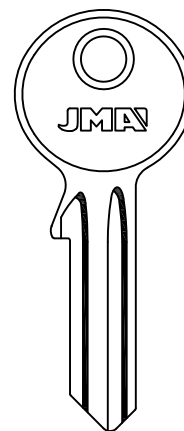

AMA-1 AMA-1D

AL









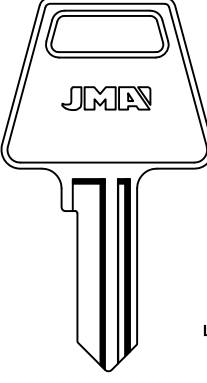
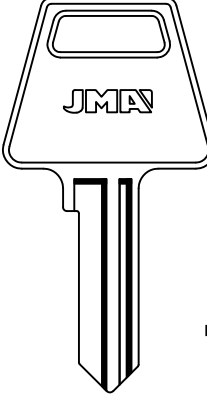
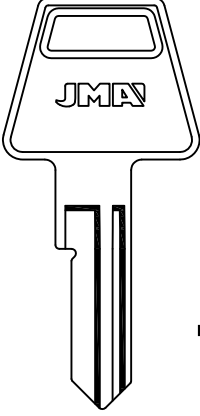
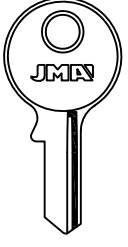

**PARA-FOR:**



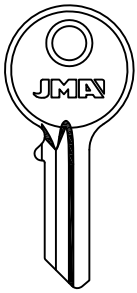
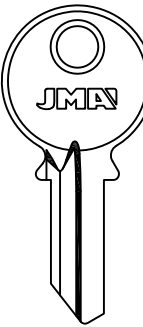
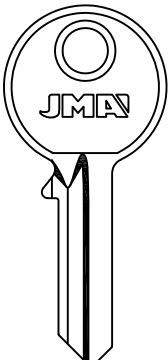
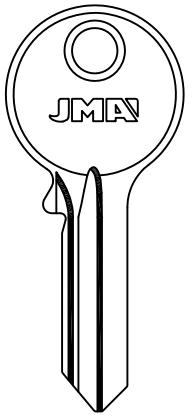

AMERICAN LOCK  
(USA)

AMIG (E)

ANCHOR (S)

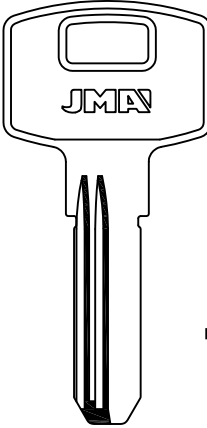
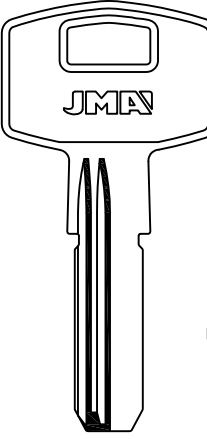
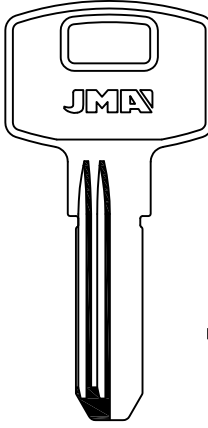
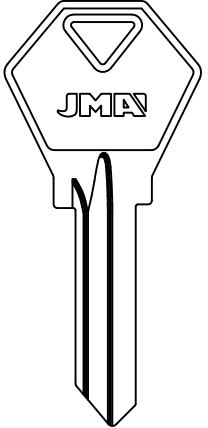
AMERICAN LOCK			AMIG
			
LAT.	LAT.	LAT.	
 AME-1	 AME-2	 AME-4	1-15 / 1-20  AMG-1

AMIG			
			
1-25  AMG-2D	1-30  AMG-3D	1-40  AMG-4D	1-50  AMG-5D

AMIG			ANCHOR
			
LAT.	LAT.	LAT.	
 AMG-8D 5000	 AMG-9D 2500 GMB	 AMG-10D 4900	 ANC-1D ANKERSLOT



**ANCHOR**

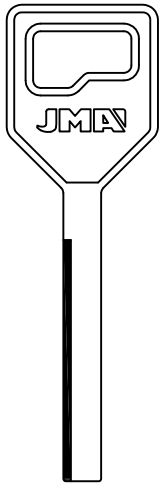

ALP.



**ANC-2**

**ANKER**

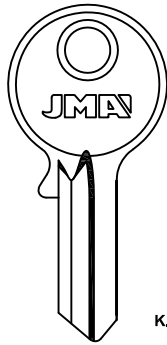

K...111-888  
....  
K...  
1011-7077  
E...  
F...  
B...  
1-2-3-4-5-6-7



**ANK-1**

ANCHOR-LITTO-ODA

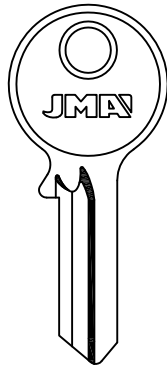

**ANK-2**

ODA

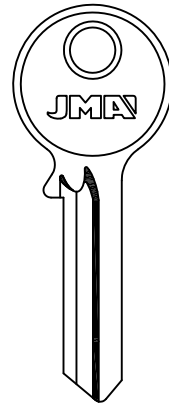

**ANK-3**

ODA

**PARA-FOR:**

- ANCHOR (S)
- ANKER (NL)
- ANTAR (F)
- APEX (RUS)

**ANKER**

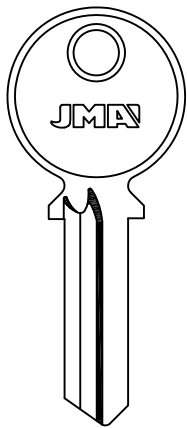

**ANK-4**

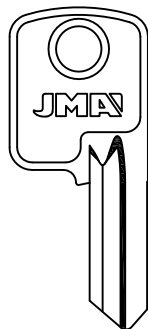

K...111-888  
....  
K...  
1011-7077  
E...  
F...  
B...  
1-2-3-4-5-6-7



**ANK-6**

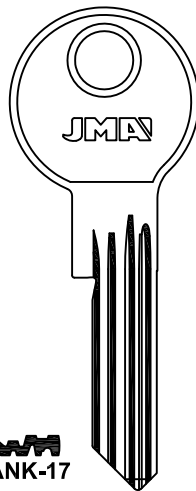

**ANK-17**



**ANK-65**

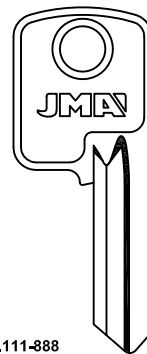

K...111-888  
....  
K...  
1011-7077  
E...  
F...  
B...  
1-2-3-4-5-6-7



**ANK-47D**

**ANTAR**

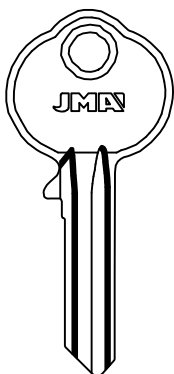

**ANA-1**



**ANA-1D**

VEGA

**APEX**

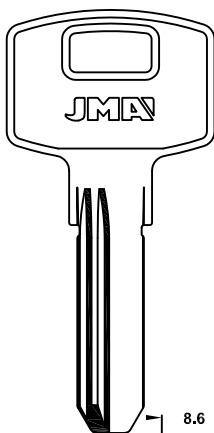

LAT.



**AP-1D**



**AP-3D**

AMIG-BYP-C.V.C.

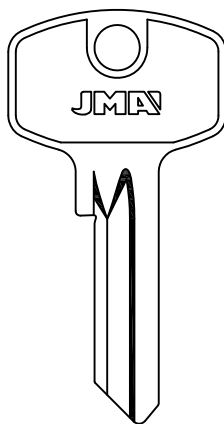

**AP-2D**

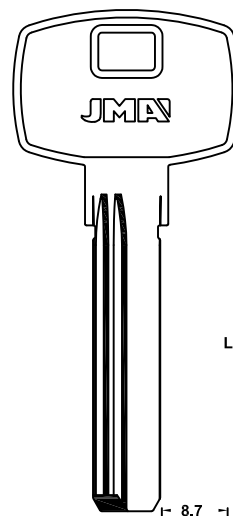

LAT.

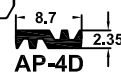











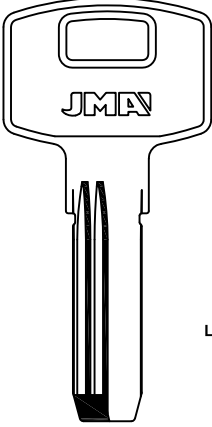
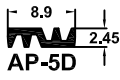
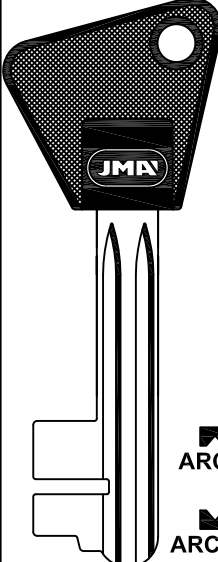

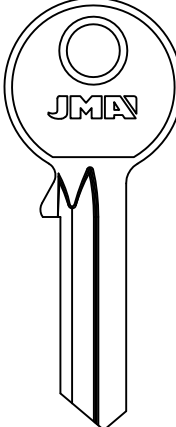

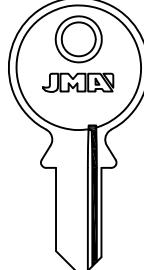

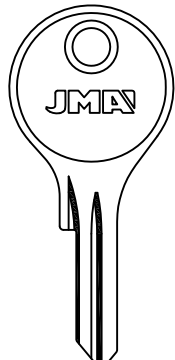

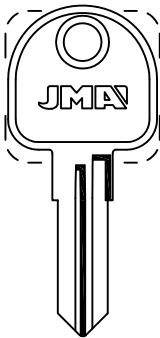

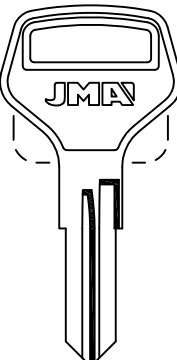

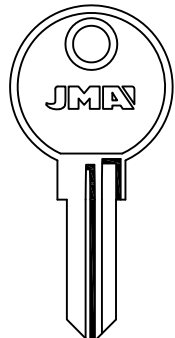

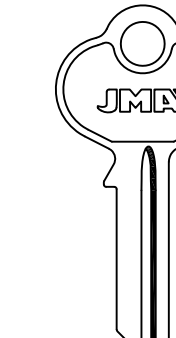



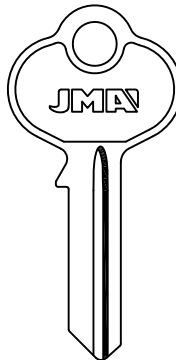

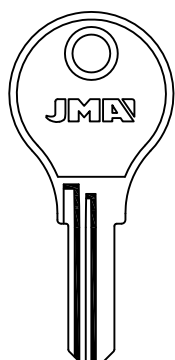

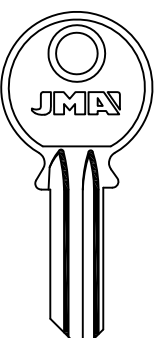

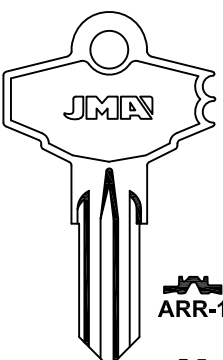

**AP-4D**

FTH

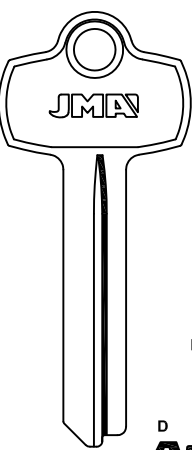

**PARA-FOR:**

- APEX (RUS)
- ARCU (E)
- AREL (GB)
- ARFE (E)
- ARMSTRONG (USA)
- AROUCA (BR)
- ARREGUI (E)
- ARROW (USA)

APEX	ARCU	AREL	ARFE				
 <p>LAT.</p>  <p>AP-5D</p>	 <p>ALP.</p> <p>A</p>  <p>ARC-17.P</p> <p>B</p>  <p>ARC-17D.P</p>	 <p>ARE-1D</p> 	 <p>ARFE-1I</p>  <p>ARFE-1D</p>				
ARFE	ARMSTRONG			AROUCA			
 <p>ARFE-3D</p> 	 <p>ARN-1</p> 	 <p>ARN-2</p> 	 <p>ARN-2D</p> 	 <p>ARN-3</p> 	 <p>ARN-3D</p> 	 <p>ARO-1D</p> 	
ARREGUI		ARROW					
 <p>AR-1D</p> 	 <p>AR-4IP</p> 	 <p>AR-4DP</p> 	 <p>ARR-1</p> 	 <p>ARR-2</p> 	 <p>ARR-3</p> 	 <p>ARR-8</p> 	 <p>LAT.</p> <p>D</p>  <p>ARR-7D</p> <p>C</p>  <p>ARR-9D</p>
INDAUX			DOMINION LOCK-FORT-LG				





**ARSENEVSK**

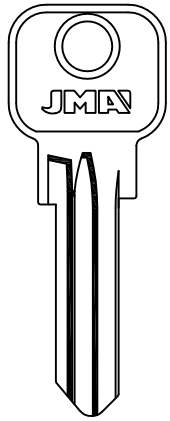

**ARS-1D**

**ASHICO**

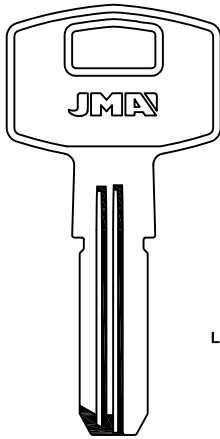

LAT.

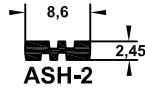

**ASH-2**

**ASIA**

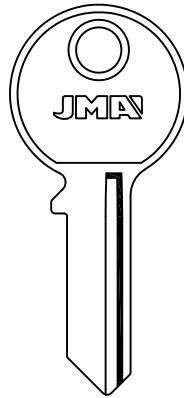

**ASI-1**

CINA

**ASPA**

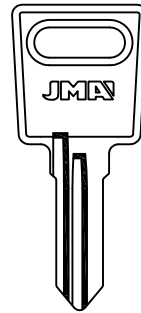

**ASP-1D**

**PARA-FOR:**

- ARSENEVSK (RUS)
- ASHICO (TJ)
- ASIA (RC)
- ASPA (NL)
- ASSA (S)

**ASSA**

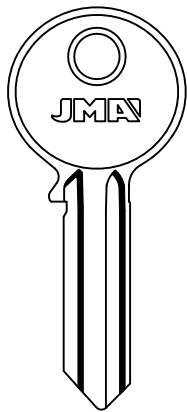

ABC  
0 AL 9

21301  
**AS-3I**

21201  
**AS-3D**

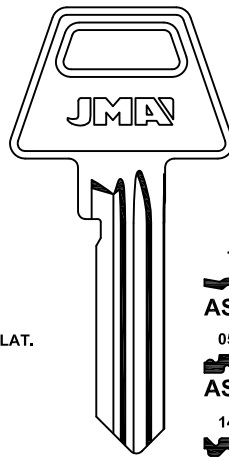

\* LAT.

TL  
**AS-4D**

05-04  
**AS-5D**

14-01  
**AS-6D**

05-13  
**AS-7D**

14-09  
**AS-8D**

14-25  
**AS-9D**

05-05  
**AS-10D**

**AS-11D**

11-14  
**AS-12D**

11-01  
**AS-13D**

11-12  
**AS-14D**

11-32  
**AS-15D**

11-08  
**AS-16D**

05-14  
**AS-18D**

TM  
**AS-25D**

\* **AS-28**

**ASSA**

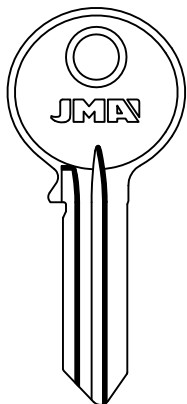

**AS-20D**

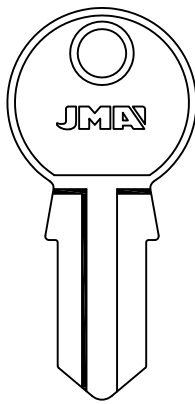

LAT.

**AS-22**

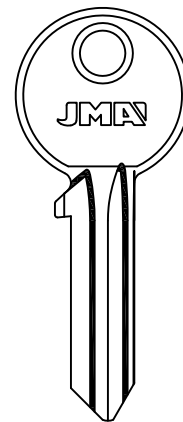

**AS-23**

**AS-23D**

TEKA



**PARA-FOR:**

ASSA (S)

**ASSA**

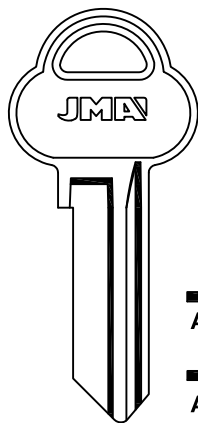

28,4 mm.

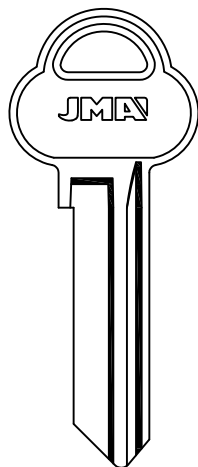

34,5 mm.



**ASSA**

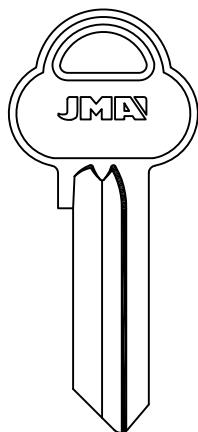

29,7 mm.



**ASSA**

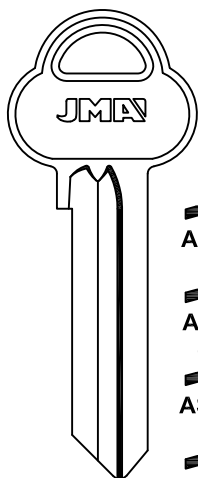

35,7 mm.



# ASSA

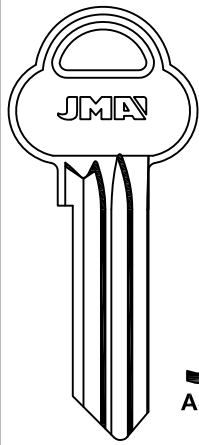

31 mm.

560MG  
AS-MG5  
560KE  
AS-KE5  
560ME  
AS-ME5

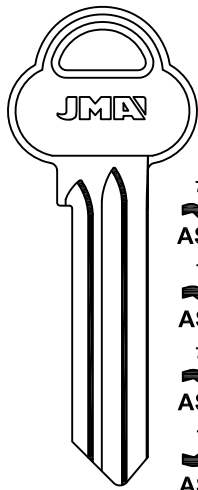

37 mm.

760DD  
AS-DD7  
760KA  
AS-KA7  
760KD  
AS-KD7  
760KF  
AS-KF7  
760LA  
AS-LA7  
760HH  
AS-HH7  
760KE  
AS-KE7  
760KG  
AS-KG7  
760LF  
AS-LF7  
760LE  
AS-LE7

760LD  
AS-LD7

760LG  
AS-LG7

760MA  
AS-MA7

760ME  
AS-ME7

760MD  
AS-MD7

760MG  
AS-MG7

760MF  
AS-MF7

760PF  
AS-PF7

760PG  
AS-PG7

760PA  
AS-PA7

760PB  
AS-PB7

760PH  
AS-PH7

760PR  
AS-PR7

760VV  
AS-VV7

760UU  
AS-UU7

760PN  
AS-PN7

760PT  
AS-PT7

760TT  
AS-TT7

760WW  
AS-WW7

760XX  
AS-XX7

# PARA-FOR:

- ASSA (S)
- AUMON (E)
- AVANGARD (RUS)
- AZBE (E)

## AUMON

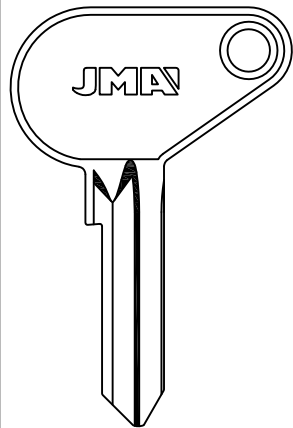

AUM-2D

## AVANGARD

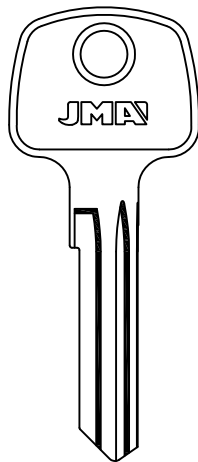

AV-1 AV-1D

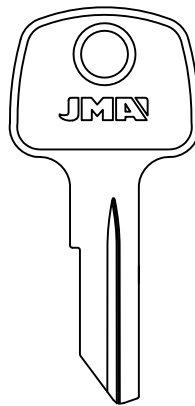

AV-2D

## AZBE

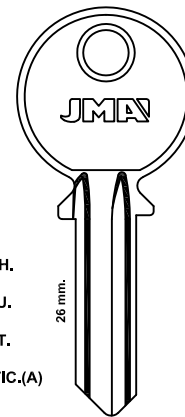

FSH.  
ALU.  
LAT.  
\* MTIC.(A)

26 mm.

AZ-1I AZ-1D \*

ZAIN

## AZBE

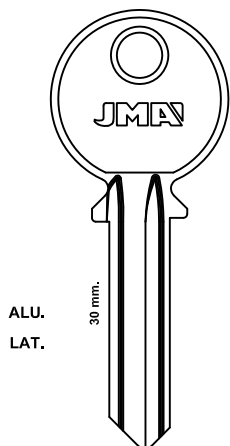

ALU.  
LAT.

30 mm.

AZ-2I AZ-2D

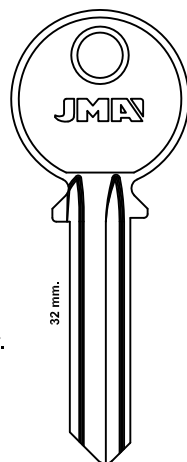

LAT.

32 mm.

AZ-3I AZ-3D

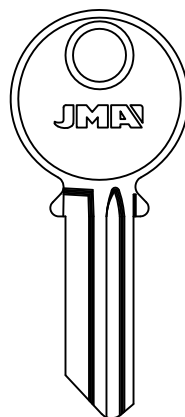

AZ-4

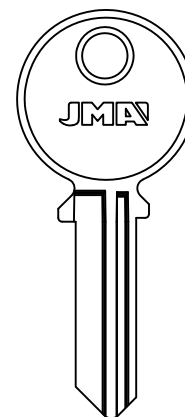

AZ-6



**PARA-FOR:**

AZBE (E)

AZKOYEN (E)

B+D (GB)

**AZBE**

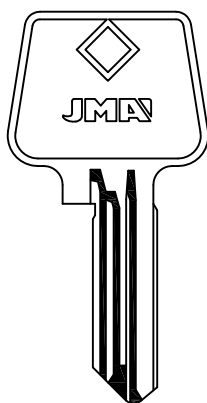

ALP.



AZ-7

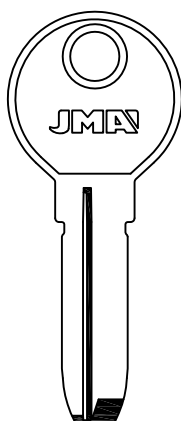

ALP.

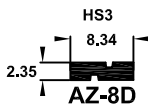

AZ-8D

IFAM

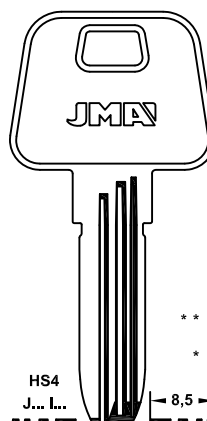

\*\* ALP.

\* LAT.

HS4

J... I...

AZ-9

HS2

2... 3...

AZ-12

\*\*

AZ-12

\*\*

CAVERS-CENTURION-ZAIN



AZ-9D

\*\*↑

HS7

AZ-29

\*

AZ-29

\*

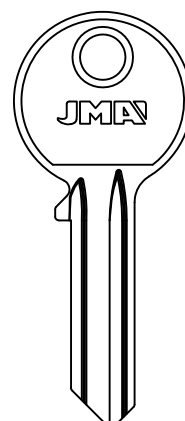

AZ-10

**AZBE**

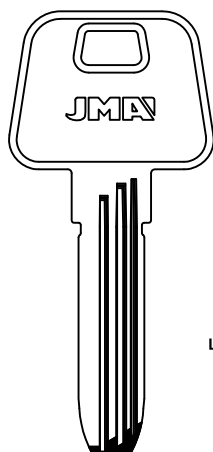

LAT.



AZ-14

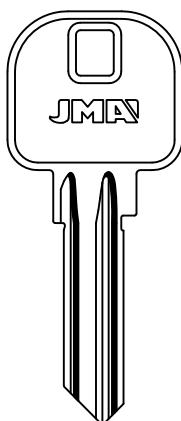

AZ-17



AZ-17D

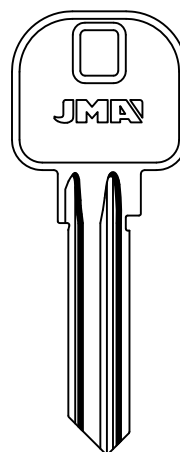

AZ-18



AZ-18D

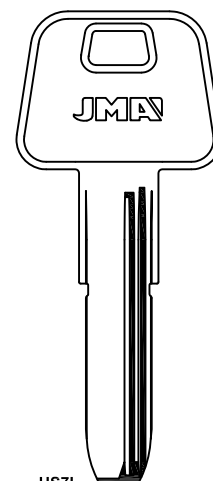

LAT.



AZ-32

**AZBE**

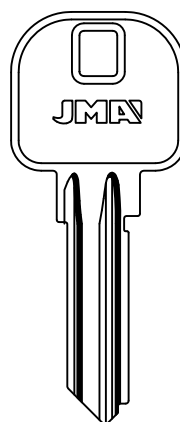

AZ-37



AZ-37D

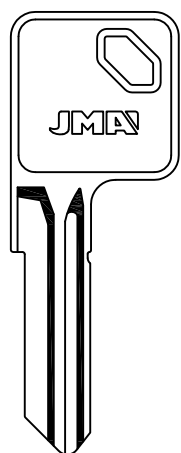

LAT.



SCO-1

SCHLAGE-SCOVILL

**AZKOYEN**

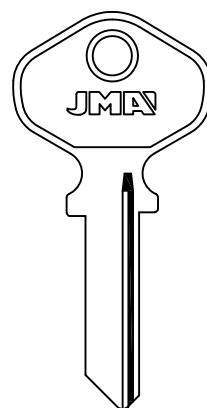

AZKO-11

AGA

**B+D**

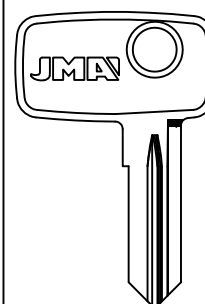

BD-1

ROLL A DOOR



**BAB**

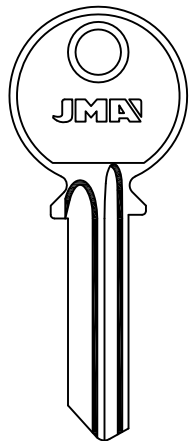

**BAB-11**

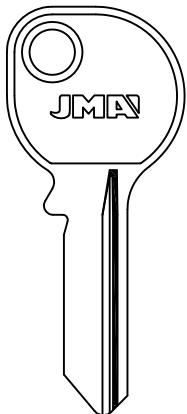

**BAB-21**

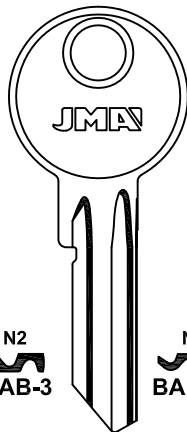

N2  
**BAB-3**

N1  
**BAB-3D**

**BAB-11**

**BAB-12D**

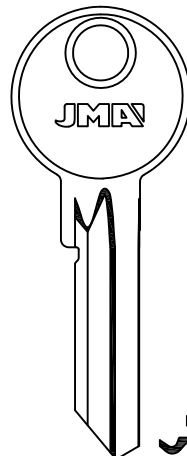

SN2  
**BAB-5**

N1  
**BAB-4D**

SN1  
**BAB-5D**

**PARA-FOR:**

BAB (D)

BAGEM (E)

**BAB**

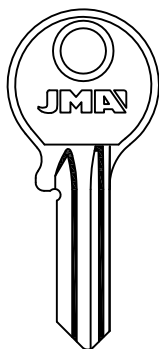

**BAB-6**

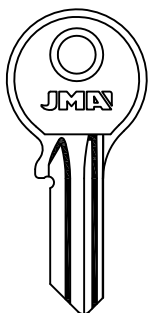

**BAB-7**

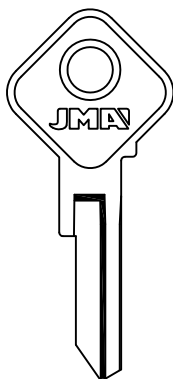

**BAB-8D**

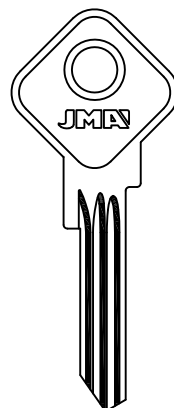

**BAB-9D**

**BAB**

**BAGEM**

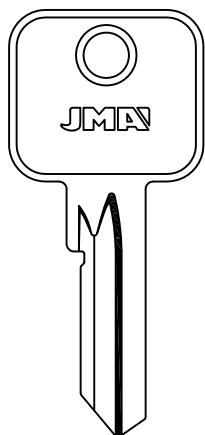

**BAB-14D**

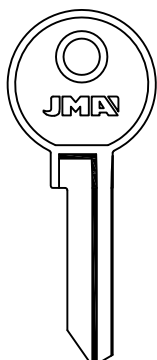

LAT.

**BAB-17D**

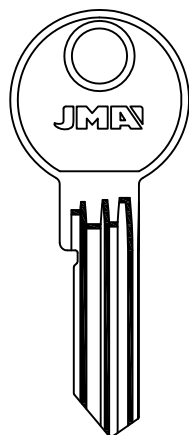

**BAB-19**

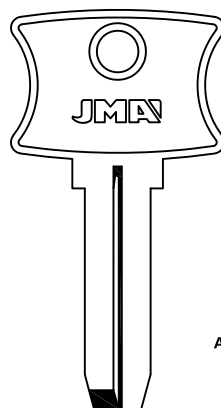

ALP.



8,7  
**BAG-1**  
2,3



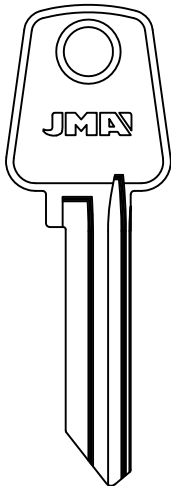
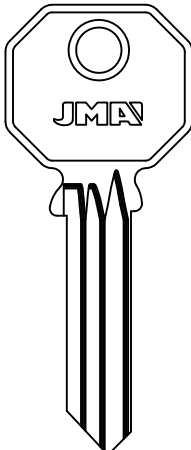
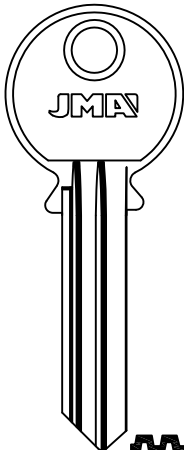
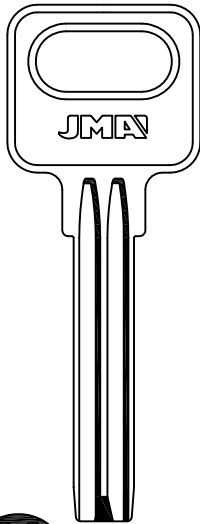

**PARA-FOR:**

- BALTIKA (RUS)
- BANHAM (GB)
- BAODEAN (TJ)
- BARCZ (PL)
- BARIER (RUS)
- BASCO (USA)
- BASI (D)
- BASTA (IRL)

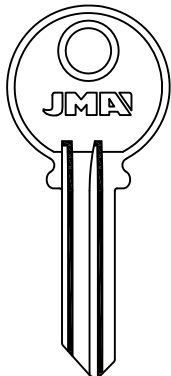
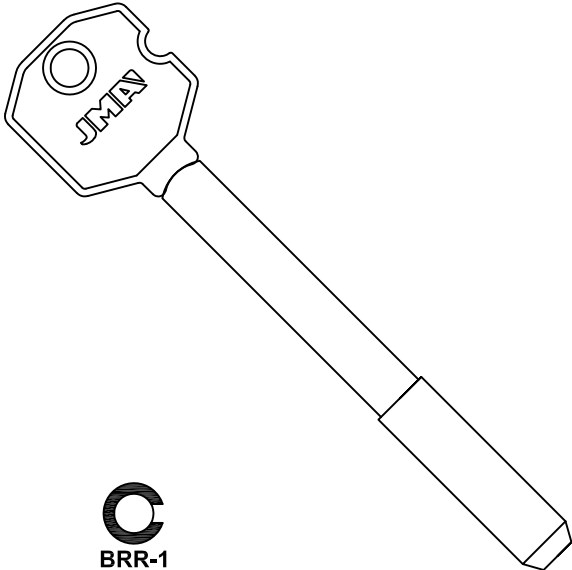
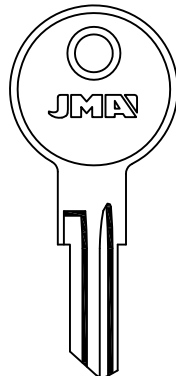
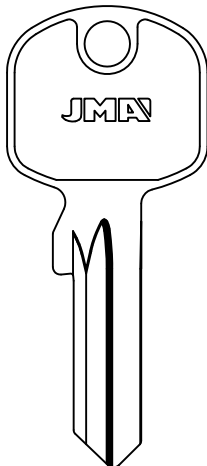
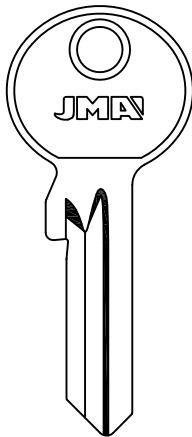
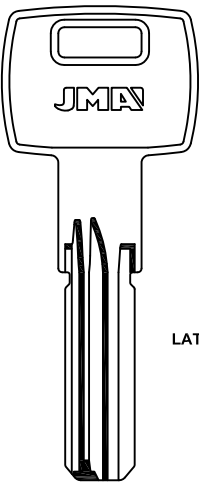
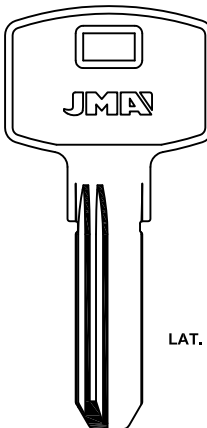
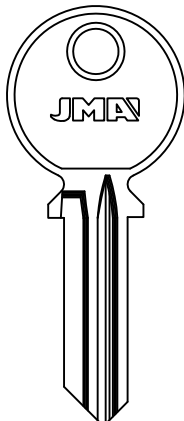
BALTIKA	BANHAM		BAODEAN
 <p><b>BLT-1</b></p>	 <p><b>BAN-1I</b></p>	 <p><b>BAN-1D</b></p>	 <p><b>BDA-1</b></p> <p>LAT.</p>
		 <p><b>BAN-2D</b></p>	
		 <p><b>BAN-3D</b></p>	
			<p>BTV</p>
BARCZ	BARIER		BASCO
 <p><b>BCZ-1</b></p> <p><b>BCZ-2</b></p>	 <p><b>BRR-1</b></p>		 <p><b>BAS-4</b></p> <p>AMERICAN M.-B&amp;S-CHICAGO C. ELMO-HERSEE E.-ILLINOIS-YALE</p>
BASI			BASTA
 <p><b>BAI-1D</b></p> <p>1 AL 9</p>	 <p><b>BAI-5D</b></p>	 <p><b>BAI-8D</b></p> <p>GEVY-SATURN</p>	 <p><b>BAI-9D</b></p> <p>TOVER</p> <p>CX 8,6 2,5</p>
			 <p><b>BAST-1I</b></p>



BASTA			BATU
 BAST-2D	 BAST-3D	 BAST-4D.P	 BATU-11
EURO LOCKS			

**PARA-FOR:**

- BASTA (IRL)
- BATU (E)
- BEST (USA)
- BETA (I)
- BEY (TR)
- BIBERING (D)

BEST		BETA	
	<p>Q BES-12D</p> <p>R BES-13D</p> <p>L BES-10D</p> <p>M BES-11D</p> <p>J BES-8D</p> <p>K BES-9D</p> <p>TB BES-17D</p> <p>G BES-6D</p> <p>H BES-7D</p> <p>F BES-16D</p> <p>DD BES-4D</p> <p>E BES-5D</p> <p>FM BES-15D</p> <p>A BES-1D</p> <p>C BES-2D</p> <p>D BES-3D</p> <p>B BES-14D</p>		
FALCON		 BE-1	 BE-4I
			 BE-4D

BETA	BEY		BIBERING
 BE-5I	 BE-5D	 BEY-1D	 BEY-2D
PICARD		TAS-TÜRSCHLOSS	



**PARA-FOR:**











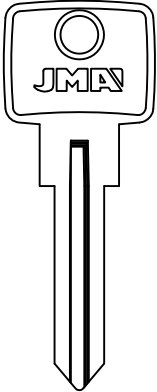
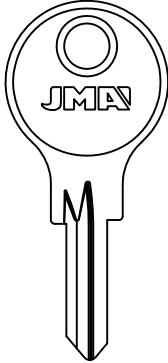
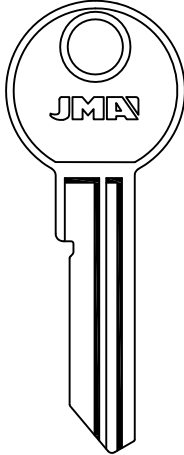
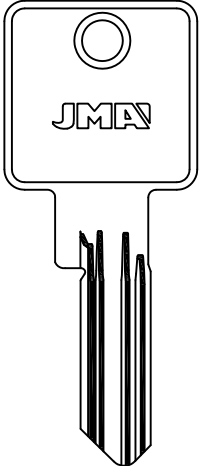





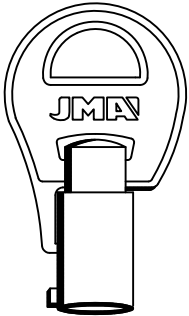
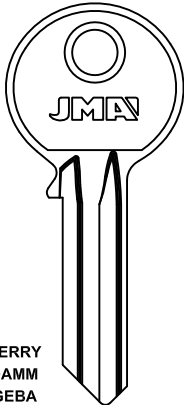
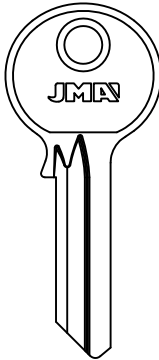
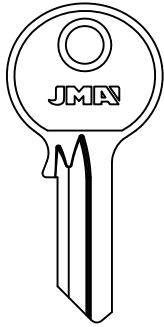





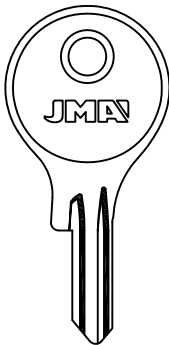
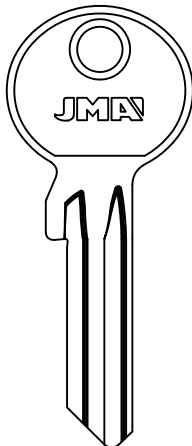
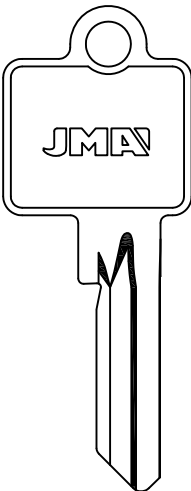



BIBERING (D)

BIELLE (I)

BIFFAR (D)

BILMA (E)

BKS (E)

BIBERING		BIELLE		BIFFAR	
					
 BI-2	 BI-3D	 BIE-1		  BIF-1	
		FASEM-OMIV-P.C.		FICHET-TOK	
BILMA			BKS		
					
	LAT.	BERRY DAMM GEBA HOHRMANN PZ YALE	ALU.		
 BIL-1T		 BK-1I	 BK-1D	 BK-2D	 R 101-105 BK-3D
			YALE		YALE-WECO
BKS					
				 BK-21/1	
				 BK-21/2	
				 BK-21/7	
				 BK-21/9	
				 BK-21/14	
 BK-4	 BK-4D			 BK-21/17	
 BK-5I	 BK-5D	 BK-6I	 BK-6D	 BK-7D	 BK-21/19
	METEOR-YALE				



## BKS

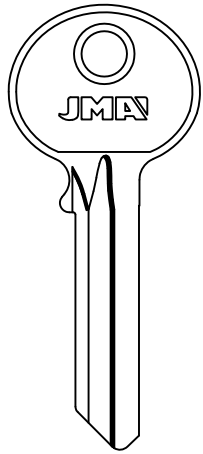

NA  
BK-8D

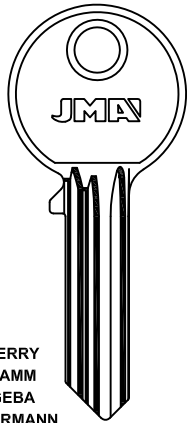

BERRY  
DAMM  
GEBÄ  
HOHRMANN  
PZ  
YALE

BK-9  
SERIE O

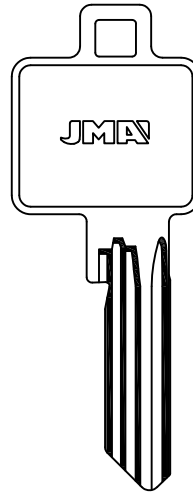

BK-14  
PZ-YALE

PARA-FOR:

BKS (D)

## BKS

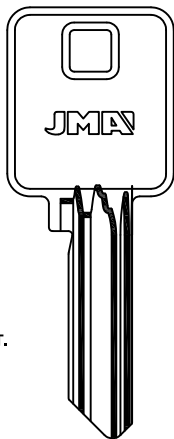

\* LAT.

* BK-16/7	* BK-16/17	
* BK-16/5	* BK-16/16	BK-16/30
* BK-16/4	* BK-16/15	* BK-16/23
* BK-16/3	* BK-16/14	* BK-16/21
* BK-16/2	* BK-16/13	* BK-16/20
* BK-16/1	* BK-16/10	* BK-16/19
* BK-16/0	* BK-16/9	* BK-16/18

SERIE 2000

## BKS

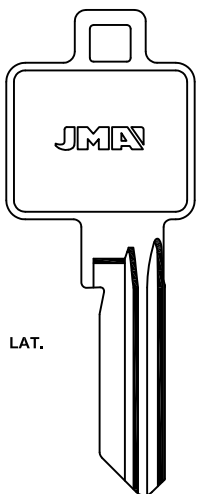

LAT.

BK-17/7PZ			BK-17/7	
BK-17/6PZ			BK-17/6	
BK-17/5PZ			BK-17/5	
BK-17/4PZ	BK-17D/4PZ		BK-17/4	
	BK-17D/3PZ		BK-17/3	
BK-17/2PZ	BK-17D/2PZ	BK-17/9PZ	BK-17/2	BK-17/9
BK-17/1PZ	BK-17D/1PZ	BK-17/8PZ	BK-17/1	BK-17/8

PZ-YALE

SERIE O

**JMA**®

Copyright by Alejandro Altuna S.A. 2014



ATENCIÓN: Concerniente a las marcas y denominaciones comerciales ver nota en índice.  
 ATTENTION: Concerning the marks and commercial denominations see note in index.  
 ATTENTION: Concernant les marques et dénominations commerciales voir la note dans l'index.  
 ACHTUNG: Beziehen auf die marke und handelsname sehen sie die notiz im index.

**PARA-FOR:**

- BKS (D)
- BMB (D)
- BODA (SF)

**BKS**

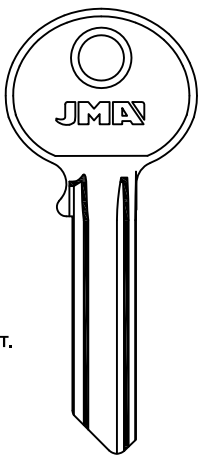

LAT.

B7 BK-18/7	B15 BK-18/15	B23 BK-18/23	B30 BK-18/30	
B6 BK-18/6	B14 BK-18/14	B22 BK-18/22	B29 BK-18/29	
B5 BK-18/5	B13 BK-18/13	B21 BK-18/21	B28 BK-18/28	B35 BK-18/35
B4 BK-18/4	B12 BK-18/12	B20 BK-18/20	B27 BK-18/27	B34 BK-18/34
B3 BK-18/3	B11 BK-18/11	B18 BK-18/18	B26 BK-18/26	B33 BK-18/33
B2 BK-18/2	B10 BK-18/10	B17 BK-18/17	B25 BK-18/25	B32 BK-18/32
B1 BK-18/1	B9 BK-18/9	B16 BK-18/16	B24 BK-18/24	B31 BK-18/31

SERIE 1000



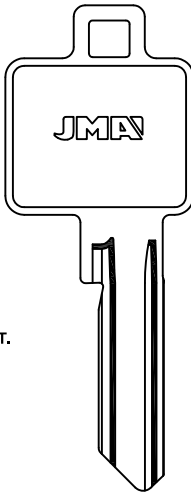





**BKS**

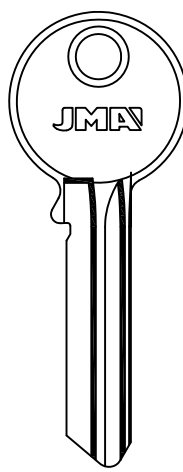

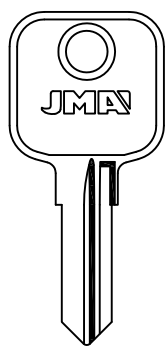
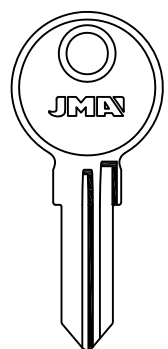
LAT.

B8 BK-19/8	B16 BK-19/16	B27 BK-19/27	
B7 BK-19/7	B15 BK-19/15	B26 BK-19/26	
B6 BK-19/6	B14 BK-19/14	B25 BK-19/25	
B5 BK-19/5	B13 BK-19/13	B23 BK-19/23	
B4 BK-19/4	B12 BK-19/12	B21 BK-19/21	
B2 BK-19/2	B11 BK-19/11	B20 BK-19/20	B32 BK-19/32
B1 BK-19/1	B10 BK-19/10	B19 BK-19/19	B31 BK-19/31

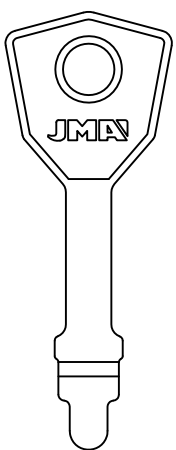
SERIE 1000

BKS	BMB	BODA
  <b>BK-20</b>	 <p>LAT.</p>  <p>A</p>  <b>BMB-1</b> <p>M</p>  <b>BMB-3D</b> <p>A...401-600</p>  <b>BMB-2</b>	  <b>BOD-1</b>





## BOMORO

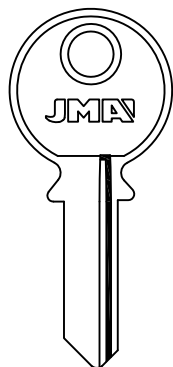
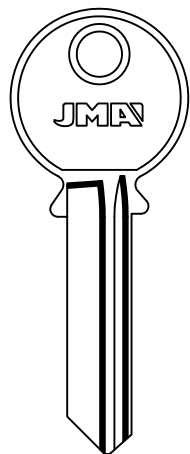

LAPORTE-PRESTA

## BÖRKEY

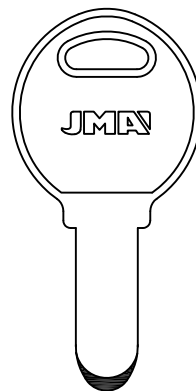
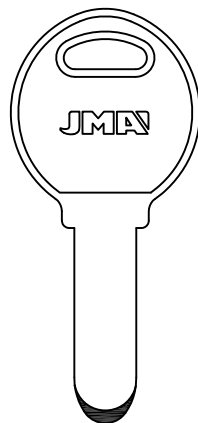

LAT.

LAT.

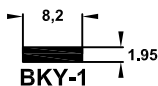

PHILLIPS-YALTRES

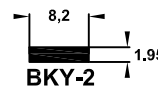

PHILLIPS-YALTRES

## BOULTON & P.

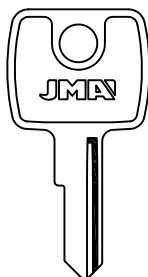

RST

## BRABANTIA

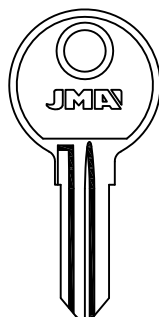

BRA-2

## BRAS

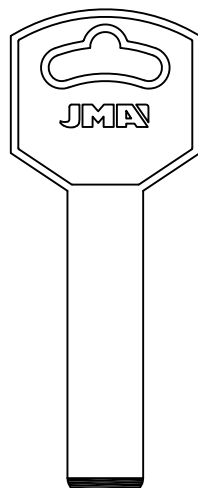

ALP.



BRAS-1

## BRASIL

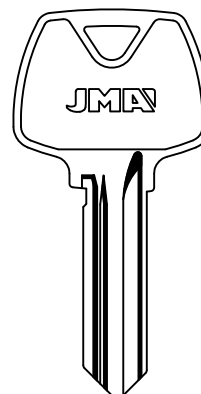

BRS-1

## BRICARD

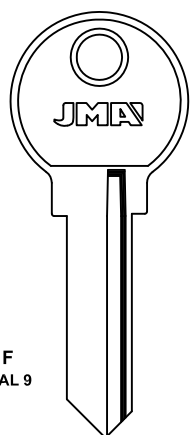

F  
0 AL 9

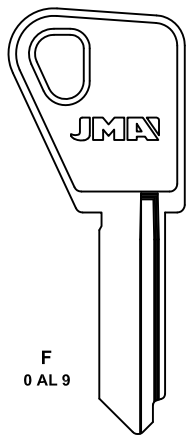

F  
0 AL 9

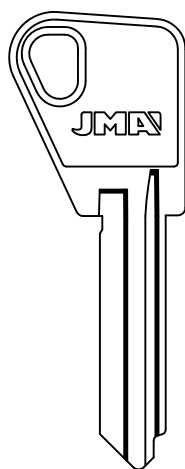

F  
0 AL 9



STREMLER

## PARA-FOR:

BOMORO (D)

BÖRKEY (D)

BOULTON & PAUL  
(GB)

BRABANTIA (E)

BRAS (E)

BRASIL (BR)

BRICARD (F)

**JMA**<sup>®</sup>

Copyright by Alejandro Altuna S.A. 2014



ATENCIÓN: Concerniente a las marcas y denominaciones comerciales ver nota en índice.

ATTENTION: Concerning the marks and commercial denominations see note in index.

ATTENTION: Concernant les marques et dénominations commerciales voir la note dans l'index.

ACHTUNG: Beziehen auf die marke und handelsname sehen sie die notiz im index.

**PARA-FOR:**

BRICARD (F)

BRUMME (D)

BSS (SCG)

**BRICARD**

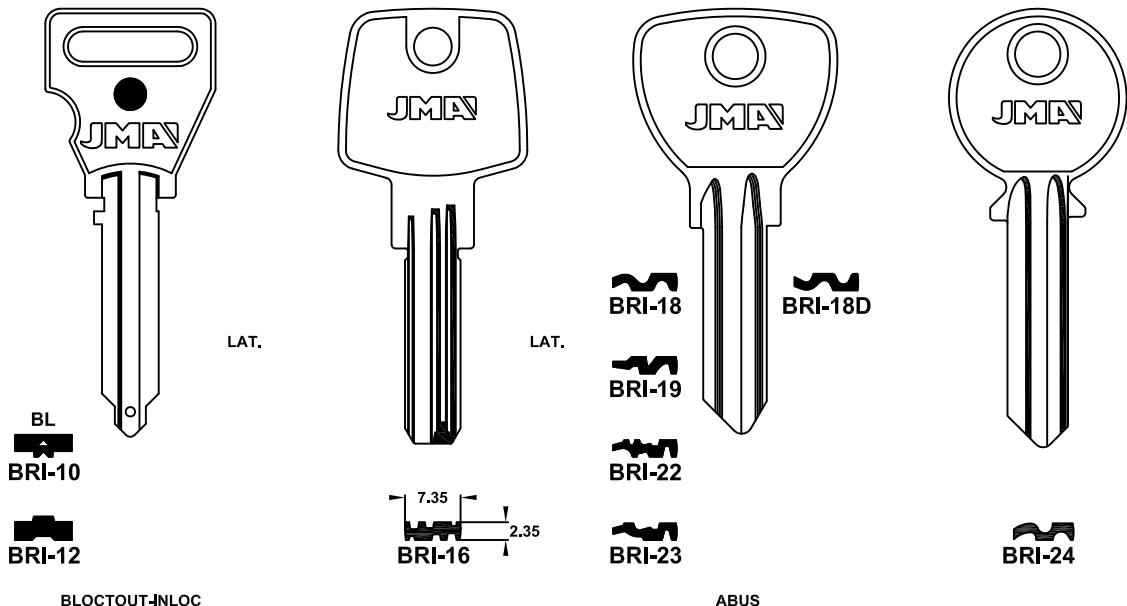

**BRICARD**

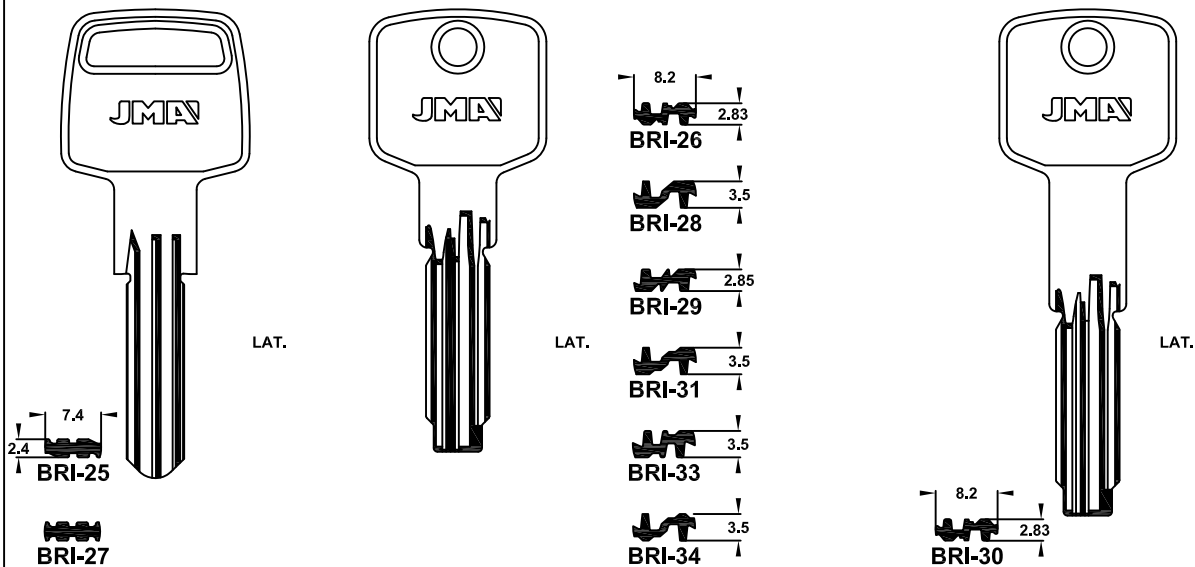

**BRICARD**

**BRUMME**

**BSS**

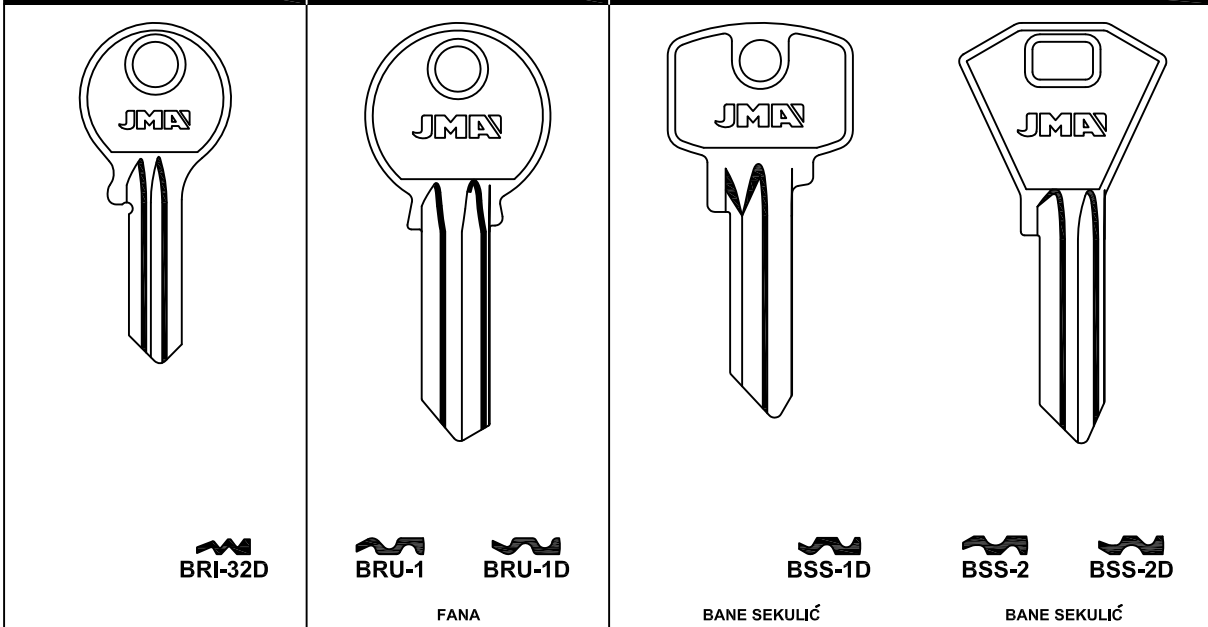

**BSS**

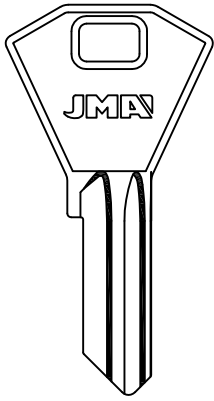

**BSS-3**

BANE SEKULIĆ

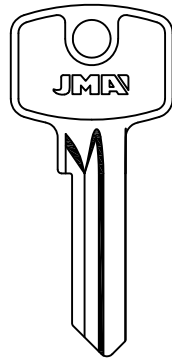

**BSS-4D**

BANE SEKULIĆ

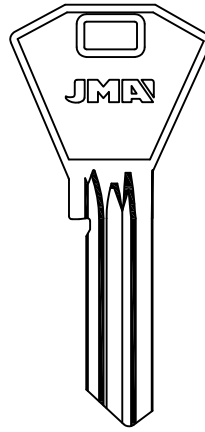

**BSS-5D**

BANE SEKULIĆ-GE GE

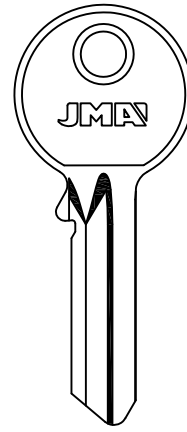

**BSS-6D**

BANE SEKULIĆ

LAT.

**PARA-FOR:**

BSS (SCG)

BTV (E)

BUGA (D)

BULAT (RUS)

**BTV**

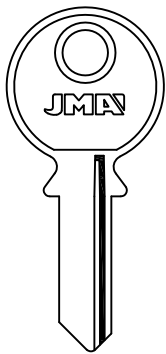

**BTV-1I**

**BTV-1D**

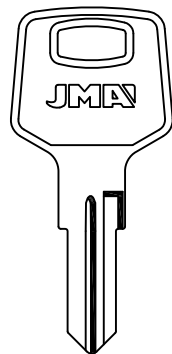

**BTV-2I**

**BTV-2D**

SADV

**BTV-3**

**BUGA**

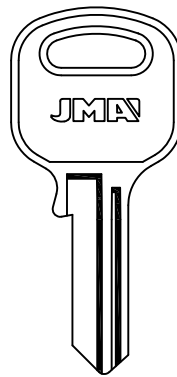

**BAI-6**

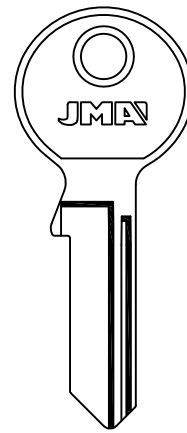

**BAI-7**

**BULAT**

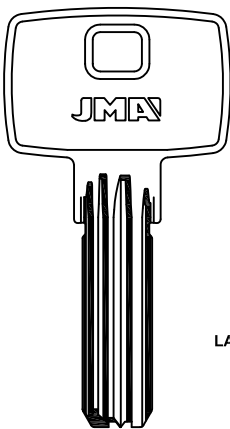

LAT.

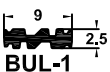

**BUL-1**

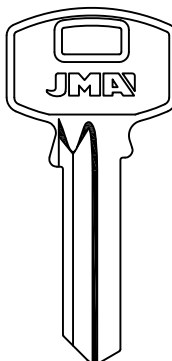

**BUL-2D**

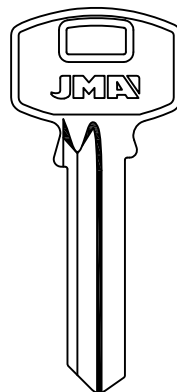

**BUL-3D**

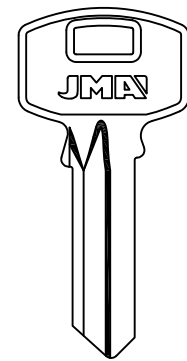

**BUL-4D**



**PARA-FOR:**

BULAT (RUS)

BURG (D)

BULAT		BURG	
		  1/91/9... 0 AL 6	  1/91/9... 0 AL 6
BUL-5D	BUL-7D	BUR-11 BUR-1D	BUR-27D BUR-2D
			MELSMETALL

BURG			
BUR-3 BUR-3D	BUR-4 BUR-4D	BUR-5 BUR-5D	BUR-6
			MELSMETALL

BURG			
	  1/91/9... 0 AL 6	 ATL-BURGWACHTER-BUVA-HEWY DURABLE-HOPPE-RITTAL-WSM	 CIBOX-HOPPE-KIND-ROTO
BUR-7	BUR-8D	BUR-9 BUR-9D	BUR-10 BUR-10D



## BURG

PARA-FOR:

BURG (D)

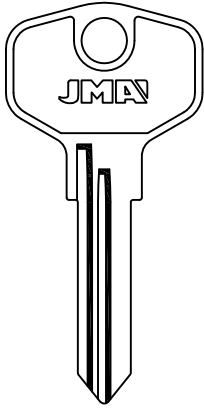

 BUR-11D

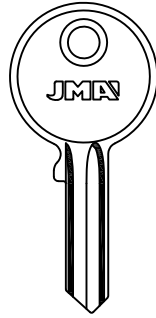

 BUR-12

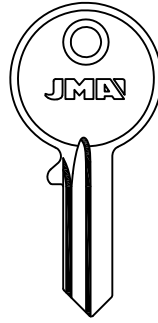

 BUR-13D

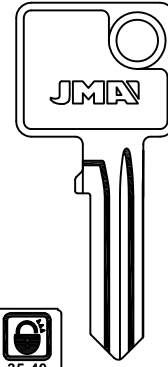

 BUR-14

 BUR-14D

222 C40

 BUR-19D

ANKE-BURG WACHTER

DESAL

ITEM-RITTAL

## BURG

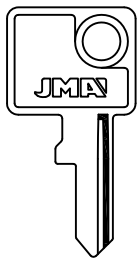

 BUR-15

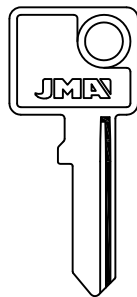

 BUR-16

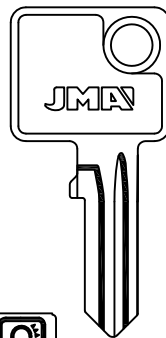

 BUR-17

 BUR-17D

222 C30

 BUR-20D

 BUR-18D

## BURG

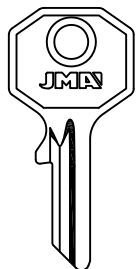

 BUR-21D

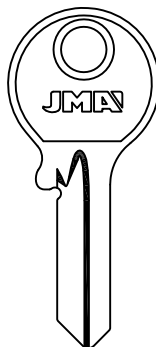

 BUR-22D

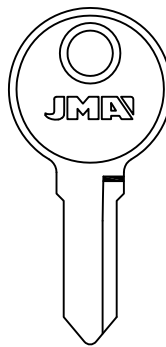

 BUR-24

 BUR-24D

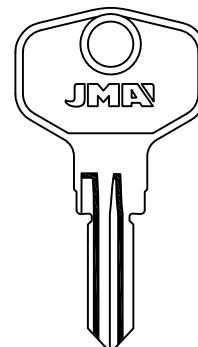

 BUR-25D

**JMA**<sup>®</sup>

Copyright by Alejandro Altuna S.A. 2014



ATENCIÓN: Concerniente a las marcas y denominaciones comerciales ver nota en índice.

ATTENTION: Concerning the marks and commercial denominations see note in index.

ATTENTION: Concernant les marques et dénominations commerciales voir la note dans l'index.

ACHTUNG: Beziehen auf die marke und handelsname sehen sie die notiz im index.

**PARA-FOR:**

BURG (D)

BUS (D)

BUVA (D)

CAB (I)

CAM LOCK  
(USA)

CARTERO (E)

**BURG**

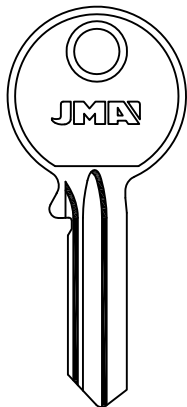

LAT.



**BUR-26D**

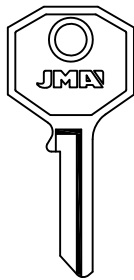

LAT.

**BUR-28**

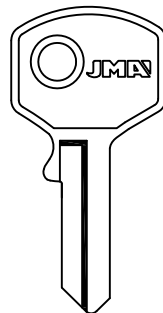

**BUR-29**

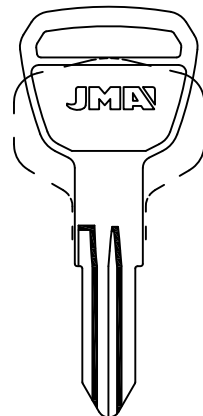

**BUR-29D**

ZBK 70/74  
ZS 85/86

**BUR-31D**

**BURG**

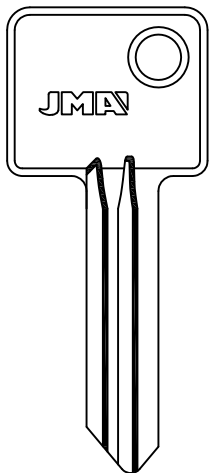

**BUR-32D**

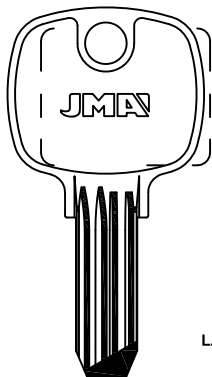

LAT.

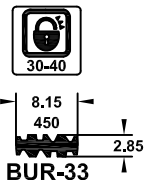

**BUR-33**

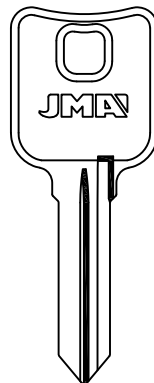

**BUR-34**

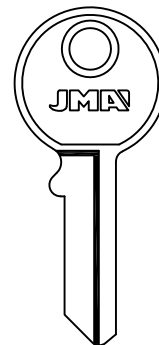

**BUS-1**

KROST

**BUS**

**BUVA**

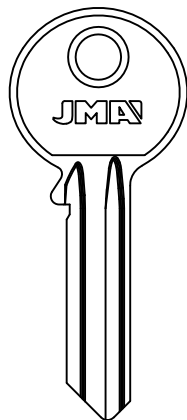

**BUVA-1**

**BUVA-1D**

**CAB**

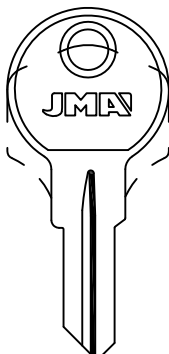

LAT.

**CAB-1D**

**CAM LOCK**

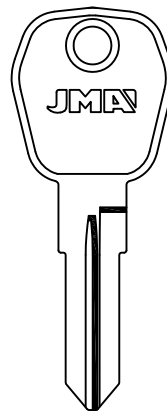

LAT.

**CML-1**

**CARTERO**

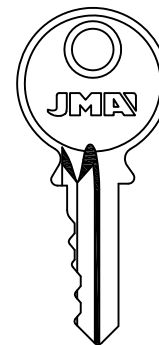

**C**

AGA-FAC-ST5





**CARTERO**

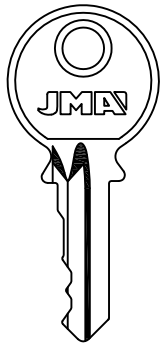

ABSA

**CAS CISMA**

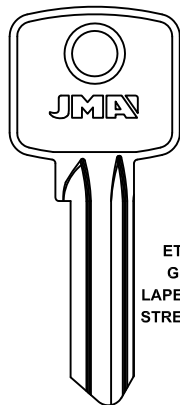

ETNA  
GSA  
LAPERCHE  
STREMLER

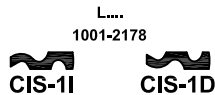

L....  
1001-2178

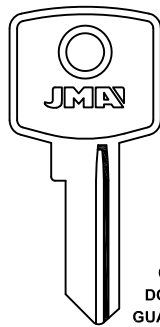

BY  
CAB  
DOMUS  
GUARDIAN  
MST  
SISO  
STIQAM  
TESTA



CIS-2



CIS-3

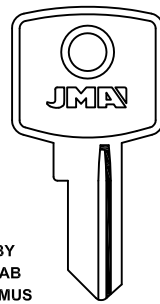

BY  
CAB  
DOMUS  
GUARDIAN  
MST  
SISO  
STIQAM  
TESTA



CIS-4



CIS-5

LAT.

**CAS CISMA**

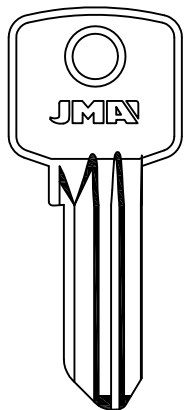

LAT.



KP2  
CIS-6D



CIS-7D

**CASH BOX**

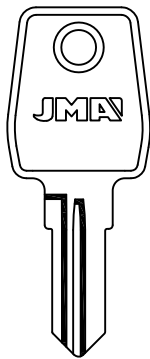

CSB-1D



0-1-2  
CSB-2D

ARREGUI-FAC-JOMA

**CAVERS**

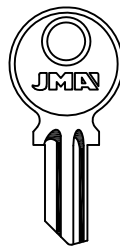

CA-1I

CITY

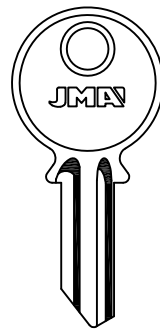

CA-2I



CA-10I

CITY-ZENICA

**CAVERS**

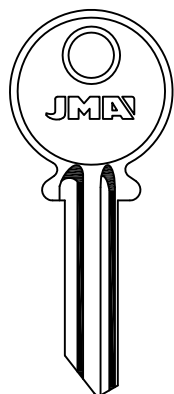

CA-3I



CA-9I

CITY-KVR

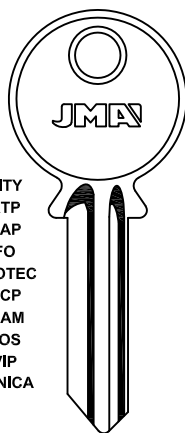

CITY  
ATP  
CAP  
FO  
PROTEC  
QCP  
SIAM  
SOS  
VIP  
ZENICA



CA-4I



CA-4D



CA-12I

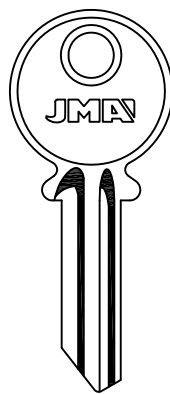

CA-5I



CA-11I

ZENITH-ZENICA

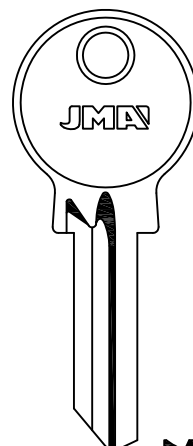

CA-6D



CA-13D

ZENITH-ZENICA

**PARA-FOR:**

CARTERO (E)

CAS CISMA (I)

CASH BOX (D)

CAVERS (F)



**PARA-FOR:**

- CAVERS (F)
- CAYS (E)
- CEMA (I)
- CENTURY (GB)
- CERRAMARC (E)

**CAVERS**

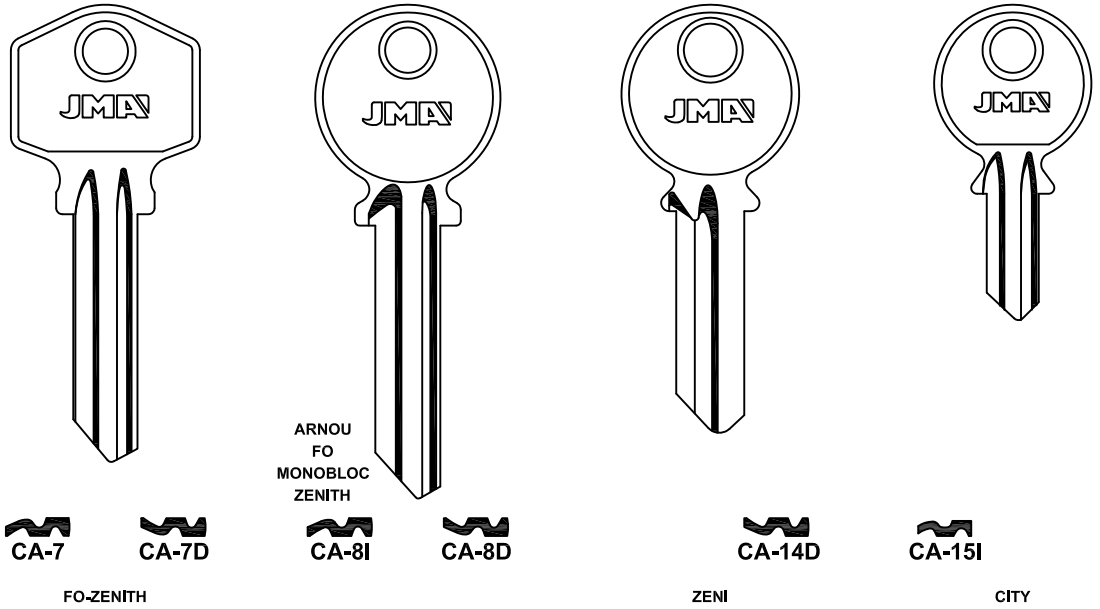

**CAYS**

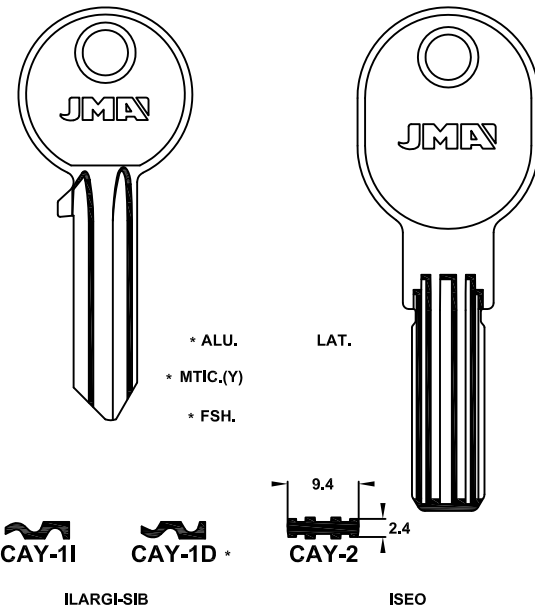

**CEMA**

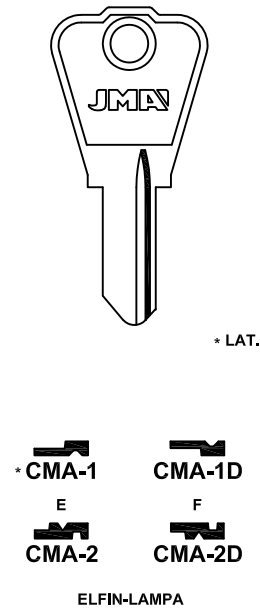

**CENTURY**

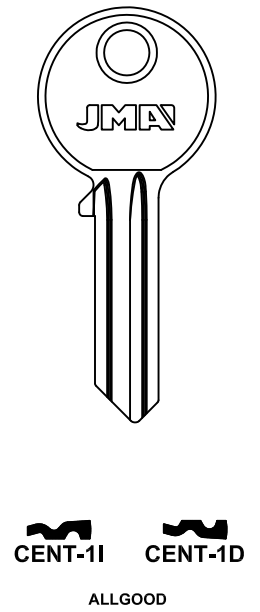

**CENTURY**

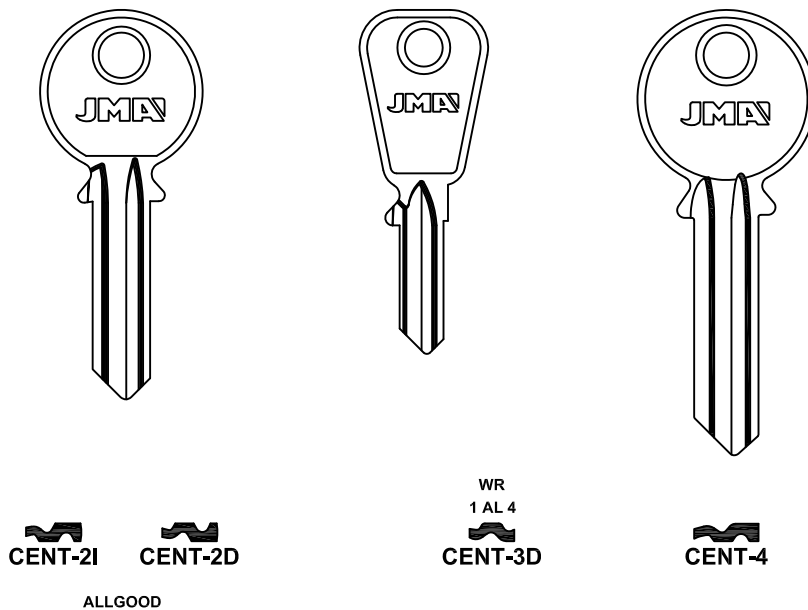

**CERRAMARC**

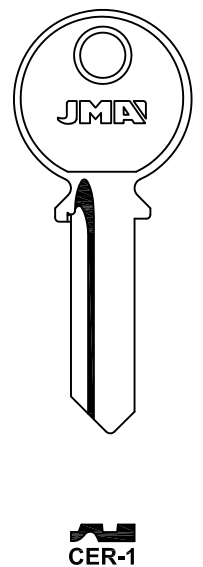

# CES

PARA-FOR:

CES (D)

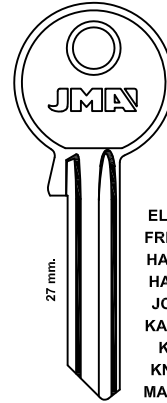
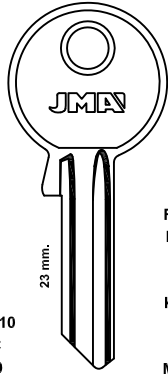
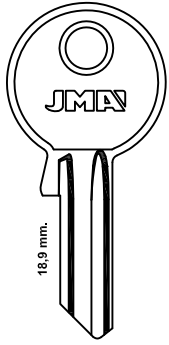

1C  
401-410  
10C  
1-10  
HLV  
911-950  
BODA  
ELZETT  
FRECOV  
KNAPP

ELZETT  
FRECOV  
HAFELE  
HANNO  
JOSTA  
KARDEX  
KIND  
KNAPP  
MAUSER  
NEMEF  
OJMAR  
SANTIS  
VOKO  
WASO  
WECO

CE-110

CE-108

CE-101D

CE-100D

CE-99D

BODA  
ELZETT  
FRECOV  
KNAPP

CE-3I

ELZETT  
FRECOV  
HAFELE  
HANNO  
JOSTA  
KARDEX  
KIND  
KNAPP  
MAUSER  
NEMEF  
OJMAR  
VOKO  
WASO  
WECO

CE-3D

CE-1I

CE-1D

CE-2I

CE-2D

STUV

# CES

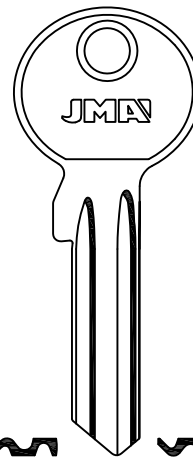
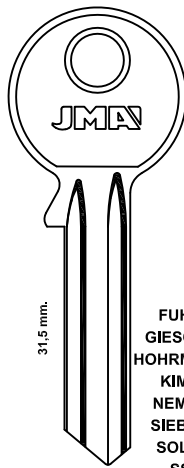
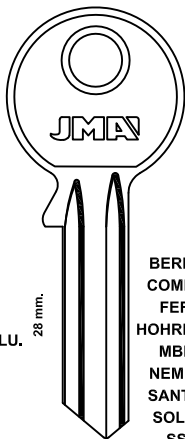
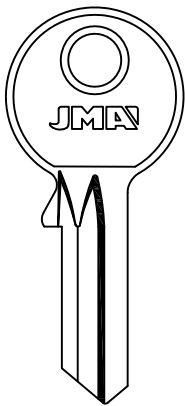

BERRY  
COMBA  
FEFI  
HOHRMANN  
MBB  
NEMEF  
SANTIS  
SOLID  
SS  
STUV  
TRITON

CE-92

CE-92D

FUHR  
GIESCHE  
HOHRMANN  
KIMA  
NEMEF  
SIEBAU  
SOLID  
SS  
STUV

SOLID

CE-7I

\*CE-7D

CE-4D

CE-5

CE-5D

CE-93D

CE-6I

CE-6D

CE-8D

CASMA-SPEEDAL

NEMEF

# CES

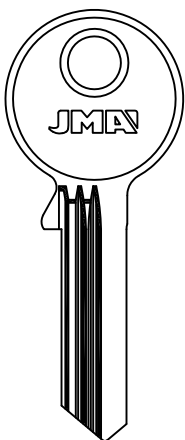

X23 CE-9D	X30 CE-16D	X37 CE-23D	W24 CE-30D	W31 CE-37D	
X24 CE-10D	X31 CE-17D	X38 CE-24D	W25 CE-31D	W32 CE-38D	W38 CE-44D
X25 CE-11D	X32 CE-18D	X39 CE-25D	W26 CE-32D	W33 CE-39D	W39 CE-45D
X26 CE-12D	X33 CE-19D	X40 CE-26D	W27 CE-33D	W34 CE-40D	W40 CE-46D
X27 CE-13D	X34 CE-20D	X41 CE-27D	W28 CE-34D	W35 CE-41D	W41 CE-47D
X28 CE-14D	X35 CE-21D	X42 CE-28D	W29 CE-35D	W36 CE-42D	W42 CE-48D
X29 CE-15D	X36 CE-22D	W23 CE-29D	W30 CE-36D	W37 CE-43D	CE-118D

SOLID



PARA-FOR:

CES (D)

CES

33 mm.

1Z...1-100000

BODA

LAT.

CES

31,5 mm.

LAT.

HÄFELE

BODA

CES

\* LAT.

LAT.

CE-89

CE-89D

CE-94

\* CE-133

CE-96

CE-97



CES

PARA-FOR:

CES (D)

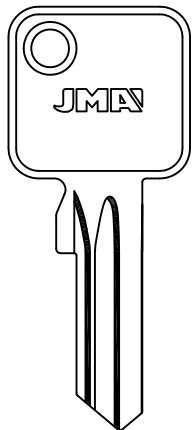

CASMA-SPEEDAL

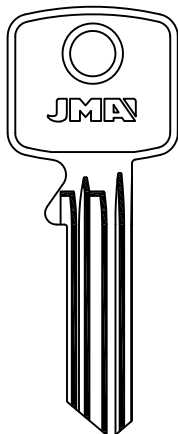

NEMEF

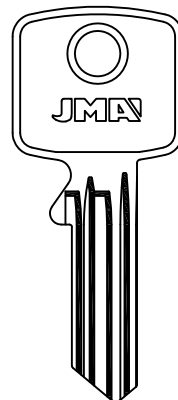

CES

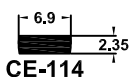
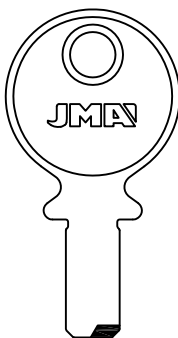
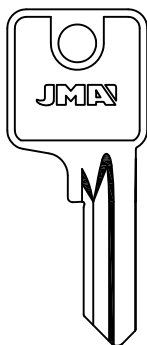

LAT.

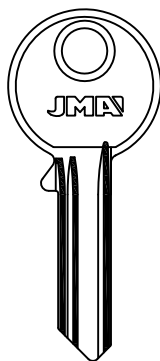

WS 401-410

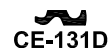
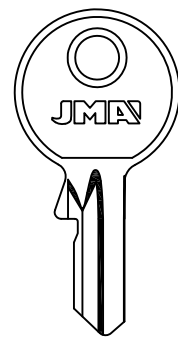

CES

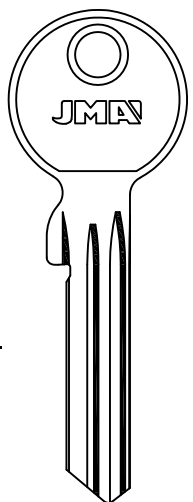

LAT.

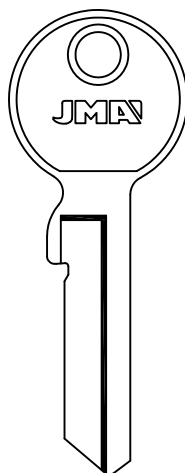
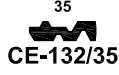
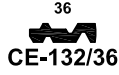
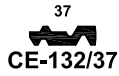
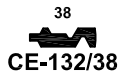
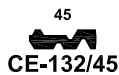
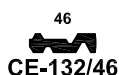
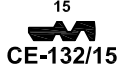
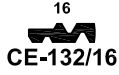
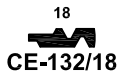
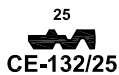
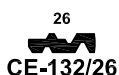
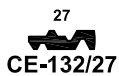

CE-134

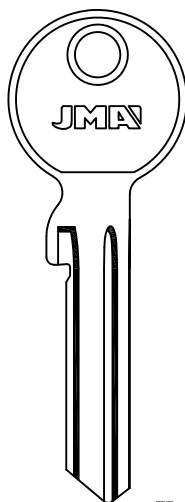

ALP.

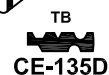









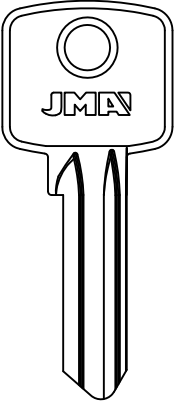
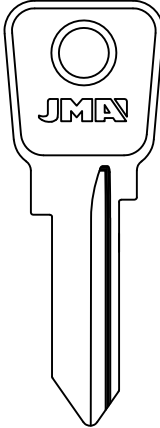
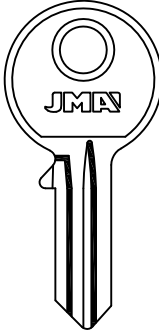
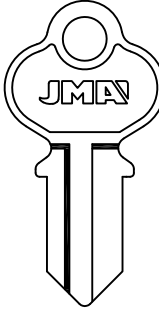

CE-135D









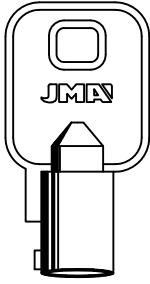
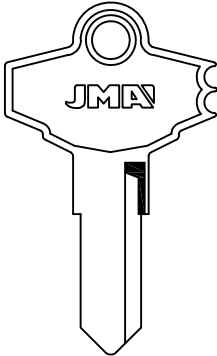
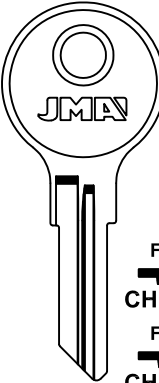
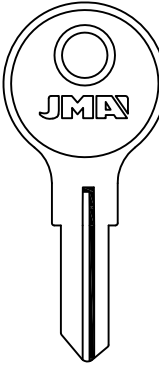

**PARA-FOR:**

- CHAVO (P)
- CHELIABINSK (RUS)
- CHEYLOCK (HK)
- CHICAGO (USA)
- CHUBB (GB)
- CIEF (F)
- CIELS (F)

CHAVO	CHELIABINSK	CHEYLOCK	CHICAGO
			
 CHA-2	 CHTZ-1	 CHEK-1	 CHI-1  CHI-2  CHI-3  CHI-4  CHI-5 







**CHICAGO**

			
 CHI-1T ACE-ADEMCO-AGA-ALPHA EURO LOCKS-FORT-GEM-L & F	 CHI-6 ILLINOIS ODA	 FR CHI-7D  FR CHI-8D  XF CHI-9D  XF CHI-10D	 CHI-12D

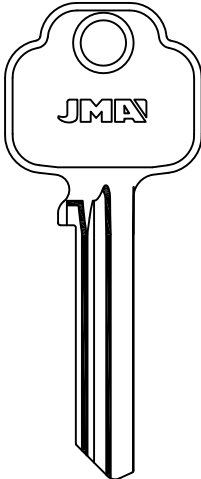
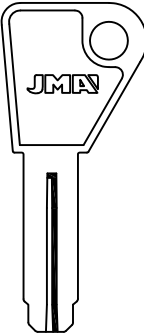
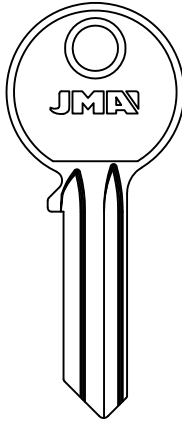
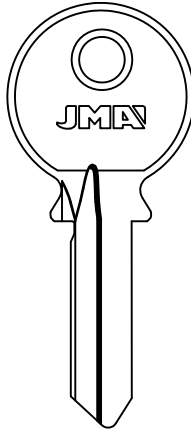
**CHUBB**

**CIEF**

**CIELS**

			
 CHU-1D	 CHU-10 AVA-CHUBB	 CF-1  CF-1D ESAFE-FEB	 CIE-1D





## CIFIAL

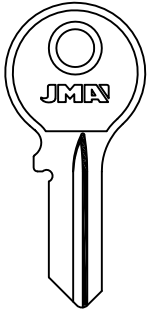

CIF-1D

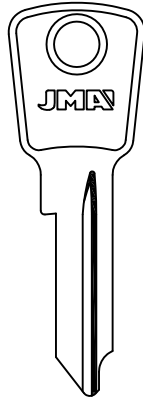

CIF-2D

LEFEBURE

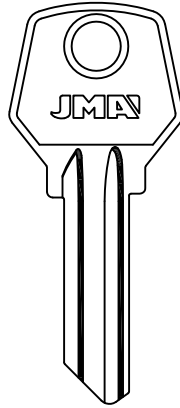

CIF-3

CIF-3D

EFER

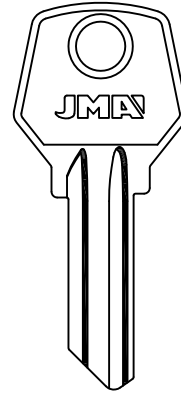

CIF-4

EFER

## PARA-FOR:

CIFIAL (P)

CILA-GENTILI (I)

CINA (RC)

CISA (I)

## CILA-GENTILI

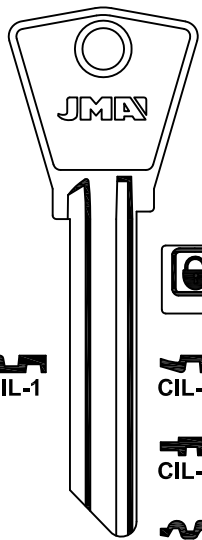

CIL-1



CIL-1D

CIL-2D

CIL-3D

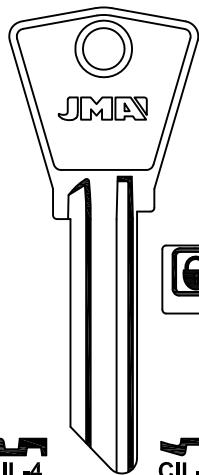

CIL-4



CIL-4D

CIL-5D

## CINA

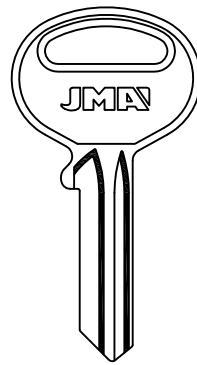

ALI-1

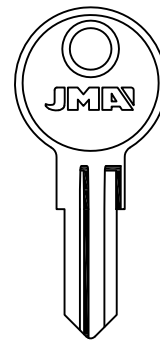

CIN-1

CIN-1D

## CINA

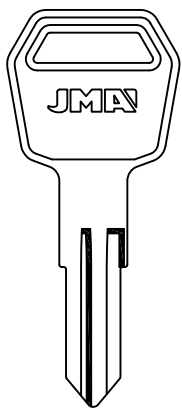

CIN-2

CIN-2D

## CISA

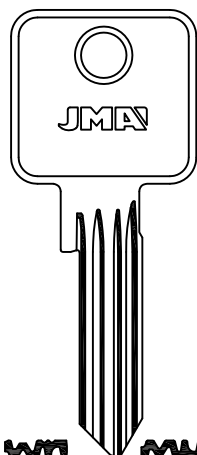

CI-11

CI-1D

CI-39D

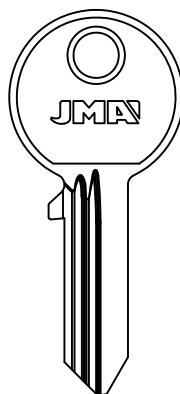

CI-4I

CI-4D

TZAFRER

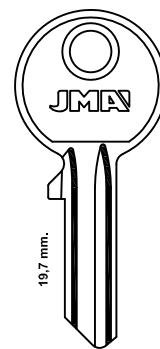

19,7 mm.



CI-4IP



CI-4DP

ABUS



PARA-FOR:

CISA (I)

CISA

23.2 mm.  
40

.....1 AL 6

CI-5IP CI-5DP CI-6I \*CI-6D CI-44D CI-58D

BATU-KUNERT

\*MTIC.  
ABUS  
CHAVO  
ESCO  
ESSENDIA  
ITO  
GEFI  
GETE  
GTV  
NB  
SCHUCO  
STANDARD

CI-14

A/AZIZA/Z.....  
000001-030198

CI-17

JPM

ABUS-ASTRAL-BRICARD

LAT.

CISA

CI-19D

70

CI-20 CI-20D

8.17  
2.82

CI-21 CI-25 CI-26 CI-30

CI-31 CI-32 CI-33 CI-35 CI-56 CI-59

CI-60 CI-67

LAT.

ABUS-ASTRAL-AXIS

CISA

30

CI-22D

70

.....1 AL 6

CI-23D

70

CI-24

CI-28D

ABUS

ABUS

LAT.



# CISA

PARA-FOR:

CISA (I)

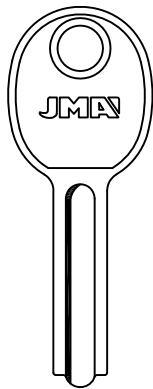

CI-41

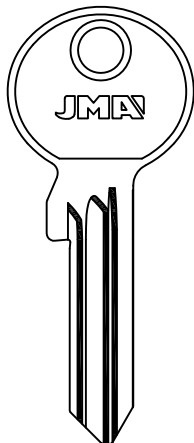

A  
CI-43D

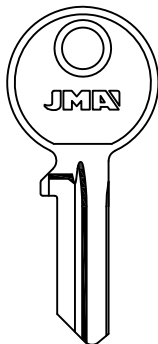

CI-45D

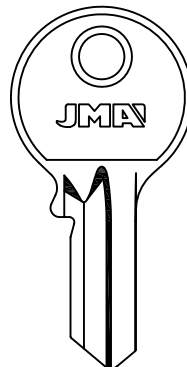

CI-46D

ABUS

# CISA

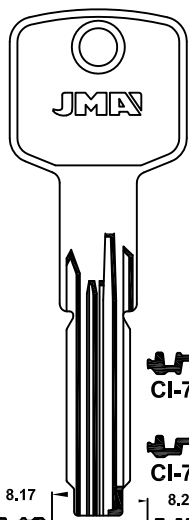

LAT.

8.17  
2.98  
CI-48

ABUS

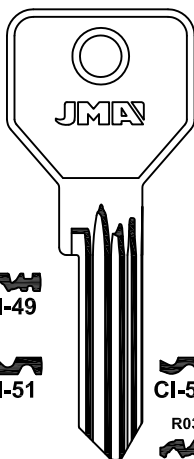

CI-49

CI-51

R032  
CI-61

CI-51D  
R033  
CI-55D

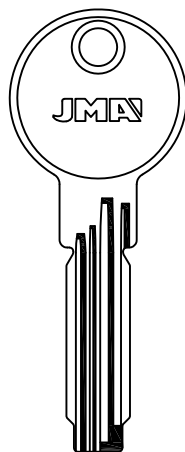

LAT.

8.2  
2.85  
CI-57

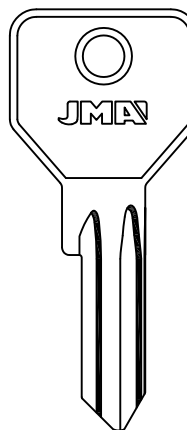

CI-62

CI-62D

# CISA

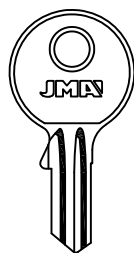

CI-65

ABUS-ALA

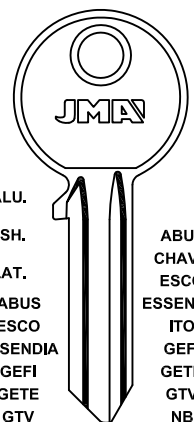

ALU.

\* FSH.

\* LAT.

ABUS

ESCO

ESSENDIA

GEFI

GETE

GTV

NB

SCHUCO

STANDARD



50-60

CI-1L

\*\* CI-DL

ABUS

CHAVO

ESCO

ESSENDIA

ITO

GEFI

GETE

GTV

NB

SCHUCO

STANDARD

TREE

CI-21

20  
CI-9D

04-05-07  
CI-11D

33  
CI-13

CI-15

R002  
CI-18

R005-19  
CI-29

CI-21

A  
CI-2

02  
CI-8D

08  
CI-10D

11  
CI-12

CI-15D

CI-16D

CI-27

CI-2

CI-34

R007  
CI-36

CI-38D

CI-42

CI-53

CI-16D

CI-27

CI-34

CI-34D

CI-36

CI-38D

CI-70

CI-69

CI-69

CI-69

CI-63

CI-34D

CI-36

CI-38D

CI-70

CI-69

CI-69

CI-69

CI-63

CI-34D

CI-36

CI-38D

CI-70

CI-69

CI-69

CI-69

CI-63

LAT.



15

LAT.



50-60

\* CI-66D

CI-64D











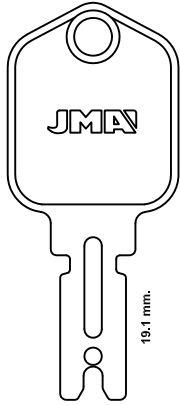

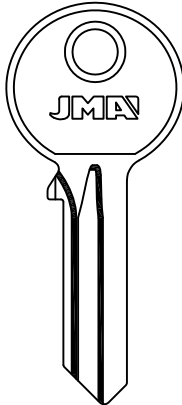

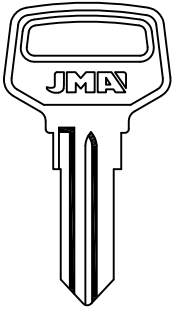
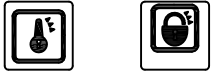

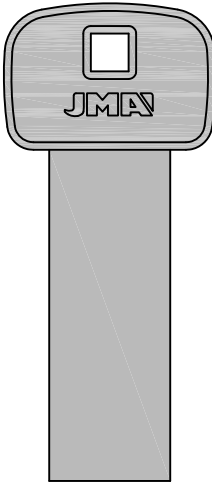

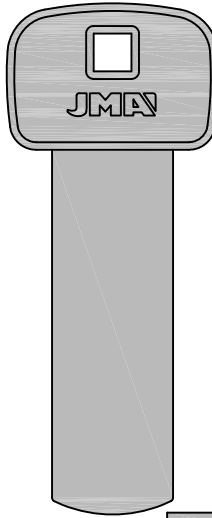

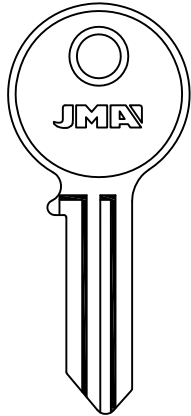
CI-63

CI-63D

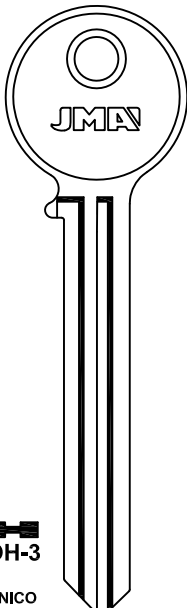

**PARA-FOR:**

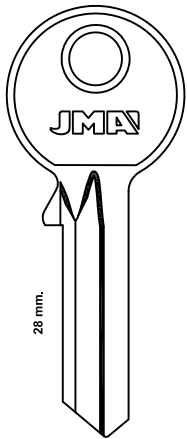
- CLARK FORK LIFT  
(USA)
- CLASSIC
- CLAUSOR (E)
- CLEMSA (E)
- COHNKO (RUS)
- COM (D)

CLARK FORK LIFT	CLASSIC	CLAUSOR
 <p>19.1 mm. LAT.</p>  <p><b>CLF-1</b> YALE</p>	  <p><b>CLS-1D</b></p>	 <p>ALU.</p>   <p><b>CL-1I</b> BRABANTIA</p>
CLEMSA		COHNKO
  <p><b>MG-6I</b></p>	 <p>PLAS.</p>  <p><b>MG-6S</b></p>	 <p>PLAS.</p>  <p><b>COH-1</b></p>  <p><b>COH-2</b></p>  <p><b>COH-2D</b> SONICO</p>
COHNKO		COM
  <p><b>COH-3</b> SONICO</p>	  <p><b>COH-4</b></p>	 <p>28 mm.</p>  <p><b>COM-1D</b></p>



# CORBIN

PARA-FOR:  
CORBIN (I)

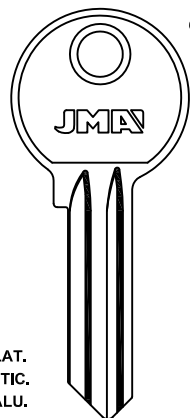

ALUNORM  
CRC-CAMBOA  
DOM  
ESCO  
EURONORM  
HEGO  
HESTE  
ISSERSTEDT  
KAWE  
LITTO  
MERMIER  
MUKRA  
NEMEF  
NOVOFERM  
STREMLER  
SUL  
THONE  
VERSCO  
ZECE

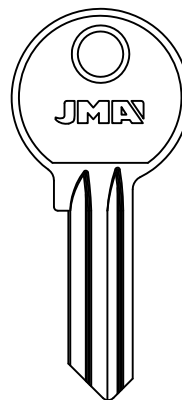
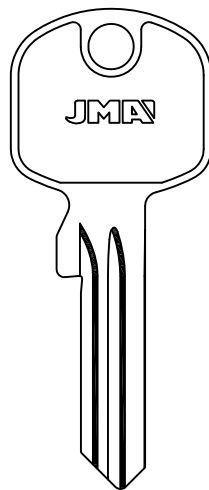

\* LAT.  
\*\* MTIC.  
\*\* ALU.

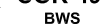

ESCO-KAWE-LITTO-NEMEF

# CORBIN

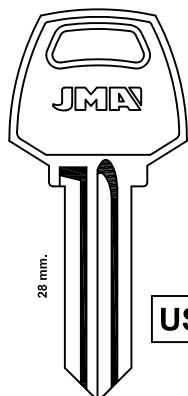

USA

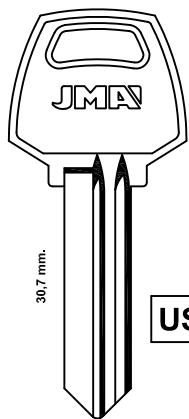

USA

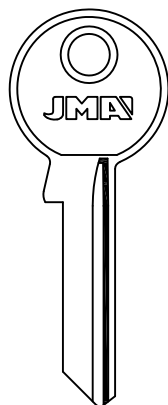

MASTER

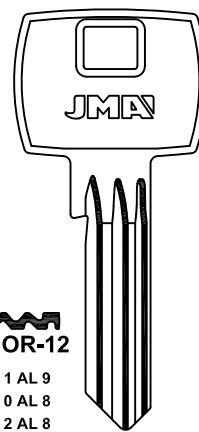

COR-12

1 AL 9  
0 AL 8  
2 AL 8



EUROPARTNER-FUCHS

# CORBIN

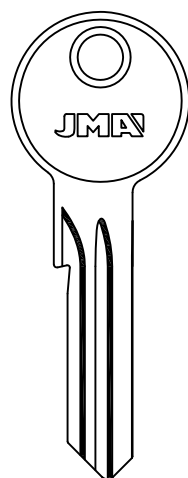

027  
\* COR-64

029  
\* COR-65

038  
\* COR-66

\* COR-67

\* COR-68

\* COR-71

\* LAT.

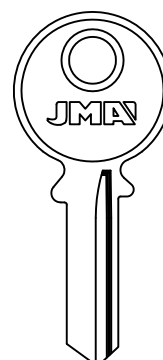
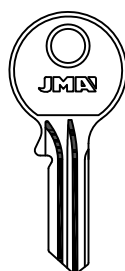

TESIO

**JMA**<sup>®</sup>

Copyright by Alejandro Altuna S.A. 2014



ATENCIÓN: Concerniente a las marcas y denominaciones comerciales ver nota en índice.  
ATTENTION: Concerning the marks and commercial denominations see note in index.  
ATTENTION: Concernant les marques et dénominations commerciales voir la note dans l'index.  
ACHTUNG: Beziehen auf die marke und handelsname sehen sie die notiz im index.

**PARA-FOR:**

CORBIN (I)

**CORBIN**

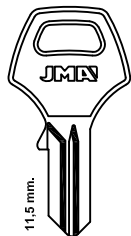

20-25  
1 AL 6

**COR-20/25**

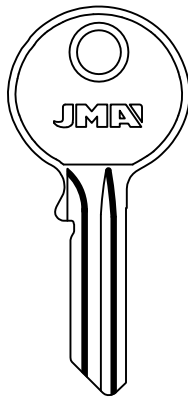

**COR-23D**

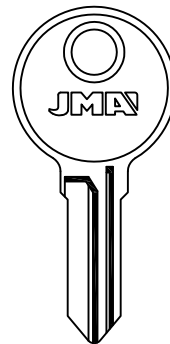

**COR-24**

**COR-24D**

CHANGE-O-MATIC

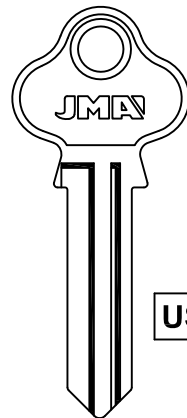

USA

**COR-25I**

**COR-25**

SKILMANN

**CORBIN**

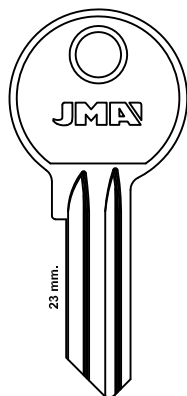

.....1 AL 7  
.....2 AL 7

**COR-26**

ESCO-EURONORM-KAWE-MUKRA

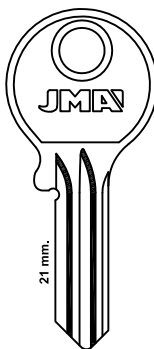

**COR-27D**

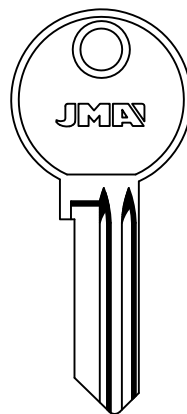

**COR-28**

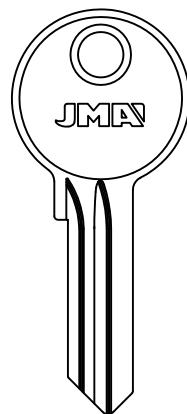

LAT.

**COR-29D**

**CORBIN**

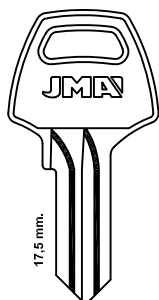

1 AL 9  
1 AL 7  
2 AL 7

**COR-30**

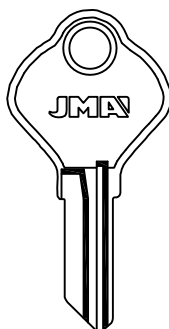

**COR-31**

CCL

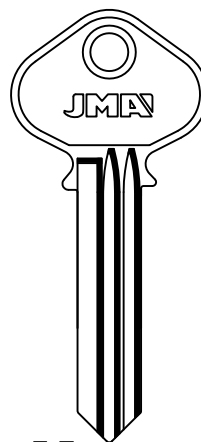

LAT.

**COR-32**

**COR-33**

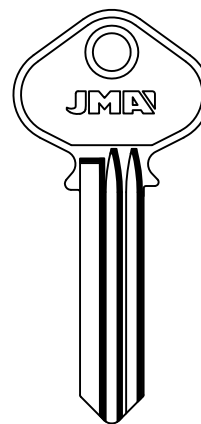

LAT.

**COR-34**





## CORBIN

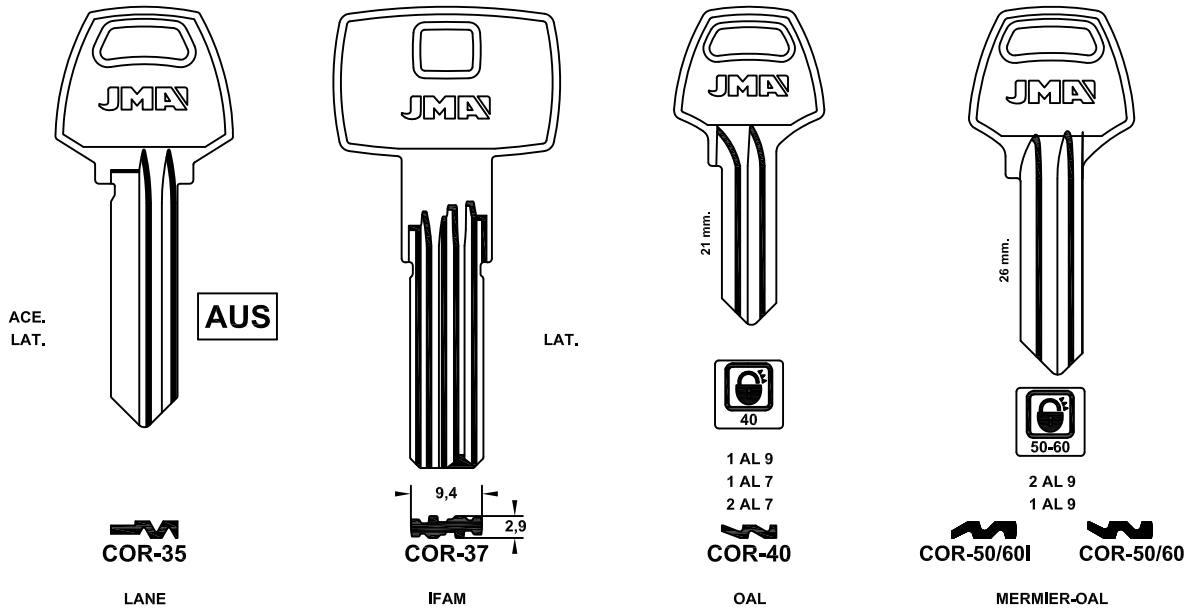

## PARA-FOR:

CORBIN (I)

CORONA (D)

## CORBIN

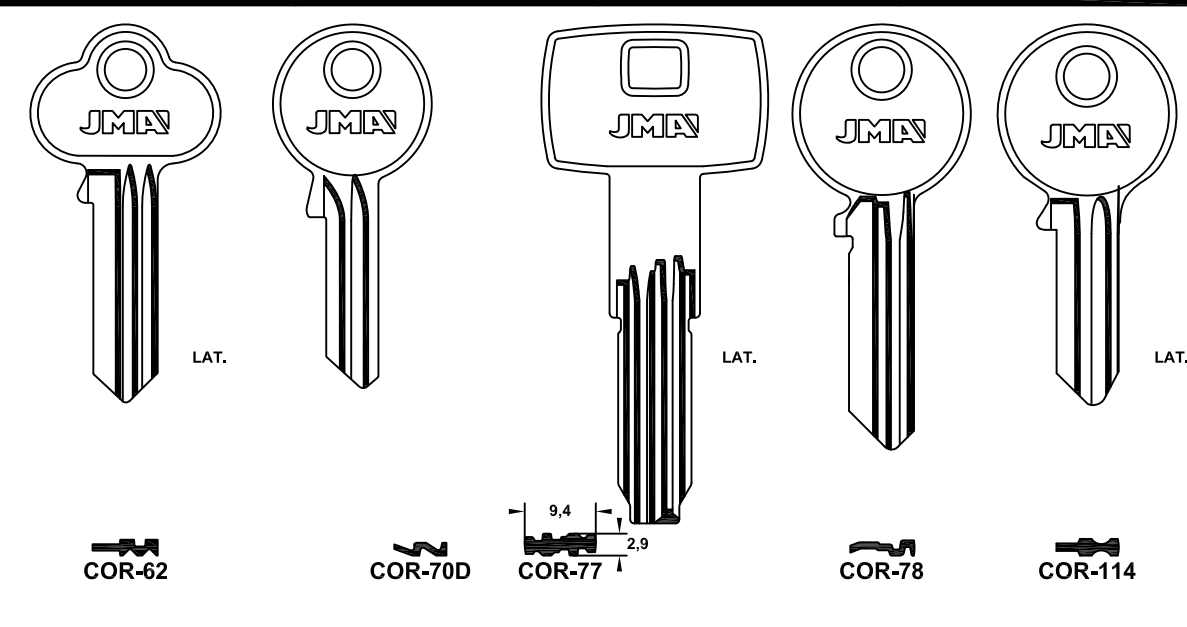



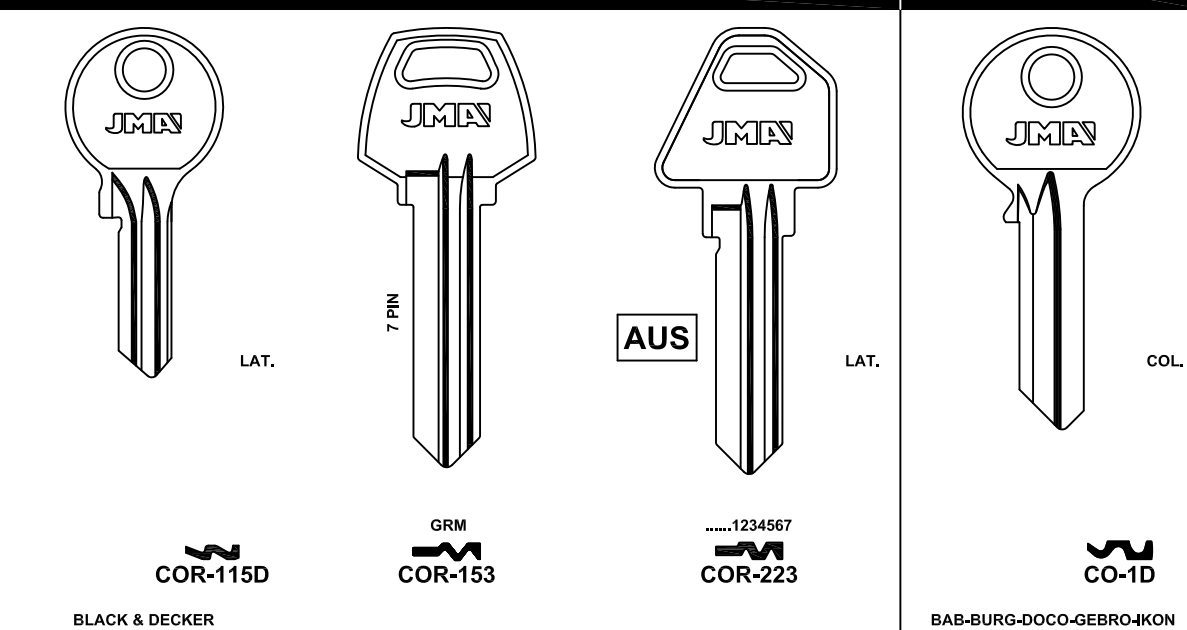

## CORBIN

## CORONA



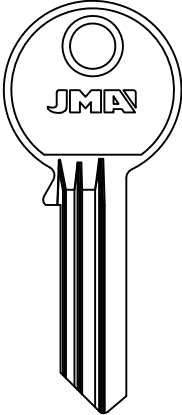
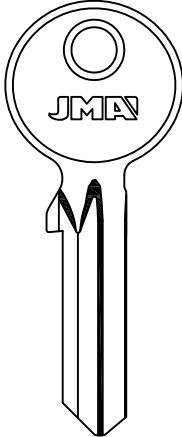
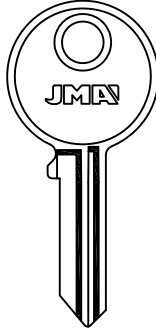
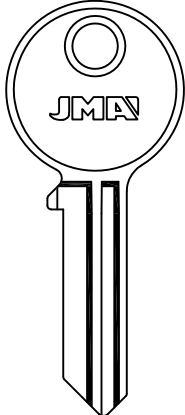





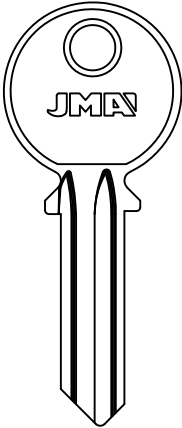
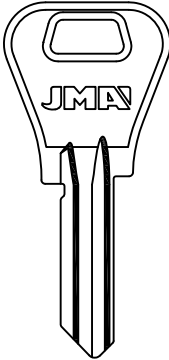
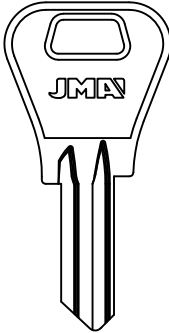
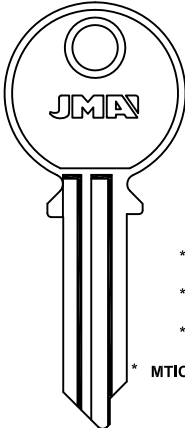

**PARA-FOR:**

- CORONA (D)
- COTICO (D)
- CRAZY LOCKS (RC)
- CUBELLS (E)
- CVL (E)
- DAD (F)











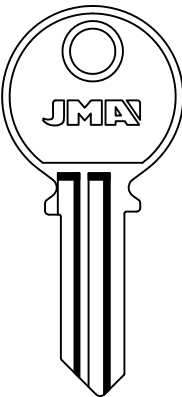
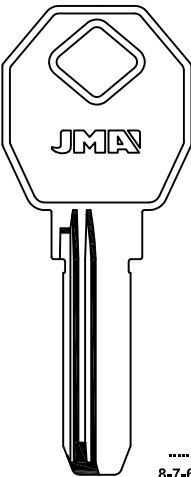
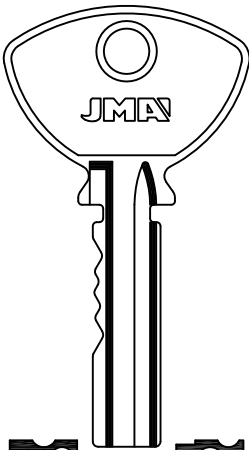
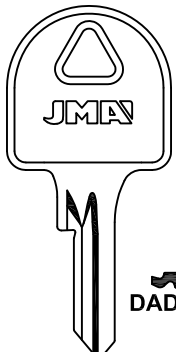

CORONA	COTICO	CRAZY LOCKS	CUBELLS
			
 CO-M	 COT-1D	 CLK-1	 CUB-1
IKON			

**CVL**

			
LAT. ALU.	LAT. ALU.		* FSH. * LAT. * ALU. * MTIC.(D-C)
 CVL-1I	 CVL-1D	 CVL-2I	 CVL-5I
 CVL-2D	 CVL-3I	 CVL-3D	 CVL-5D
SERRALLER	UCEM		AUMON-CAYS-CAZORLA-EURO FERMOD-JJ-PP-QCM

**CVL**

**DAD**

			
LAT.			
 CVL-6	 CVL-9D	 DAD-1I	 DAD-3D
 CVL-8D	 DAD-1D	 DAD-2I	 DAD-4D
	 DAD-2D	 DAD-5D	 DAD-6D
		DECAYEUX	ARFE-DECAYEUX



**DAF**

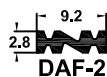
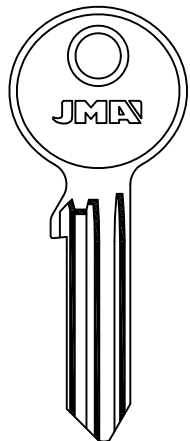

9.2  
2.8  
DAF-2



DAF-3D



DAF-4D

LAT.

**DEFA**

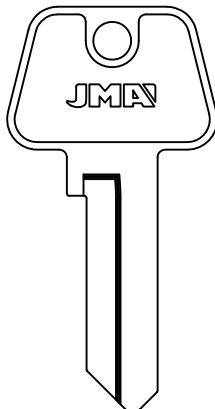

DEFA-1D

**DEKABA**

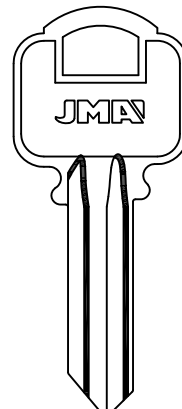

DEK-2



DEK-7D

MAUER

**PARA-FOR:**

DAF (TR)

DEFA (N)

DEKABA (BG)

DELAPORTE (F)

**DEKABA**

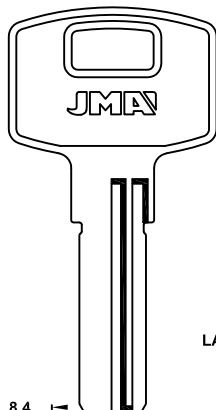

8.4  
2.45  
DEK-3

E2



DEK-8

MAUER

LAT.

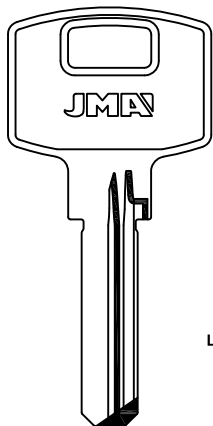

7.2  
2.5  
DEK-4

MAUER

LAT.

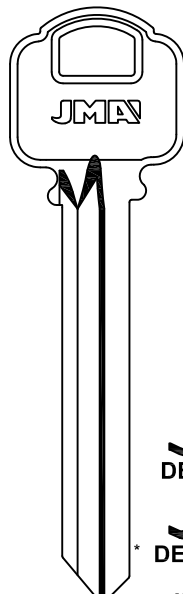

DEK-6D



DEK-14D

MAUER

\* LAT.

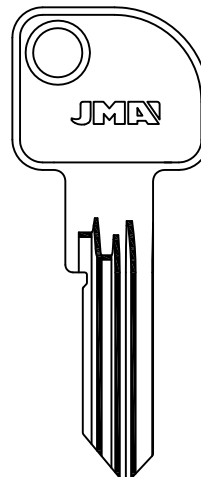

F  
DEK-9D

MAUER

**DEKABA**

**DELAPORTE**

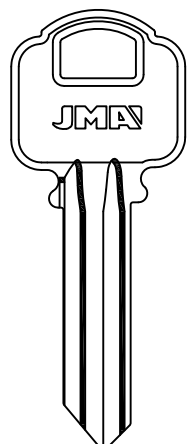

DEK-10

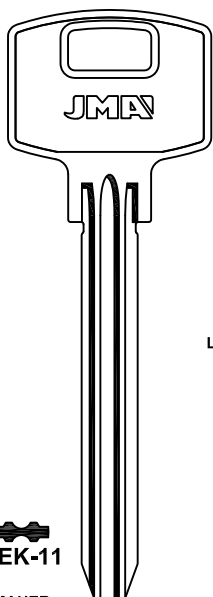

DEK-11

MAUER

LAT.

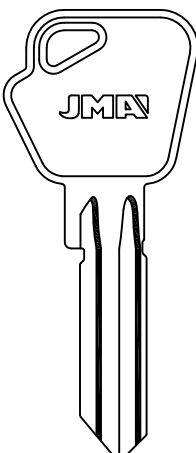

DEK-13

MAUER

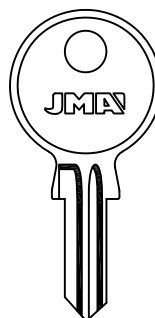

2501-2550













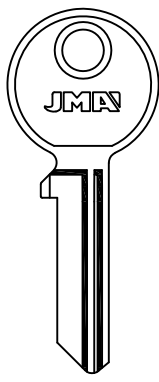

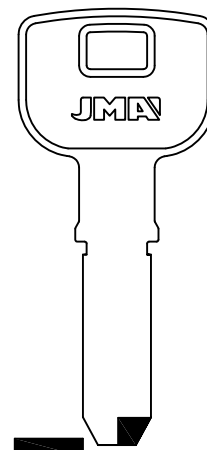

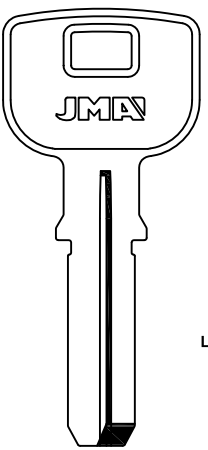

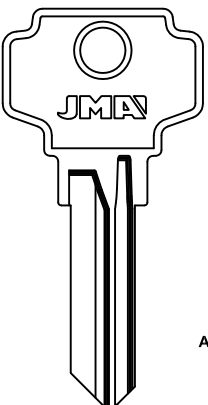

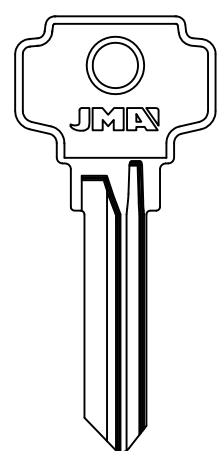
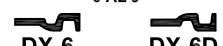
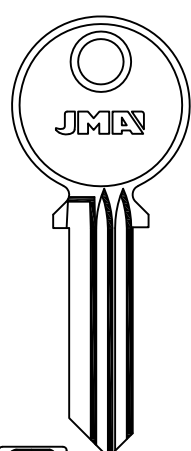

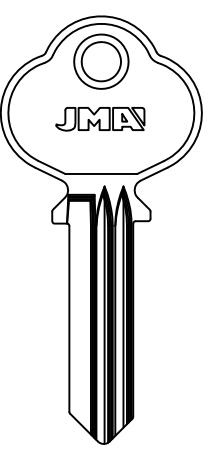
DLP-1

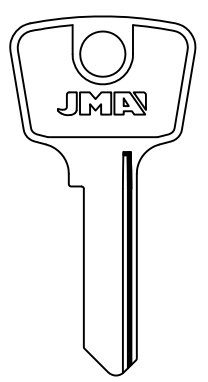
DIRAK-EMKA

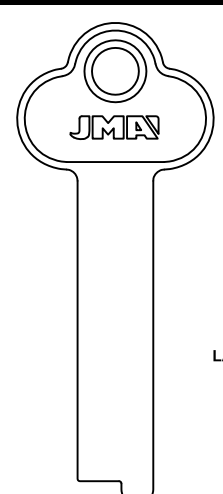

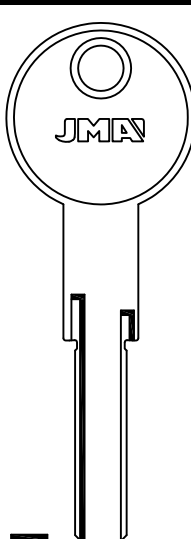
**PARA-FOR:**

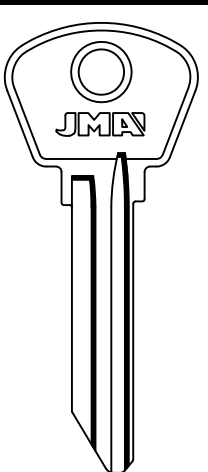
- DELAPORTE (F)
- DELCA (GR)
- DEXTER (I)
- DIAMOND (RC)
- DIEBOLD (D)
- DIERRE (I)
- DIMITROVGRAD (RUS)
- DOM (D)

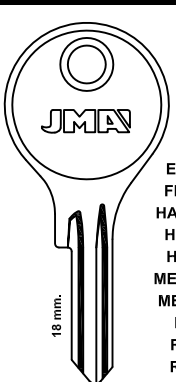
DELAPORTE	DELCA		DEXTER
  <b>DLP-2</b>	  <b>DLC-1</b> 9      2.4 <b>DLC-2</b> GEVY	  8.85      2.45 <b>DLC-3</b> GEVY	  0 AL 7 T 0 AL 9 0 AL 9 <b>DX-5</b> <b>DX-5D</b> ALU.
DEXTER	DIAMOND		
  0 AL 7 0 AL 9 <b>DX-6</b> <b>DX-6D</b>	  <b>DIA-1</b>	  <b>DIA-2</b>	  <b>DIA-3</b>
DIEBOLD	DIERRE	DIMITROVGRAD	DOM
  <b>DIE-1</b> LAT.	  <b>DR-1</b> ATRA	  <b>DM-1</b>	 18 mm. * ALU. * LAT. * FSH. BTV DAD ESAFE FECOR HAEFELE HEKNA HUWIL MECALUX METEOR MLM RENZ RUKA SCHLEGEL STS 2D 001-222 5A 0001-2600 9A 0001-5200 1D 601-654 <b>DOM-11</b> * <b>DOM-1D</b>



# DOM

PARA-FOR:

DOM (D)

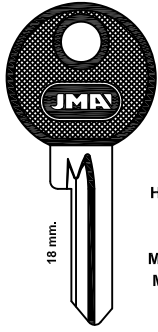

BTV  
DAD  
ESAFE  
FECOR  
HAEFELE  
HEKNA  
HUWIL  
MECALUX  
METEOR  
MLM  
RENZ  
RUKA  
SCHLEGEL  
STS

2D 001-222  
5A 0001-2600  
9A 0001-5200  
1D 601-654



DOM-1D.P

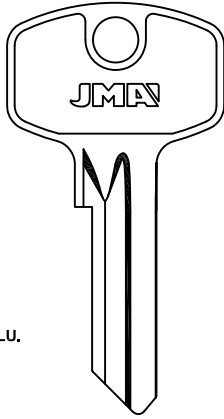

ALU.



DOM-2D

MOREAUX-STUV

C  
1301-1500  
C  
1001-1200  
CL  
001-250  
GP  
001-250

DOM-3I

DOM-4



DOM-3D



DOM-4D

DOM-8D

CHRIST

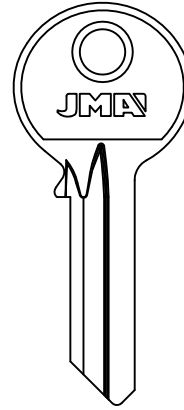

DOM-5D

STEIGA-STUV-VIKI

# DOM

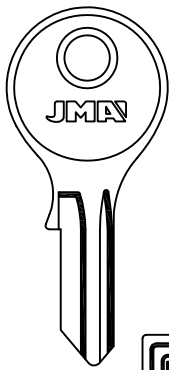

DN  
001-120  
80138-80728  
80761-83242

DOM-6I



DOM-6D

BARRO-IDEAL-TM

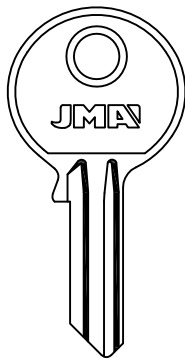

DOM-7I

EV  
0001-2840  
GD  
0001-1000  
4C  
0001-3000

DOM-7D

HOHRMANN

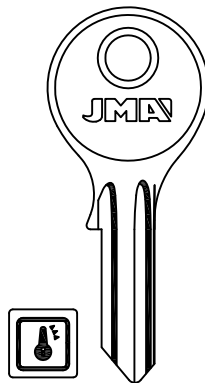

EV....1-2840

DOM-9

NOBO

EV....1-2840  
GS....1-1000  
FT....1-1000  
CQ....301-400  
....1-1000

DOM-9D

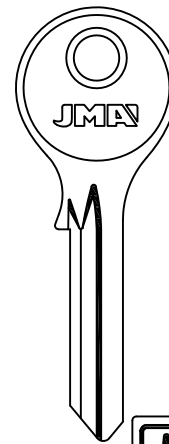

DOM-10D

# DOM

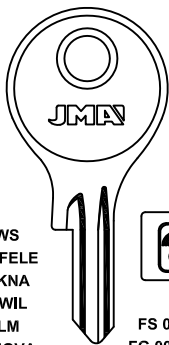

CWS  
HAEFELE  
HEKNA  
HUWIL  
MLM  
MENOVA  
METEOR  
RUKA  
SINJET  
STS

1D 058-114

DOM-11I

FS 01-60  
FG 001-615  
4A 001-182  
3A 01-82  
CF 001-140  
DB 001-148  
2A 01-34  
1D 01-57  
1D 501-560

DOM-11D

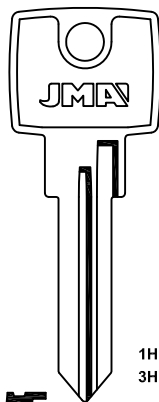

DOM-12

NOBO

1H 0001-4088  
3H 0001-0600

DOM-12D

ASPA

DOM-48

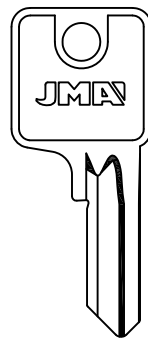

DOM-13D

DC....1-1800  
K.. 1-50  
GD....1-1800  
GZ....1-1800  
3E...1-350

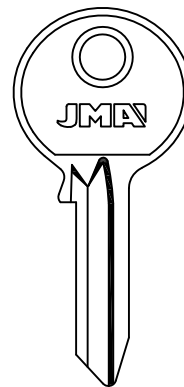

DOM-14D

FA-GZ  
0001-3948



PARA-FOR:

DOM (D)

DOM

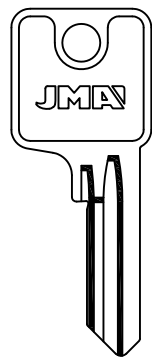

DOM-15D

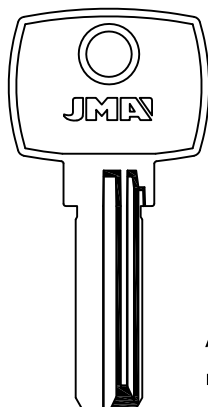

DOM-16D

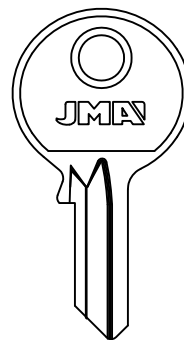

DOM-41D

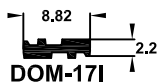
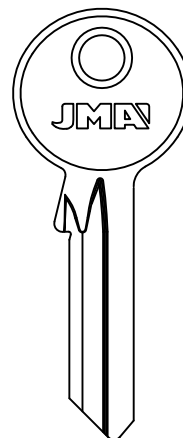

DOM-171

DOM-18D

DOM-20D

ALP.  
LAT.



CORBIN-EMHART

DOM

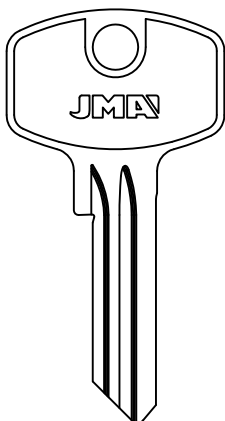

DOM-21D

CORBIN

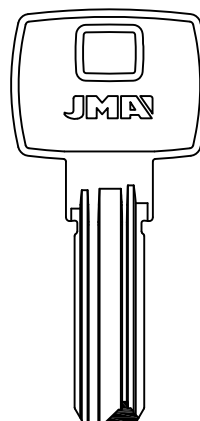

DOM-46D

ALP.

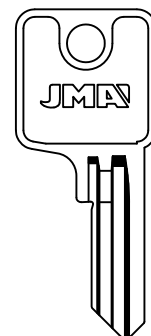

DOM-45

DOM-25D

DOM-44D

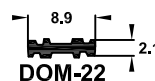

DOM-22

ARCU

DOM-49D

DOM

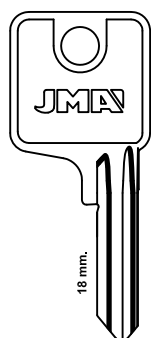

DOM-26

2D 001-222  
5A 0001-2600  
9A 0001-5200  
1D 601-654

DOM-26D

LAT.

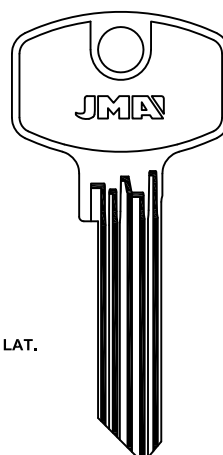

DOM-27/35

DOM-27/19

DOM-27/16

DOM-27/13

DOM-27/12





# DOM

PARA-FOR:

DOM (D)

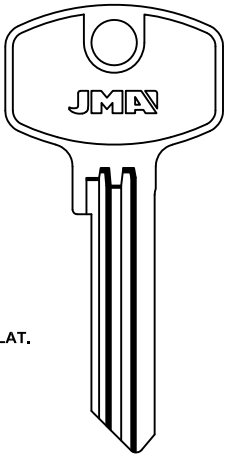

DOM-27D/2	DOM-27D/9	DOM-27D/16	DOM-27D/23	DOM-27D/30
DOM-27D/3	DOM-27D/10	DOM-27D/17	DOM-27D/24	DOM-27D/31
DOM-27D/4	DOM-27D/11	DOM-27D/18	DOM-27D/25	DOM-27D/32
DOM-27D/5	DOM-27D/12	DOM-27D/19	DOM-27D/26	DOM-27D/33
DOM-27D/6	DOM-27D/13	DOM-27D/20	DOM-27D/27	DOM-27D/34
DOM-27D/7	DOM-27D/14	DOM-27D/21	DOM-27D/28	DOM-27D/35
DOM-27D/1	DOM-27D/8	DOM-27D/15	DOM-27D/22	DOM-27D/36

DOM-27D/37	DOM-27D/44	DOM-27D/51	DOM-27D/58
DOM-27D/38	DOM-27D/45	DOM-27D/52	DOM-27D/59
DOM-27D/39	DOM-27D/46	DOM-27D/53	DOM-27D/60
DOM-27D/40	DOM-27D/47	DOM-27D/54	DOM-27D/61
DOM-27D/41	DOM-27D/48	DOM-27D/55	
DOM-27D/42	DOM-27D/49	DOM-27D/56	
DOM-27D/43	DOM-27D/50	DOM-27D/57	

# DOM

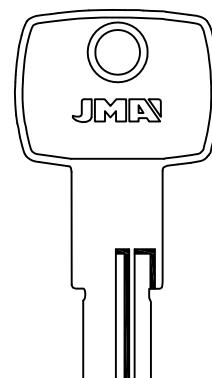
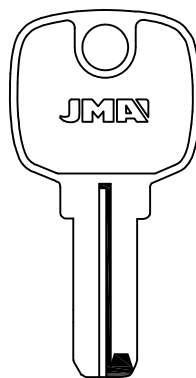
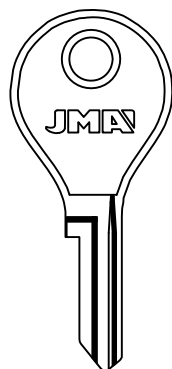
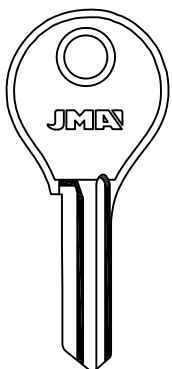

ALP.

LAT.

DOM-28 DOM-28D

6E...1-205  
 DOM-29

EA0

8.4  
 2.4  
DOM-30

MOREAUX

8.9  
 IX 5  
 2.35  
DOM-31

CORBIN-EMHART



PARA-FOR:

DOM (D)

DOM

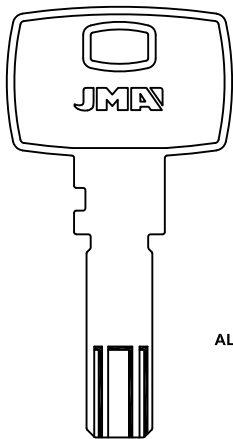

ALP.

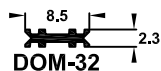

CORBIN-EMHART

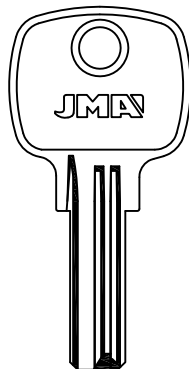

ALP.

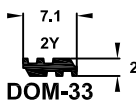

DOM-33

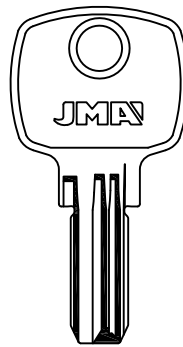

ALP.

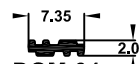

DOM-34



DOM-39

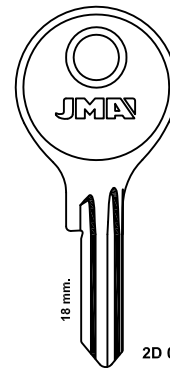

18 mm.

2D 001-222  
5A 0001-2600  
9A 0001-5200  
1D 601-654



DOM-35



DOM-35D



DOM-51

DOM

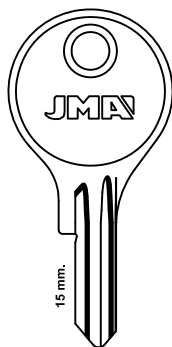

15 mm.

2D 001-222  
5A 0001-2600  
9A 0001-5200  
1D 601-654



DOM-36



DOM-36D

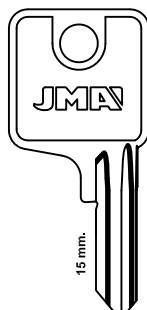

15 mm.

2D 001-222  
5A 0001-2600  
9A 0001-5200  
1D 601-654



DOM-37



DOM-37D

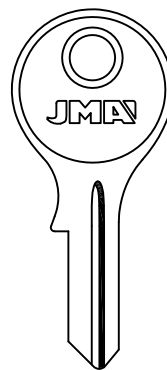

DOM-38D

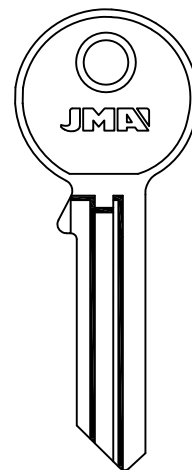

DOM-40D

DOM

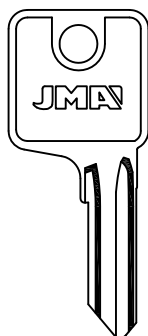

DOM-42  
FLAMBO-HEKNA-NOBO  
PEROHAUS

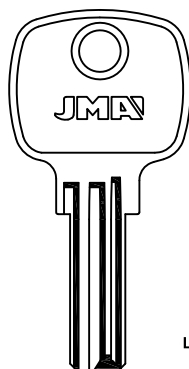

LAT.

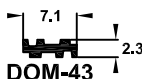

DOM-43

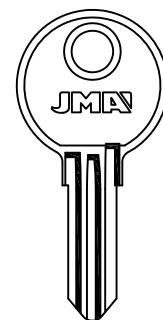

DOM-52

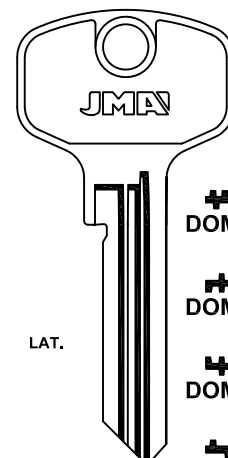

LAT.



DOM-74D



DOM-72D



DOM-58D



DOM-54D

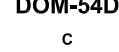

DOM-53D



## DOM

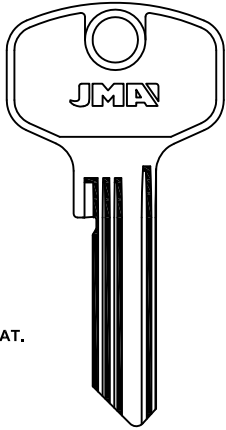

 DOM-73D

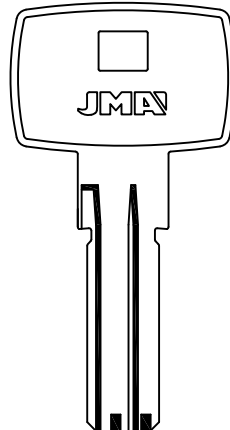

 DOM-71D

 DOM-65

 DOM-67D

 DOM-61

 DOM-60D

 DOM-59

 DOM-57

 DOM-57D

 DOM-55

 DOM-55D

 DOM-56D

 DOM-63D

 DOM-62D

STUV

LAT.

ALP.

## PARA-FOR:

DOM (D)

DOMINION LOCK  
(USA)

DOMUS (I)

## DOM

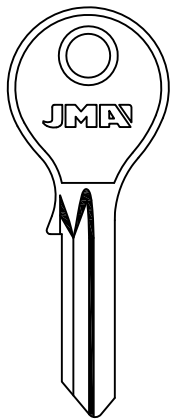

 DOM-64D

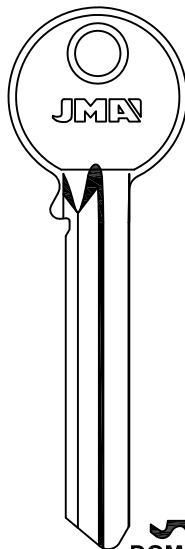

 DOM-66D

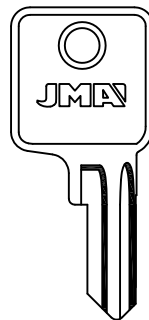

CL...1-250  
GP...1-250  
C...1001-1200  
C...1301-1500  
 DOM-68

GEWIRU

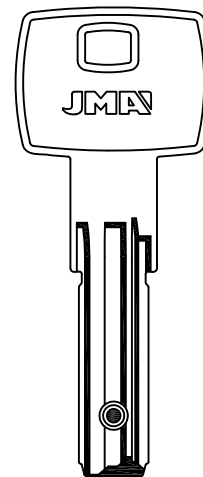

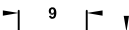
 DOM-B1

CORBIN-ST5

ALP.

## DOMINION LOCK

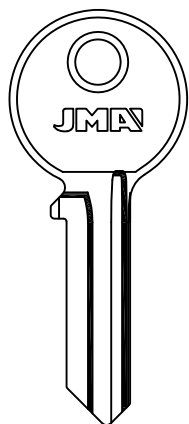

 DOI-1

PETERBORO

LAT.

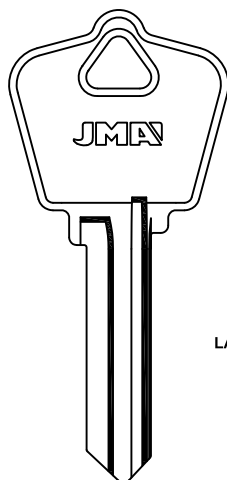

 DOI-4

LAT.

## DOMUS

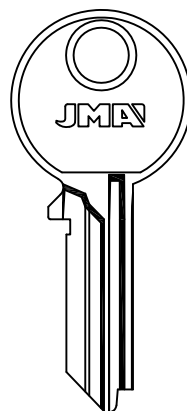

 DO-21

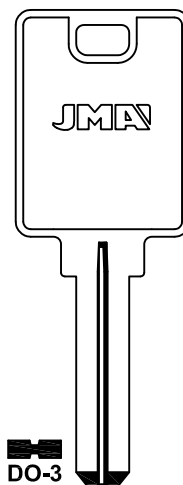

 DO-3











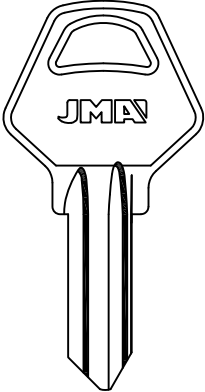
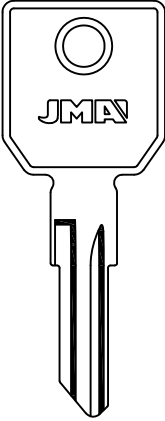
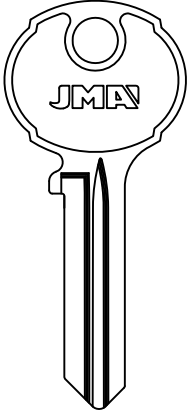
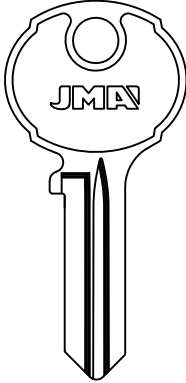





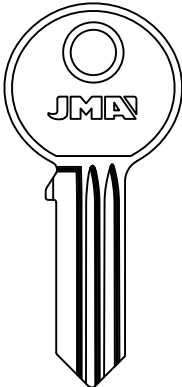

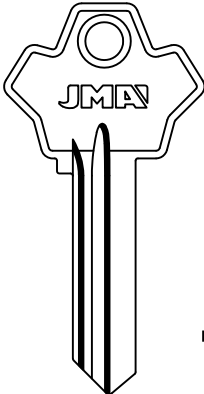
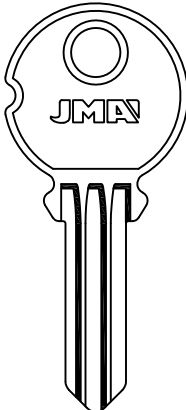
 DO-4

ALP.

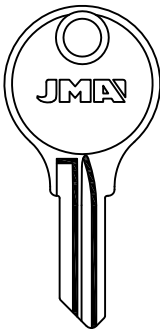
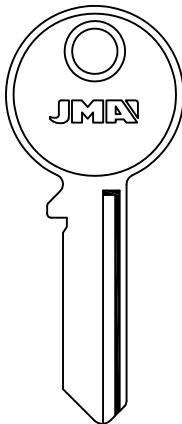
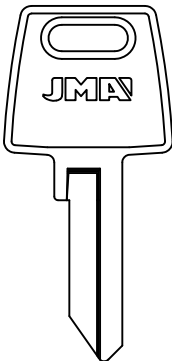
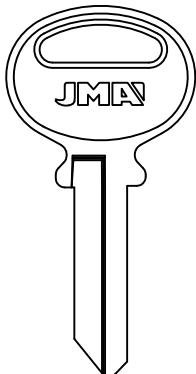

**PARA-FOR:**

- DOMUS (I)
- DOUBLE CIRCLE (RC)
- DURALOCK (USA)
- EAG (D)
- EAGLE (USA)
- ECM (I)
- EIKO (J)

DOMUS		DOUBLE CIRCLE	
			
 DO-5	 DO-5D	 DO-7	 DC-1D
			 DC-2D
		TRI CIRCLE	
DOUBLE CIRCLE		DURALOCK	EAG
			
 DC-3	 DC-4D	 DUR-1D	 EG-2
			 EG-1
		LAT.	
EAGLE	ECM	EIKO	
			
 EAG-2D	 EC-1	 EI-1D	 EI-2D
EZ... PZ... 1-240			CINA
LAT.			



**ELZETT**



**ELZ-10**

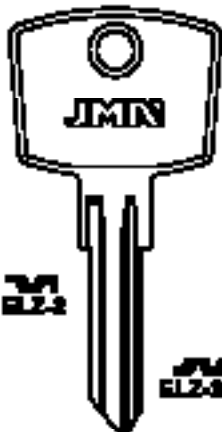

**ELZ-4**

**ELZ-80**

**ELZ-40**

**ELZ-80**



**ELZ-80**



**ELZ-80**

TIPENTAL-TUB

**ELZETT**



**ELZ-4**



LAT.

**ELZ-10** **ELZ-110**



**ELZ-110**



**ELZ-12**

**ELZ-120**

**EMKA**

**EP PINSON**

**ERA**



**EMK-1**



**EP-10**



**ER-10**



**ER-20**

**PARA-FOR:**

**ELZETT (H)**

**EMKA (F)**











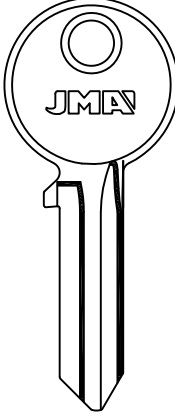
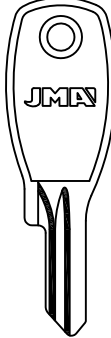
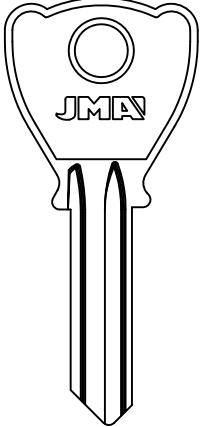

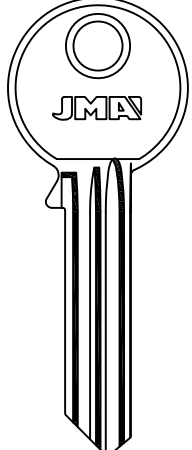





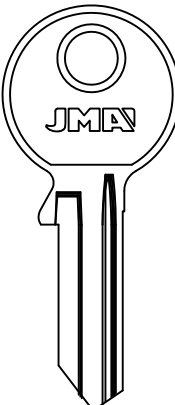
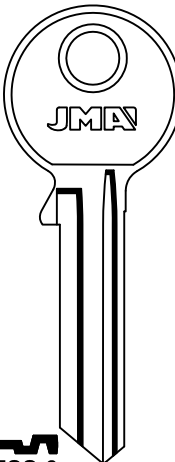
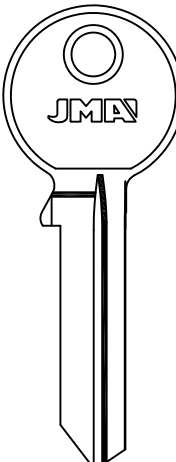
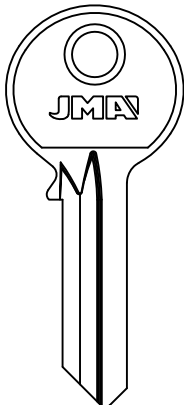



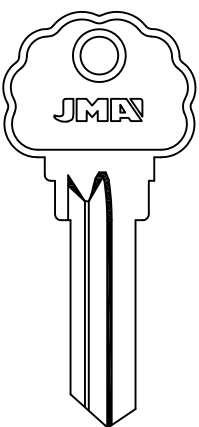
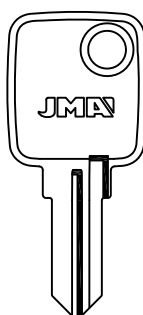
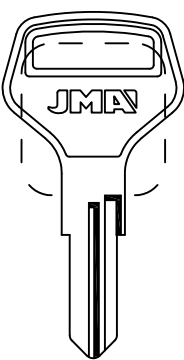
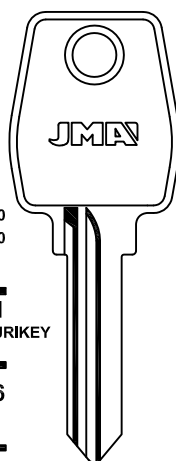

**EP PINSON (GB)**

**ERA (GB)**



**PARA-FOR:**

- ERA (GB)
- ESA (E)
- ESLA (GB)
- ESS (D)
- ETAS (GB)
- EUREKA (I)
- EURO BOX
- EURO LOCKS (B)

ERA		ESA	ESLA
 		 	 
 ER-3		 ER-4D	 ES-1I  ES-1D NUMIDA
ESS			ETAS
  			 
 ESS-1  ESS-3  ESS-2  ESS-4			 E00  ESS-9D BAB
 ETS-1D YANEDIS			
EUREKA	EURO BOX		EURO LOCKS
	 		 47001-48000 45000-47000 1201-1400  EU-1 EMKA-SECURIKEY  EU-6  EU-9  EU-10D  EU-14D
 EUR-1D	 EUB-1  EUB-2 BRABANTIA-MARS-WEDO		



## EURO LOCKS

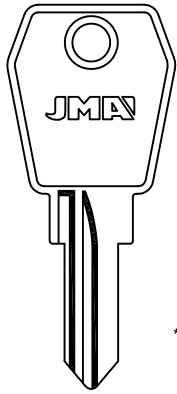

\* ALU.



EU-13D

25001-27000



\* EU-2

FASMA-L.&F.

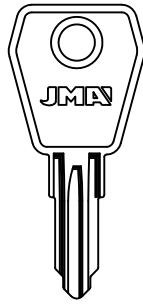

EU-3

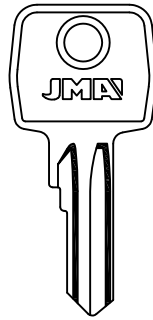

....  
....A  
458-5124



EU-4

....  
....E  
405-4324



EU-4D

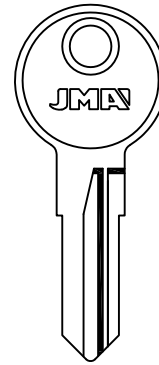

EU-7



EU-7D



EU-11

## PARA-FOR:

EURO LOCKS

(B)

EVERGOOD (RC)

EVVA (A)

## EURO LOCKS

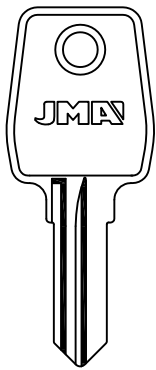

EU-8D

L&F

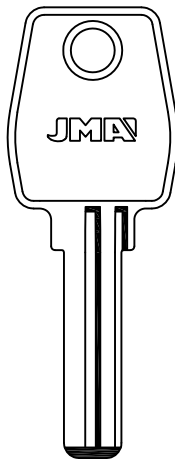

LAT.

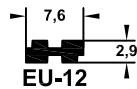

EU-12

HOBBY-HYMER

## EVERGOOD

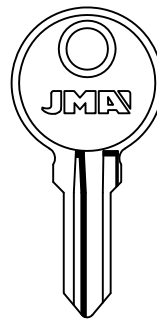

EVE-1

ARREGUI



EVE-1D

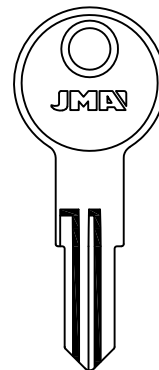

EVE-2D

## EVERGOOD

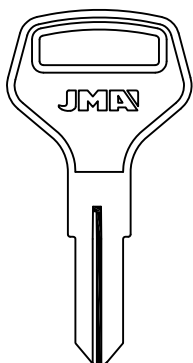

EVE-3D

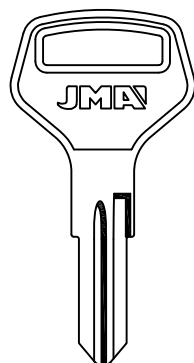

EVE-4

## EVVA

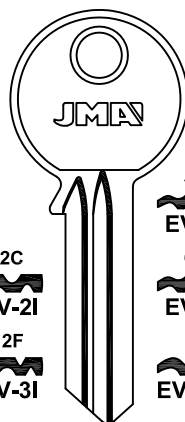

\* LAT.



EV-2I



EV-3I



EV-1



EV-2



EV-3D



EV-13D



EV-25D

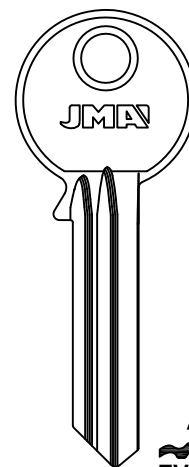

EV-4D

ELCA

**JMA**<sup>®</sup>

Copyright by Alejandro Altuna S.A. 2014



ATENCIÓN: Concerniente a las marcas y denominaciones comerciales ver nota en índice.  
ATTENTION: Concerning the marks and commercial denominations see note in index.  
ATTENTION: Concernant les marques et dénominations commerciales voir la note dans l'index.  
ACHTUNG: Beziehen auf die marke und handelsname sehen sie die notiz im index.



**PARA-FOR:**

EVVA (A)

EXCEL (F)

EXPRES (PL)

EZCURRA (E)

**EVVA**

A  
EV-6D \* EV-27D/5 \* EV-27D/10

C  
EV-7D \* EV-27D/4 \* EV-27D/9

F  
EV-8D \* EV-27D/3 \* EV-27D/8

S  
EV-9D \* EV-27D/2 \* EV-27D/7

EV-23D \* EV-27D/1 \* EV-27D/6

K0  
...101-1479  
EV-11

K1  
...2001-2479  
EV-11D

EV-12D

EV-19  
NM...  
50000-54999  
EV-19  
NM...  
65000-69999  
EV-24

ELCA-TRYBA

EVVA		EXCEL		EXPRES	
	LAT.				
....(K1) 4001-4250 EV-20D		SIDLEEN EX-1D		EXS-1D	WT EXS-3
					RST EXS-2D WTR EXS-3D
EXPRES			EZCURRA		
		EXS-4D	EXS-5 EXS-5D	* ALU. * LAT. * FSH. EZ-11	EZ-1D
SISO		SISO	EXS-6		EZ-21



## EZCURRA

PARA-FOR:

EZCURRA (E)

FAB (CZ)

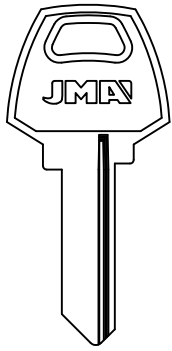

EZ-3I

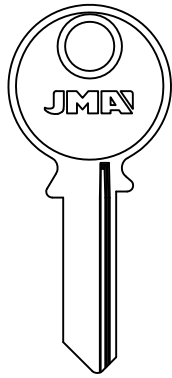

EZ-3D

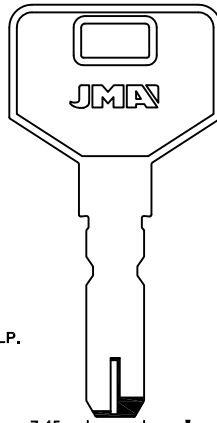

EZ-DS10  
CAS

EZ-DS10E

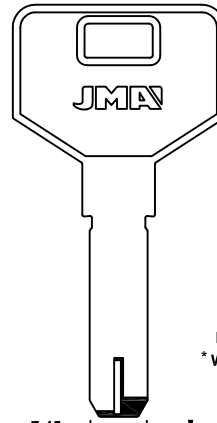

EZ-DS15

\* EZ-DS15R

ALP.

LAT.  
\* WNC.

## FAB

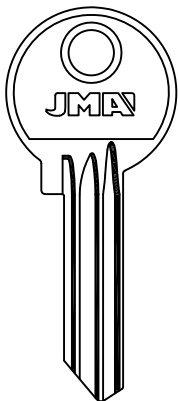

11  
FB-1

8  
FB-3

9  
FB-19

10  
FB-20

12  
FB-21

13  
FB-22

14  
FB-23

15  
FB-24

16  
FB-25

FB-31

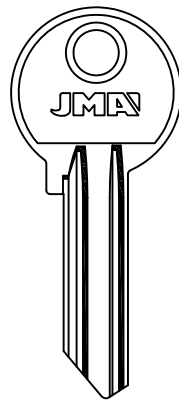

22  
FB-21

FB-2D

10X  
FB-4

11X  
FB-5

20  
FB-6

21  
FB-7

23  
FB-8

24  
FB-9

26  
FB-10

30  
FB-11

32  
FB-12

12X  
FB-26

14X  
FB-29

## FAB

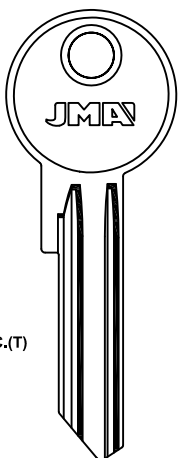

PR22  
\* FB-13

PR23  
FB-14

PR24  
FB-15

PR26  
FB-16

PR30  
\* FB-17

PR32  
FB-18

PR20  
\* FB-27

PR21  
FB-28

10X  
FB-32

12X  
FB-34

11X  
FB-35

K  
FB-38

14X  
FB-41

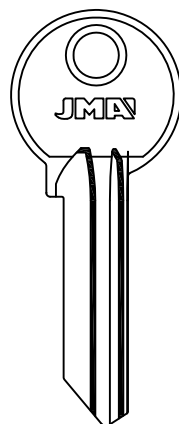

FB-33

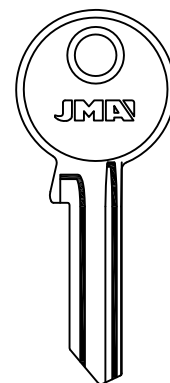

FB-39

\* MTIC.(T)

**JMA**<sup>®</sup>

Copyright by Alejandro Altuna S.A. 2014



ATENCIÓN: Concerniente a las marcas y denominaciones comerciales ver nota en índice.  
ATTENTION: Concerning the marks and commercial denominations see note in index.  
ATTENTION: Concernant les marques et dénominations commerciales voir la note dans l'index.  
ACHTUNG: Beziehen auf die marke und handelsname sehen sie die notiz im index.

PARA-FOR:

FAC (E)

FAC

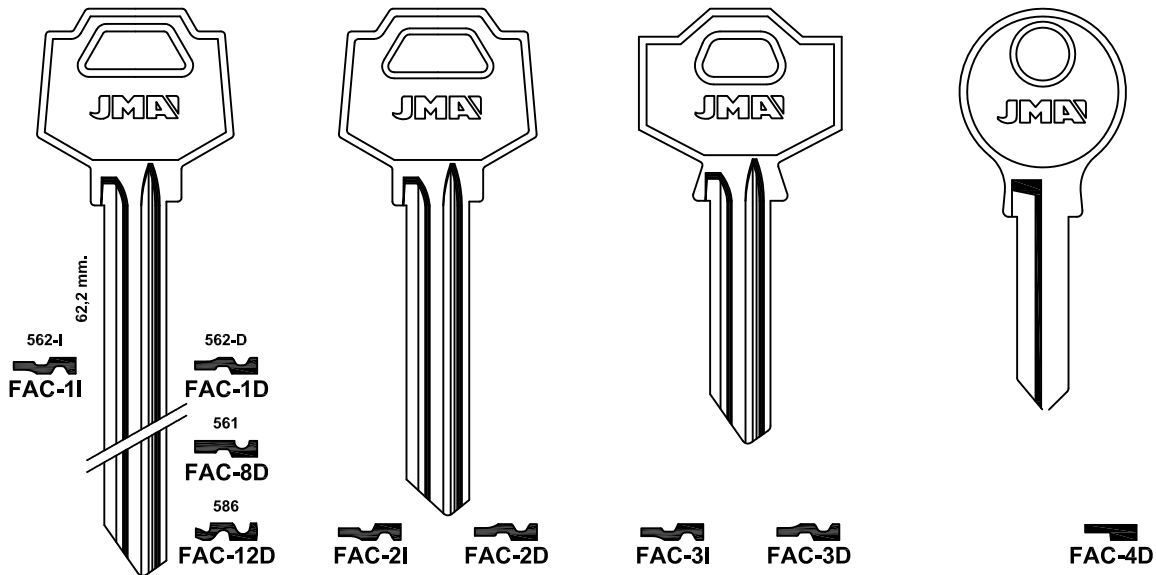

FAC

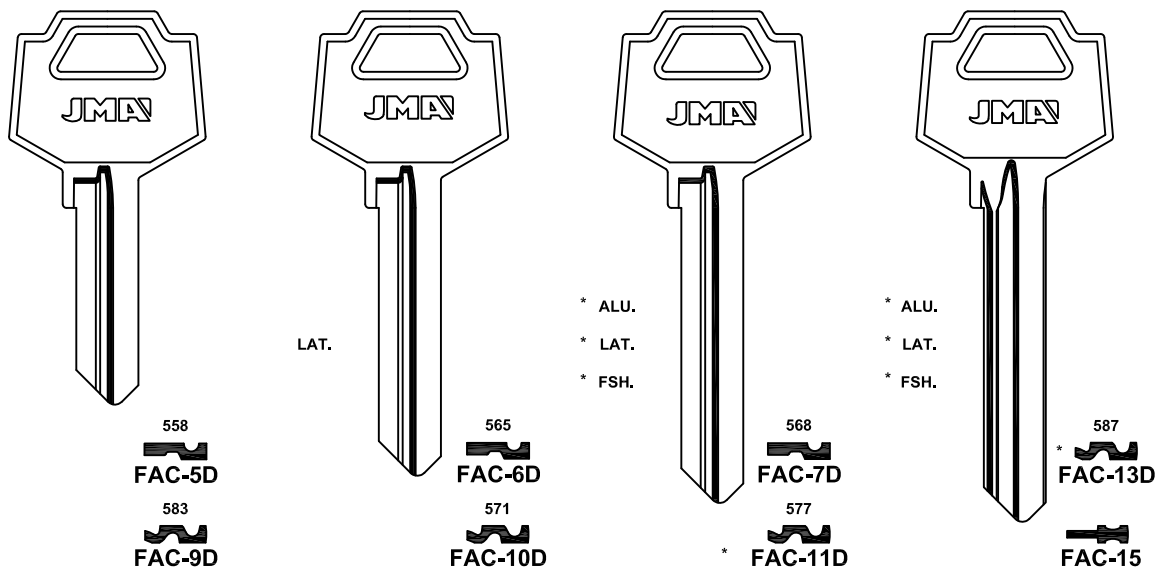

FAC

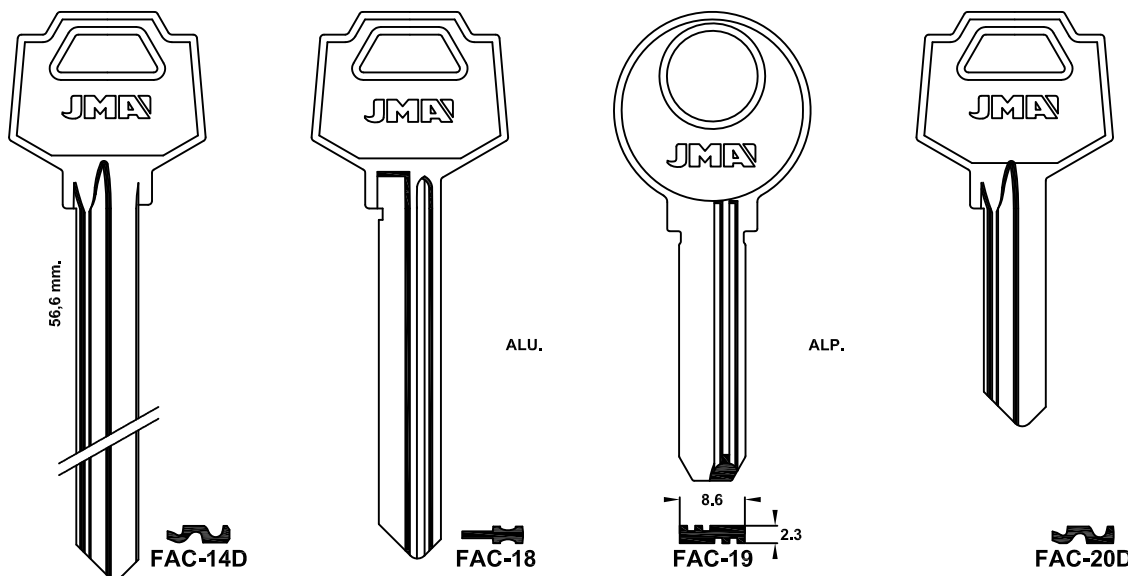

**FAC**

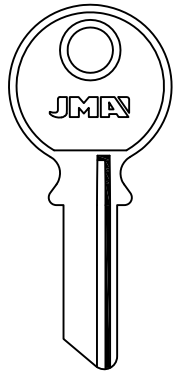

FAC-21

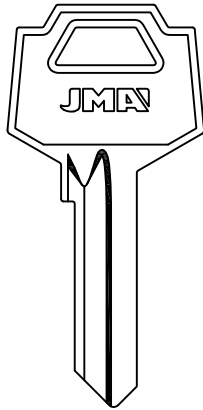

FAC-21D

FAC-22D

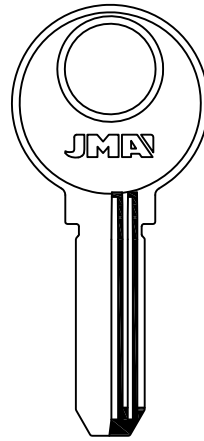

LAT.

FAC-23  
8.9 2.35

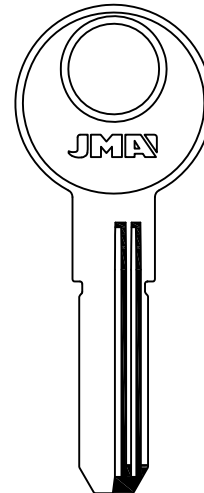

LAT.

FAC-24  
8.9 2.35

**PARA-FOR:**

- FAC (E)
- FAINER (P)
- FALCON (USA)
- FAMA (BR)
- FANA (D)
- FAS (S)
- FASEM (I)
- FAVOUR (DZ)

**FAINER**

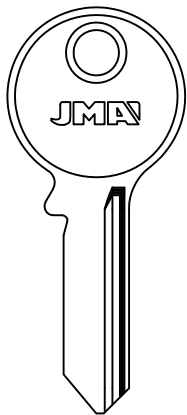

FAIN-1

SIL

**FALCON**

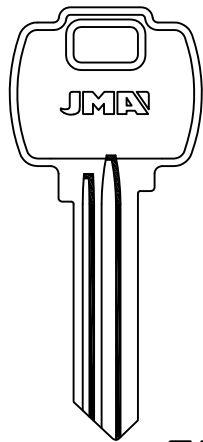

LAT.

FAL-1D

FAL-2D

WEISER

**FAMA**

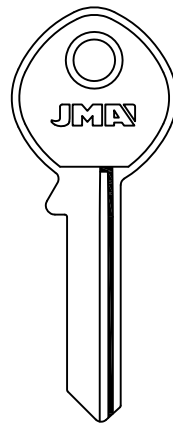

FAM-1

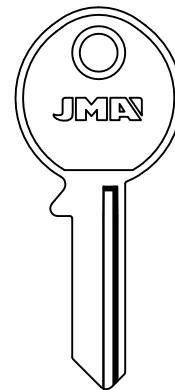

FAM-2

**FANA**

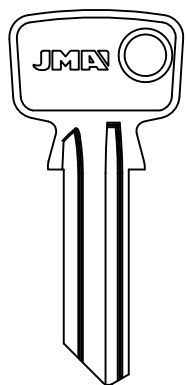

FAN-1

FAN-1D

**FAS**

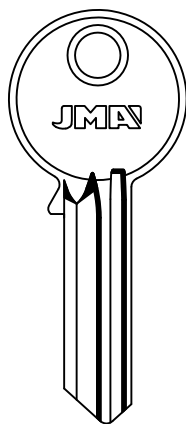

FA-1

FA-1D

**FASEM**

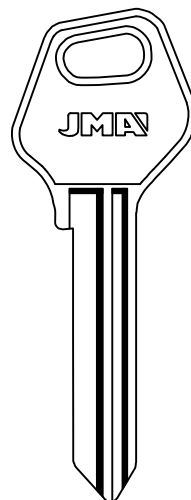

FAS-1

**FAVOUR**

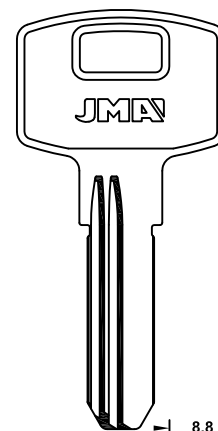

LAT.

FAV-1D  
8,8 2,35











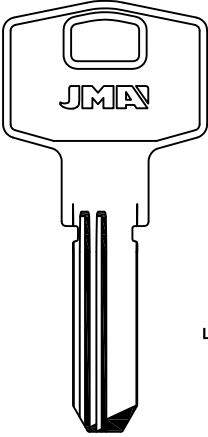
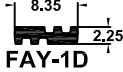
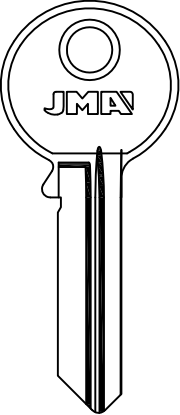

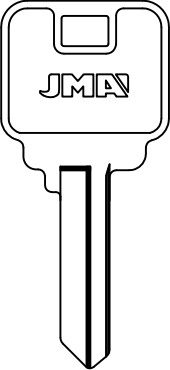

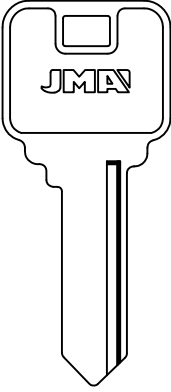

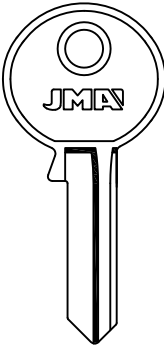

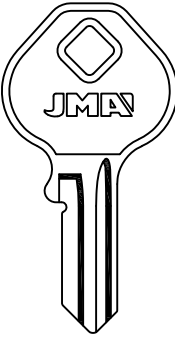

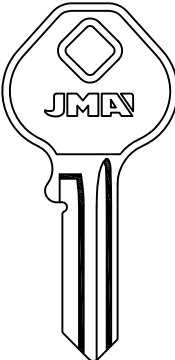

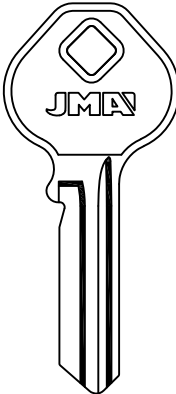

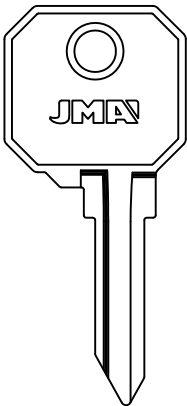

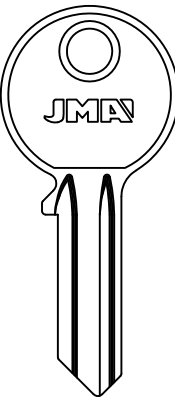
FAV-2

TEICOCIL

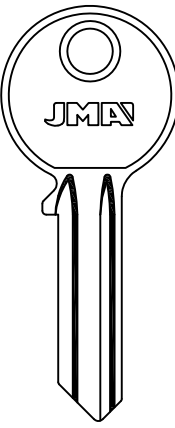

**PARA-FOR:**

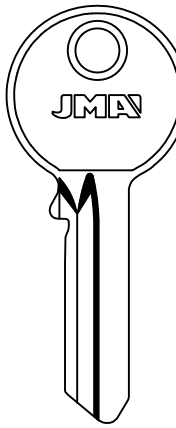
- FAYN (RC)
- FCV (D)
- FECHADURA (BR)
- FEDERAL (USA)
- FERONERIA (RU)
- F.F. (I)

	FAYN	FCV	FECHADURA	
	 <p>LAT.</p>  <p>FAYN-1D</p>	  <p>FV-1D</p>	  <p>FEC-1D</p>	  <p>FEC-2</p> <p>STAM</p>
	FECHADURA	FEDERAL		
	  <p>FEC-3D</p> <p>STAM</p>	  <p>FED-1</p>	  <p>FED-2</p>	  <p>FED-3</p>
	FERONERIA	F.F.		
	  <p>FER-1</p>	 <p>0 AL 7</p>  <p>FF-1</p>  <p>FF-1D</p>  <p>FF-3</p> <p>GUARDIAN</p>	 <p>0 AL 7</p>  <p>FF-2</p>  <p>FF-2D</p>  <p>FF-10D</p> <p>GUARDIAN</p>	  <p>FF-5D</p>



F.F.

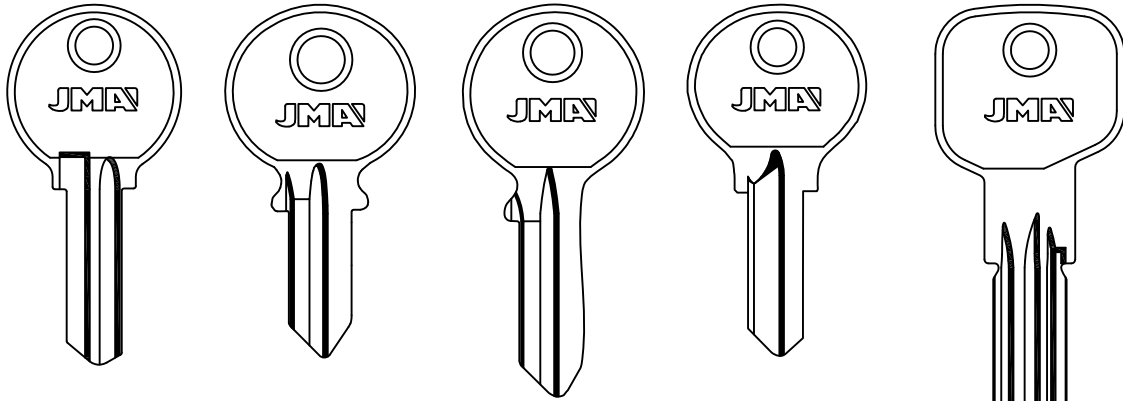

FF-6



FF-11



FF-7D



FF-8D



FF-9D



FF-13

LAT.

PARA-FOR:

F.F. (I)

FIC LOCKS  
(USA)

FICHET (F)

FIC LOCKS

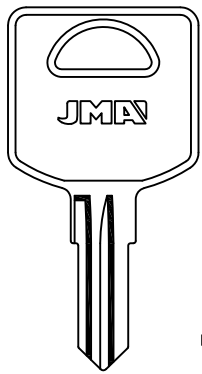

LAT.



FCS-1D

FICHET

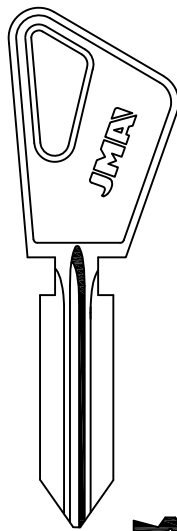

LAT.



FIC-1



FIC-2

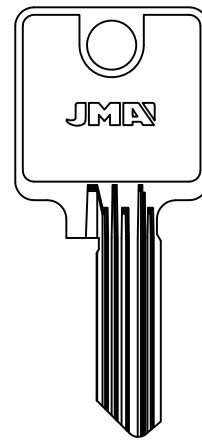
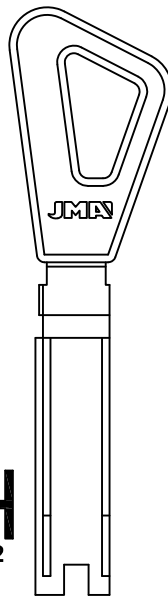

FIC-5

SURFINOR

FICHET

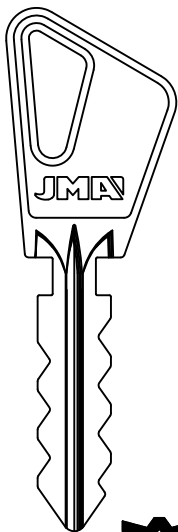

FIC-7

SURFINOR

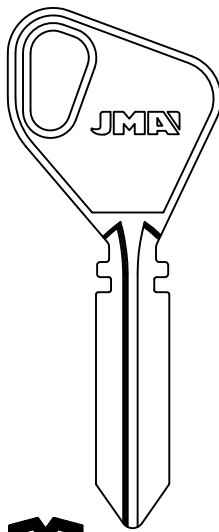

FIC-8

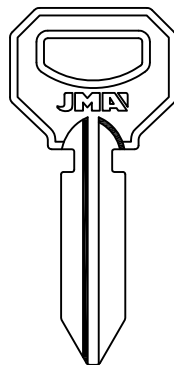

FIC-9

TECNOR

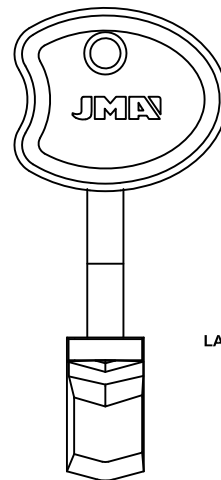











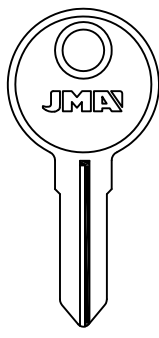

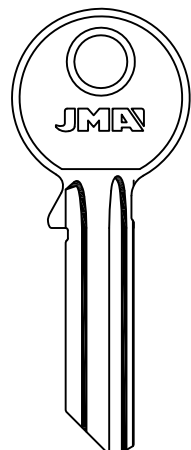

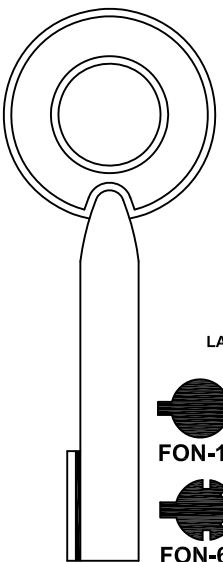

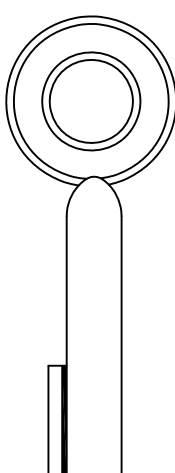
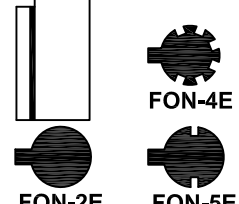
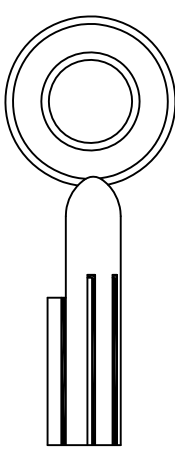

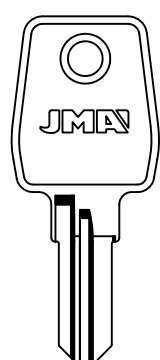
FIC-18

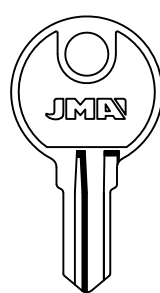
LAT.

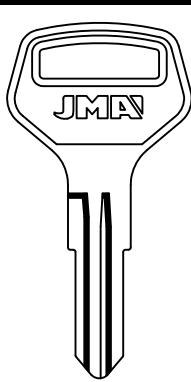
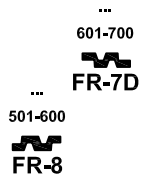
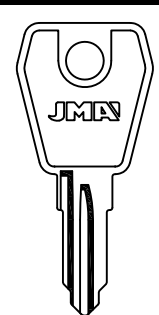

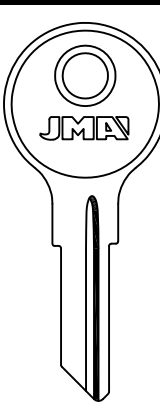
**PARA-FOR:**

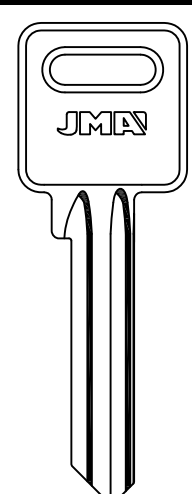
- FIST (I)
- FLORA (D)
- FONTAINE (F)
- FORT (F)
- FORTE (YV)

FIST	FLORA	FONTAINE	
  <b>FIS-1D</b>	  <b>FLO-1 FLO-1D</b> <small>FLOHR-NB-NORDWEST-SUKI</small>	  <small>LAT.</small> <b>FON-1E FON-6E</b>	
FONTAINE		FORT	
  <b>FON-2E FON-4E FON-5E</b> <small>PROGRES</small>	  <b>FON-3E</b> <small>LAT.</small>	  <b>FR-1D</b> <small>DAD</small>	  <b>FR-4</b>
FORT			FORTE
  <small>...</small> <b>FR-7D</b> <small>...</small> <b>FR-8</b> <small>501-600</small> <b>ARREGUI</b>	  <b>FR-9D</b> <small>FG</small> <b>ABUS-SECURITAL</b>	  <b>FR-11D</b>	  <b>FTE-1 FTE-1D</b>





**PARA-FOR:**

FORTIS (E)

FRIPA (D)

FTH (F)

**FORTIS**

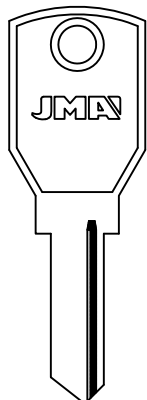

 FORTIS-21

**FRIPA**

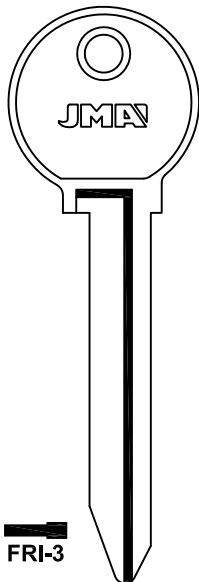

 FRI-3

**FTH**

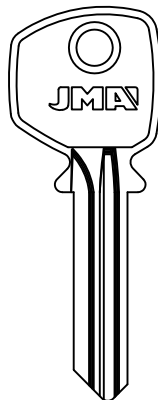

 FTH-1

 FTH-1D

 FTH-8

 FTH-8D

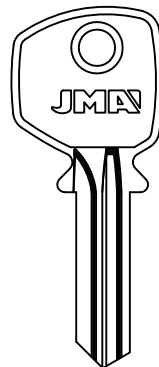

 FTH-2

**FTH**

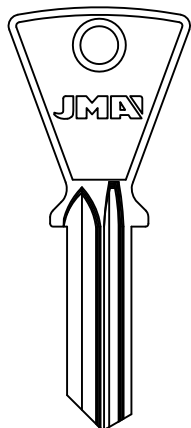

 FTH-3

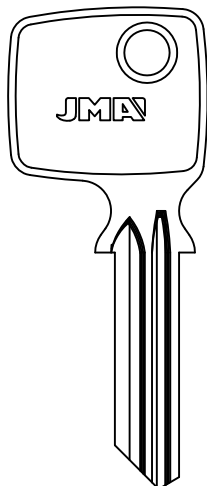

 FTH-4

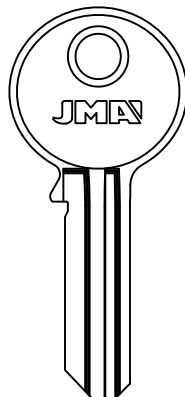

.....A 1 AL 9  
 FTH-5

 FTH-22

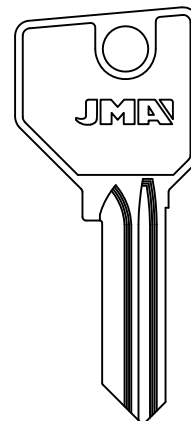

 FTH-6

**FTH**

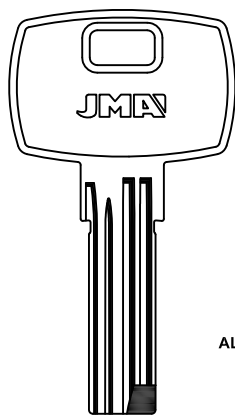

ALP.

 FTH-7

CODEM-TOVER-YALTRES

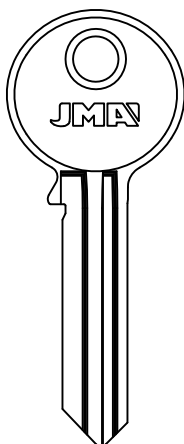

.....A 1 AL 9  
 FTH-9

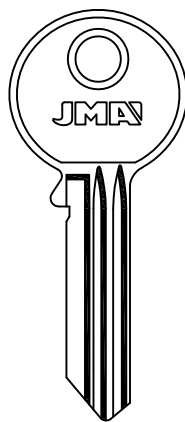

 FTH-10

 FTH-21

CF-CIB-4FAM-JL-NICO-PROBAT  
CIBC-CITY-SUF

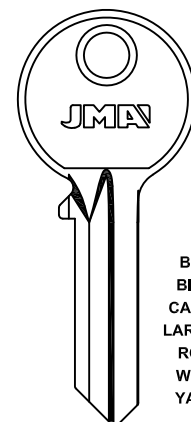

BKS  
BIRD  
CARAT  
LAREDO  
ROC  
WOC  
YALE

.....0 AL 9  
 FTH-11D



PARA-FOR:

FTH (F)

FTH

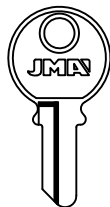

FTH-12D

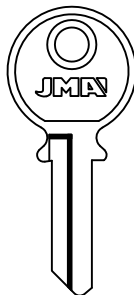

FTH-13D

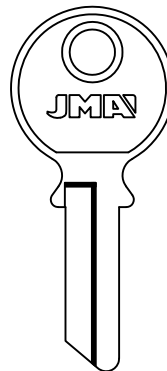

FTH-14D

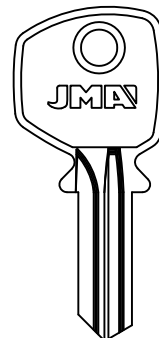

FTH-15

FTH

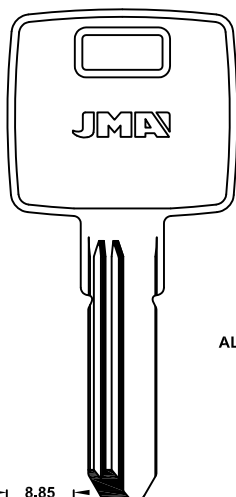

FTH-16

IFAM-KARO

ALP.

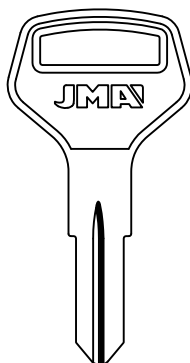

FTH-17D

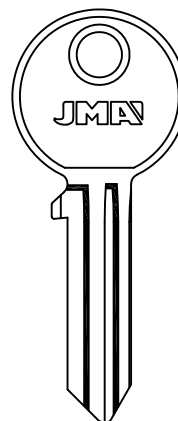

FTH-18

.....A 1 AL 9

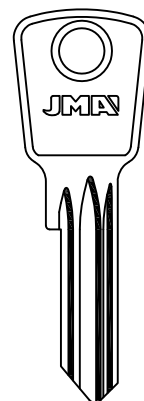

FTH-19

FEDERAL

FTH

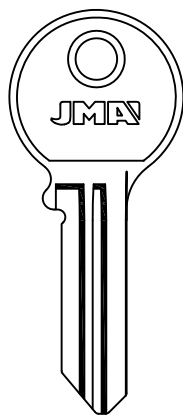

FTH-20D

HERACLES

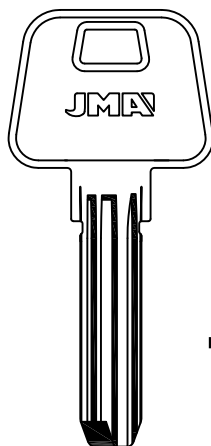

FTH-23

ATLANTIC

LAT.

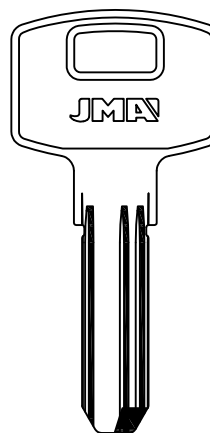

FTH-25

ATLANTIC

LAT.

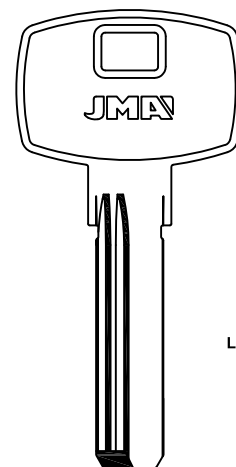

FTH-26D

SP

LAT.



**FTH**

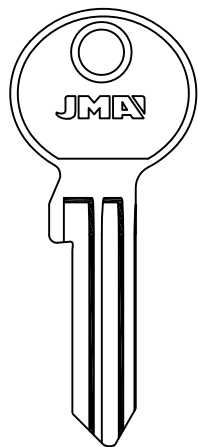

FTH-27

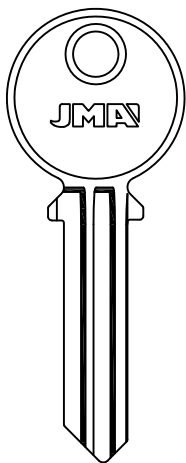

FTH-28

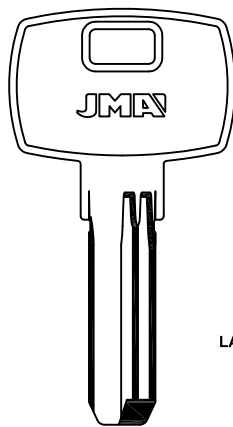

FTH-29

LAT.

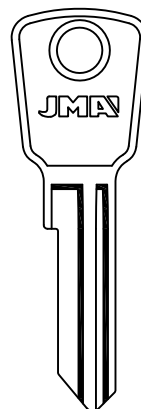

FTH-31

FEDERAL

**PARA-FOR:**

- FTH (F)
- GABON (F)
- GAMMET (PL)
- GATO (COL)
- GBZ (I)
- GE GE (A)

**GABON**

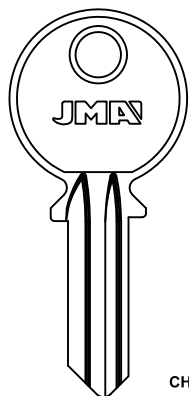

GAB-1I

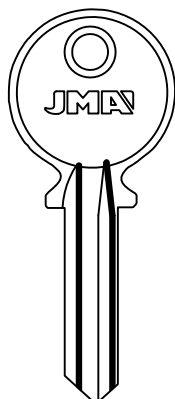

GAB-1D

CHG  
GALLUS  
MAXIGARD  
PICARDIE  
SOS  
WINNER

GAB-2  
CHG-GALLUS-MAXIGARD  
PICARDIE-SOS-WINNER

**GAMMET**

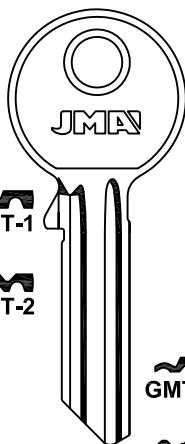

GMT-1

GMT-2

GMT-3D

GMT-4D

GMT-5D

EXPRES

**GATO**

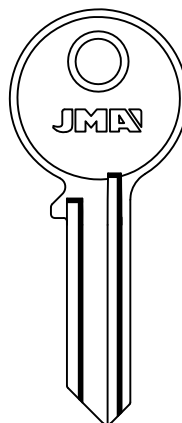

GAT-1

**GATO**

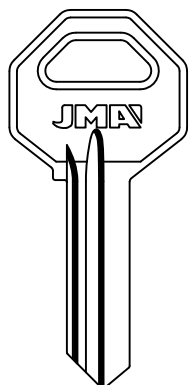

GAT-2D

LAT.

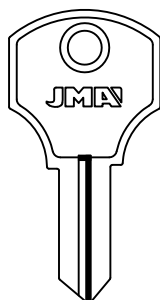

GAT-3D

LAT.

**GBZ**

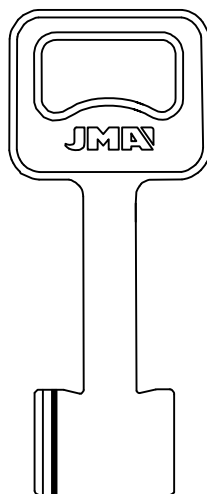

GBZ-1

LAT.

**GE GE**

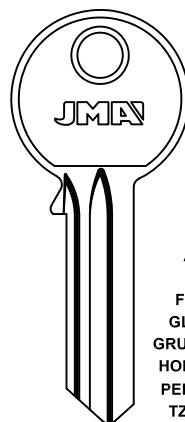

GE-2

ABUS  
FLIK  
FULLEX  
GLOSTAL  
GRUNDMANN  
HOHRMANN  
PEROHAUS  
TZAFRER

GE-1D



**PARA-FOR:**

GE GE (A)

GEBA (D)

GERA (D)

**GE GE**

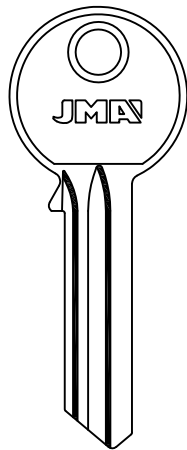

1.....  
500001-735807



ALFA-FINSTRAL

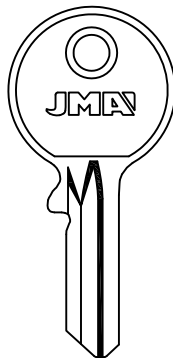

X....1001-1875  
E...00-576



LABOFA-PEROHAUS

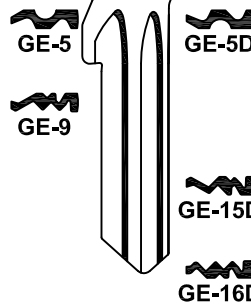
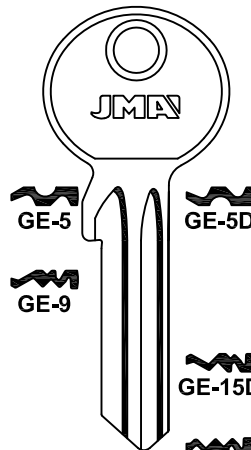

PEROHAUS

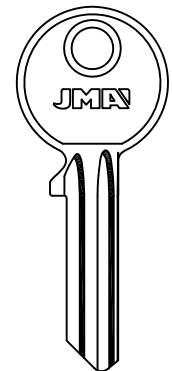

PEROHAUS



PEROHAUS

**GE GE**

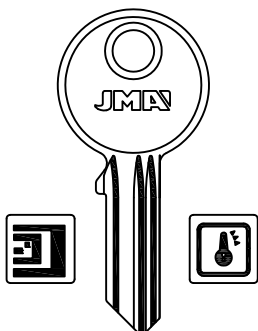

M35 Z....  
20655-21806



M25 Z....  
9135-10286



GEBA

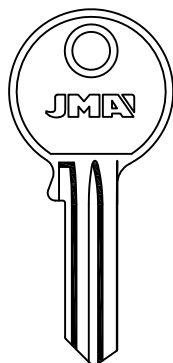

GEBA

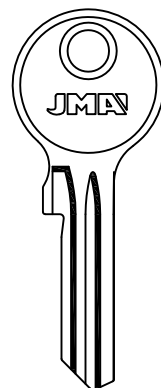

GERA

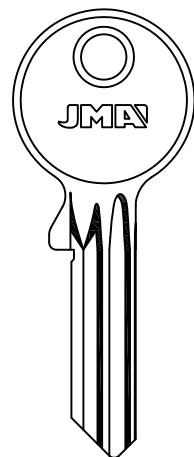

GERA



GERA

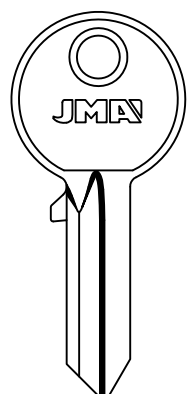

GERA

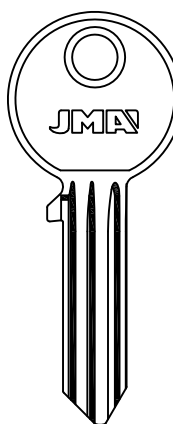

GERA

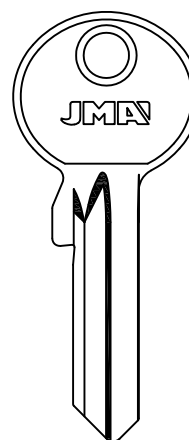

GERA

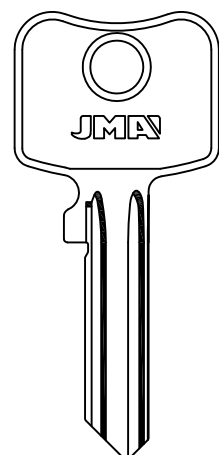

GERA



## GERA

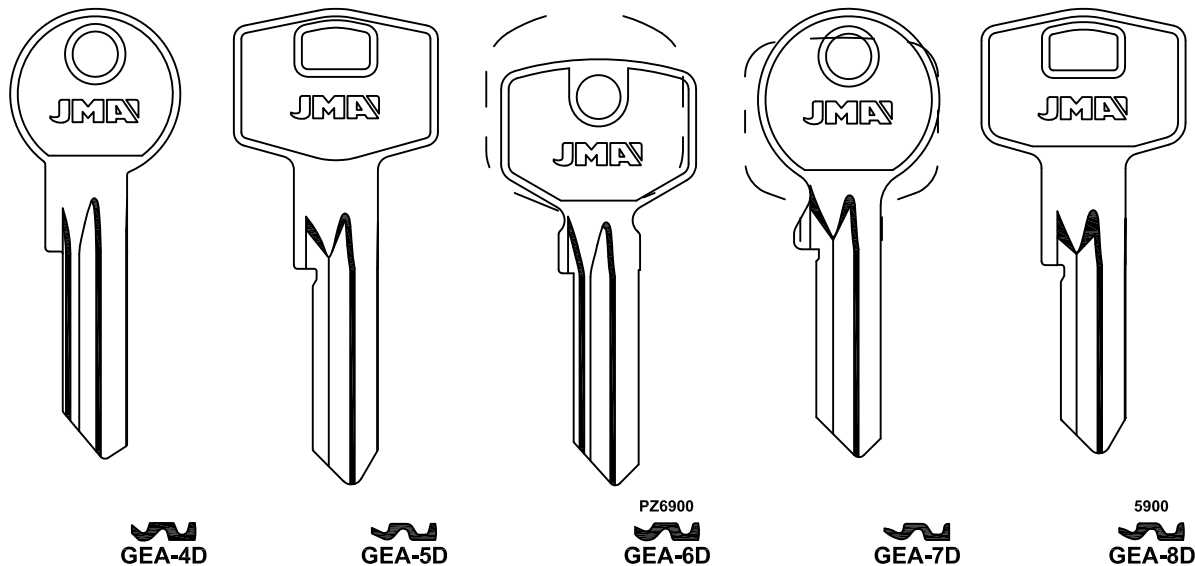

ROTO

## PARA-FOR:

- GERA (D)
- GERDA (PL)
- GIBBONS (GB)
- GIUSSANI (I)

## GERDA

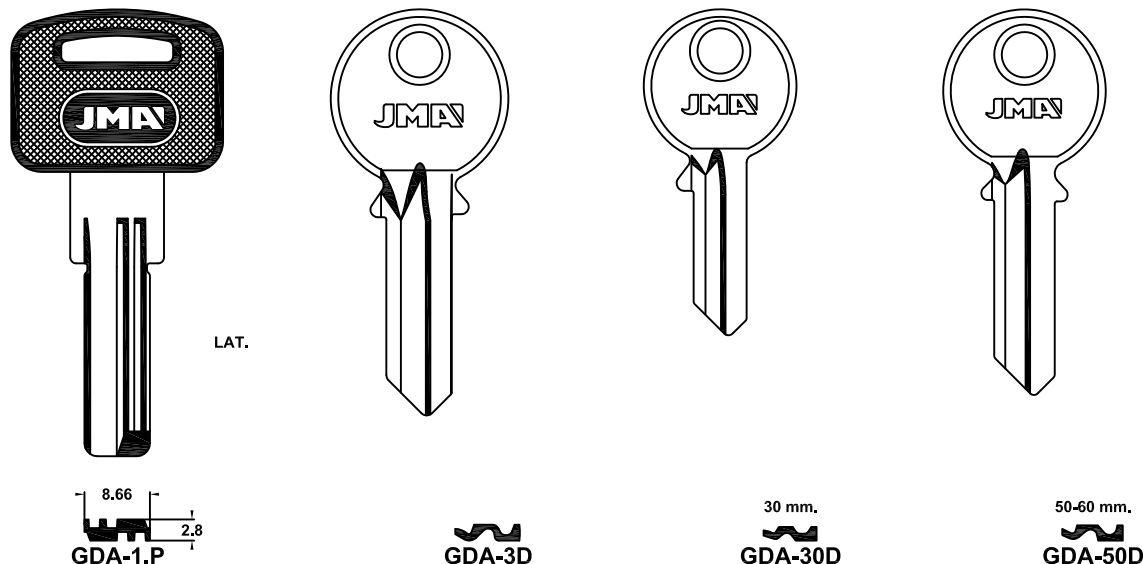

EUROPROFIL

EUROPROFIL

### GERDA

### GIBBONS

### GIUSSANI

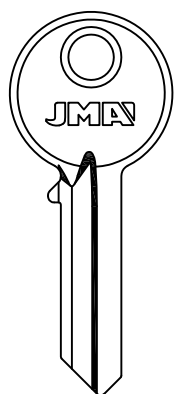

GDA-60D

EUROPROFIL

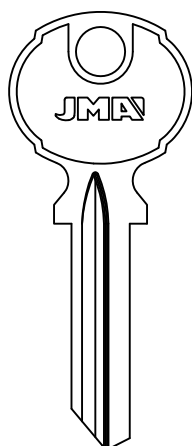

GIB-1D

WILLENHALL

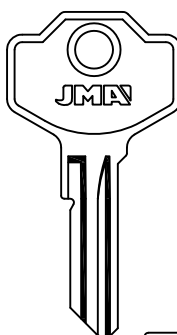

9001-9741  
3001-3480

GIU-1

3001-3480

GIU-2

SIMECA



GIU-1D

GIU-2D

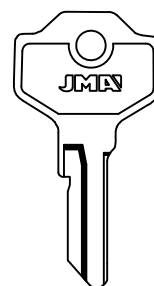

GIU-3D

OAL-LUME

**JMA**®







Copyright by Alejandro Altuna S.A. 2014



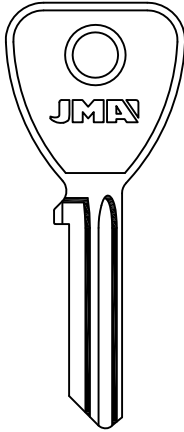
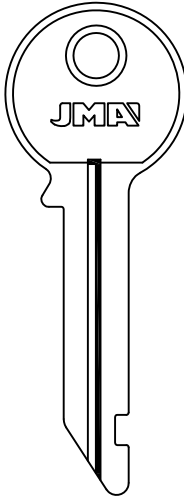
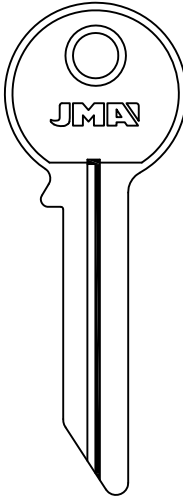
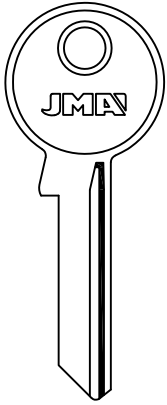







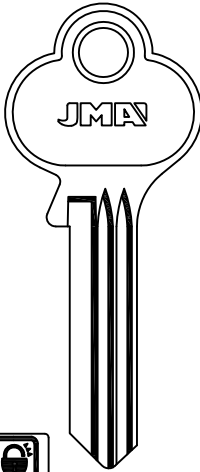
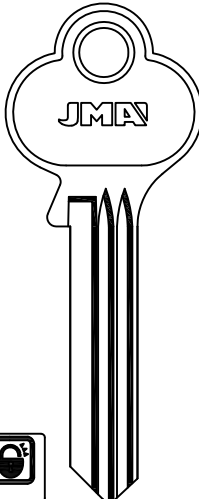
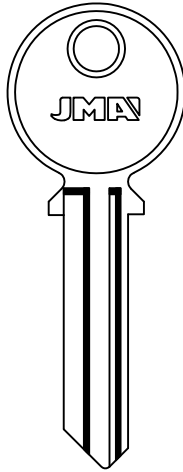
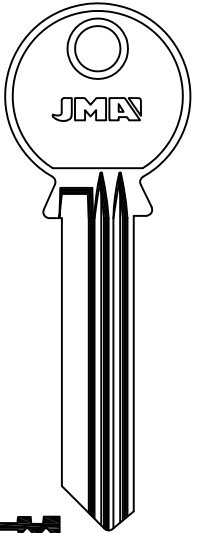

ATENCIÓN: Concerniente a las marcas y denominaciones comerciales ver nota en índice.  
ATTENTION: Concerning the marks and commercial denominations see note in index.  
ATTENTION: Concernant les marques et denominations commerciales voir la note dans l'index.  
ACHTUNG: Beziehen auf die marke und handelsname sehen sie die notiz im index.

**PARA-FOR:**







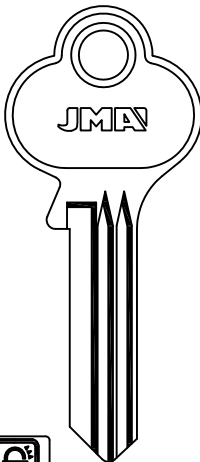
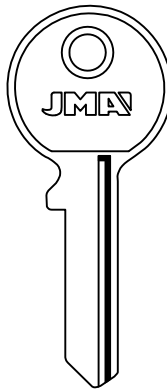
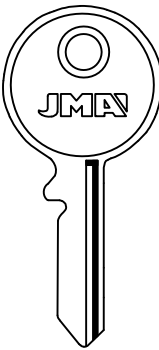
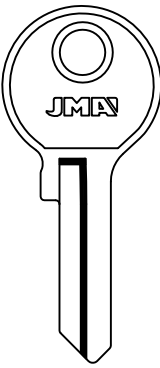

- GIUSSANI (I)
- GLAZIEV (RUS)
- GLOBE (RC)

GIUSSANI	GLAZIEV		GLOBE
			
			 

**GLOBE**

			
 	 	 	
			
LARK		MIAN-FORCE	

**GLOBE**

			
 	 	 	
			
GOLD DOOR			



# GLOBE

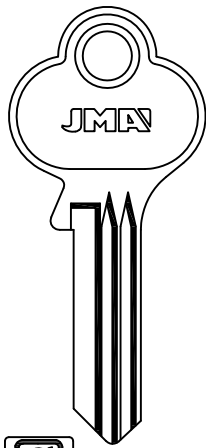

GLO-10

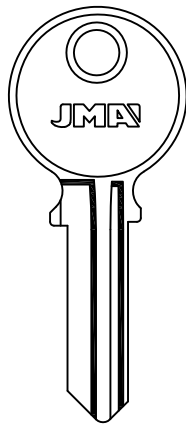

GLO-11

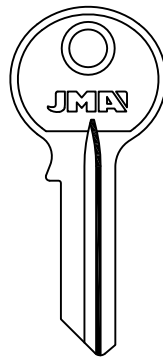

GLO-12D

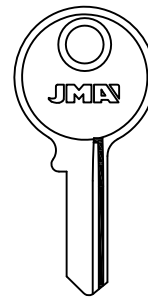

GLO-22 GLO-22D

GOLD DOOR

# PARA-FOR:

- GLOBE (RC)
- GODREJ (IND)
- GR (RC)
- GTV (D)
- GUARD (HK)

## GLOBE

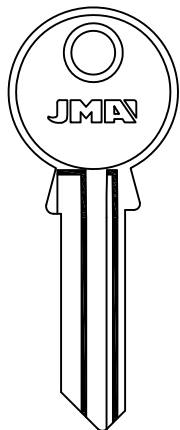

GLO-23 GLO-23D

ANLO-LUCO

## GODREJ

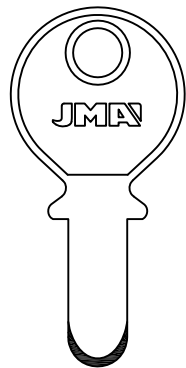

GOD-1

ALP.

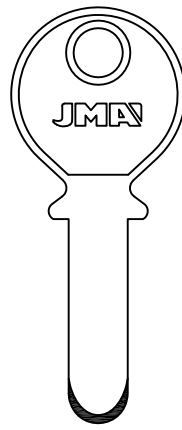

GOD-2

ALP.

## GR

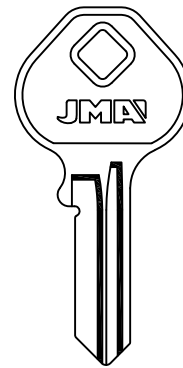

GRG-1

## GTV

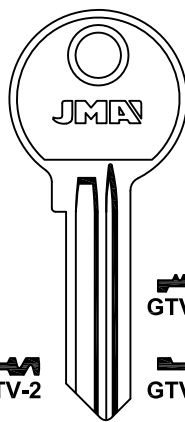

GTV-1D

GTV-2

GTV-2D

GTV-3D

GTV-4D

TIEFENTHAL

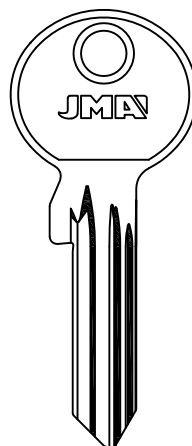

GTV-5D

JOWIL-TIEFENTHAL

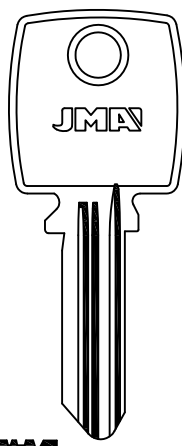

GTV-11

GTV-10

TIEFENTHAL

LAT.

## GUARD

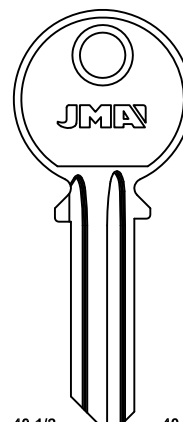

GUA-1

GUA-1D

GUA-2

GUA-2D











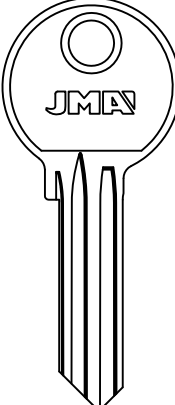
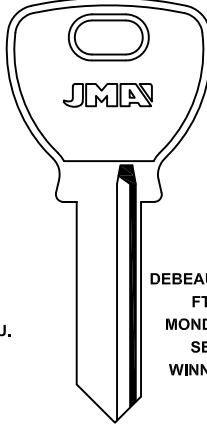
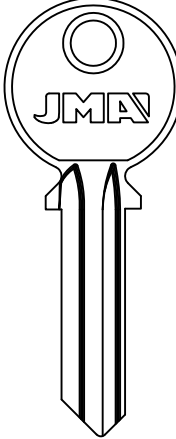
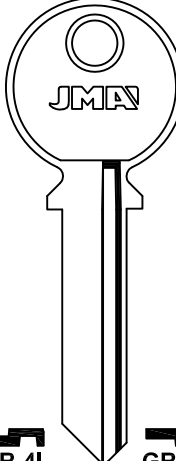











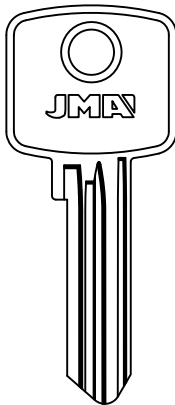
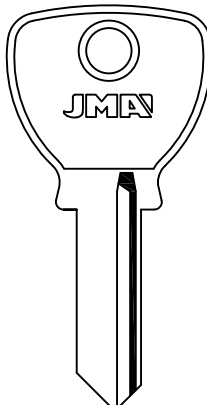
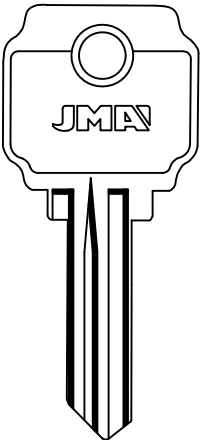
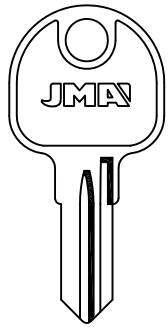



FAB



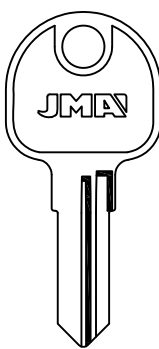
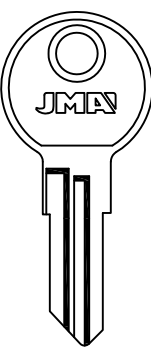
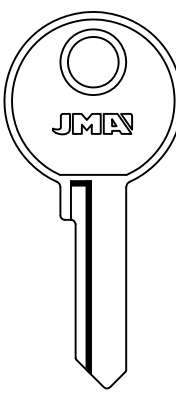
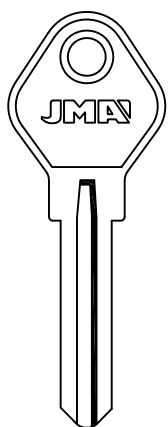







**PARA-FOR:**

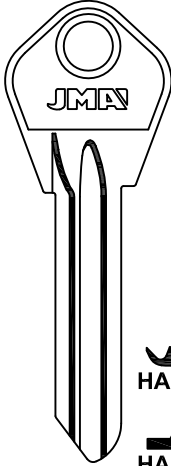
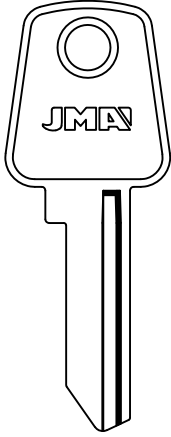
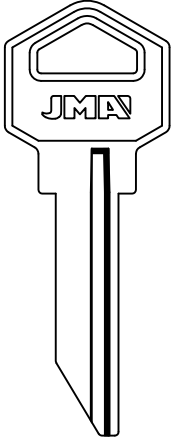
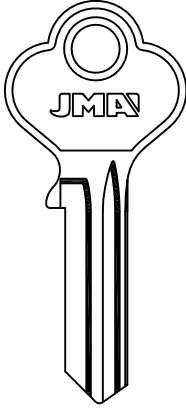







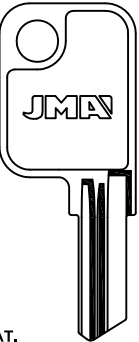
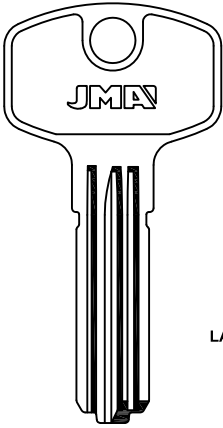
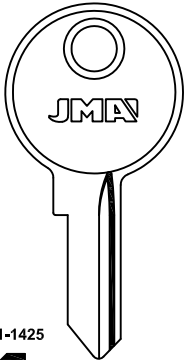
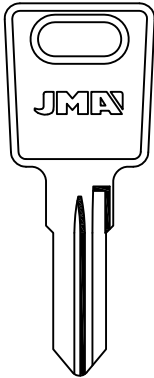

- GUARD (HK)
- GUERVILLE R. (F)
- HÄFELE (D)
- HAGA (RC)
- HALLE (USA)



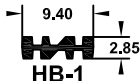

GUARD	GUERVILLE R.		
	 <p>ALU.</p> <p>DEBEAURAIN FT MONDIAL SE WINNER</p>		
 GUA-3  GUA-3D	 GR-1I  GR-1D  GR-2I  GR-2D	 GR-3I  GR-3D PERRIER	 GR-4I  GR-4D  GR-5I  GR-5D
GUERVILLE R.		HÄFELE	
			
 GR-6  GR-6D	 GR-7  GR-7D	 GR-8 MONDIAL	 HAF-1  HAF-1D  HAF-4
HÄFELE		HAGA	HALLE
			
 HAF-2  HAF-2D	 HAF-3D	 HAG-1D	 HAL-1

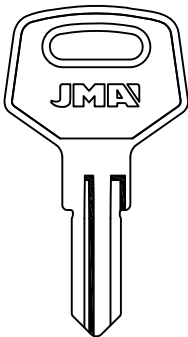
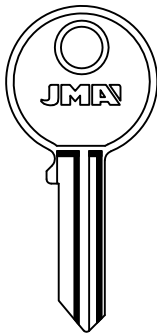
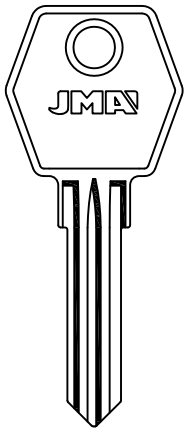
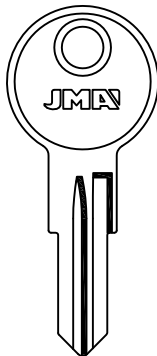

HARKOV			HARLOC
			
 HAK-1D			
 HAK-2D			
 HAK-5	 HAK-3	 HAK-4	 HAR-1
			DNS-EAGLE-LORI

**PARA-FOR:**  
HARKOV (RUS)  
HARLOC (USA)  
HAYWORTH (USA)  
HB (I)  
HEKNA (D)  
HELIX (RC)  
HENDERSON (USA)  
HERME (RC)











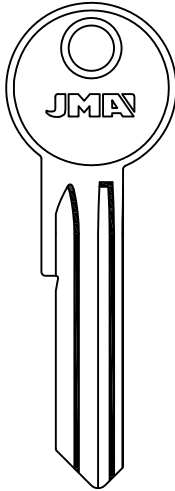
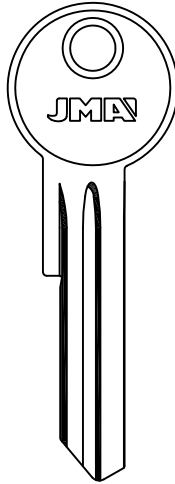
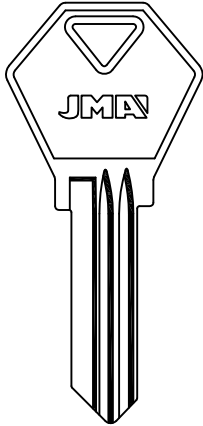
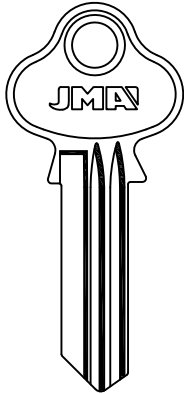



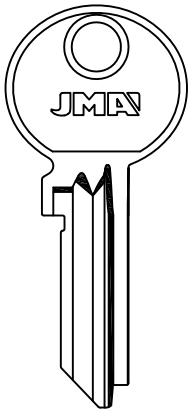
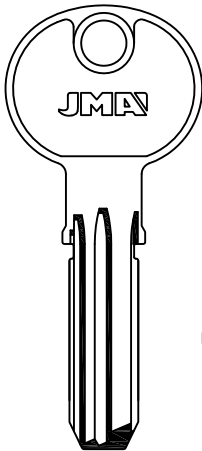
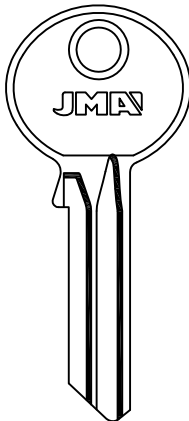
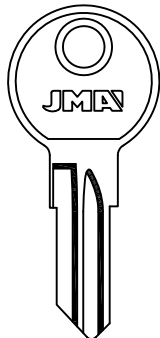

HAYWORTH	HB	HEKNA	
			
LAT.	LAT.	....1001-1425	
 HAW-1D		 HEK-1	
 HAW-2D		 HEK-2	
 HAW-3D	 HB-1	 HEK-3	 HEK-4
 HAW-4D	LEGALLAIS	METALCASTELLI-RAUCO-REGENT	METALCASTELLI-RAUCO-REGENT

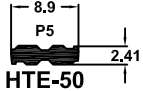
HELIX	HENDERSON		HERME
			
	R 008-254		
 HEL-1	 HEN-1	 HEN-2	 HRM-1
	HEN-1D		
	REGENT		

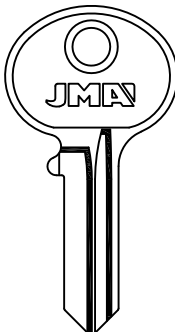
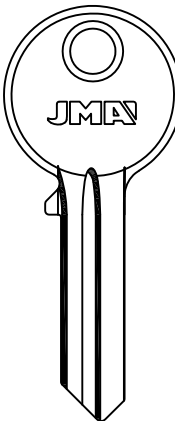
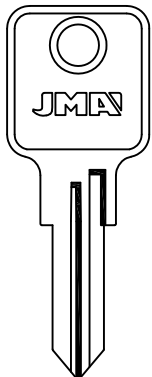
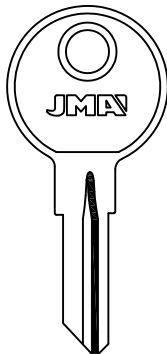
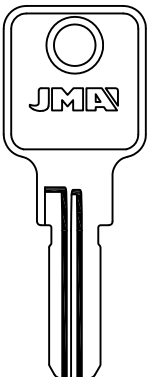

**PARA-FOR:**

- HOBES (RCZ)
- HORSE (RC)
- HTEC (E)
- HTV (GB)
- HUDSON (USA)
- HUNIT (I)
- HUWIL (D)

HOBES		HORSE		
				
 HOB-1	 HOB-2D	 HOR-1	 HOR-2	 HOR-2D
HTEC		HTV	HUDSON	
				
 HTE-1D	 8.9 P5 2.41 HTE-50 THT	 07 HT-1 VAUGHN	 HUD-2D	
HUDSON	HUNIT	HUWIL		
				
 HUD-3	 HUN-1D FTH	 HUW-1	 HUW-2	 HUW-3D
		<p>W 3000-4000 A 3001-4000 V</p> <p>STRAFOR-STEELCASE</p> <p>CEKA-HÄFELE-MAUSER-SCHÄRF</p>		



HUWIL	IBEAR	ICA	
N 0005-1878 N 2001-2204  HUW-N TECNO	 IB-1  IB-2 ICA-SERRALLER	 ICA-1	 ICA-4IP

**PARA-FOR:**

- HUWIL (D)
- IBEAR (E)
- ICA (E)
- ICSA (I)
- IFAM (E)

ICA	ICSA		IFAM
 ICA-5IP	 ICS-1D ORLANDO-REMO-ZANI	 ICS-2D	LAT.  IF-1 JOMA

IFAM			
ALP.  IF-2	ALP.  IF-3.P	ALP.  IF-4	 IF-5



**PARA-FOR:**

IFAM (E)

IGS (F)

IKON (D)

**IFAM**

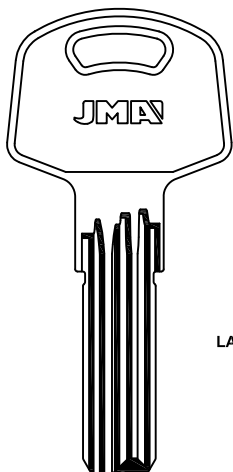

LAT.

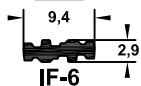

IF-6

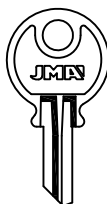

IF-15

TEM

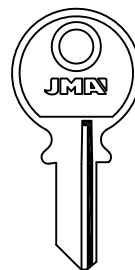

IF-120

ABUS-JOMA-TEM-TESA

IF-D20

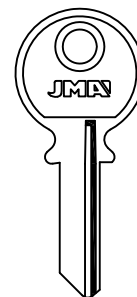

IF-125

\* IF-D25

BATU-FADE-JOMA  
GUARD-RIPA-TEM

**IFAM**

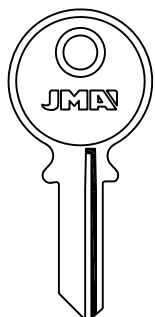

IF-130

JOMA



IF-D30

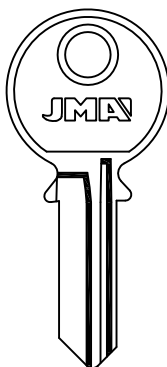

LAT.  
ALU.



IF-140

RIPA

IF-35

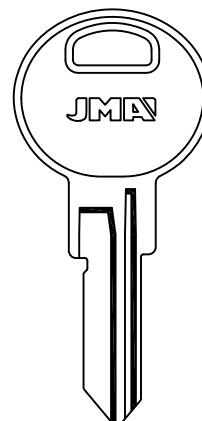

IF-140L

RIPA

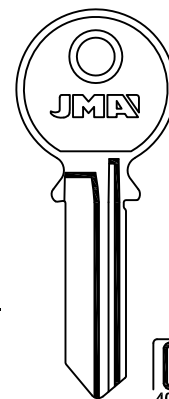

\* ALU.  
\* LAT.  
\* FSH.



IF-150

\*50\*

IF-151



\* IF-45/55

**IFAM**

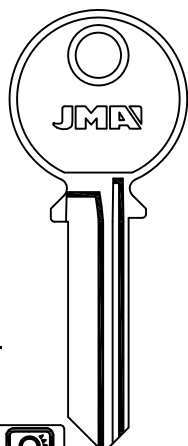

LAT.



IF-160/70

IF-60/70

**IGS**

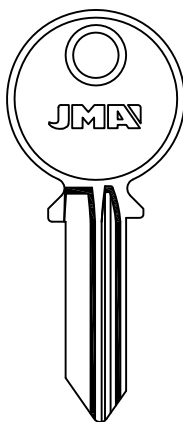

IGS-1

**IKON**

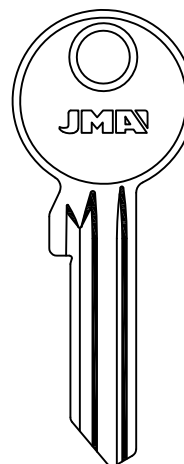

\* LAT.

SN4



ZE-1

SN2



ZE-2

N2



ZE-6

SN3



ZE-1D

SN1



ZE-2D

N1



ZE-6D

M



ZE-9D

SN5



\* ZE-14D

BRUMME-OTIS



# IKON

PARA-FOR:

IKON (D)

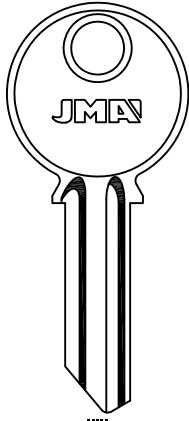

.....  
1 AL 9 AL 0  
A-B-C-D-E-F-G-H-I-L



BRUMME-OTIS

# IKON

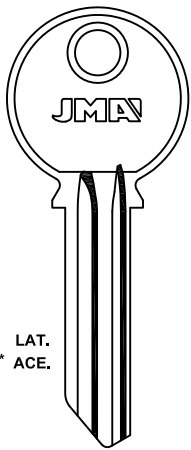

LAT.  
\* ACE.



LAT.



PARA-FOR:

IKON (D)

IKON

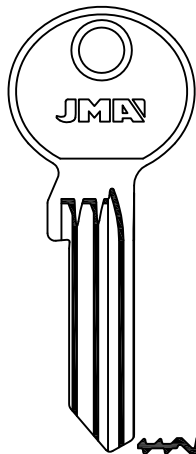

ZE-10D

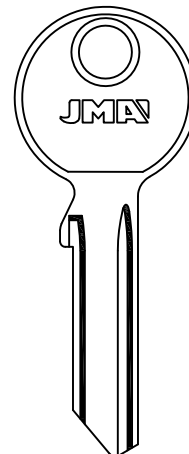

ZE-13

ZE-11D

IKON

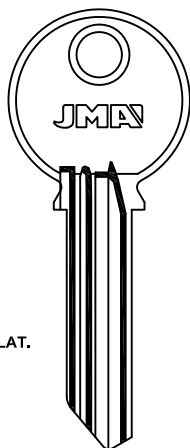

LAT.



ZE-65D



ZE-66D



ZE-67D



ZE-68D



ZE-69D



ZE-110D



ZE-117D



ZE-60D



ZE-61D



ZE-62D



ZE-63D



ZE-64D



ZE-109D



ZE-116D



ZE-55D



ZE-56D



ZE-57D



ZE-58D



ZE-59D



ZE-108D



ZE-115D



ZE-50D



ZE-51D



ZE-52D



ZE-53D



ZE-54D



ZE-107D



ZE-114D



ZE-33D



ZE-34D



ZE-47D



ZE-48D



ZE-49D



ZE-106D



ZE-113D



ZE-28D



ZE-29D



ZE-30D



ZE-31D



ZE-32D



ZE-105D



ZE-112D



ZE-23D



ZE-24D



ZE-25D



ZE-26D



ZE-27D



ZE-70D



ZE-111D



ZE-147D



ZE-146D



ZE-145D



ZE-141D



ZE-136D



ZE-127D



ZE-126D



ZE-125D



ZE-148D

LAT.

PERFIL Z SERIE 400





## IKON

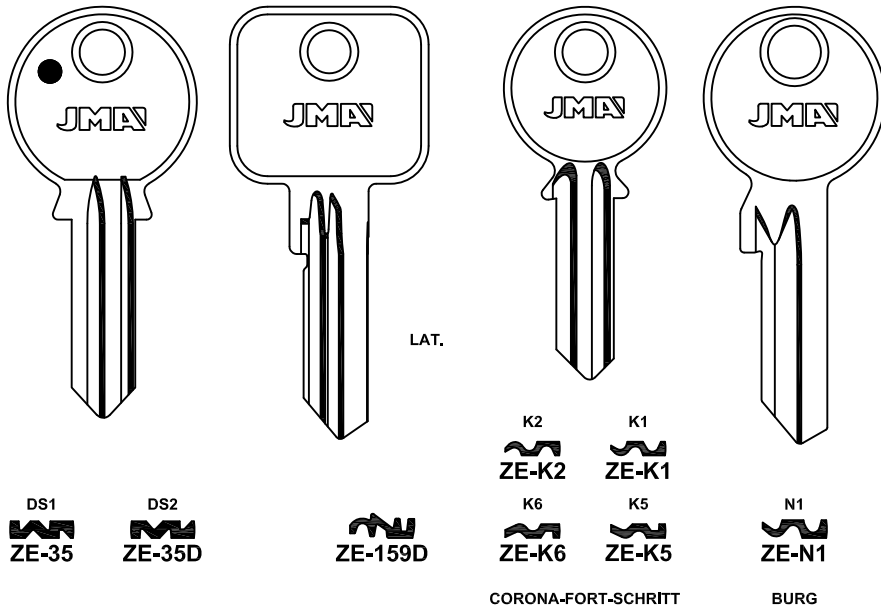

## ILARGI

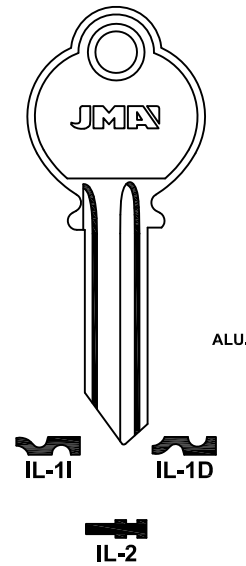

## PARA-FOR:

IKON (D)  
ILARGI (E)  
ILCO (USA)  
ILLINOIS (USA)  
ILS (I)  
IMB (KW)

## ILCO

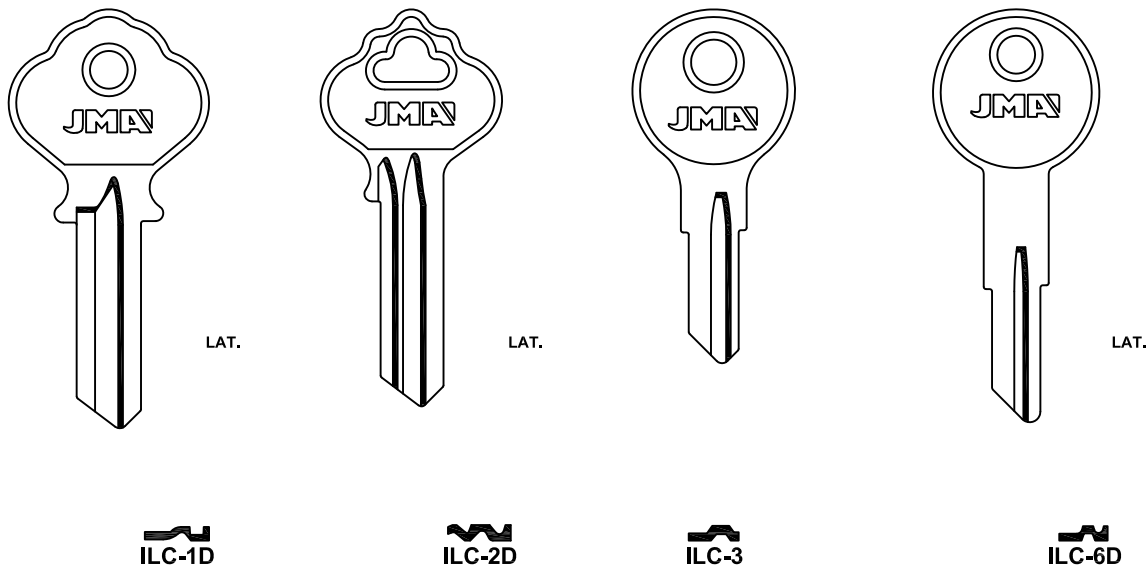

## ILLINOIS

## ILS

## IMB

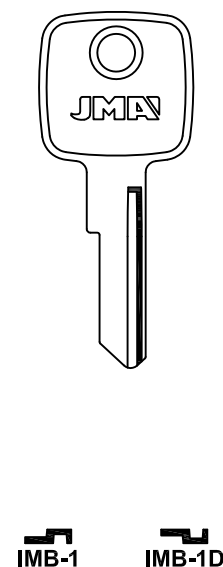
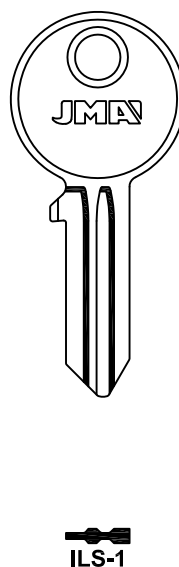
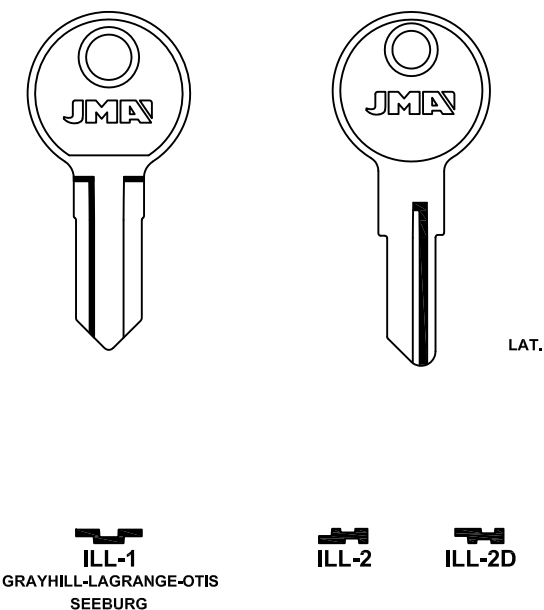

**PARA-FOR:**











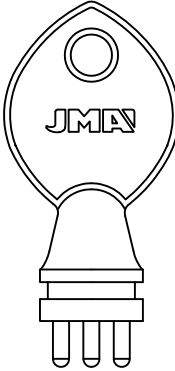
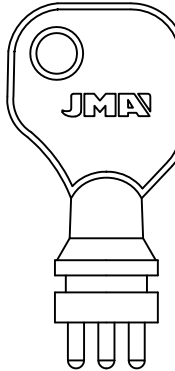

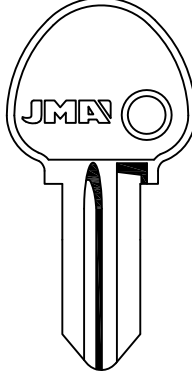

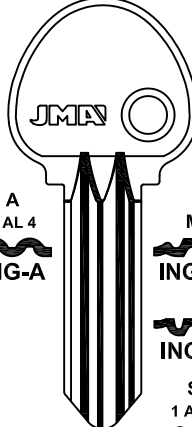





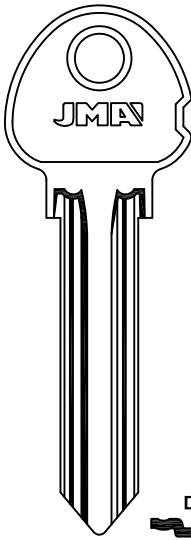

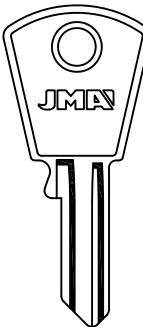

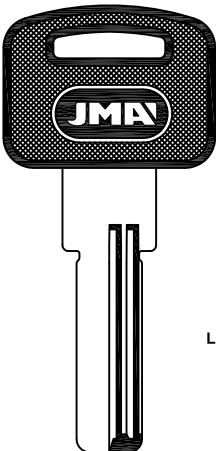
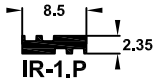
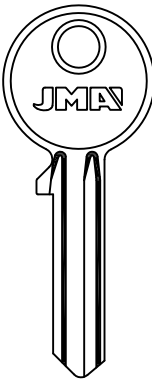

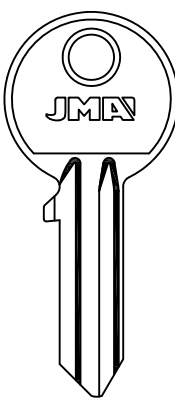

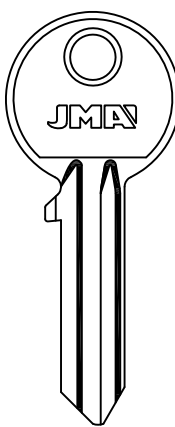

INCECA (E)

INGERSOLL  
(USA)

INT (D)

IR (F)

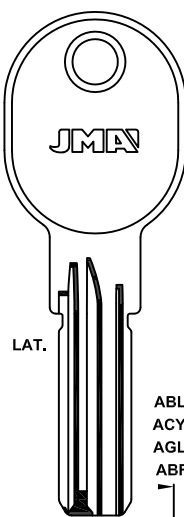
ISEO (I)

INCECA		INGERSOLL	
 <p>LAT.</p>  <p>LAT.</p>  <p>INCE-1E</p>  <p>INCE-2E</p>		 <p>LAT.</p>  <p>ING-6</p>	 <p>LAT.</p>  <p>1 AL 4 ING-A</p>  <p>M ING-M</p>  <p>ING-N</p>  <p>S 1 AL 4</p>  <p>ING-S</p>  <p>W ING-W</p>
INGERSOLL	INT	IR	ISEO
 <p>LAT.</p>  <p>D ING-D</p>	 <p>LAT.</p>  <p>INT-1</p>  <p>INT-1D</p>	 <p>LAT.</p>  <p>8,5 2,35 IR-1,P BYP-IFAM</p>	 <p>LAT.</p>  <p>1 AL 5 IS-1I</p>  <p>IS-1D TESA</p>
ISEO			
 <p>LAT.</p>  <p>IS-2I</p>  <p>IS-2D</p>	 <p>LAT.</p>  <p>IS-3I</p>  <p>F5 * IS-3D</p>	 <p>IS-4</p> <p>....1-2000 Y....1-2000 0 AL 8</p>  <p>IS-5D</p>  <p>IS-7D</p>  <p>IS-8</p>  <p>IS-8D</p>  <p>IS-18D</p>  <p>IS-19D</p>	 <p>LAT.</p>  <p>9,4 R6 2,5 IS-6D</p> <p>MD-VACHETTE</p> <p>ABL.....1-015328 ACY.....1-015328 AGL.....1-015328 ABF.....1-015694</p>



# ISEO

# PARA-FOR:

ISEO (I)

ITO (TR)

IVANA (D)

JARDI (E)

**IS-20**  
LEROY MERLIN  
EAM.....  
9.4  
2.8

**IS-14D**  
MD-VACHETTE  
9.4  
R6  
2.75

**IS-10**  
ATRA  
AAC.....1-015694  
DAA.....1-348933  
9.4  
2.74

**IS-10.P**  
ATRA  
R7  
AAC.....1-015694  
DAA.....1-348933  
9.4  
2.74

**IS-15**  
F3

LAT.

ALP.

# ISEO

# ITO

**IS-16D**

**IS-17D**  
F6  
VBE.....000001-014970  
A/Z A/Z A/Z.....1-48568

**ITO-1D**

**ITO-2D**  
LAT.  
9.2  
2.85

# IVANA

# JARDI

**IV-1**

**IV-2D**

**JAR-1I** **JAR-1D**







**JAR-2I** **JAR-2D**



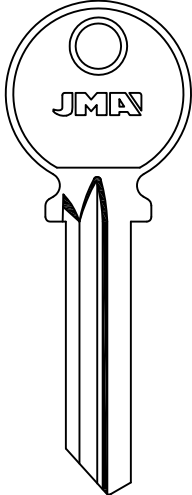
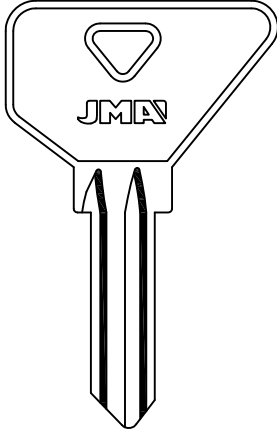
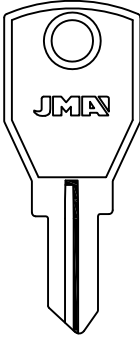
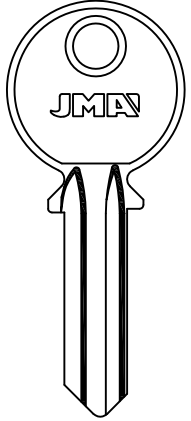



**JAR-3** **JAR-6** **JAR-6D**



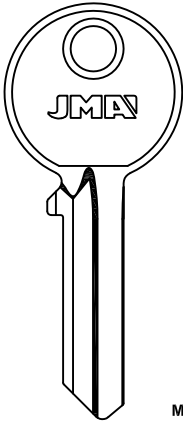
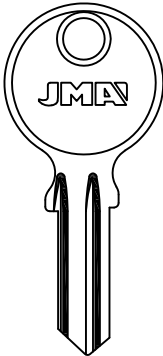
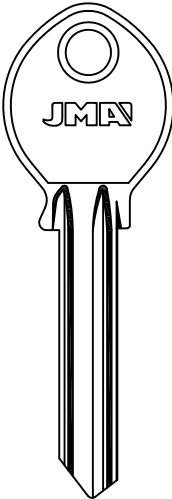
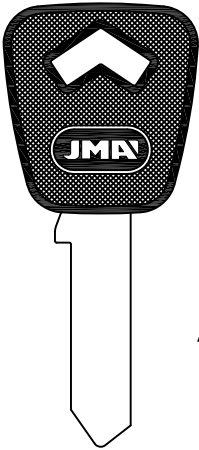



**PARA-FOR:**

- JARDI (E)
- JINLONG (RC)
- JIP (E)
- JIS (E)
- JOMA (E)
- JOVI (E)
- JOWIL (D)

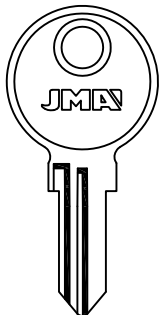
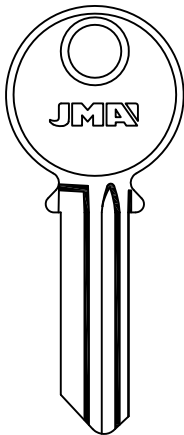
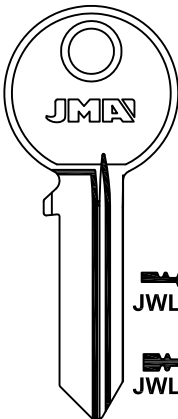
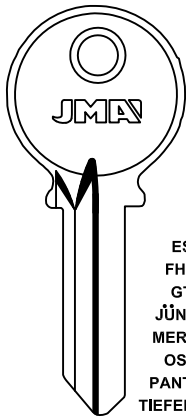
JARDI	JINLONG	JIP
 		
 JAR-4D  JAR-5I  JAR-5D	 JIN-1D	 JIP-1I  JIP-1D

JIS			
			
ALU. LAT. FSH. MTIC.(J)	LAT. ALU.	ALU.	ALP.
 JIS-1D	 JIS-2I	 JIS-3I  JIS-3D	 JIS-4.P

JOMA	JOVI	JOWIL	
			
 JOM-1D	 JO-1	 JWL-9  JWL-9D	ESZ FHÜR GTV JÜNGST MERCUR OSKO PANTHER TIEFENTHAL TRITON VOKO WEPA



## JOWIL

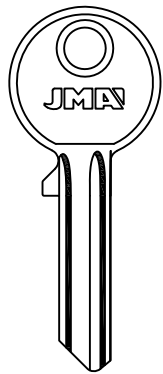

JWL-5

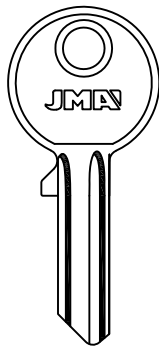

JWL-6

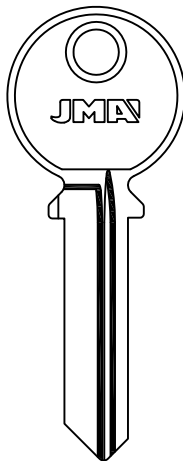

JWL-7D

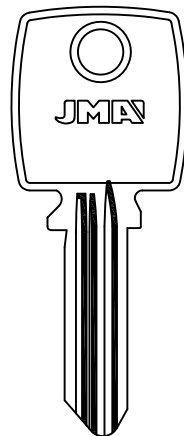

JWL-10D

LAT.

JWL-11D

## PARA-FOR:

JOWIL (D)

JPM (F)

JTF (F)

## JPM

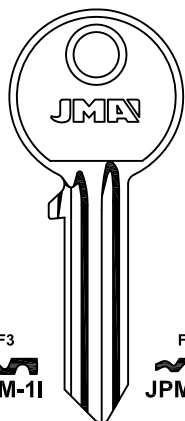

F3  
JPM-1I



F3  
JPM-1D

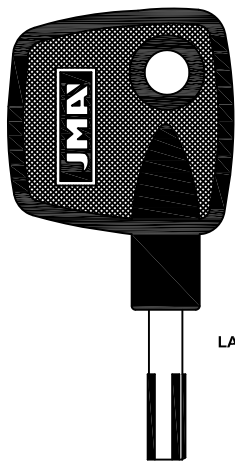

LAT.

JPM-1E

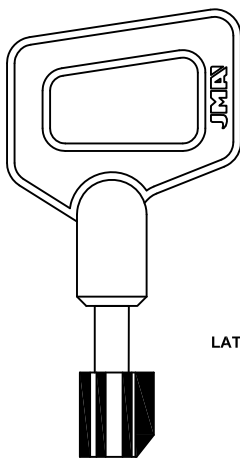

LAT.

JPM-2E

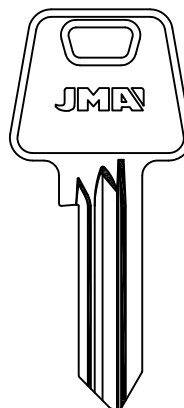

JPM-3D

JPM-2I

JPM-2D

JPM-4

JPM-4D

ABUS

## JPM

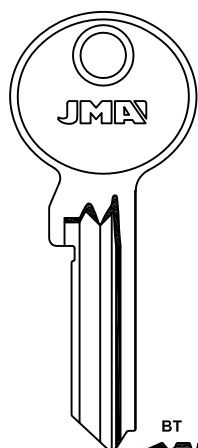

BT  
JPM-10D

BK  
JPM-11D

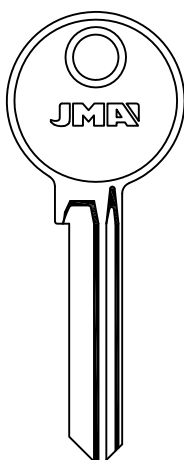

JTF-1I

## JTF

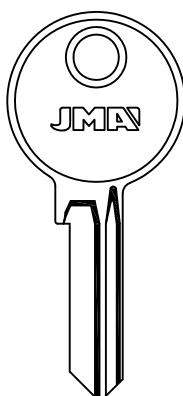

JTF-2I

JTF-3

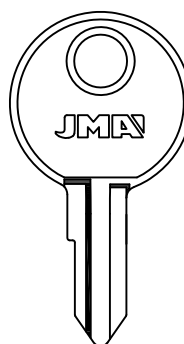

JTF-4



**PARA-FOR:**

- JU-JUNGINGER (D)
- JUNGHEINRICH (D)
- JUNIE (D)
- JUNKUNG (USA)
- JUZU (E)
- JVAL (P)
- KABA (CH)

	JU-JUNGINGER	JUNGHEINRICH	JUNIE	
	    	 	   <p>PEROHAUS-US</p>	    <p>PEROHAUS-US</p>
	JUNIE	JUNKUNG	JUZU	
	      	 <p>LAT.</p> <p>A.MOTORS-BULIT-LION</p>	   <p>ALSO-A.MOTORS-BULIT-LION</p>	 
	JVAL		KABA	
	    <p>P.C.-FEB</p>	      <p>P.C.-FEB</p>	 <p>S15-S16 S17-S18 S53-S58 S59-S61</p>   <p>LÄSBOLAGET</p>	 <p>* ALU. ALP.</p>  <p>GEMINI</p>



# KABA

# PARA-FOR:

KABA (CH)

KABS (D)

KALE (TR)

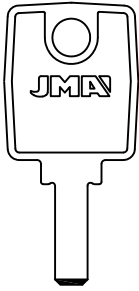

ALP.

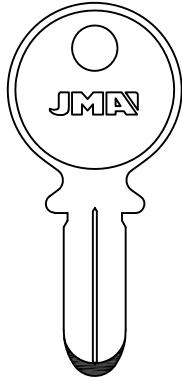

ALP.

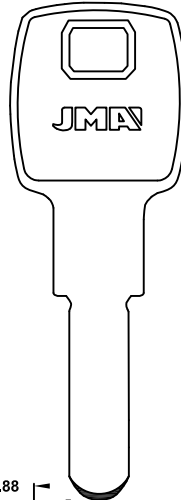

ALP.

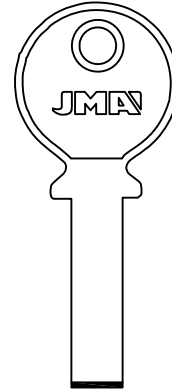

ALP.

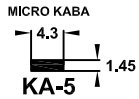

KA-5

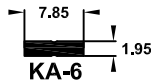

KA-6

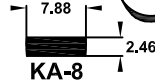

KA-8

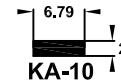

KA-10

## KABA

## KABS

## KALE

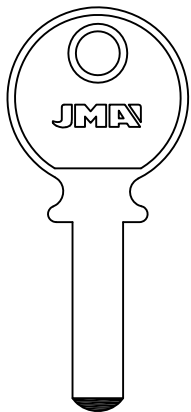

ALP.

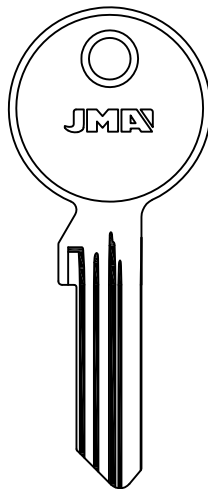

KAB-1D

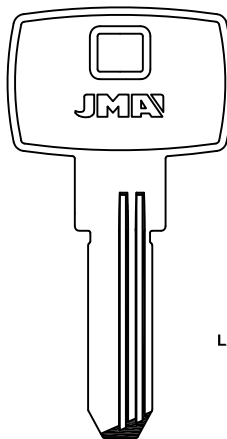

LAT.

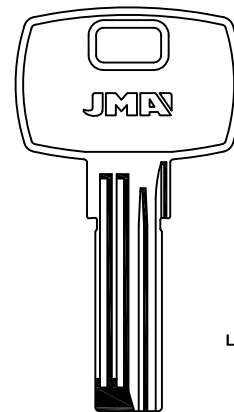

LAT.



KA-11

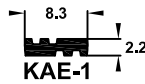

KAE-1

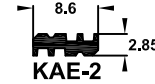

KAE-2

## KALE

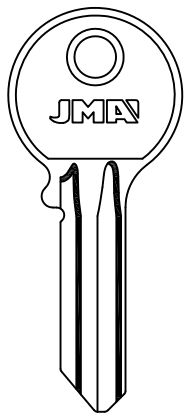

KAE-3

KAE-3D

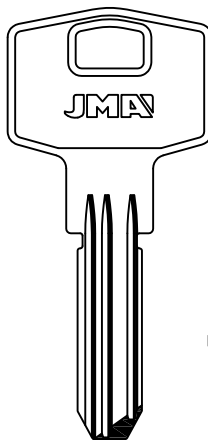

LAT.

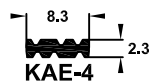

KAE-4

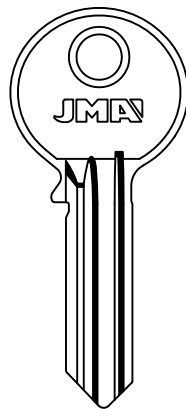

KAE-5

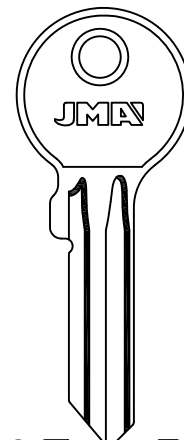

KAE-6

KAE-6D

KAE-7

KAE-7D





**PARA-FOR:**

- KALE (TR)
- KALUGA (RUS)
- KAP (RUS)
- KAZAN (RUS)

**KALE**

LAT.

LAT.

KAE-8 KAE-8D

KAE-9 KAE-9D

KAE-10D

KAE-11D

KAE-12D

KAE-13D

FAC-GAON JIS FAC

**KALE KALUGA KAP KAZAN**

LAT.

LAT.

KAE-14

KAL-1

KAL-2D

KAP-1D

KAP-2D

KAZ-1

**KAZAN**

KN

KAZ-2

KAZ-3

KAZ-4

KAZ-5

KAZ-5D



**KAZAN**

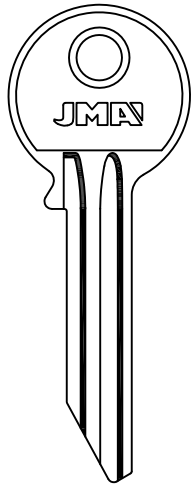

**KAZ-6**

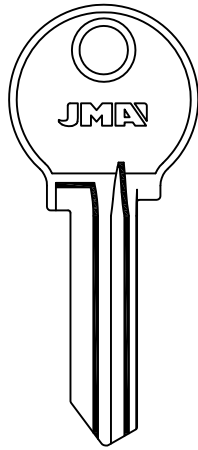

**KAZ-7**

**KESO**

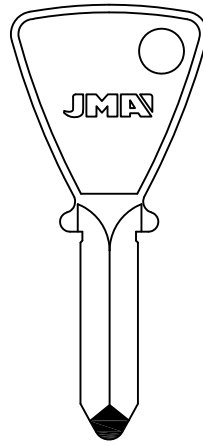

**KE-1**

JPM

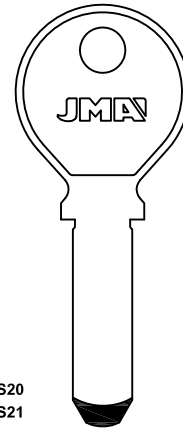

**KE-3**

S20  
S21  
S57

ALP.

**PARA-FOR:**

- KAZAN (RUS)
- KESO (CH)
- KFV (D)
- KICHINEV (RUS)
- KIFERM (F)

**KESO**

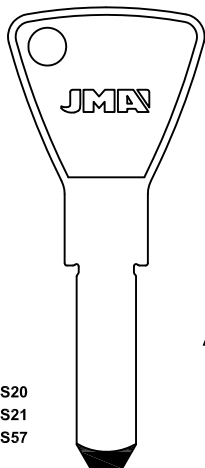

ALP.

S20  
S21  
S57

**KE-4**

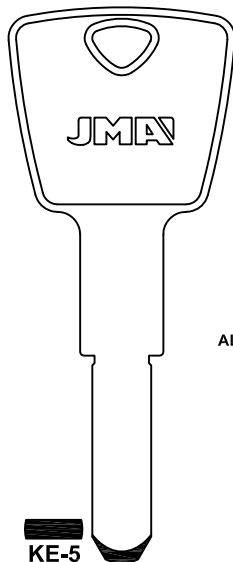

ALP.

**KE-5**

**KFV**

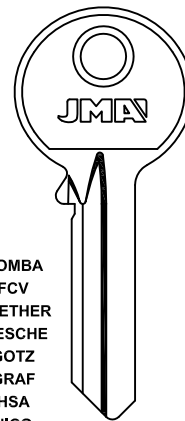

ALU.

- COMBA
- FCV
- FLIETHER
- GIESCHE
- GOTZ
- GRAF
- HSA
- NICO
- SEN
- SCHUCO

**KFV-1**

**KFV**

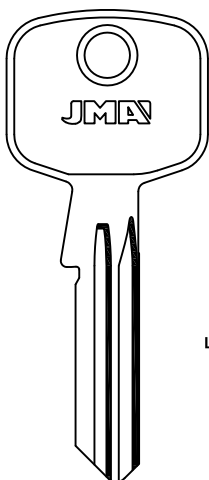

LAT.

**KFV-O**

**KFV-N**

**KFV-M**

**KFV-L**

**KFV-F**

**KFV-E**

**KFV-D**

**KFV-C**

COMBA-FCV-FLIETHER-GIESCHE  
GOTZ-GRAF-HSA-NICO-SCHUCO-SEN

**KICHINEV**

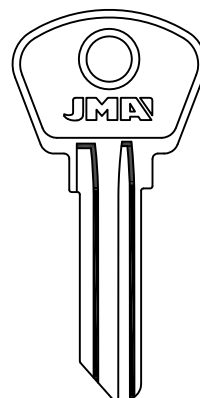

**KIC-1**

**KIFERM**

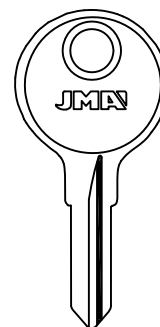

**KIF-1**











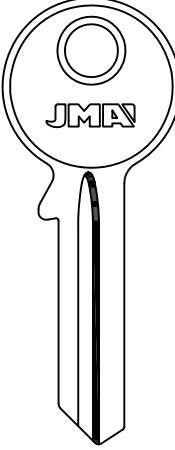
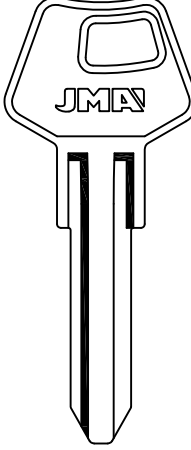

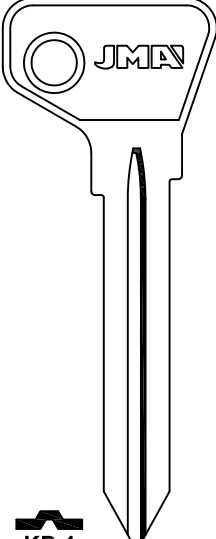

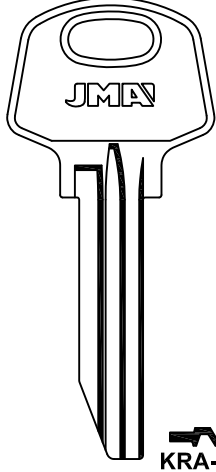

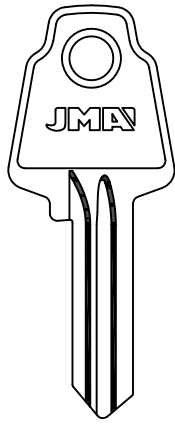

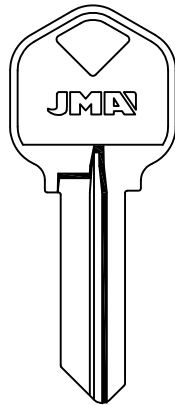

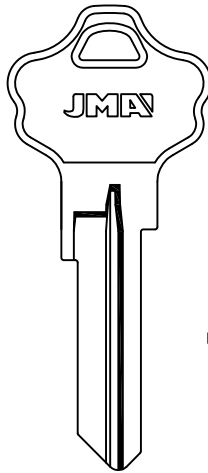

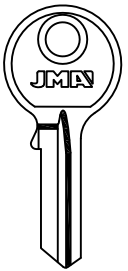
**KIF-1D**

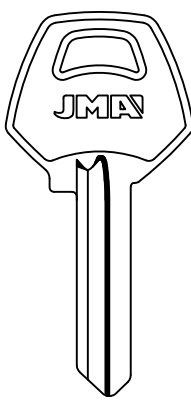
**KIF-2D**

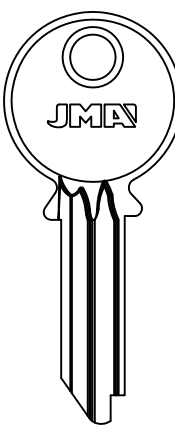

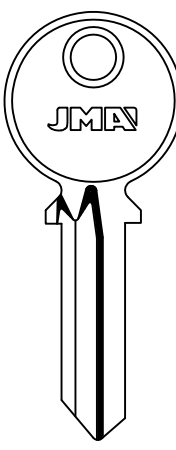
**PARA-FOR:**

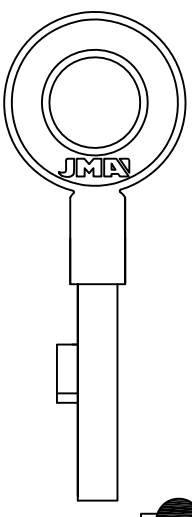
- KIROVMACH (RUS)
- KP (RUS)
- KRAMATORSK (RUS)
- KREMENCHUG (RUS)
- KWIKSET (USA)
- KYNNARPS (GB)
- LAFONTE (BR)
- LAPERCHE (F)

KIROVMACH	KP		KRAMATORSK
   KIR-1D	  KP-1		  KRA-1D  KRA-2
KREMENCHUG	KWIKSET		KYNNARPS
  KRE-1D	  KWI-1 1 AL 7 BRICARD-EZSET-VACHETTE	  KWI-2D TITAN	  KNA-1D
LAFONTE	LAPERCHE		
  LAF-1D	  LAP-1 DM	  LAP-2D	  LAP-2E LAT.



## LAPERCHE

PARA-FOR:  
LAPERCHE (F)

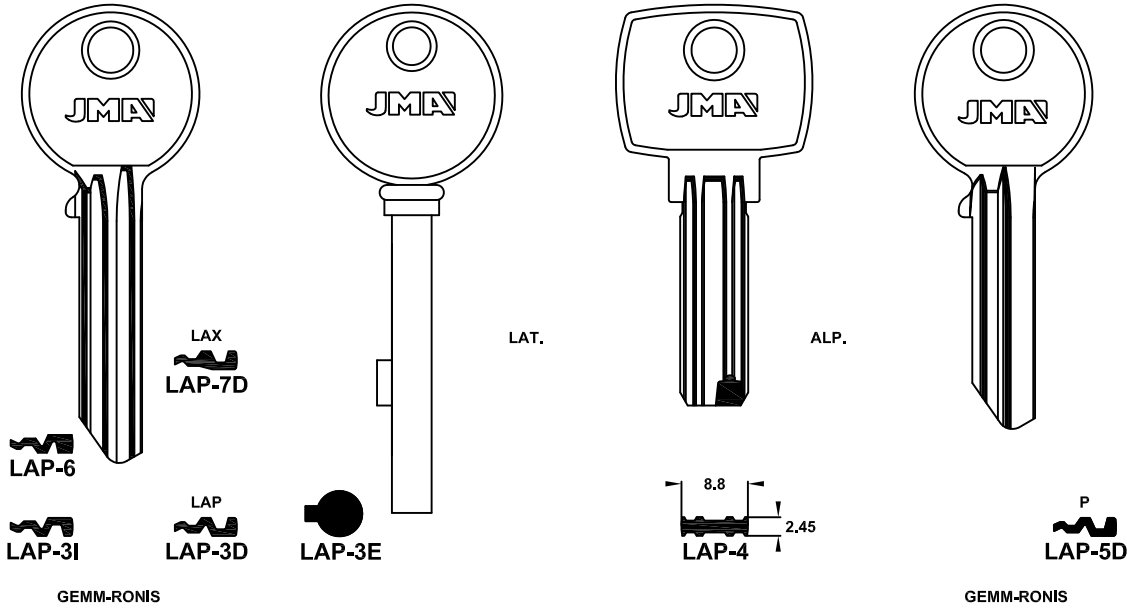

## LAPERCHE

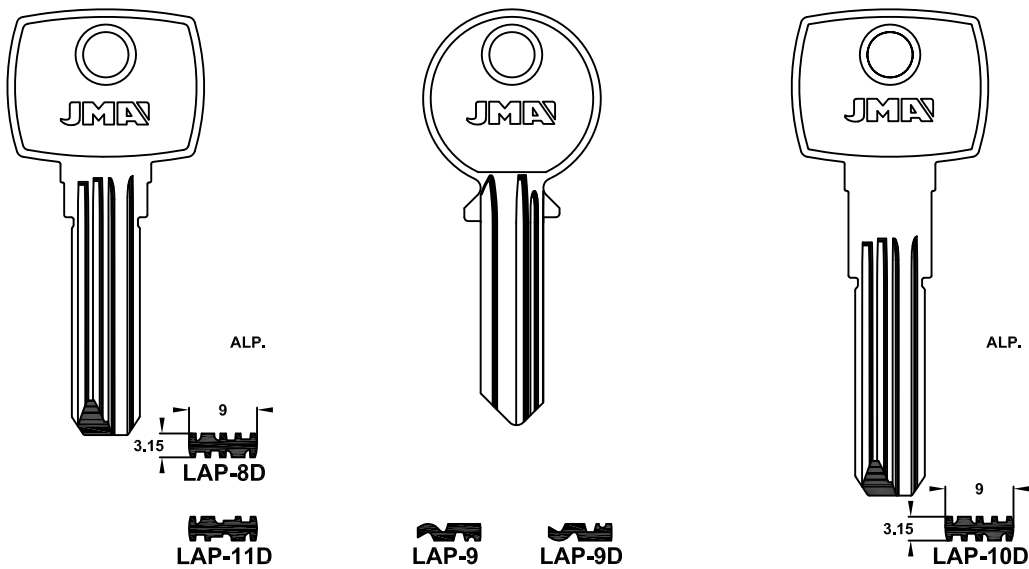

## LAPERCHE

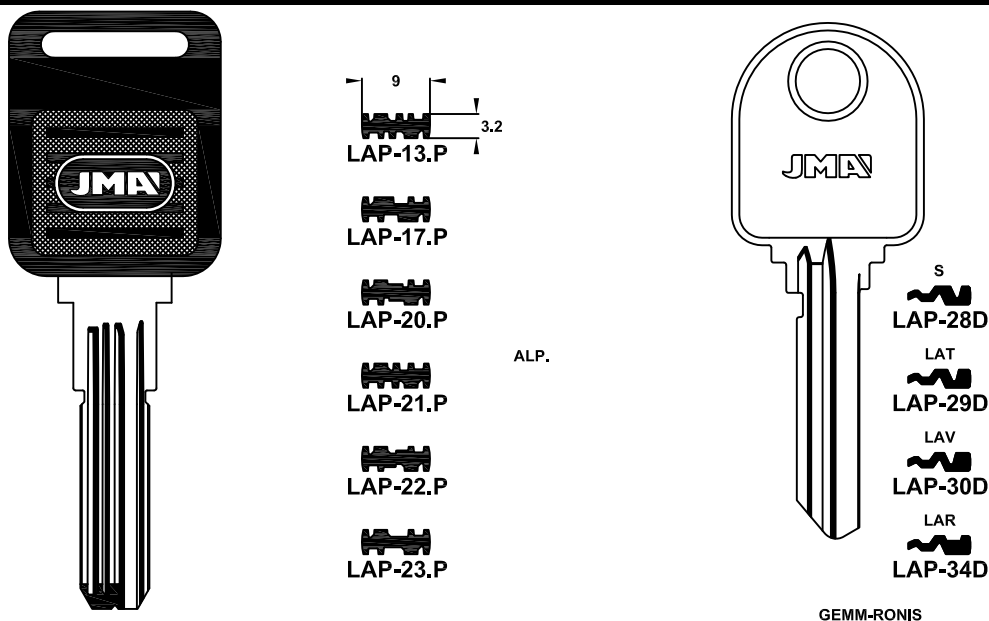

**PARA-FOR:**

LAPERCHE (F)

LAPORTE (F)

LARK (RC)

LAS (F)

**LAPERCHE**

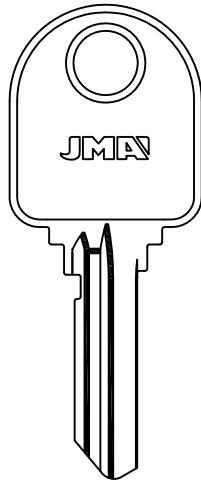

S  
LAP-42D

X  
LAP-43D

T  
LAP-44D

V  
LAP-45D

R  
LAP-46D

GEMM-RONIS

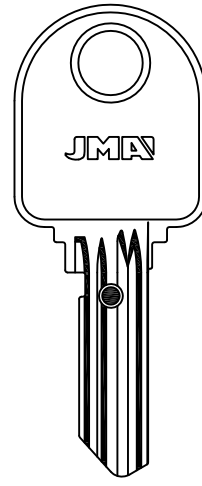

BDC  
LAP-88

FICHET

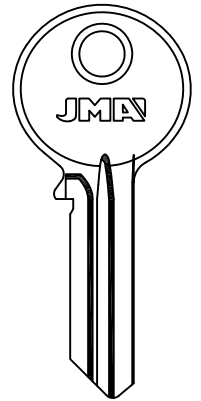

LAP-96D

VACHETTE

**LAPORTE**

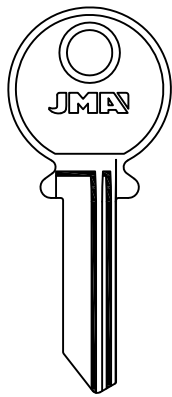

LPO-1

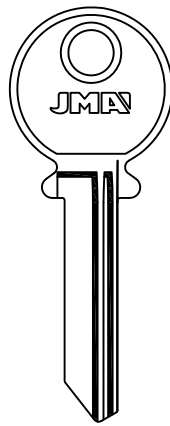

LPO-2

**LARK**

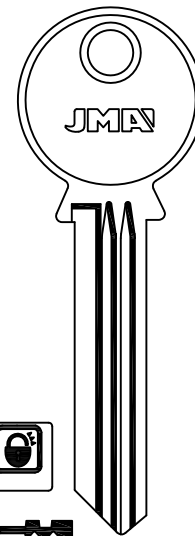

LAR-11

**LAS**

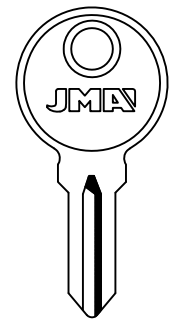

AX  
001-224  
LAS-AX

EX  
LAS-1D

ATAL-HÄFELE-KIFERM-RENZ

**LAS**

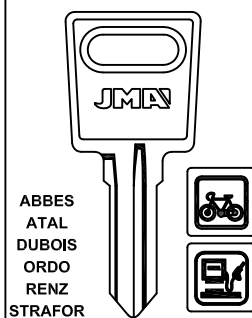

FM  
LAS-2

FM  
001-400  
501-550  
LAS-4



FH  
001-400  
501-550  
LAS-FH

LAS-4D

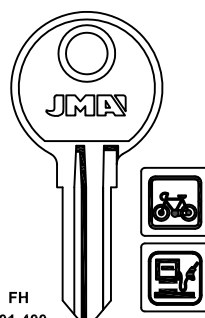

FH  
001-400  
501-550  
LAS-3

H  
LAS-5

U  
LAS-U

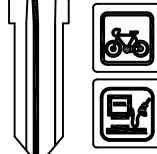

KIFERM

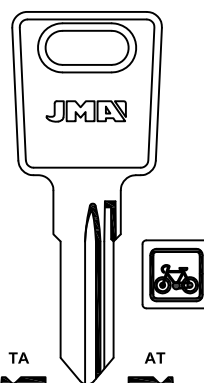

TA  
LAS-6

RM  
0001-2000  
KT  
3001-4000  
LAS-KT

LAS-6D



AT  
LAS-6D

TK  
4001-5000  
LAS-TK

LAS-7

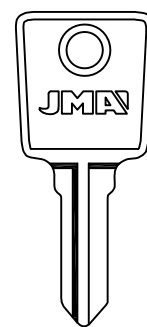

ABBES-ORDO

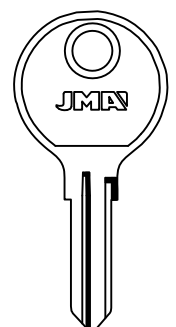

LS  
LAS-8

L  
LAS-9



# LAS

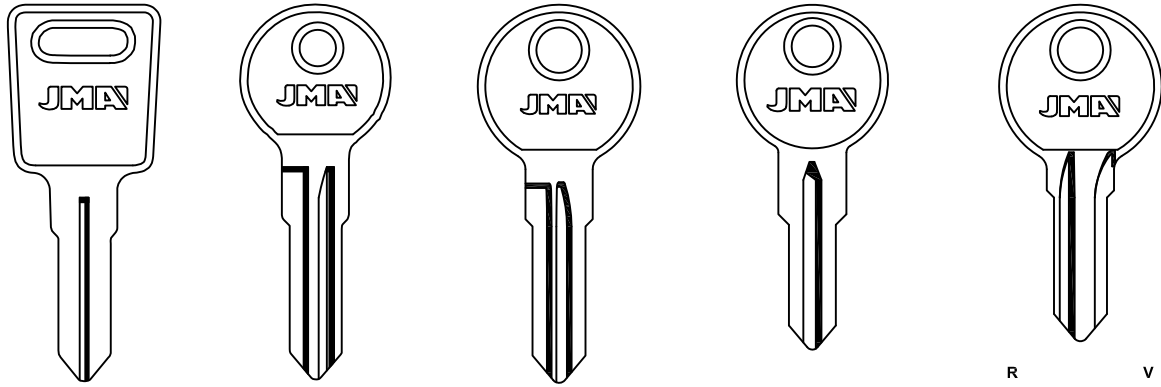

PR  
LAS-10

LAS-11

A...1-650  
LAS-11D

LAS-12D

AX  
001-224  
LAS-AX/L

R  
001-224  
LAS-R

V  
001-224  
LAS-V



Y  
001-224  
LAS-Y

MARCADET

ATAL-KIFERM-RENZ

ATAL-HÄFELE-KIFERM-RENZ

DUBOIS-KIFERM-PJ-PK

# PARA-FOR:

LAS (F)

LÅSBOLAGET (S)

LEGALLAIS (F)

LEGE (GB)

LINCE (E)

## LAS

## LÅSBOLAGET

## LEGALLAIS

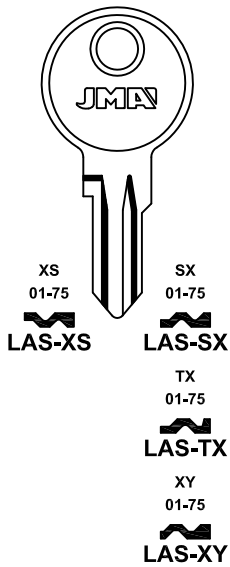

ATAL-JU-KIFERM-METEOR-RENZ

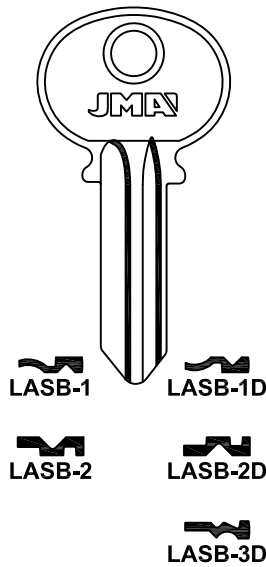

TANLOCKS

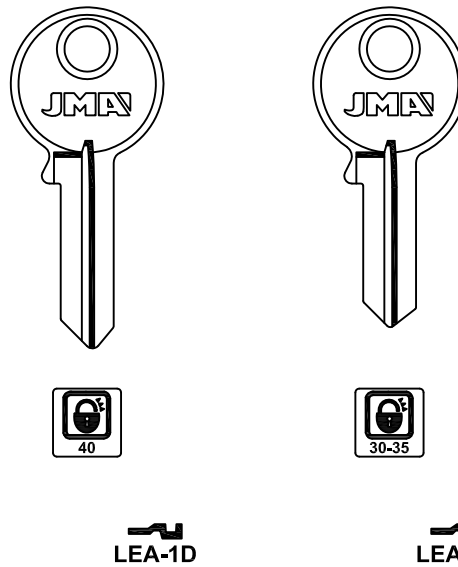

## LEGE

## LINCE

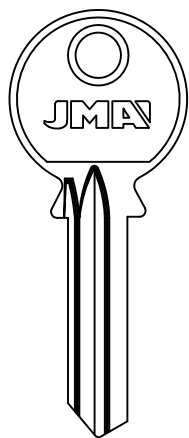

1 AL 7  
LEG-1D

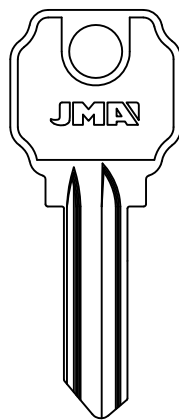

A  
LIN-11  
A  
LIN-1D

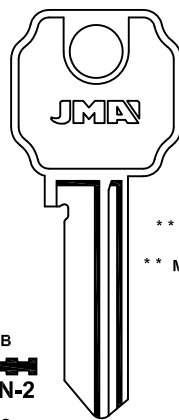

B  
LIN-2  
C  
LIN-31  
R  
LIN-151  
NO COL.  
LIN-15D

\*\* FSH.  
\*\* MTIC.(L)  
\* LAT.  
\* ALU.

LIN-4  
LIN-14  
N  
LIN-41  
N  
LIN-4D  
LIN-141  
LIN-14D  
U (A)  
LIN-20D



**PARA-FOR:**

LINCE (E)

LIPS (NL)

**LINCE**

\* LAT.

D  
LIN-5I      D  
LIN-5D

T  
LIN-12I      T  
LIN-12D

D1  
LIN-18      D1  
LIN-18D

E  
LIN-6I      E  
LIN-6D

F  
LIN-7I      F  
LIN-7D

J  
LIN-8I      J  
LIN-8D

30-40      20-25      25

**LINCE**

ALP.

K  
LIN-9

M  
LIN-10I      M  
LIN-10D

S  
LIN-16      S  
LIN-16D

O  
LIN-11I      O  
LIN-11D

60-70      60-70      15

9      2.45  
LIN-13

**LINCE**

**LIPS**

LAT.

LAT.  
WNC.

9      2.45  
LIN-19D

9      2.45  
LIN-21D

R  
LIN-25      R  
LIN-25D

30      35  
LIP-11      LIP-1D

CRAIN-ICSA-SIB





LIPS

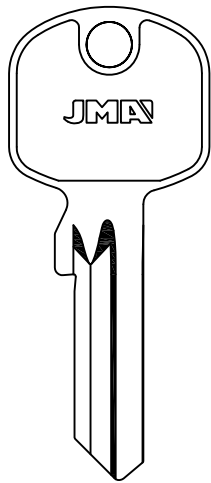

35  
LIP-1GD

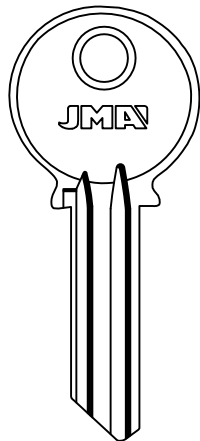

34  
LIP-2

29  
LIP-2D

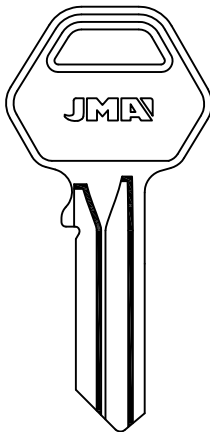

26  
LIP-3

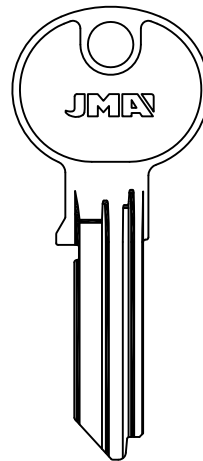

E03  
LIP-4

PARA-FOR:

LIPS (NL)

LITTO (B)

LOB (PL)

LIPS

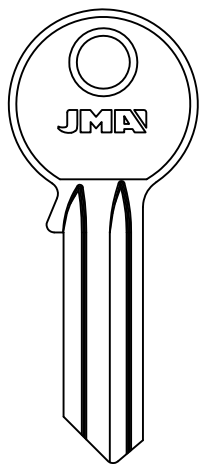

33  
LIP-33

28  
LIP-28D

LITTO

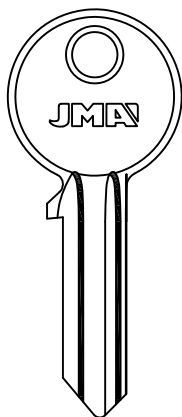

E  
LIT-11

ANKERSLOT

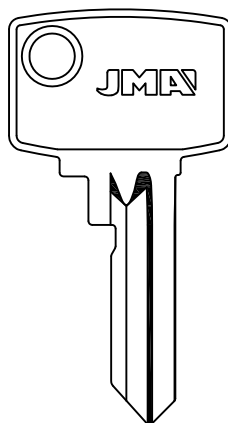

LIT-2D

ALU.  
MTIC.

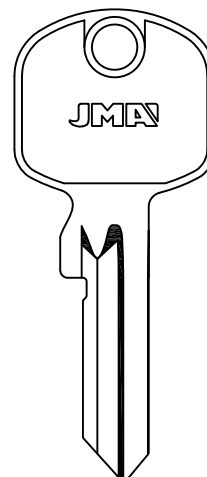

LIT-2GD

LITTO

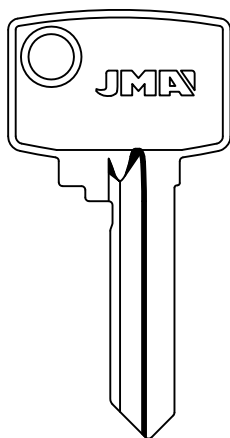

LIT-3D

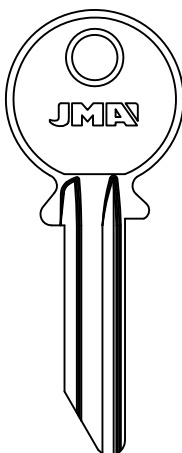

LIT-5I

LIT-5D

BKS

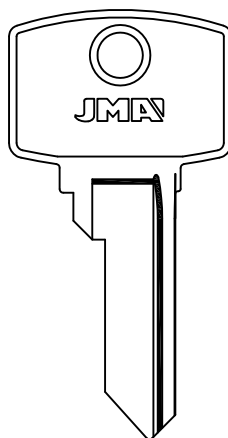

LIT-7D

LOB

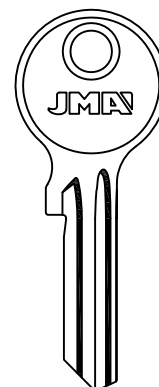

LB-1







LB-1D



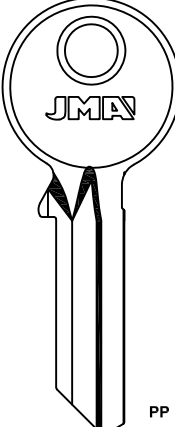
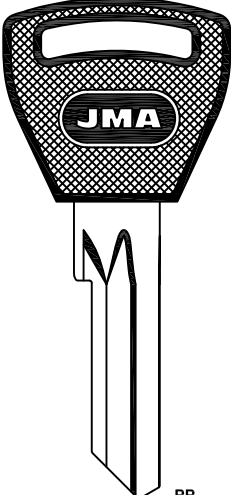
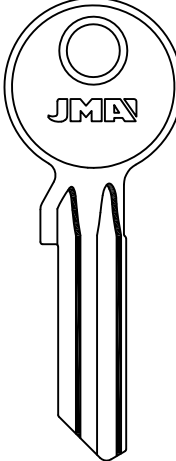
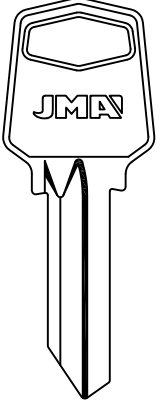





EXPRES

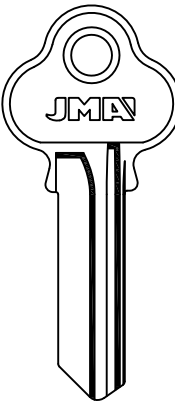
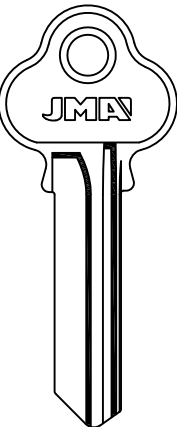
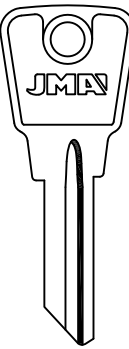
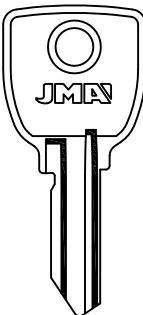
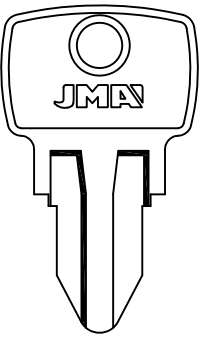









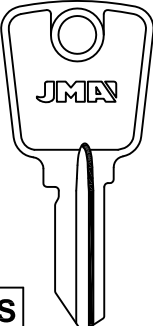
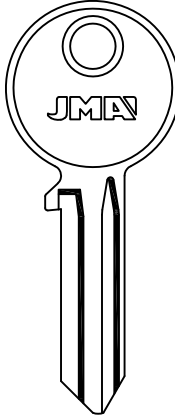
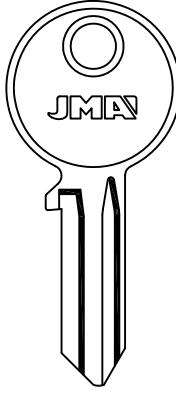
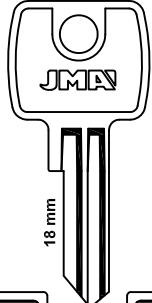



**PARA-FOR:**

- LOB (PL)
- LOCK (MEX)
- LOCKWOOD (USA)
- LOGO (I)
- L.&F. (GB)

LOB			LOCK	
				
 PP LB-2D   LB-4D	 PP LB-2D.P	 LB-3  LB-3D	 LOC-1D ACE. LAT.	
BRICARD-EXPRES-REDY-YETI		BRICARD-EXPRES-REDY-YETI		

LOCKWOOD				
				
 0 AL 9 A LWO-1  LWO-1D	 0 AL 9 A LWO-2  LWO-2D	 24A LWO-7D	 CL.. 1-1000 LWO-8	 N LWO-9
GAINSBOROUGH				LEN-LOK

LOCKWOOD	LOGO		L. & F.
			
AUS	ALU.		18 mm
 ...151-250 L...1-960 ...1-960 LWO-26D	 LO-1I  LO-1D  LO-3D  50-60	 LO-2I  LO-2D  30-40  LO-4D	 LF-1I  LF-1D 90...1-200 ...1-400 91...201-275 GH...1-4000 SS...1-400 91...276-350 CEM-EURO LOCKS-UNION
LEN-LOK	CISA	CISA	



## LOWE & FLETCHER

PARA-FOR:

L.&F. (GB)

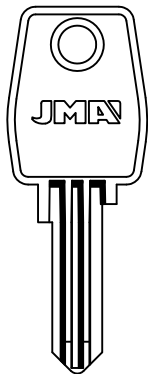

95001-97000  
97001-99000



LF-2

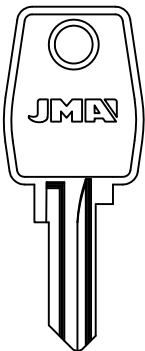

LF-4I

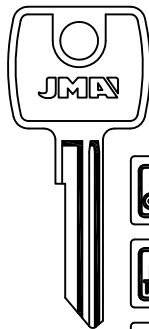

....  
70001-71000  
M....  
70001-71000



LF-5



LF-5D

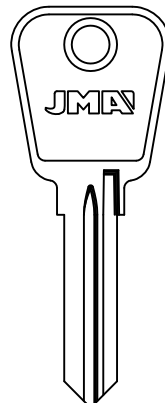

....  
66001-67200



LF-7

.....  
81001-87000



LF-7D

LF-12 LF-12D  
BICICLETTES CYCLES  
DOBLE SAFE-EURO LOCKS

EURO LOCKS

TELFORD

FORD EUROPA

## LOWE & FLETCHER

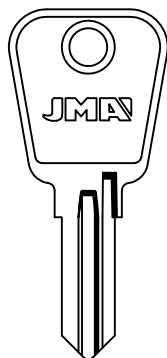

93...201-400  
.....93901-94000



LF-8



LF-8D

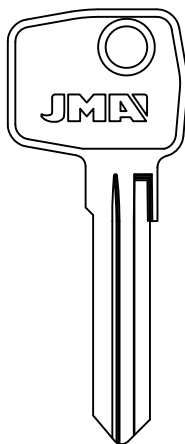

LF-10

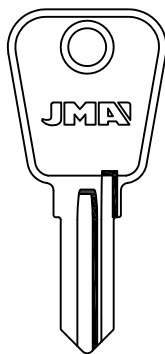

93...201-400  
.....93901-94000



LF-13



LF-13D

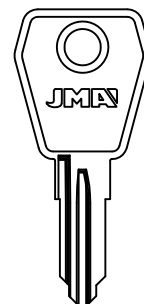

LF-14D

EURO LOCKS-MIBRA-UTZ

EURO LOCKS

MIBRA-UTZ

EURO LOCKS

## LOWE & FLETCHER

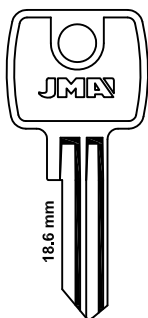

18.6 mm



60... 001-200  
60... 001-200  
90... 001-200  
...1-400  
GHM...1-155  
M...1-400  
RV...1-400  
RVM...1-400  
SP...1-400  
99...1-400



LF-15

FFE  
001-100



LF-17

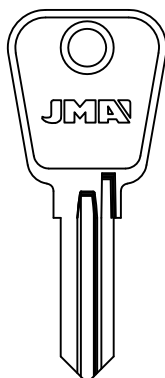

LF-16

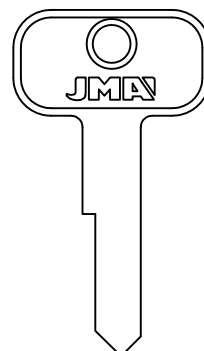

LF-18D

CEM-EURO LOCKS-ULTRA-UNION

**JMA**<sup>®</sup>

Copyright by Alejandro Altuna S.A. 2014



ATENCIÓN: Concerniente a las marcas y denominaciones comerciales ver nota en índice.  
ATTENTION: Concerning the marks and commercial denominations see note in index.  
ATTENTION: Concernant les marques et dénominations commerciales voir la note dans l'index.  
ACHTUNG: Beziehen auf die marke und handelsname sehen sie die notiz im index.

**PARA-FOR:**

L.&F. (GB)

**LOWE & FLETCHER**

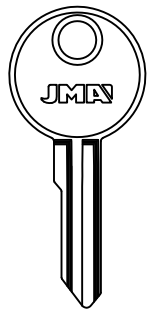

**LF-19**

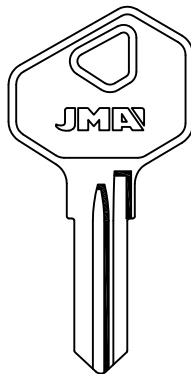

**LF-20**

19...1-420  
....17001-19000  
....7001-9000

**LF-20D**

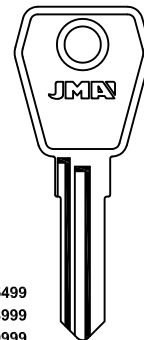

....35000-35499  
....78000-78999  
....79000-79999

**LF-21**

**LF-33D**

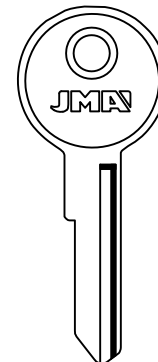

**LF-22**

**LOWE & FLETCHER**

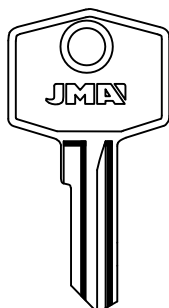

**LF-23**

ULTRA

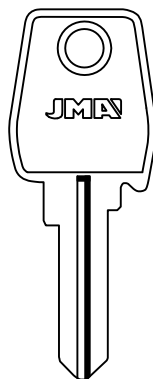

**LF-24**

DOBLE SAFE-EURO LOCKS

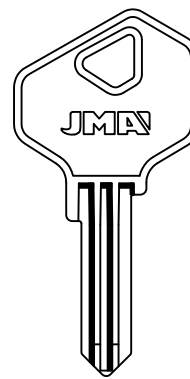

V..1-88  
**LF-25**

14001-14088

**LF-40**

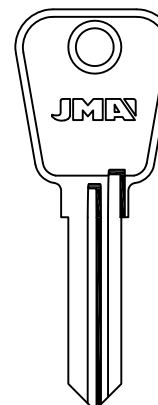

**LF-26**

**LOWE & FLETCHER**

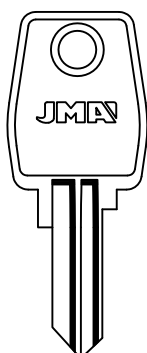

**LF-27**

EURO LOCKS

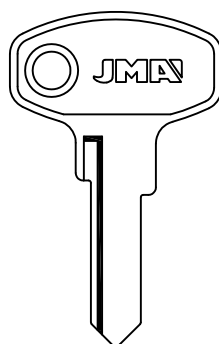

**LF-28**

EURO LOCKS

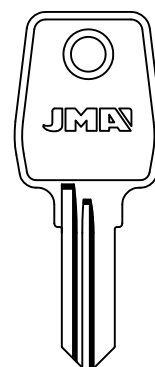

93...401-900  
....90901-90975

**LF-29D**

EURO LOCKS

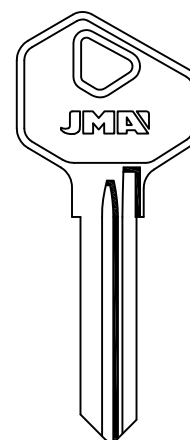

09...1-900  
29...1-478

**LF-30**



## LOWE & FLETCHER

## PARA-FOR:

L.&F. (GB)  
 LT (PRC)  
 LUCKY (RC)  
 LUMA (E)

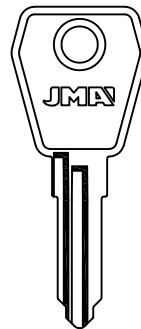
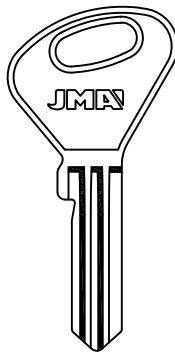
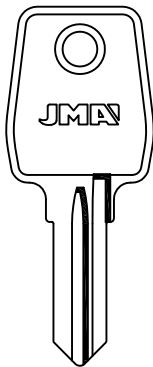
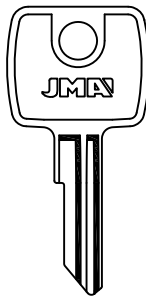
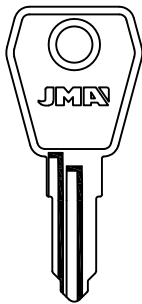

LF-31

LF-34

R...201-600  
 ...9001-9494

LF-35

LF-36

LF-37D

LF-38D

## LOWE & FLETCHER

## LT

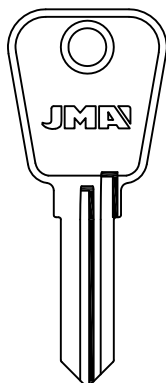

LF-41

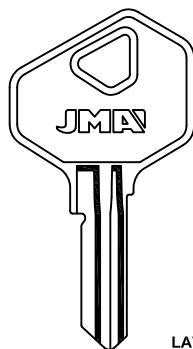

LAT.

92...601-800

LF-44

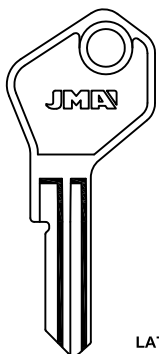

LAT.

92...1-400  
 60...001-400  
 ...1-400  
 ...RV1  
 ...ES1  
 91...201-350  
 M...1-400

LF-45

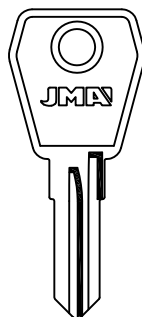

LF-46

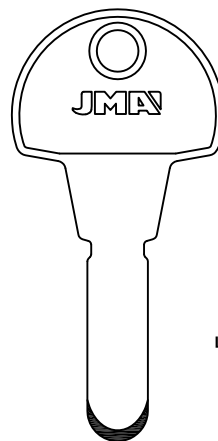

LAT.



LT-1

## LUCKY

## LUMA

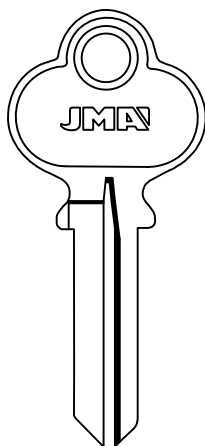

LUC-1D

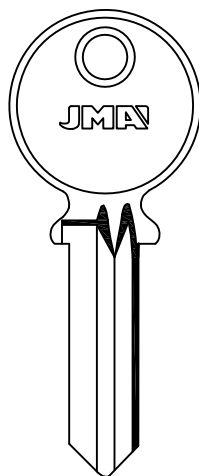

LUC-2

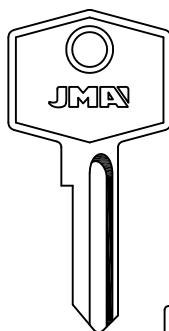

A1101-A1112

LUMA-1I

B3301-B3312

LUMA-2I

A2201-A2212

LUMA-1D

B4401-B4412

LUMA-2D

C5501-A5512

LUMA-3I

LUMA-4I

C6601-C6612

LUMA-3D

LUMA-4D

BASTA

**JMA**<sup>®</sup>





Copyright by Alejandro Altuna S.A. 2014





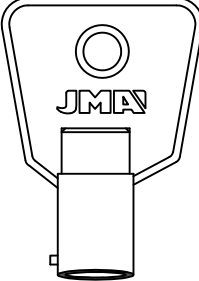
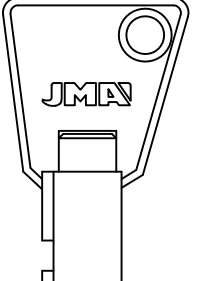
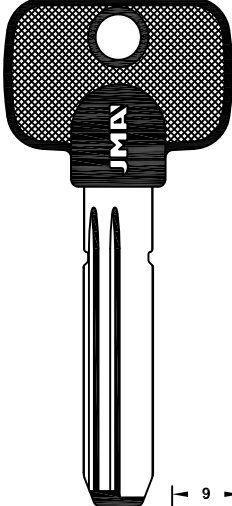
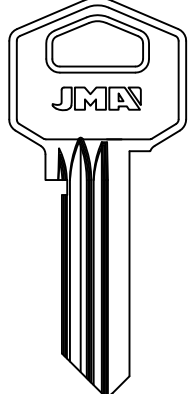

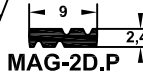

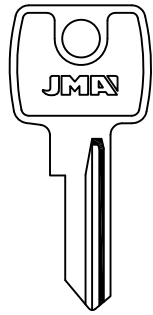
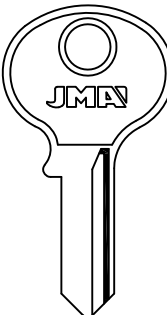
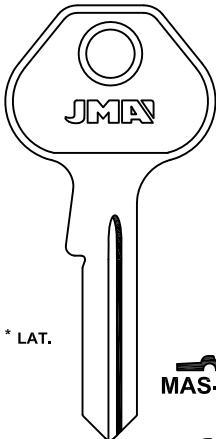
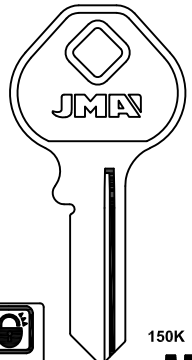

ATENCIÓN: Concerniente a las marcas y denominaciones comerciales ver nota en índice.  
 ATTENTION: Concerning the marks and commercial denominations see note in index.  
 ATTENTION: Concernant les marques et denominations commerciales voir la note dans l'index.  
 ACHTUNG: Beziehen auf die marke und handelsname sehen sie die notiz im index.

**PARA-FOR:**

- LYF (E)
- MAGNUM (GB)
- MARIANI (I)
- MARQUES (P)
- MASTER (USA)

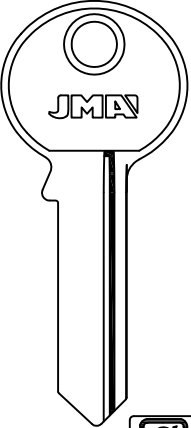
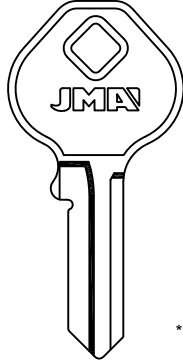
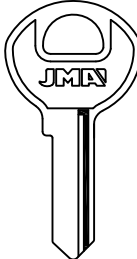
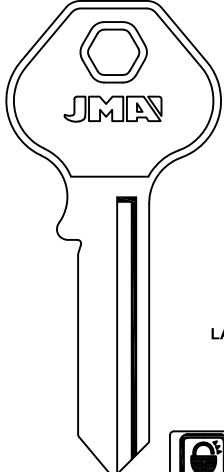
LYF		MAGNUM	MARIANI
			
LAT.	LAT.	ALP.	
			
LYF-1T	LYF-2T	MAG-2D.P	MA-5D

MARQUES	MASTER		
			
			
MQ-11 MQ-1D	MAS-1 MAS-1D	* LAT. MAS-2D MAS-22D MAS-24D 7000 *	150K MAS-3D MAS-11 MAS-11D MAS-12D

MASTER			
			
			
MAS-4D	* MAS-5D MAS-6	MAS-7 MAS-7D	MAS-8



**MASTER**

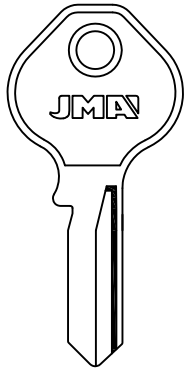

LAT.

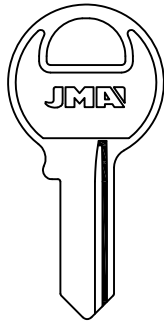

LAT.

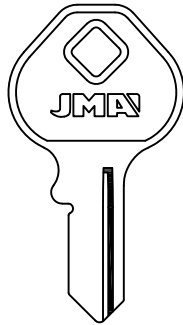

LAT.



LAT.



MAS-9

MAS-9D



MAS-10

MAS-10D



MAS-13D



MAS-15.P

**PARA-FOR:**  
 MASTER (USA)  
 MASTER LOCK (TJ)  
 MAXUS (UA)  
 MCL (RUS)  
 MCM (E)

**MASTER**

**MASTER LOCK**

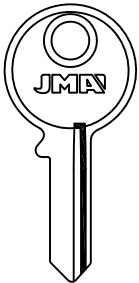

LAT.

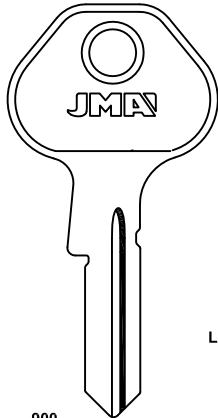

LAT.

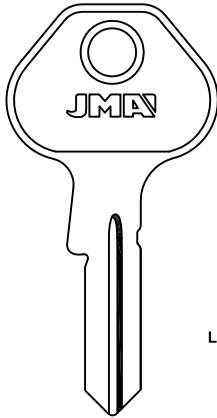

LAT.

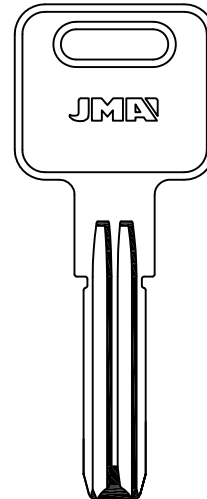

LAT.

MAS-17

MAS-17D

900  
MAS-19

6000  
MAS-18D

6000B  
MAS-29D

MASL-1

**MAXUS**

**MCL**

**MCM**

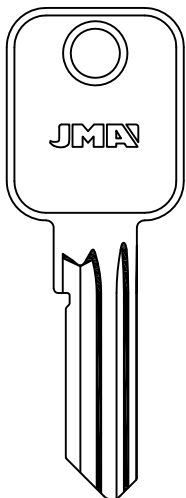

MXS-1

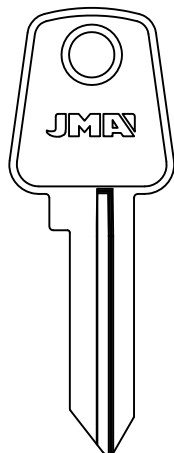

MCL-1D

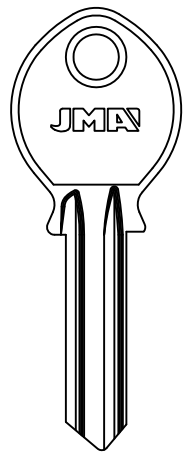

MCM-1

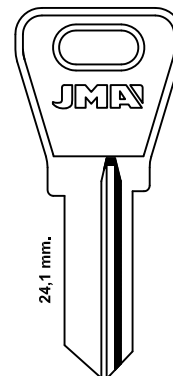

MCM-21 MCM-2D

24,1 mm.





PARA-FOR:

MCM (E)

MCM

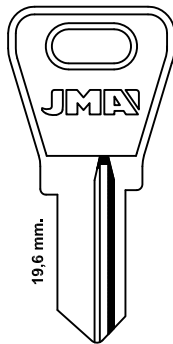

MCM-3I

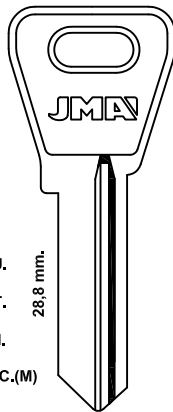

\* ALU.  
\* LAT.  
\* FSH.  
\*\* MTIC.(M)

\* MCM-4I

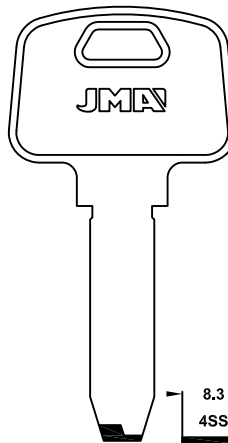

MCM-4D \*\*

MCM-4EC

ESAFE-K+K

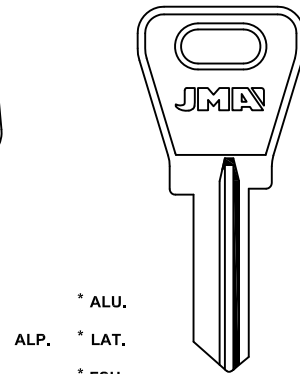

MCM-4SS

MCM-11S

LOB-YETI

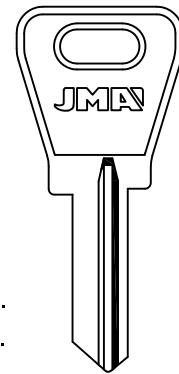

\* ALU.  
\* LAT.  
\* FSH.

MCM-5I

COFER

\* MCM-5D

MCM

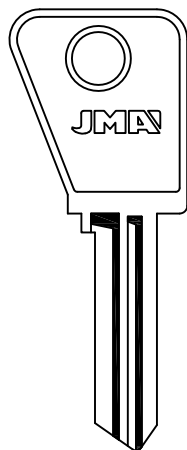

MCM-6

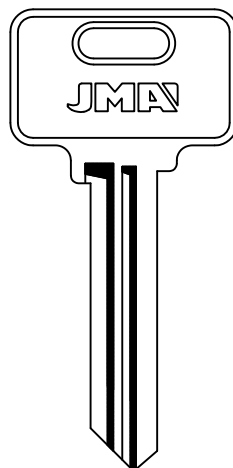

MCM-7

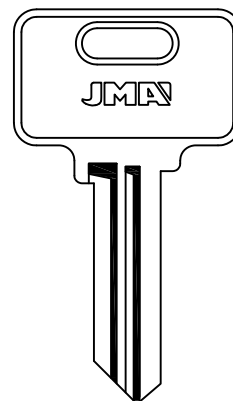

MCM-8

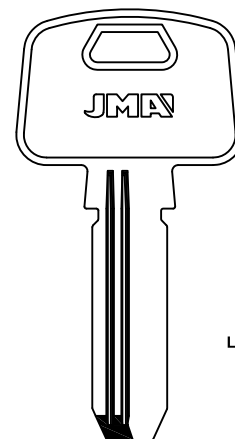

MCM-10

ESAFE-TROMER

LAT.

MCM

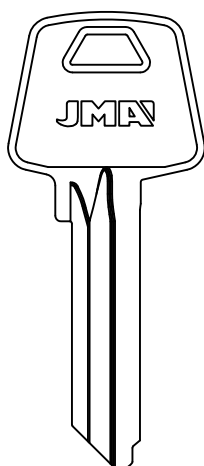

MCM-12D

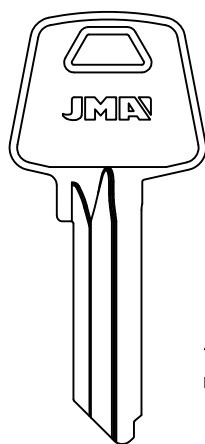

MCM-13D

ALU.  
FSH.

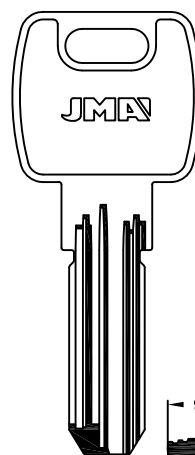

MCM-16

MCM-21D

DIERRE

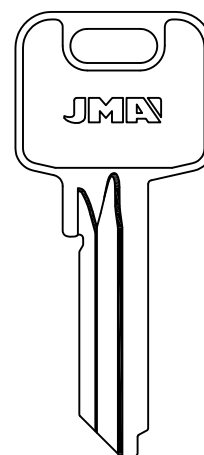

X.....1234567890  
E.....11241-79868  
E-1

MCM-18D



**MCM**

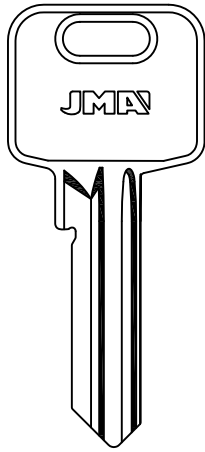

B  
MCM-24B

C  
MCM-24C

D  
MCM-24D

E  
MCM-24E

F  
MCM-24F

MCM-26

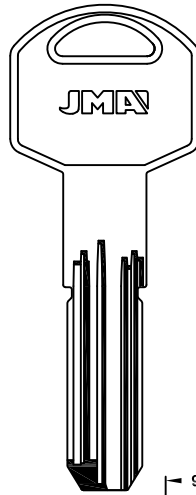

LAT.

9.7  
E8  
2.8  
MCM-27

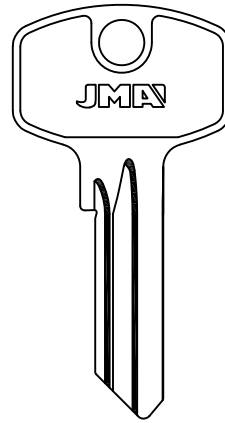

MCM-29D

**PARA-FOR:**

- MCM (E)
- ME-FA (RC)
- MECO (D)
- MELSMETALL (D)

**MCM**

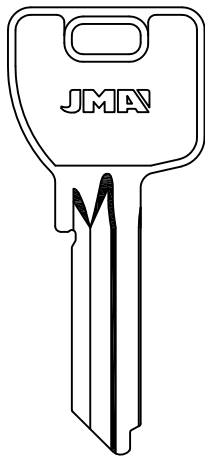

E  
MCM-30D

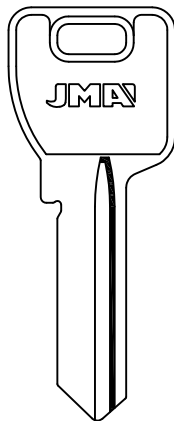

25  
MCM-31

C  
MCM-31D

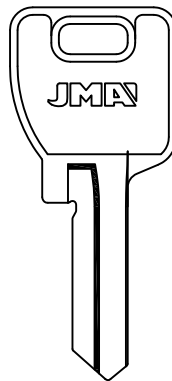

OV  
MCM-32D

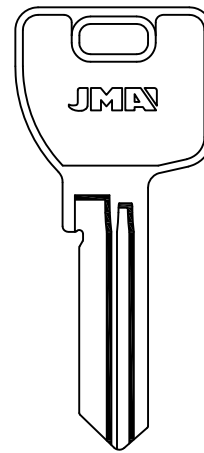

AV  
MCM-33

**MCM**

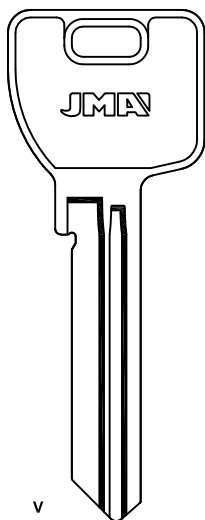

V  
MCM-35

**ME-FA**

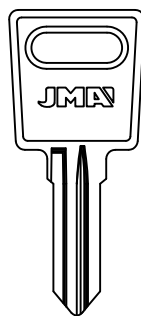

...1-100  
BRA-1  
BRABANTIA-CLAUSOR-CASH BOX  
ELSET

**MECO**

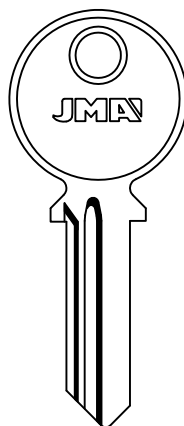

MEC-5D

**MELSMETALL**

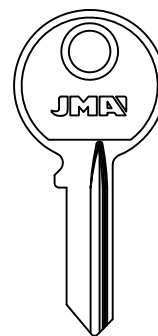

MEL-1

MEL-4

MEL-4D



**PARA-FOR:**  
 MELSMETALL (D)  
 MERONI (I)

**MELSMETALL**

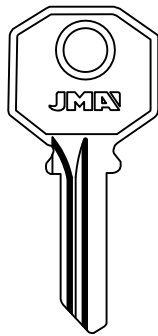

MEL-2D

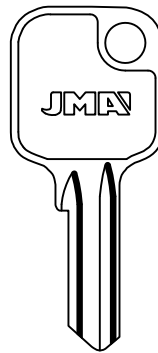

MEL-3

HBC



MEL-5.P

SECURIKEY

**MERONI**

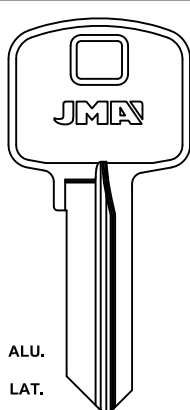

ALU.  
LAT.

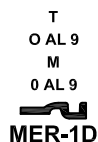

MER-1D

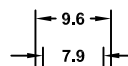
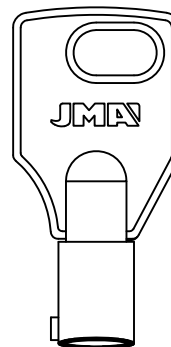
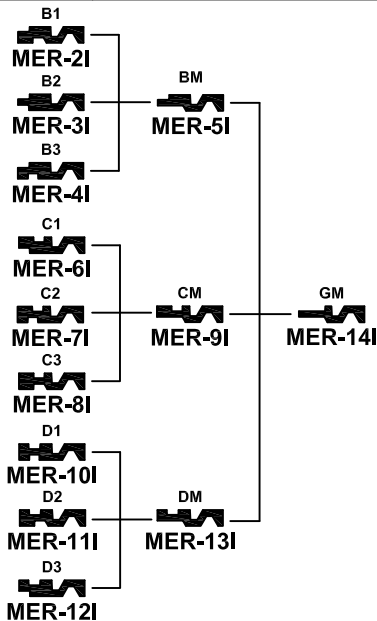

MER-1T

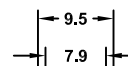
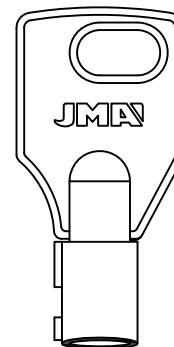

MER-3T

**MERONI**

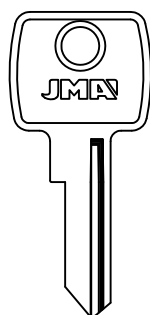

MER-15

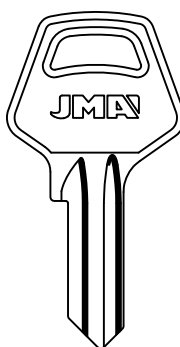

MER-16

LAMA

MER-16D

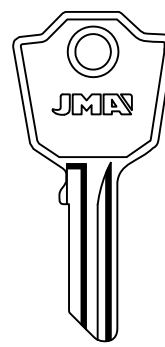

MER-17

LAMA

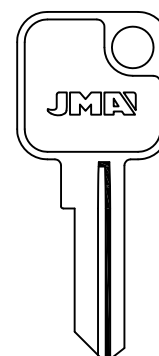

MER-18

PREMI-APRI

G...3001-3480  
 G...0-480  
 ...3001-3480

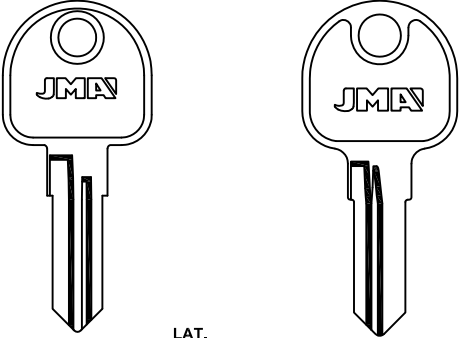
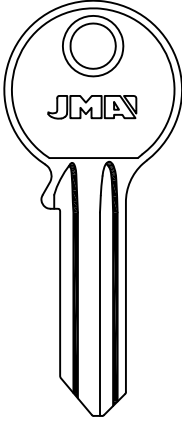
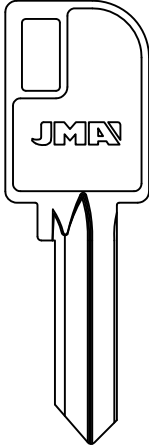
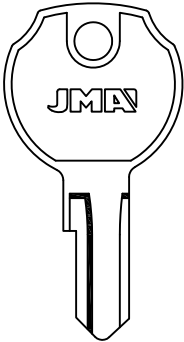
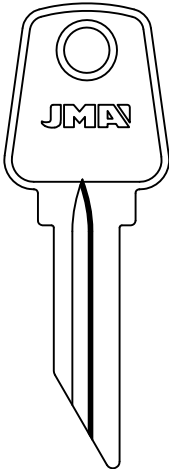
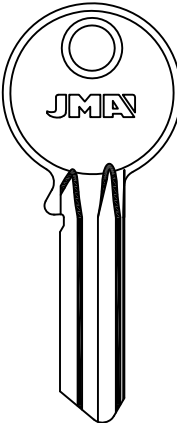
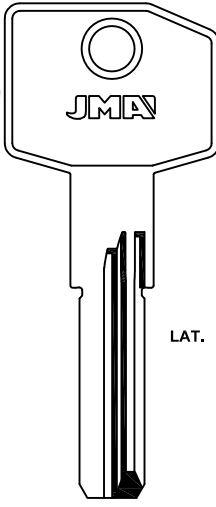
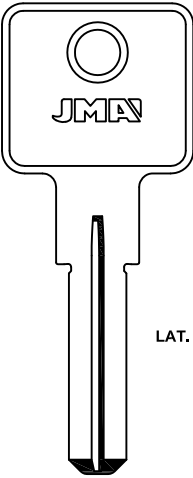
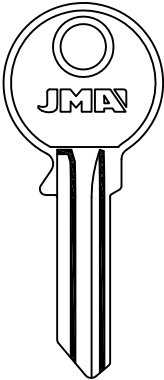
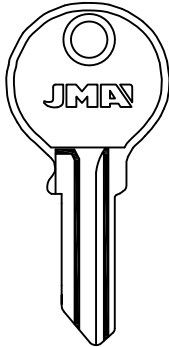
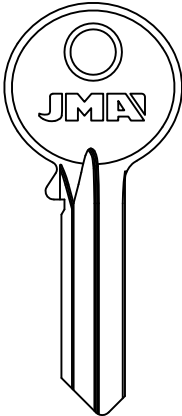
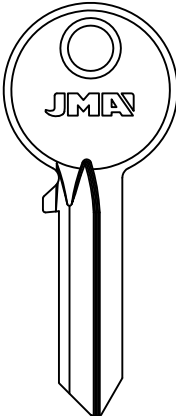

MERONI		METAL	METALUX	
 <p>LAT.</p> <p>CC MER-20D</p> <p>CD MER-21D</p> <p>MER-19D</p>		 <p>MTL-1    MTL-1D</p>	 <p>MET-2D</p> <p>CAS-CISMA</p>	
METEOR	METIZ	MG (MONTI)		
 <p>B...1-600 G...1-600</p> <p>MTO-1</p>	 <p>MEZ-1D</p>	 <p>MGA-1    MGA-1D</p>	 <p>LAT.</p> <p>MGA-2</p> <p>TROMER</p>	 <p>LAT.</p> <p>MGA-3</p>
MICHEL-SEAT		MILA		
	 <p>LAT.</p>			
<p>MCH-1    MCH-1D    MCH-2    MCH-2D</p> <p>OMR-POTENT                    AM-POTENT</p>		<p>MI-1D</p>	<p>MI-2D</p>	











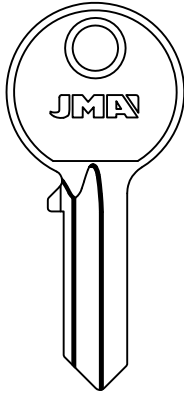
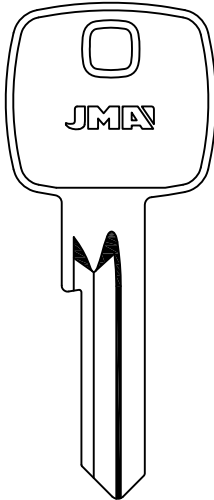
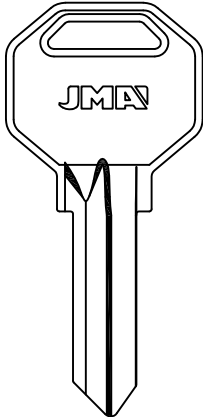
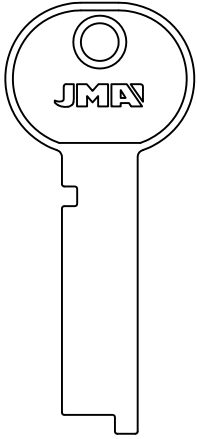

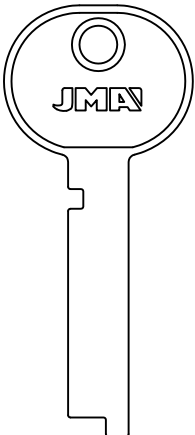
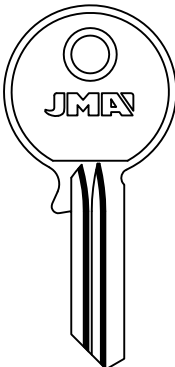
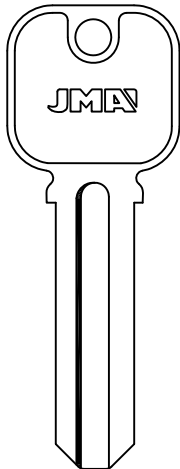
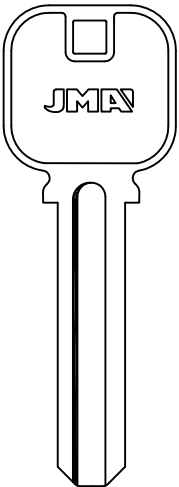

**PARA-FOR:**

- MERONI (I)
- METAL (BG)
- METALUX (F)
- METEOR (D)
- METIZ (RUS)
- MG MONTI (I)
- MICHEL-SEAT (I)
- MILA (DK)

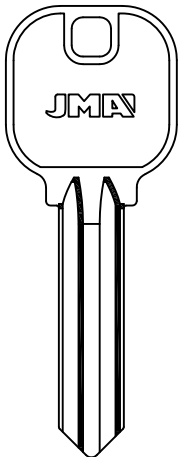
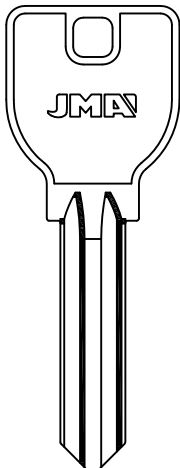
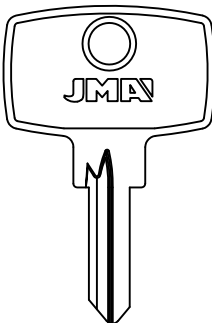
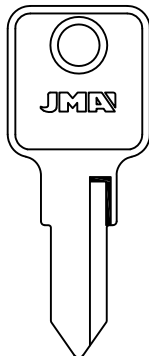

**PARA-FOR:**

- MILA (DK)
- MILES (RUS)
- MING-TAY (RC)
- MIWA (J)
- MLM (F)

MILA		MILES	
			
 MI-3D	 MI-4D	 MI-5D TRINITY	 MIL-1
MILES	MING-TAY	MIWA	
			
 MIL-2	 MIN-1D	 MIW-1	 MIW-2
MIWA		MLM	
			
1-2-3-4 1-2-3-4-5  MIW-3	1-2-3-4 1-2-3-4-5  MIW-4	 MLM-1D DOM-STUV	 MLM-2  MLM-5  MLM-5D DOM-STUV

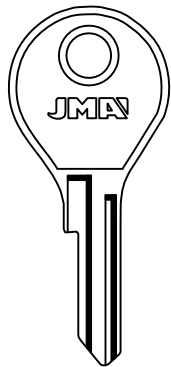

**MLM****MLM-3**

DOM-STUV

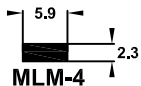
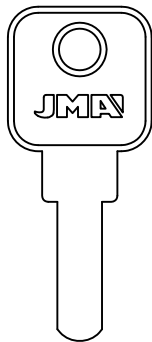
**MLM-4**

LAT.

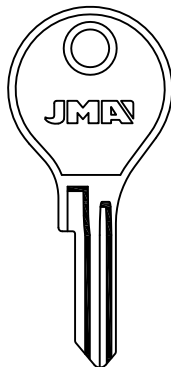
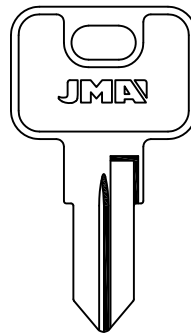
**MLM-6****MLM-7****MOBELLA****MBL-1****MBL-1D****PARA-FOR:**

MLM (F)

MOBELLA (S)

MOGILEV (RUS)

MON (E)

MONOBLOC (F)

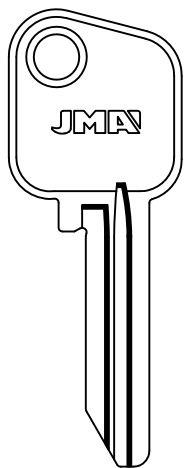
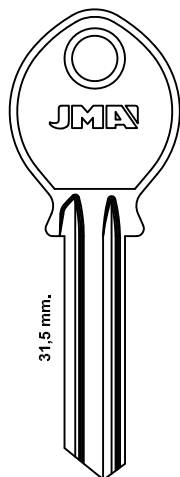
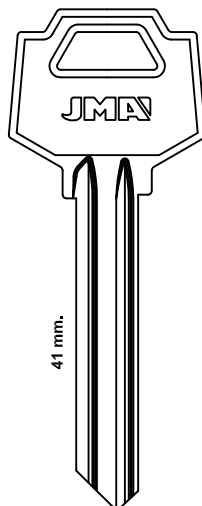
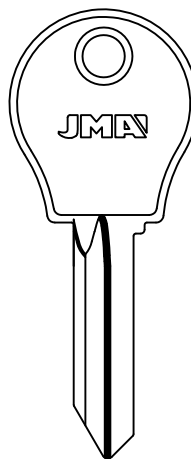
MOSRENTGUEN  
(RUS)**MOGILEV****MOG-1D****MON****MON-1I****MON-1D****MON-2I****MON-2D****MONOBLOC****MNO-1D**

FO

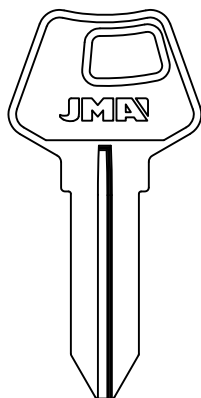
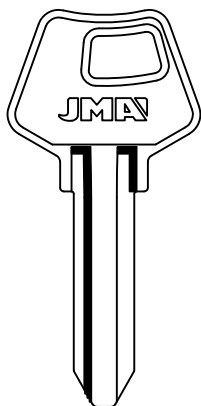
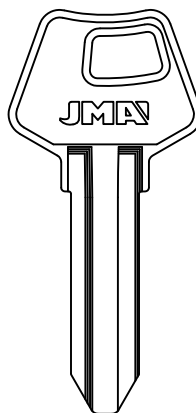
**MOSRENTGUEN****MR-1****MR-2****MR-3**

**PARA-FOR:**

- MOTTURA (I)
- M.P. PLODARI (I)
- MSM
- MSV (P)
- MUL.T.LOCK (IL)

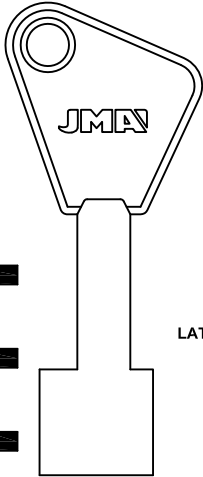
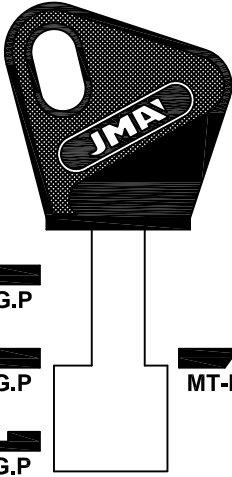
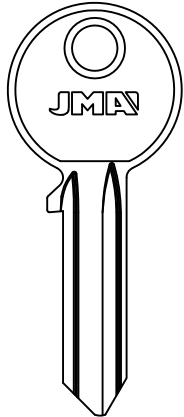
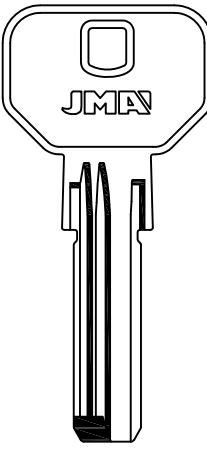
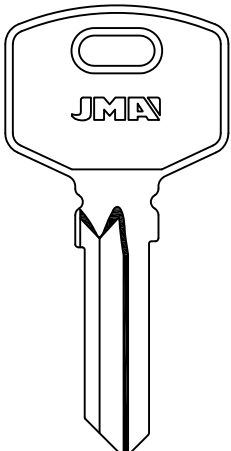
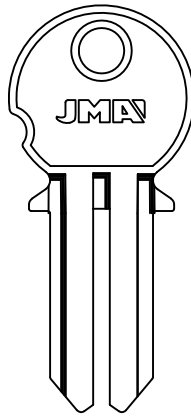
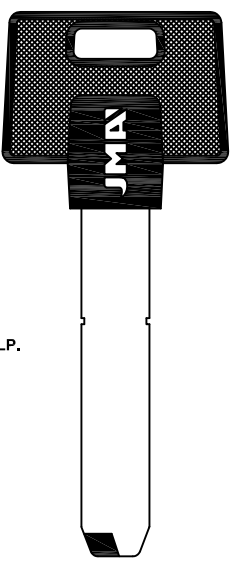
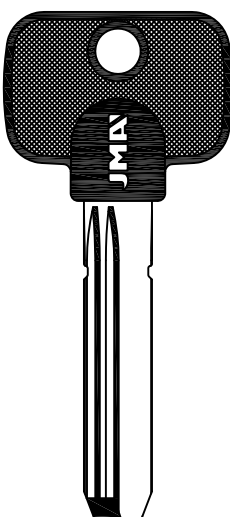
MOTTURA		M.P. PLODARI
 <p>LAT.</p> <p>MT-AG</p> <p>MT-CG</p> <p>MT-EG</p> <p>MT-GG</p>	 <p>LAT.</p> <p>MT-AG.P</p> <p>MT-CG.P</p> <p>MT-EG.P</p> <p>MT-DG.P</p> <p>MT-GG.P</p>	 <p>MP-1I</p> <p>MP-1D</p>
MSM		MSV
 <p>MSM-1D</p> <p>8.7</p> <p>2.3</p>	 <p>MSM-2D</p>	 <p>MSV-1</p> <p>MSV-2</p>
MUL.T.LOCK		
 <p>ALP.</p> <p>MUL-T2.P</p> <p>MUL-T3.P</p> <p>MUL-T4.P</p> <p>MUL-T5.P</p> <p>MUL-T7.P</p> <p>GAMMA</p>	 <p>ALP.</p> <p>MUL-T3.P1</p> <p>64</p> <p>MUL-T8.P1</p> <p>MUL-T9.P1</p> <p>JUNIOR</p> <p>MUL-T11.P1</p> <p>GAMMA</p>	





**MUL.T.LOCK**

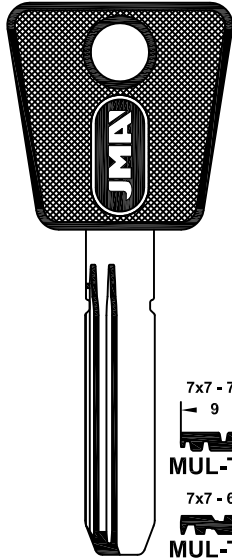
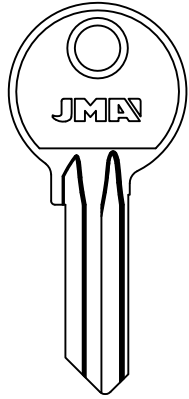

ALP.

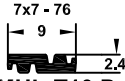

MUL-T10.P

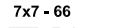

MUL-T16.P



**NATIONAL CABINET**

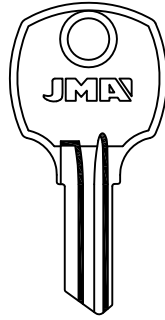

LAT.

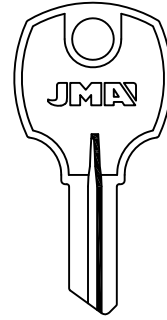

LAT.



**PARA-FOR:**

- MUL.T.LOCK (IL)
- NATIONAL CABINET (USA)
- NOVA (D)
- OCARIZ (E)
- OCTAVO M. (RUS)
- OFITA (E)
- OJMAR (E)

**NOVA**



ABUS-TOP

**OCARIZ**

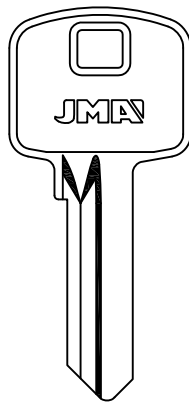

**OCTAVO M.**

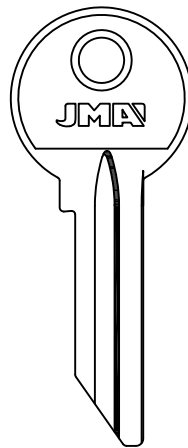

**OFITA**

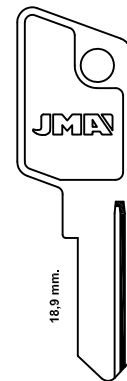

18,9 mm.



**OFITA**

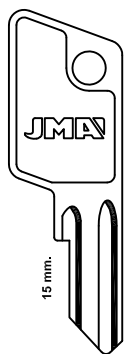

15 mm.



**OJMAR**

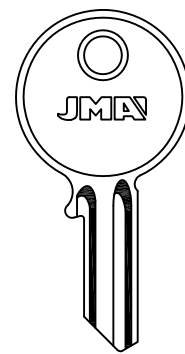
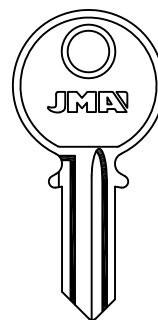
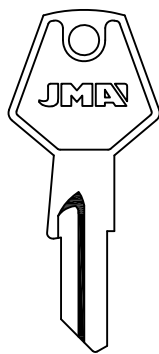

**PARA-FOR:**

OJMAR (E)

OLIVA (I)

**OJMAR**

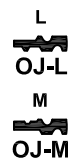
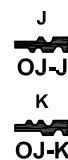
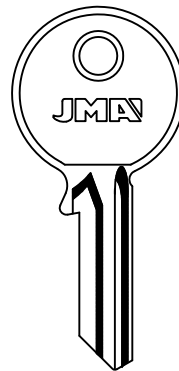
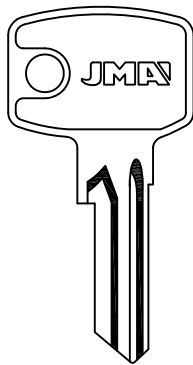
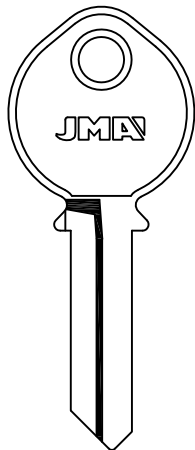

**OJMAR**

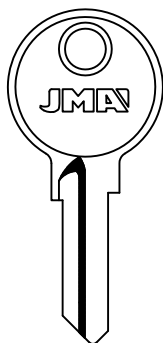

HERO-KEMEN-RS

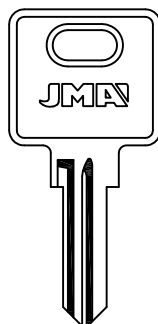

BURG-HRG-ISKU-KEMEN-MOFLEX-SISO-STUMPF METALL

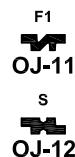
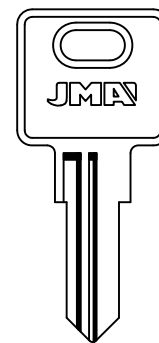

BURG

**OJMAR**

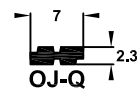
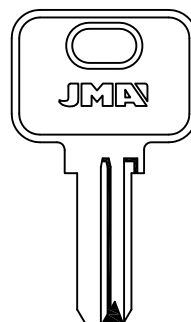
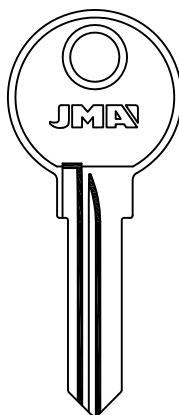
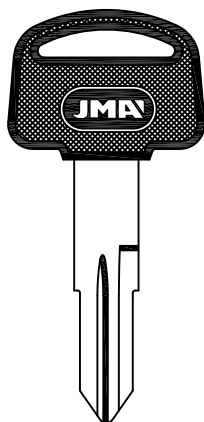

ALP.

**OLIVA**

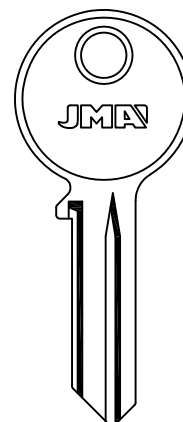



FERMABLOCK-PB-PREFER

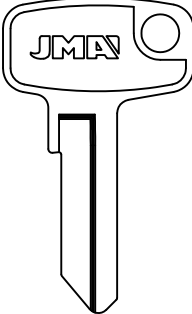
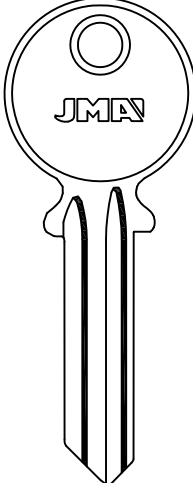
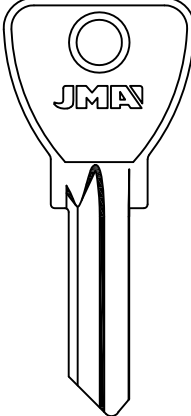
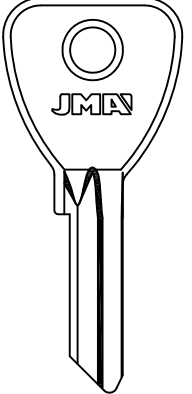

OLIVETTI	OMA	O MEC	
 <p data-bbox="159 638 239 683"><b>OLIV-1</b></p>	 <p data-bbox="462 638 542 683"><b>OA-1</b></p> <p data-bbox="470 694 534 716">C.A.R.S.</p>	 <p data-bbox="829 638 909 683"><b>OMC-1D</b></p>	 <p data-bbox="1133 638 1212 683"><b>OMC-2D</b></p>

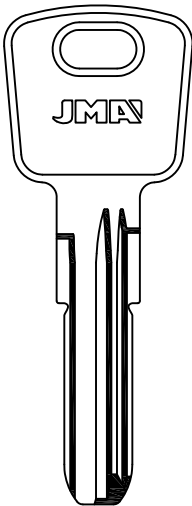
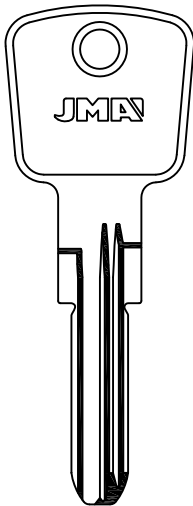
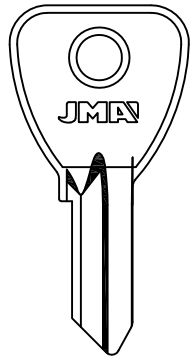
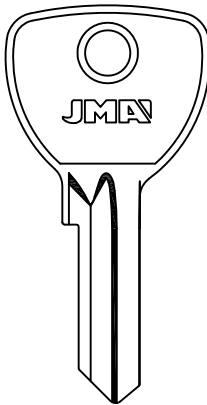
**PARA-FOR:**  
 OLIVETTI (I)  
 OMA (I)  
 OMEC (I)  
 OMIV (I)  
 O.M.R. (I)  
 ORDO (F)  
 ORION-NOVOX (F)

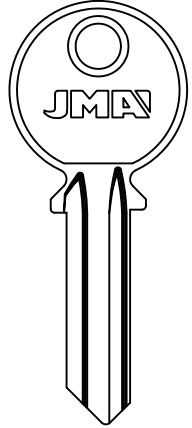
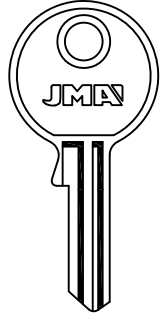

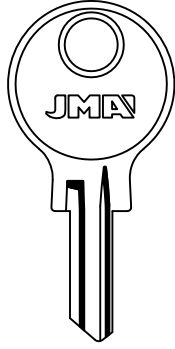
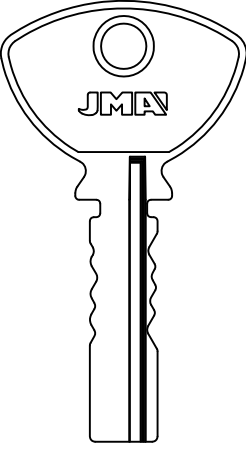







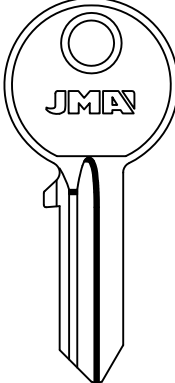
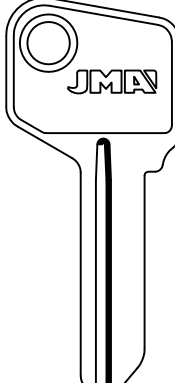
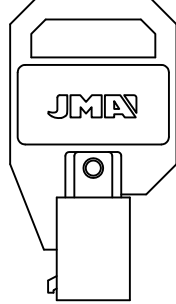
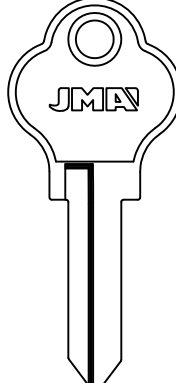

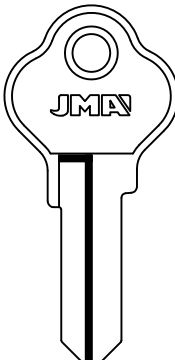
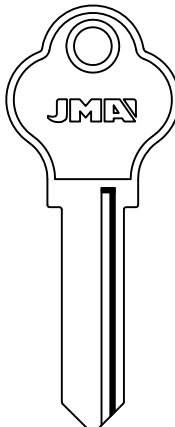
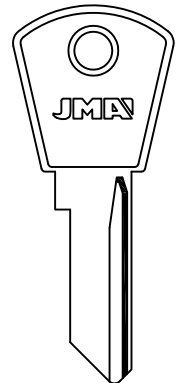
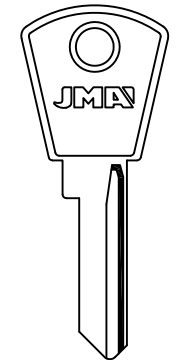

O MEC			
 <p data-bbox="295 1120 335 1142">LAT.</p> <p data-bbox="159 1332 239 1377"><b>OMC-3</b></p> <p data-bbox="167 1377 231 1400">SANTOS</p>	 <p data-bbox="598 1120 638 1142">LAT.</p> <p data-bbox="462 1332 542 1377"><b>OMC-4</b></p>	 <p data-bbox="829 1332 909 1377"><b>OMC-5D</b></p>	 <p data-bbox="1133 1332 1212 1377"><b>OMC-6D</b></p>

OMIV	O.M.R.	ORDO	ORION-NOVOX
 <p data-bbox="95 1993 167 2038"><b>OMI-1</b></p> <p data-bbox="223 1993 311 2038"><b>OMI-1D</b></p> <p data-bbox="167 2049 231 2072">CIB-STV</p>	  <p data-bbox="470 1993 534 2038"><b>OM-1</b></p> <p data-bbox="446 2049 558 2072">MICHEL SEAT</p>	 <p data-bbox="710 1993 774 2038"><b>OR-1I</b></p>	 <p data-bbox="1005 1993 1077 2038"><b>ON-1I</b></p> <p data-bbox="1141 1993 1212 2038"><b>ON-1D</b></p> <p data-bbox="1061 2049 1157 2072">DECAEUX</p>

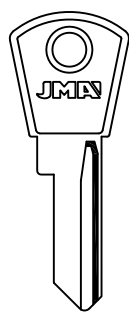
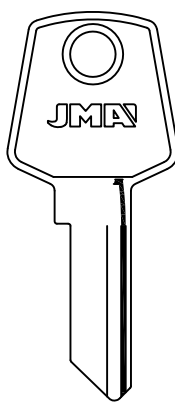
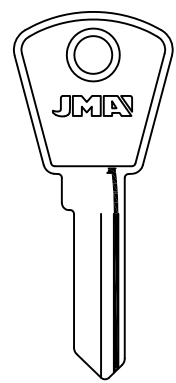
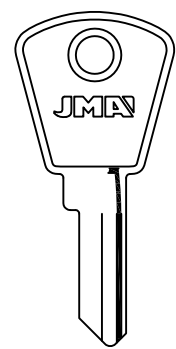

**PARA-FOR:**

- ORO (IL)
- ORSHA (RUS)
- P&C I. (USA)
- PADO (BR)
- PAPAIZ (BR)

ORO	ORSHA	P&C I.	PADO
			
 ORO-1D	 ORK-1D	 PCI-1T	 PAD-1D
PADO		PAPAIZ	
			
 PAD-2D	 PAD-3	 PAD-3D	 45-50-60-70 PAP-1
		 35 PAP-2	
PAPAIZ			
			
 25-30 PAP-3	 45-50-60-70 PAP-4	 PAP-5	 PAP-6



P.C.

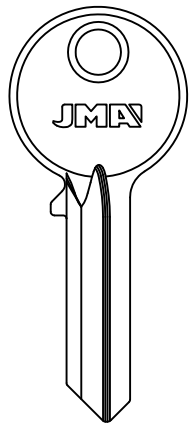

1 AL 5  
PC-1D

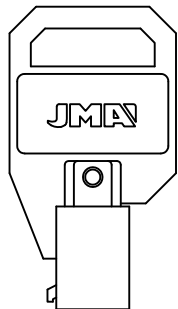

8,04 9,6  
PC-1T

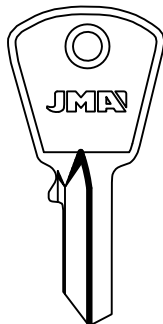

...1 AL 5  
PC-2D

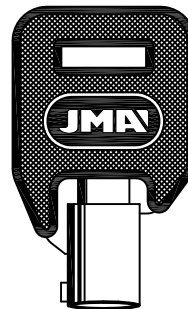

8,04 9,6  
PC-3T.P

ETNA-FEB-FPB-FRAL-SANTOS

PARA-FOR:

P.C. (I)

PENZMASH  
(RUS)

PETROZAVODSK  
(RUS)

PFAFFENHAIN  
(D)

PENZMASH

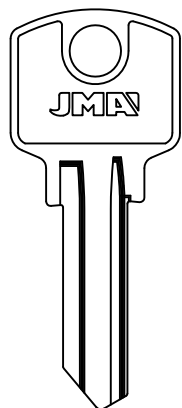

PEN-1 PEN-1D

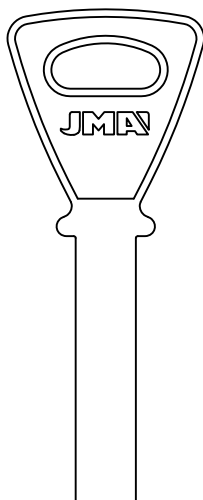

PEN-2

PETROZAVODSK

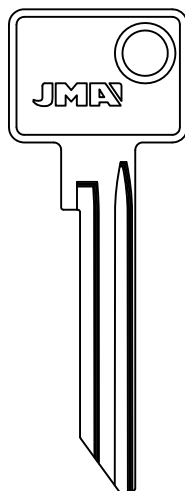

PET-1

PFAFFENHAIN

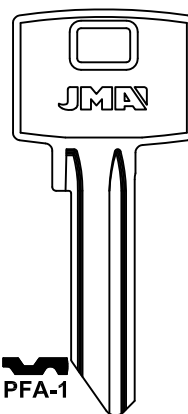

PFA-1  
KH  
PFA-2  
PFA-5

PFAFFENHAIN

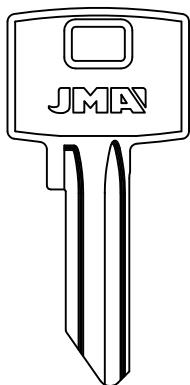

L  
PFA-3

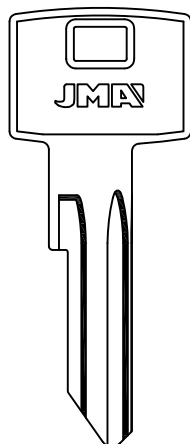

PFA-4

A21  
PFA-10D  
A22  
PFA-11D  
A23  
PFA-12D

EA  
PFA-13D  
EB  
PFA-14D  
EH  
PFA-15D  
EN  
PFA-16D  
RF  
PFA-17D  
RG  
PFA-18D

T21 AL T26-T28  
T31 AL T42  
T44 AL T46  
T51-T54-T65  
T85-T86-T91  
PFA-22 PFA-22D



**PARA-FOR:**

PFAFFENHAIN  
(D)

PHILLIPS (MEX)











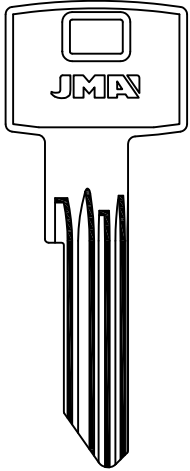
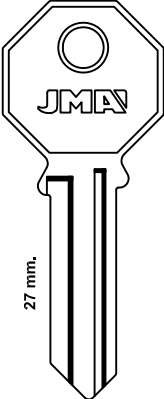
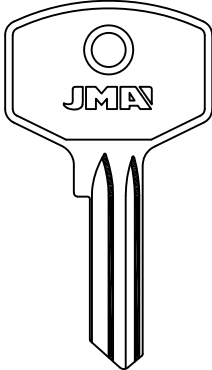







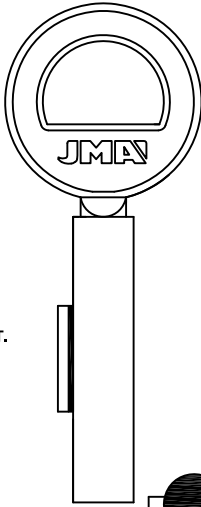
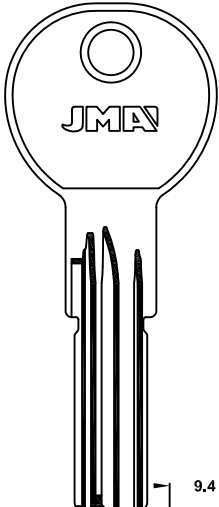
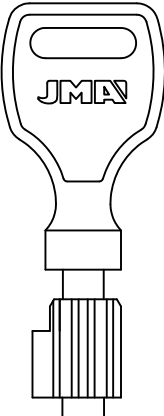
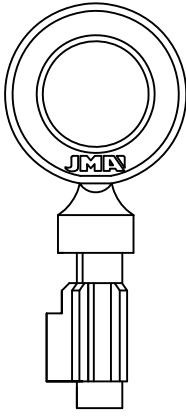

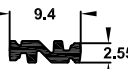

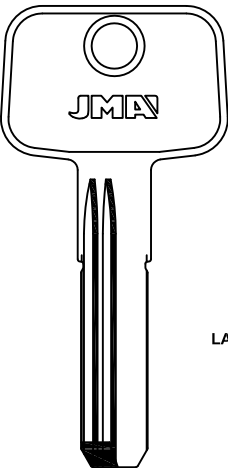
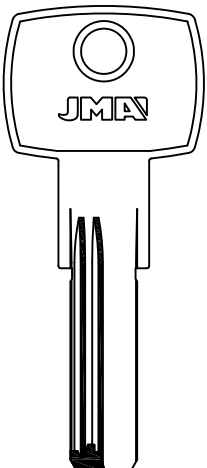
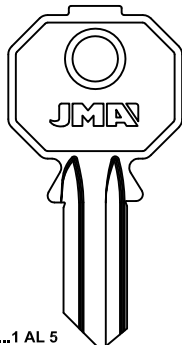
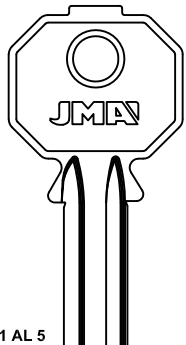

PHOENIX (GB)

PICARD (F)

POLLUX (F)

POTENT (I)

PREFER (I)

PFAFFENHAIN		PHILLIPS	PHOENIX	
		 <p>27 mm.</p>		
 PFA-6  PFA-6D  PFA-21		 PHI-52	 PHO-1	
			 A21 PFA-7D  A22 PFA-8D  A23 PFA-9D	
PICARD		POLLUX		
 <p>LAT.</p>  <p>LAT.</p>		 <p>LAT.</p>  <p>LAT.</p>		
 PIC-1E  PIC-8D <p>9.4 2.55</p> <p>ISEO</p>		 POL-3TEC  POL-5TEC  POL-4E		
POTENT		PREFER		
 <p>LAT.</p> 		 <p>...1 AL 5</p>  <p>...1 AL 5</p>		
 PTN-1D <p>8.6 2.4</p>		 PR-1  PR-1D  PR-4I  PR-4D  PR-2  PR-10  PR-3  PR-11 UNIFOR BLOCUS-CAP-CIB-JIP PASTORE-PROMO		
 PTN-2D <p>P04..... 1-2-3-4-5-6</p>				



**PREFER**

**PARA-FOR:**

PREFER (I)  
REGAL (GB)  
RENZ (D)

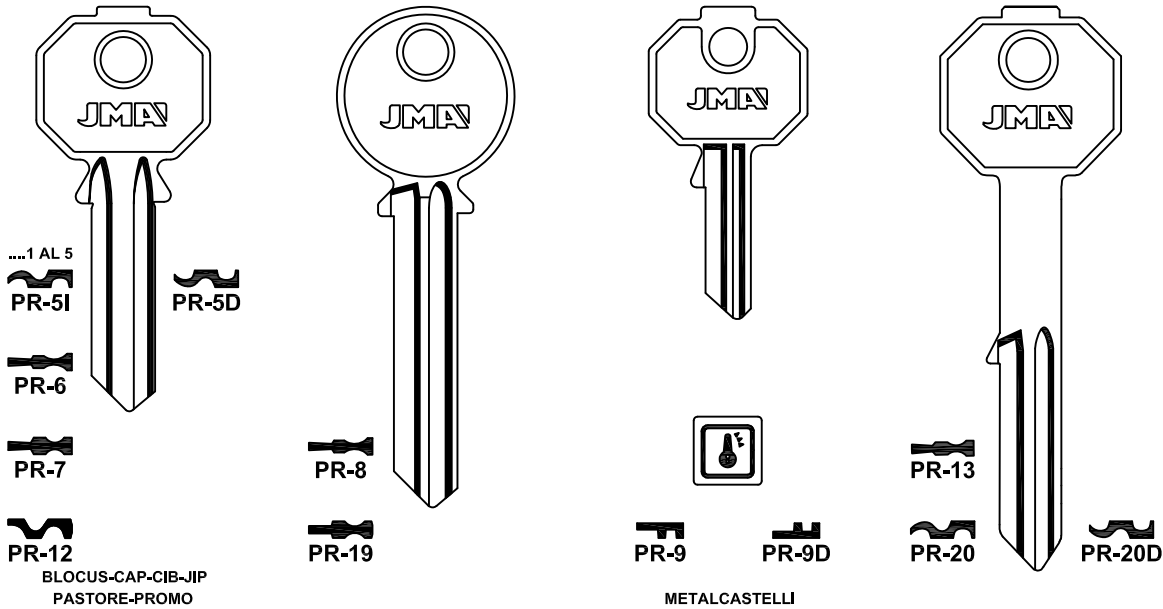

**PREFER**

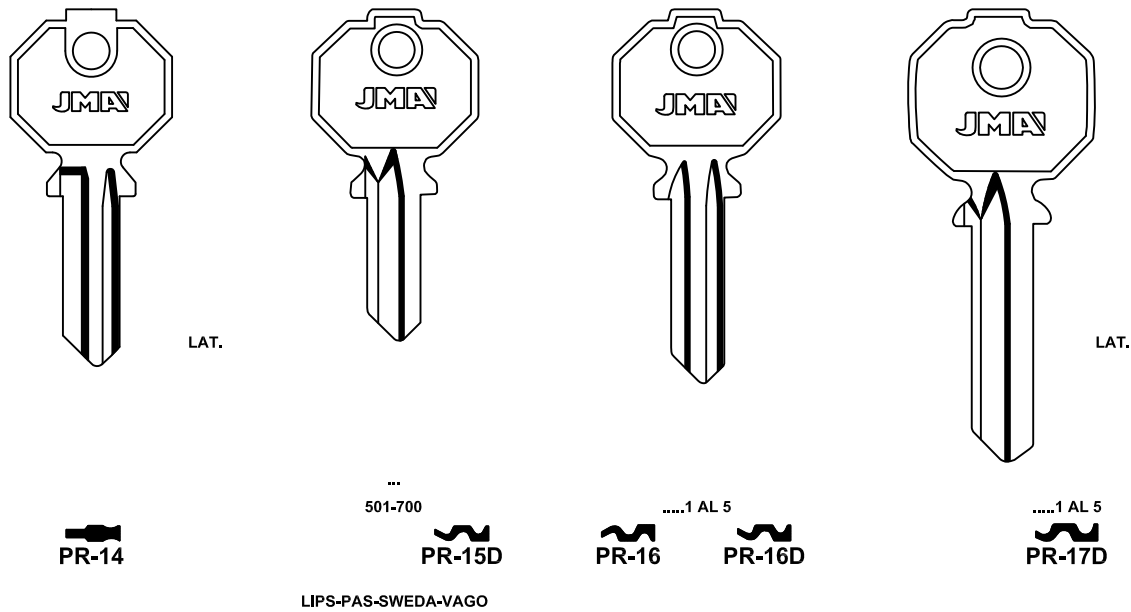

**PREFER**

**REGAL**



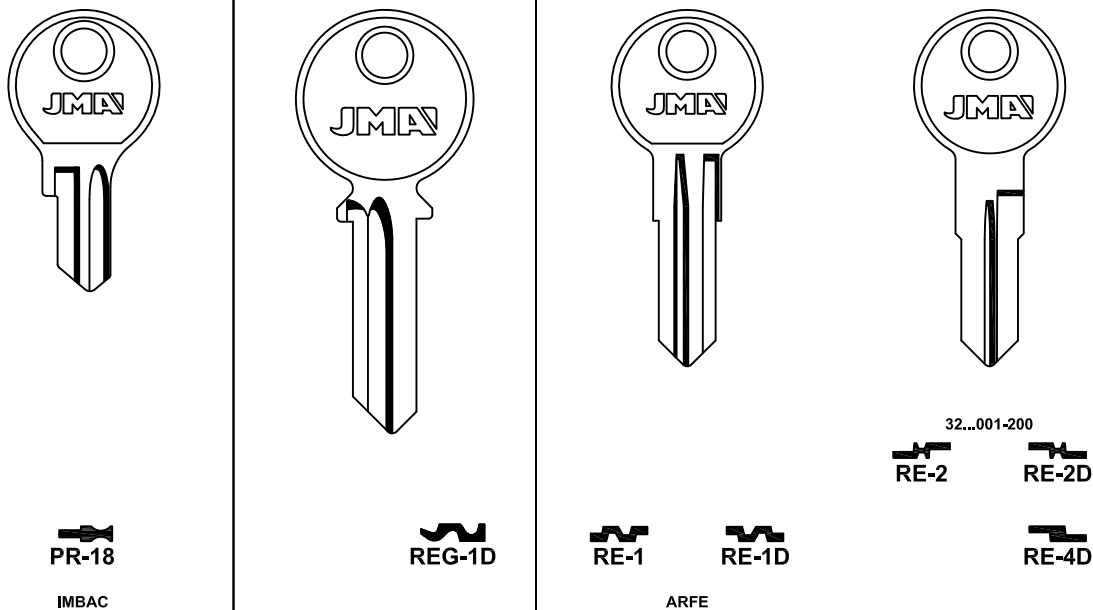







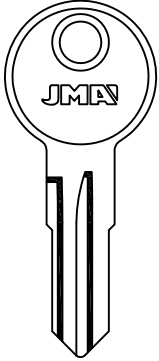
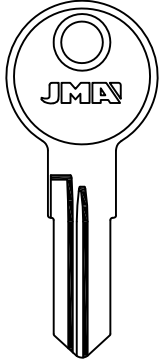
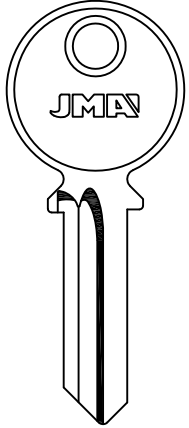
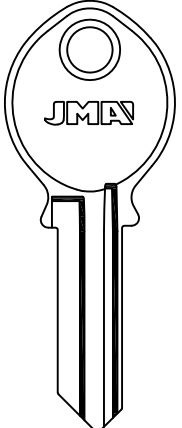





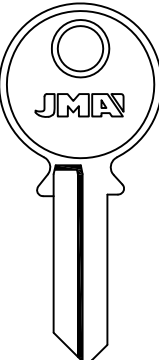

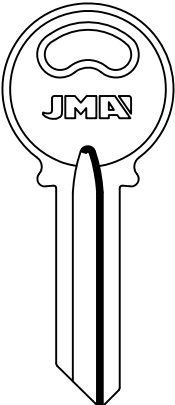
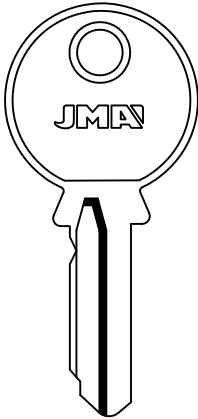
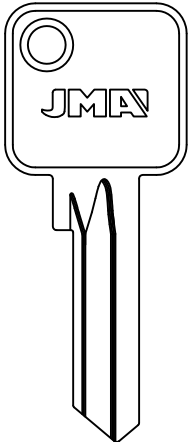

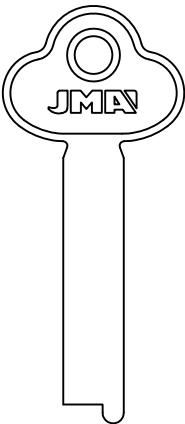
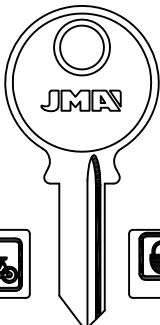

**RENZ**

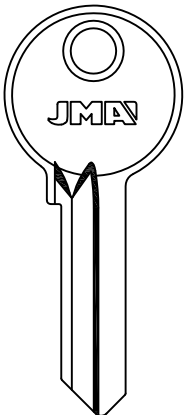



**PARA-FOR:**

- RENZ (D)
- REX (DK)
- RGM (E)
- RIAZIAN (RUS)
- RICOUARD (F)
- RIGA (RUS)
- RIL (E)
- RIPA (E)
- RITA

RENZ		REX	RGM	
 			 	
 RE-3D  RE-5D		 REX-1D	 RGM-1I  RGM-1D	
RGM	RIAZIAN	RICOUARD	RIGA	
 				
 RGM-2	 RAZ-1D	 RIO-1D COUILLET-DECAYEUX-KIFERM LAS-PASSY-YVEL	 RIG-1D	
RIL	RIPA	RITA		
	  			
 26-M	 RI-1I  RI-1D  RI-2I  RI-2D  RI-3I  RI-3D ABUS-FADE	 RIT-1D		



# RONIS

PARA-FOR:  
RONIS (F)

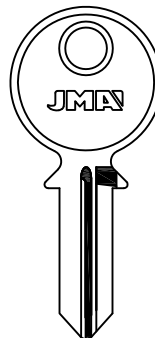
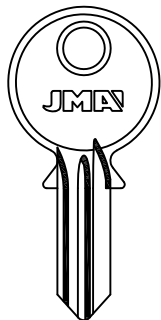

A8..AA-DS  
..8AB-ZZ  
S...385-402



A9..AA-DS  
..8AB-ZZ  
S...403-420



..4AB-ZZ  
S...331-348



RO-2I

..3AB-ZZ  
....1 AL 4



RO-2D

AA-JZ  
A4../A.4.



RO-4I

AA-JZ  
A3../A.3.  
S...213-246



RO-4D

AB-ZZ  
..6  
S...349-366



RO-6I

AB-ZZ  
..7  
S...367-384



RO-6D



C4..AA-ZY  
D4..AA-HR



RO-5I

C3..AA-ZY  
D3..AA-HR  
J...1-544



RO-5D

ABSA-FROSER-PJ-SADV

ABSA

# RONIS

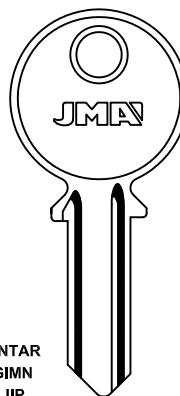
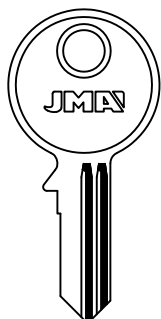

ARMOR  
EMHART  
FORINDEX  
KARDEX  
MLM  
NEMEF  
RONEO  
SANEL STRAFOR  
SCHAFFER  
YAC

...11 1-700  
A...A1-700  
C...101-600  
D...1-1000  
T...1-380  
E...1-1000  
T...107-400  
Y...101-600



RO-8I

T...1-380  
TA...1-224  
GV...1-300  
...F1-500  
1F..1-21



RO-8D

F...1-500



RO-30

...0 AL 8



RO-30D

...151-700  
E...1-1000  
T...107-400  
Y...101-600



RO-32D

...11 1-700  
A...A1-700  
C...101-600  
D...1-1000  
T...1-380  
TA...1-224  
GV...1-300  
...F1-500  
1F..1-21



RO-33

ANTAR  
GIMN  
JIP  
LAPERCHE  
PM  
SESA



RO-9I



RO-9D

...151-700  
E...1-1000  
T...107-400  
Y...101-600



RO-7I

TA...1-224  
GV...1-300  
...F1-500  
1F..1-21



RO-7D

# RONIS

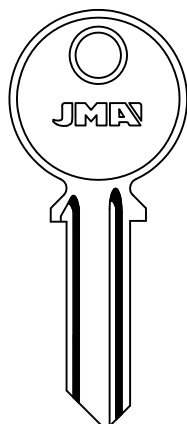

FM  
RO-18I  
LIONA LIOX-LAPERCHE



RO-19I

LAPERCHE



RO-19D



RO-20I

FONTAINE-LAPERCHE



RO-20D



RO-21I



RO-21D



RO-22I

RO-22I

## RO-10D

ANTAR  
BLOCUS  
BAB  
DEBEAURAIN  
DELTA  
DERLOCHE  
DESPREZ  
DC  
EMGE  
EQUIBATIR  
FONTAINE  
FORINDEX  
GOLLOT  
GUIDOTTI  
JIP  
LAPERCHE  
LIONA-LIOX  
MAFOR  
MONDIAL  
MOREAUX  
NUMIDIA  
PM  
SESA  
STREMLER  
STUV  
VEGA

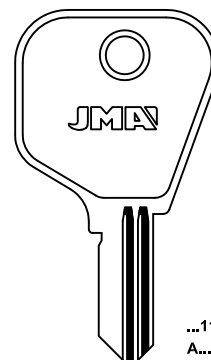

...151-700  
E...1-1000  
T...107-400  
Y...101-600



RO-11I

...11 1-700  
A...A1-700  
C...101-600  
D...1-1000  
T...1-380  
TA...1-224  
GV...1-300  
...F1-500  
1F..1-21



RO-11D

.....1 AL 9  
A/Z.....1 AL 8  
.....A/Z 1 AL 8  
MX....1100-1699



RO-10I



RO-10D



RO-23D

ABSA-SADV-SIMPLEX



**PARA-FOR:**

- RONIS (F)
- ROSSETTI (I)
- ROYAL (RC)
- RUKO (DK)

**RONIS**

**RO-12I**    **RO-12D**  
 M...601-983    TAV  
**RO-16I**    **RO-16D**  
 BURG-STRAFOR

....1-1296  
 .....0 AL 9 AL 0  
 .....1 AL 9  
**RO-24I**    **RO-24D**  
 ANTAR-LAPERCHE-SESA

**FM**  
**RO-25I**    **RO-25D**  
 LAPERCHE

**FL**  
**RO-26I**    **RO-26D**  
 LAPERCHE

**FK**  
**RO-27I**    **RO-27D**  
 LAPERCHE

**RO-28I**    **RO-28D**  
**RO-29D**    **RO-31D**  
 SOLOR

**RONIS**

**RO-34D**    **RO-36D**  
 CATOR    JD

**RO-37**    **RO-37D**    **RO-39**  
**RO-38**    **RO-38D**    **RO-40**    **RO-40D**  
**RO-41**    **RO-42**

**ROSSETTI**

**ROYAL**

**RUKO**

**ROSE-1**    **ROY-1**    **RU-1D**  
 LAT.    ALU.    \* LAT.

.....1 AL 8  
 .....1 AL 9  
 .....1 AL 9 AL 0 A-B  
 .....0 AL 9 A AL M  
 S.....1 AL 9  
**RU-2I**    **RU-2D**  
**RU-3D**  
**RU-4D**  
**RU-10D**  
 \* **RU-19D**  
**RU-TL**

DIFA



## RUKO

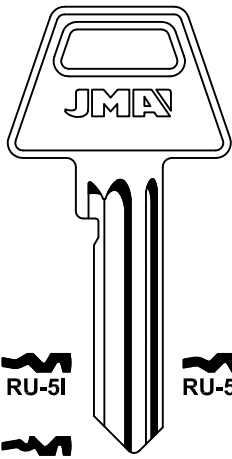

RU-5I

RU-6I

RU-9I

RU-5D

RU-9D

RU-K

RU-L

RU-M

SKB  
RU-11D

RU-12D

RU-14D

RU-15

RU-KD

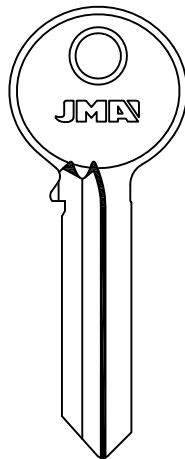

RU-7D

.....  
1 AL 9 A AL C  
RU-8D

GK  
RU-GK7

GL  
RU-GL7

GM  
RU-GM7

GS  
RU-GS7

ASSA

## RUKO

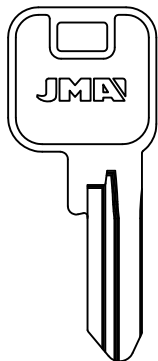

RU-13D

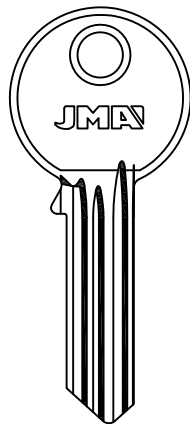

GC  
RU-GC

GK  
RU-GK  
GL  
RU-GL

GS  
RU-GS

HNR  
RU-16D

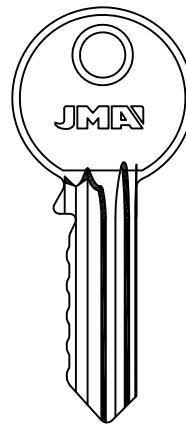

GM  
RU-GM

ASSA

## RUSSIA

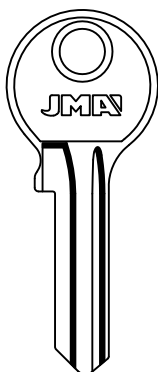

RSS-1

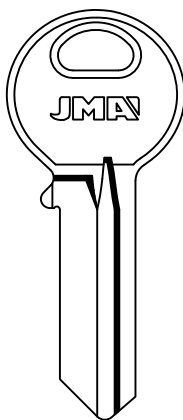

RSS-2D

## RUSSWIN

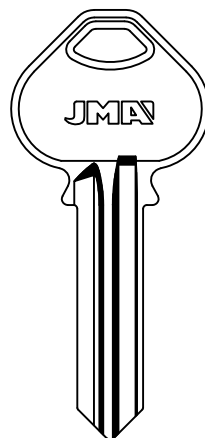

RUS-1

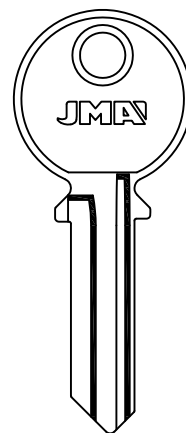

RUS-2

LAT.

PARA-FOR:  
RUKO (DK)  
RUSSIA (RUS)  
RUSSWIN (USA)



**PARA-FOR:**

- SABT (KW)
- SAM (RUS)
- SAMSONITE (USA)
- SARGENT (USA)

SABT	SAM		SAMSONITE
 SABT-1	 SAM-1D	 SAM-2D	170 S  SA-1 SA-1D

SAMSONITE		SARGENT	
 SA-2	 SA-3I SA-3D	SE 041 SE 052 SE 083 SE 124 SE 165 SE 186  SA-4	LN      RN      S  SAR-1 SAR-1D SAR-2D

**SARGENT**

LAT.	LAT.	LAT.	LAT.		
 SAR-3D	 SAR-4	 SAR-4D	 SAR-5D	LN      RN      S  SAR-6 SAR-6D	



**SATURN**

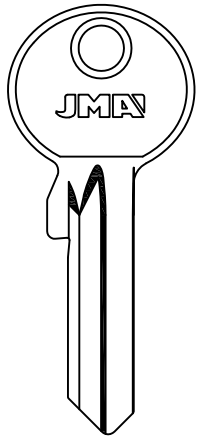

SAT-1D

GERA-VERA

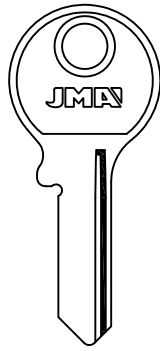

SAT-2

**SCHÄRER**

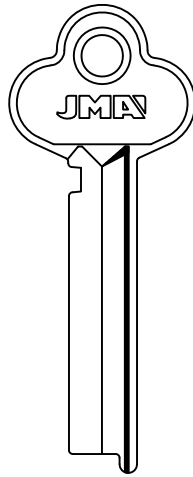

SHR-1

LAT.

**SCHLAGE**

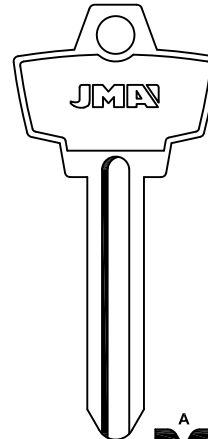

A  
SLG-1

W  
SLG-2

EPO

**PARA-FOR:**

- SATURN (D)
- SCHÄRER (USA)
- SCHLAGE (USA)
- SCHLECHTENDAHL (D)
- SCHUCO (D)
- SEA (CH)

**SCHLAGE**

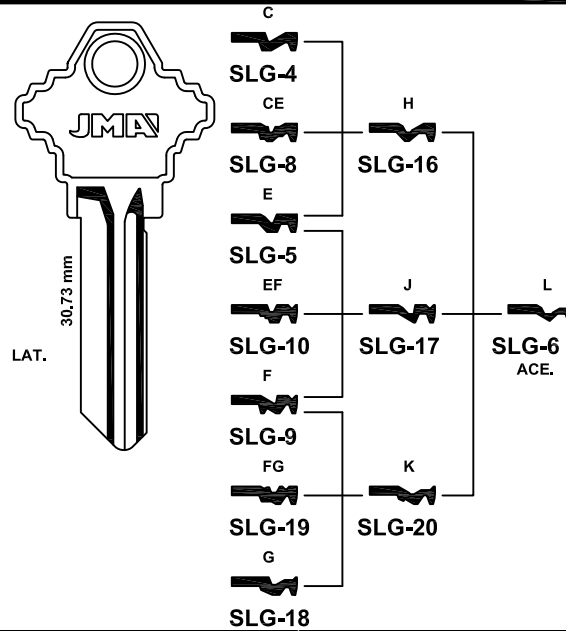
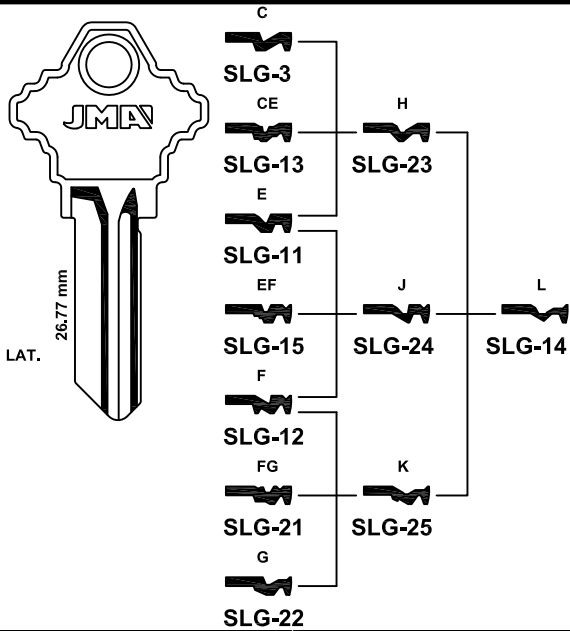

**SCHLAGE**

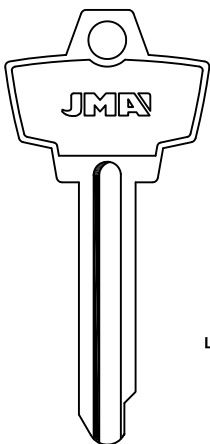

A  
SLG-7

LAT.

**SCHLECHTENDAHL**

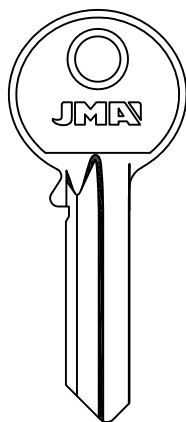

SCH-1D

CASI-HUTRA-NORDWEST

**SCHUCO**

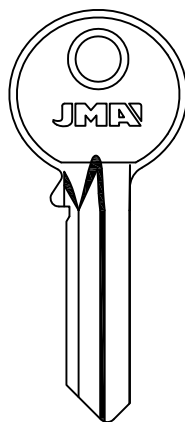

SCC-1D

**SEA**

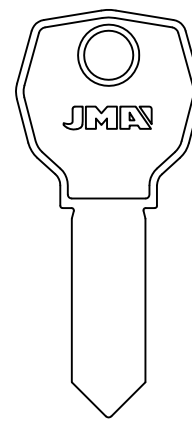











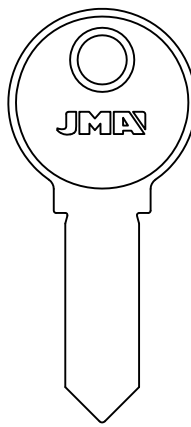
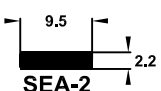
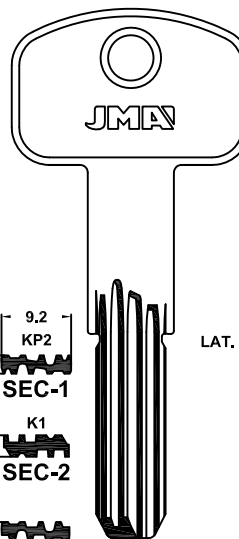
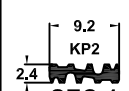

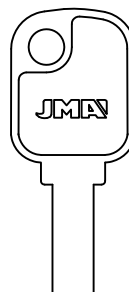

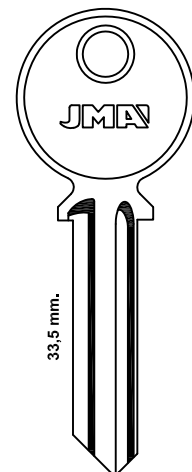

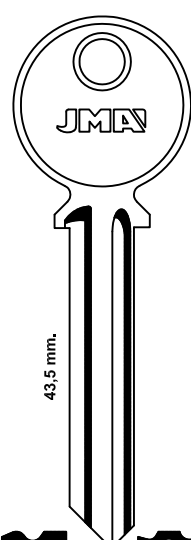

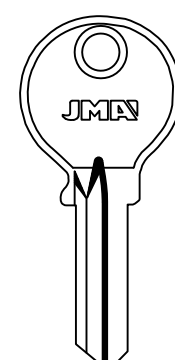

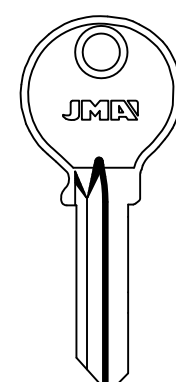

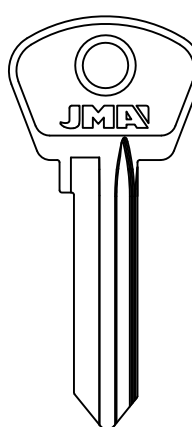
9.5  
20-23  
2.2  
SEA-1

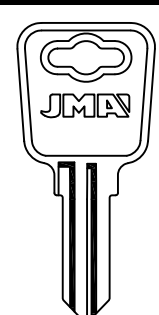
EZCURRA-HASLER-VIDMAR

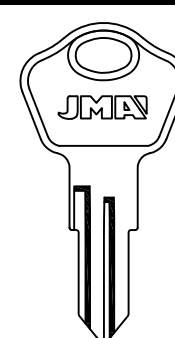

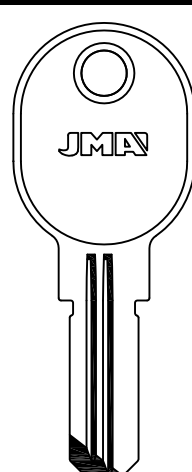

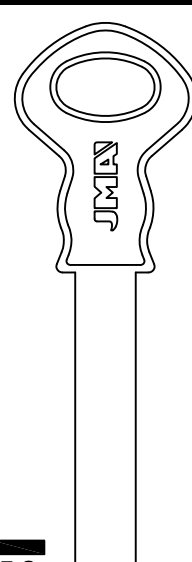





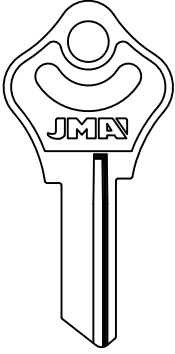

**PARA-FOR:**

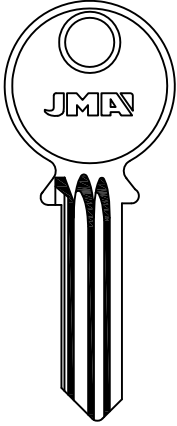
- SEA (CH)
- SECUREMME (I)
- SECURITAL (I)
- SELECT (F)
- SELIVANOVSK (RUS)
- SENTRY SAFE (USA)
- SERRALLER (E)
- SERRETA (E)

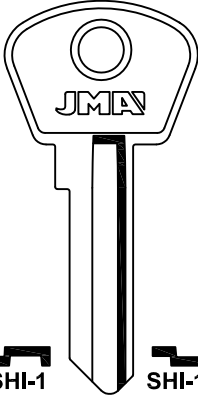



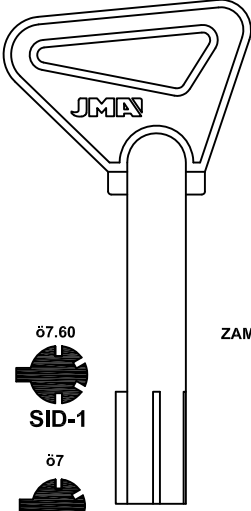



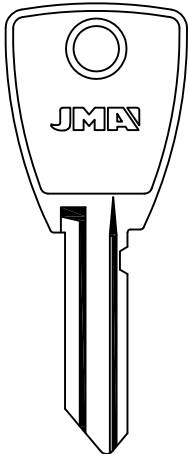

SEA	SECUREMME	SECURITAL	SELECT
 <p>LAT.</p>  <p>.....1 AL 7</p> <p>9,5      2,2</p> <p><b>SEA-2</b></p> <p>EZCURRA-HASLER-VIDMAR</p>	 <p>LAT.</p>  <p>9,2 2,4 <b>SEC-1</b></p>  <p>K1 2,85 <b>SEC-2</b></p>  <p>2,37 <b>SEC-3</b></p>	 <p>LAT.</p>  <p>5,46      1,9 <b>SCR-1</b></p> <p>KYR</p>	 <p>ZAM.</p> <p>33,5 mm.</p>   <p><b>SEL-1I      SEL-1D</b></p>
SELECT			SELIVANOVSK
 <p>43,5 mm.</p>   <p><b>SEL-2I      SEL-2D</b></p>	  <p><b>SEL-3D</b></p>	  <p><b>SEL-4D</b></p>	  <p><b>SL-1</b></p>
SENTRY SAFE	SERRALLER	SERRETA	
 <p>LAT.</p>  <p><b>SEN-1D</b></p>	 <p>LAT.</p>  <p><b>SEN-2D</b></p>	 <p>LAT.</p>  <p><b>SER-3D</b></p>	  <p><b>7-S</b></p>

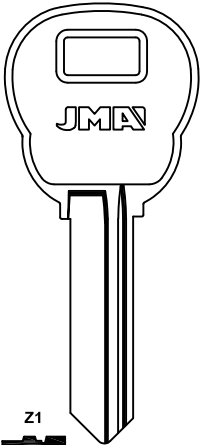



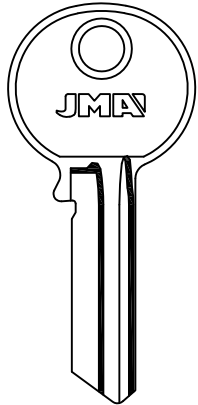

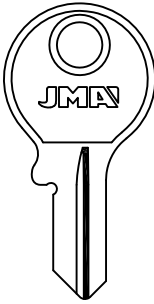



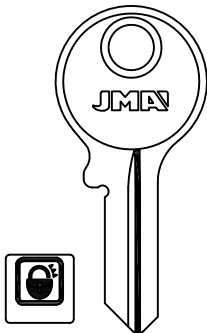

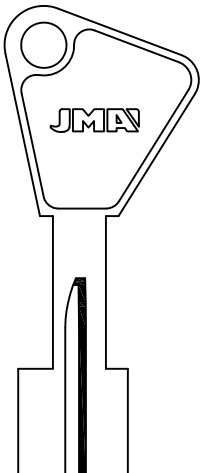

SHANGAI	SHAW	SHILUTE	SIDESE
  CINA	 04  HTV-VAUGHN-YALE	    	 ZAM.   ø7.60 ø7

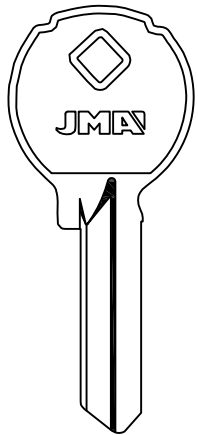
**PARA-FOR:**  
 SHANGAI (RC)  
 SHAW (GB)  
 SHILUTE (RUS)  
 SIDESE (E)  
 SIMECA (CH)  
 SIS (I)

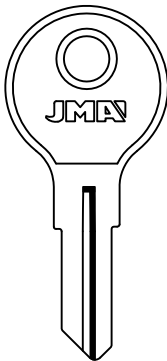
SIMECA			SIS
  GUTLER-KATE-ORBA SIAM-SIMATIC	 Z1  40   GUTLER-KATE-ORBA SIAM-SIMATIC	  	  FEL

SIS			
     UTZ-ZENITH	 	 LAT.  LÅSBOLAGET	 

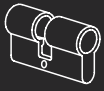

**PARA-FOR:**

- SIS (I)
- SISO (I)
- SJL (RUS)
- SOFER (P)
- SOFI-SONAFI (P)
- SOLER (E)
- SOPRANO (BR)

		SIS		SISO		SJL	
				EVERGOOD-JOMA			
SOFER		SOFI-SONAFI					
	26.4 mm						
SIL							
SOFI-SONAFI		SOLER		SOPRANO			
				90 mm			



**SOS**

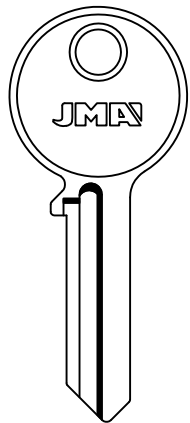

 SOS-1D

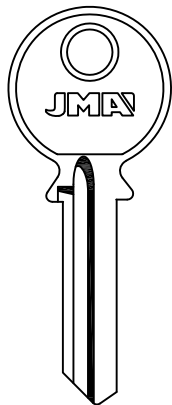

 SOS-2D

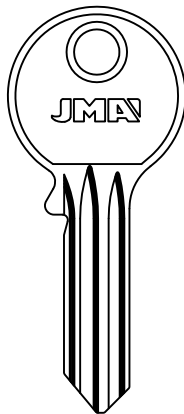

 SOS-3

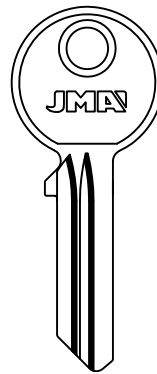

 SOS-4D

**PARA-FOR:**

SOS (F)

SPIDER (IL)

SQUIRE & SONS  
(GB)

**SOS**

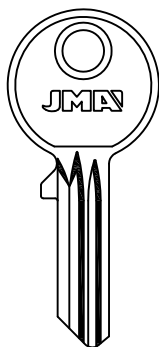

 SOS-5

**SPIDER**

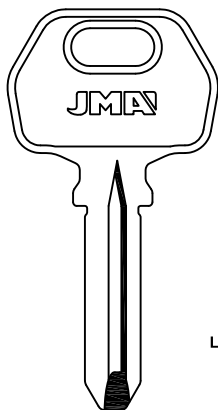

LAT.

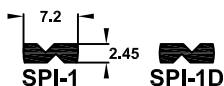

SPI-1 SPI-1D  
CAVERS-CODKEY-LOCKSYS

**SQUIRE & SONS**

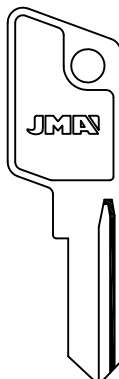

 SQ-1

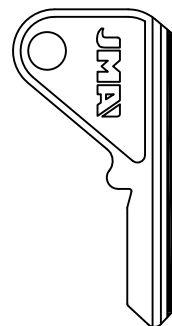

 SQ-2

**SQUIRE & SONS**

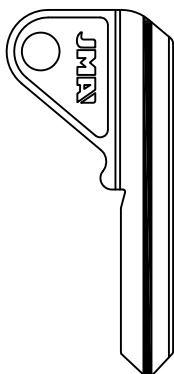

 SQ-3D

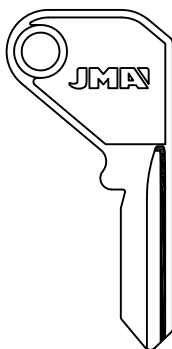

 SQ-4

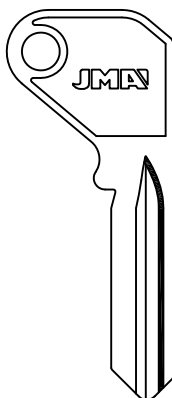

 SQ-5D

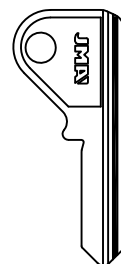

 SQ-6



**PARA-FOR:**

SQUIRE & SONS  
(GB)

STA-LOCK (GB)

STAR (J)

STARLET (D)

STEKLOMASH  
(RUS)

**SQUIRE & SONS**

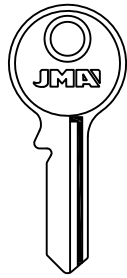

**SQ-7**

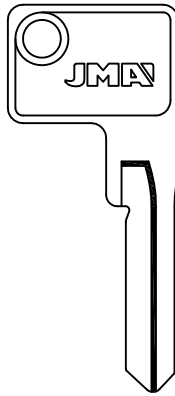

**SQ-8D**

**STA-LOCK**

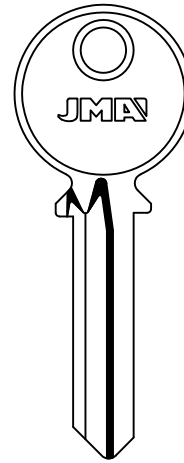

**STL-1D**

SECURE

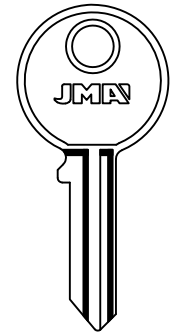

**STL-2I**

SECURE

**STAR**

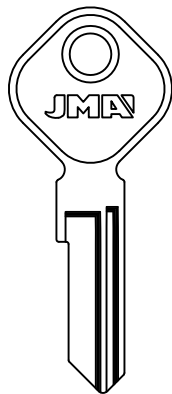

K...  
1-1600  
**STA-1**

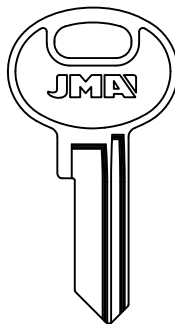

**STA-1D**

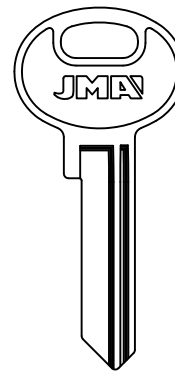

**STA-2**

**STA-2D**

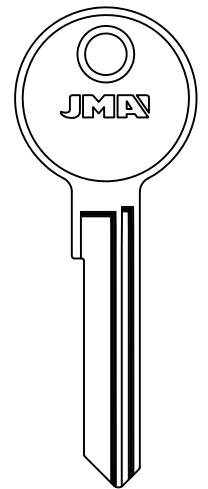

**STA-3**

**STA-3D**

**STA-4**

**STA-4D**

**STAR**

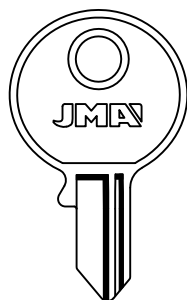

**STA-5**

**STA-5D**

**STARLET**

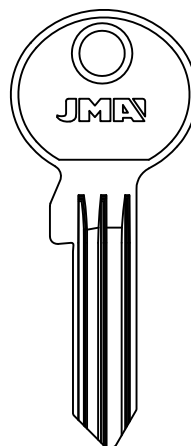

**ST-1I**

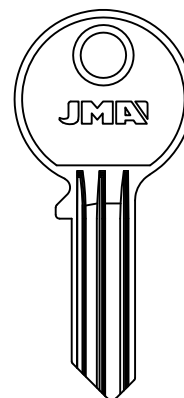





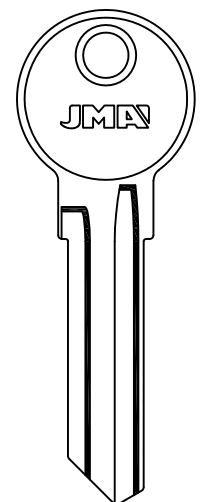





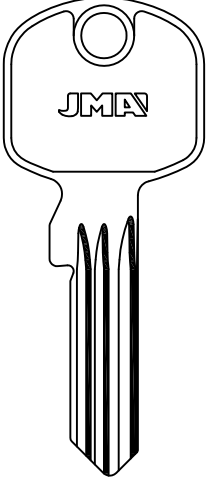

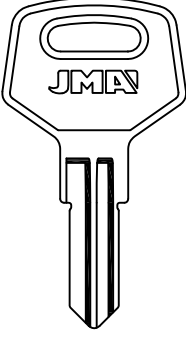
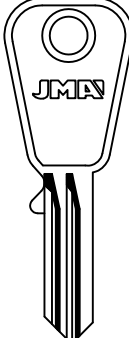





**ST-2**

**STEKLOMASH**











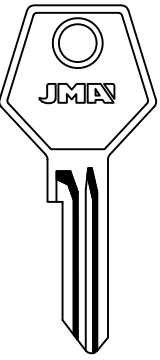
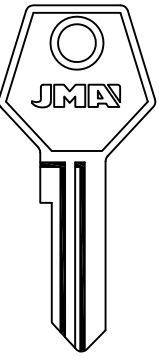
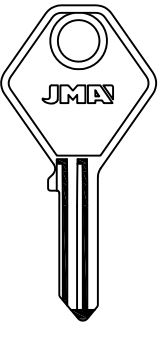
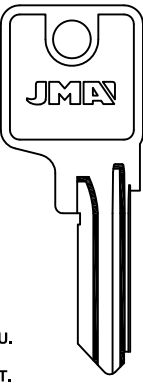









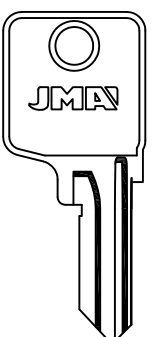
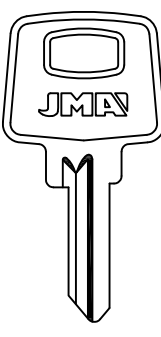

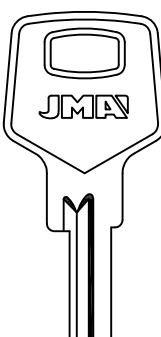
**STK-1**



STEM			STERLING	STREBOR
	 STE-8D			
	 STE-7	 STE-14D		
	 STE-6	 STE-13D		
	 STE-5D	 STE-12		
	 STE-4	 STE-11		
	 STE-3	 STE-10		
 STE-1	 STE-2D	 STE-9D	 STG-1	 STR-1
GE GE				

**PARA-FOR:**  
 STEM (D)  
 STERLING (GB)  
 STREBOR (GB)  
 STS (E)

STREBOR			STS	
				
			ALU. LAT.	
 STR-2 INNOCENTI	 STR-4	 STR-5	 STS-1I	 STS-1D
TS...300-369	S..1-70		 STS-28	 STS-1D.P

STS				
				
				
 STS-3I	 STS-3D	 STS-4D	 STS-4D.P	 STS-6D
SEMEL	BTM	BTM	BTM	



**PARA-FOR:**

STS (E)

STUBLINA (SCG)

STUMPF (D)

STUV (D)

**STS**

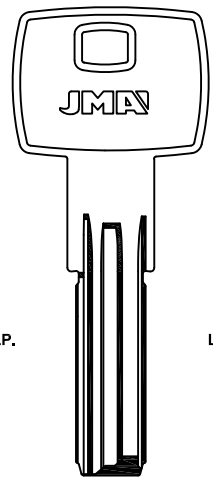
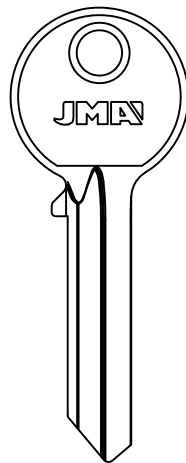
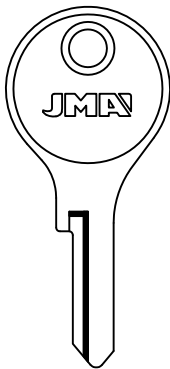
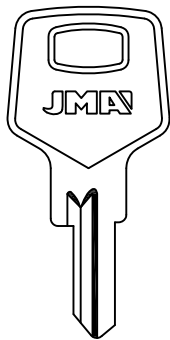

STS-7D

BTV

STS-12D

DAD

STS-13D

STS-21D

STS-35

MEGA6  
STS-38

ALP.

LAT.

**STS**

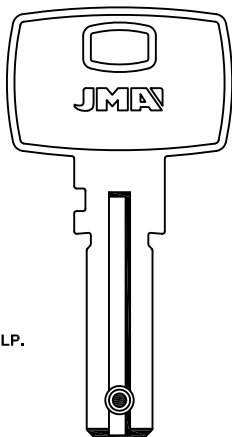

ALP.

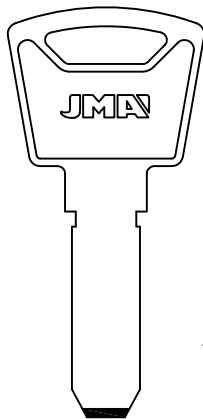

CAYS

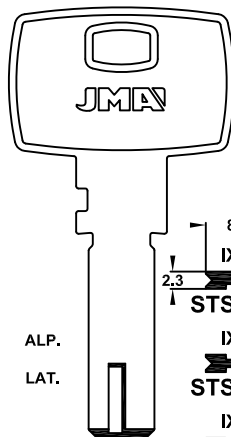

ALP.

ALP.

LAT.

DOM-ESAFE  
FAC-IFAM  
SERRALLER  
TECSESA  
TECNOLAR

IX-3  
2.3  
8.5  
STS-TV3

IX-5

STS-TV5

IX-8

STS-TV8

IX-9

STS-TV9

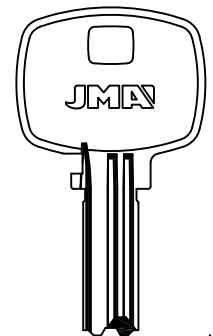

LAT.

IX-BOLA  
8.5  
2.3  
STS-B1

8.8  
2.3  
STS-T14

7.1  
2.3  
STS-X5

**STS**

**STUBLINA**

**STUMPF**

**STUV**

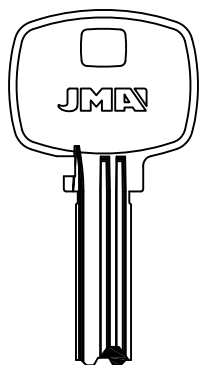

LAT.



7.1  
2.3  
STS-X6

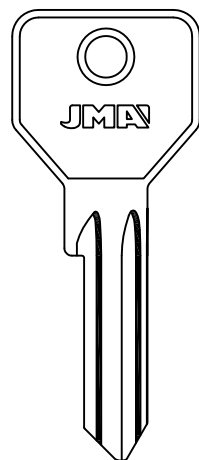

STB-1

STB-1D

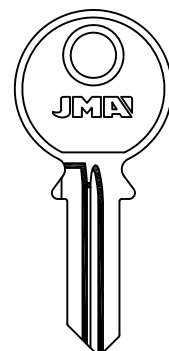

STF-1

STF-1D

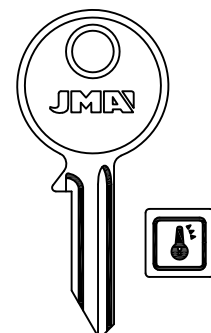

1F...201-278  
1F...Z201-278  
1F...X201-278

2F...  
201-278

STUV-1I

STUV-1D

9F  
STUV-3

DOM-MLM



**STUV**

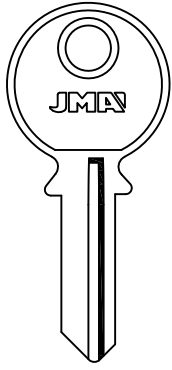

**STUV-2**

**SUREX**

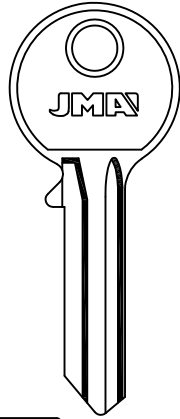

**SR-1I**

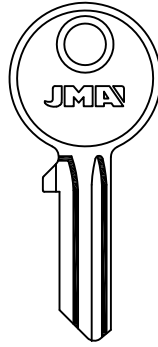

**SR-2**

ATLAS

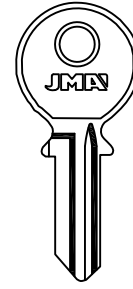

**SR-3**

ATLAS-EUROP-MATTEY

**PARA-FOR:**

- STUV (D)
- SUREX (F)
- T-KEY
- TAITO (J)
- TALLINN (RUS)

**SUREX**

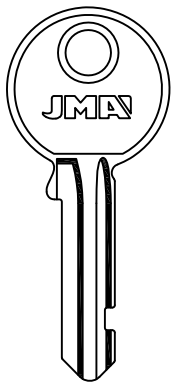

**SR-4**

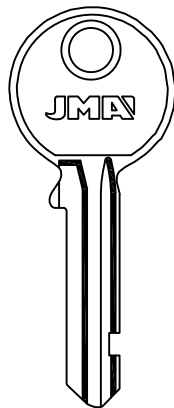

**SR-5**

**T-KEY**

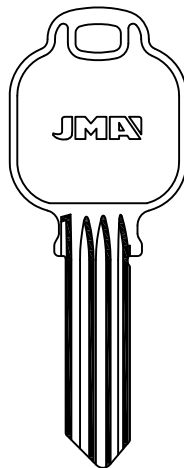

**TKY-1**

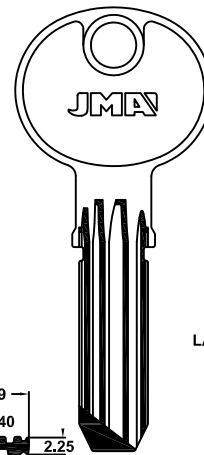

**TKY-2**

LAT.

**TKY-3**

BAILING LOCK

**TAITO**

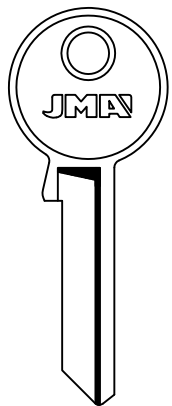

**TAI-1**

**TALLINN**

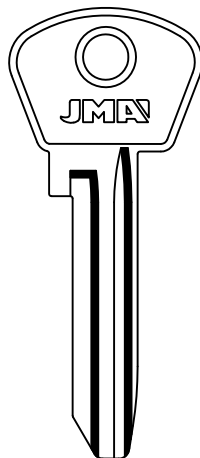

**TAL-1**

**TAL-1D**

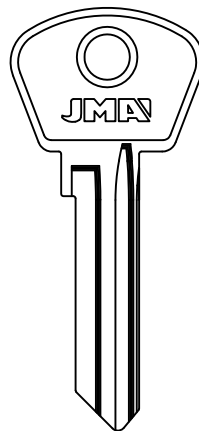

**TAL-2**

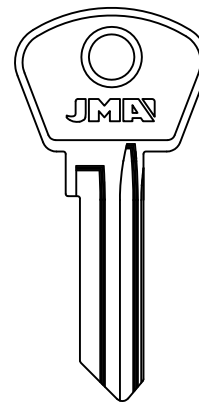

**TAL-3**





**PARA-FOR:**

- TARONI (I)
- TAYLOR (USA)
- TECON (E)
- TECSESA (E)
- TEICOCIL (P)
- TEKA (S)
- TEM (E)
- TESA (E)

	TARONI	TAYLOR	TECON	
	<p>LAT.</p> <p>TRO-1 TRO-1D</p>	<p>TAY-1</p>	<p>LAT.</p> <p>TC-1 TC-2</p>	<p>TC5</p>
	TECSESA	TEICOCIL	TEKA	TEM
	<p>ALP.</p> <p>TEC-2</p>	<p>TEI-1D</p>	<p>20104 20004</p> <p>TK-2I TK-2D</p> <p>ASSA-ERMEX-LM</p>	<p>TEM-I35 TEM-D35</p>
	TEM	TESA		
	<p>TEM-I55 TEM-D55</p> <p>CORSA</p>	<p>* LAT.</p> <p>TE-1I TE-1D</p>	<p>TE-3</p> <p>MR</p>	<p>TE-4</p> <p>IFOS</p>



## TESA

PARA-FOR:

TESA (E)

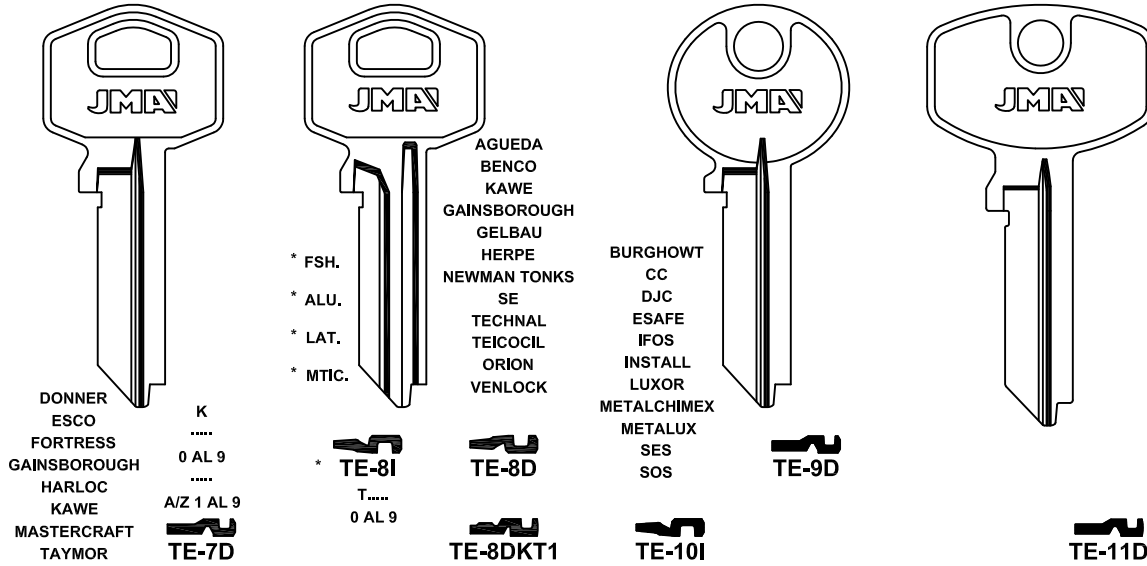

## TESA

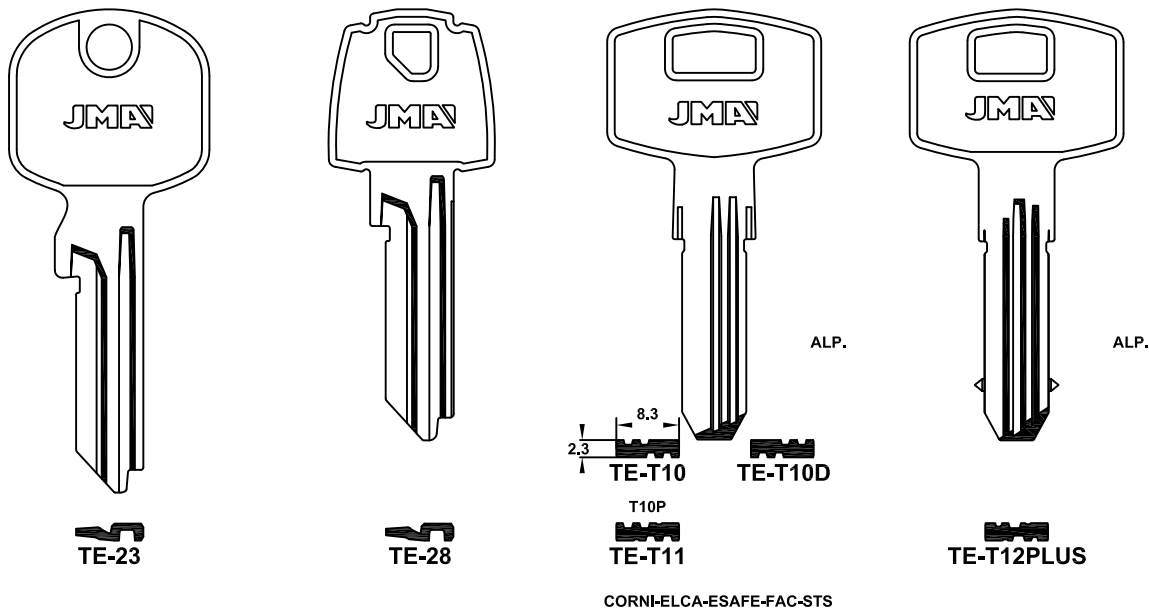



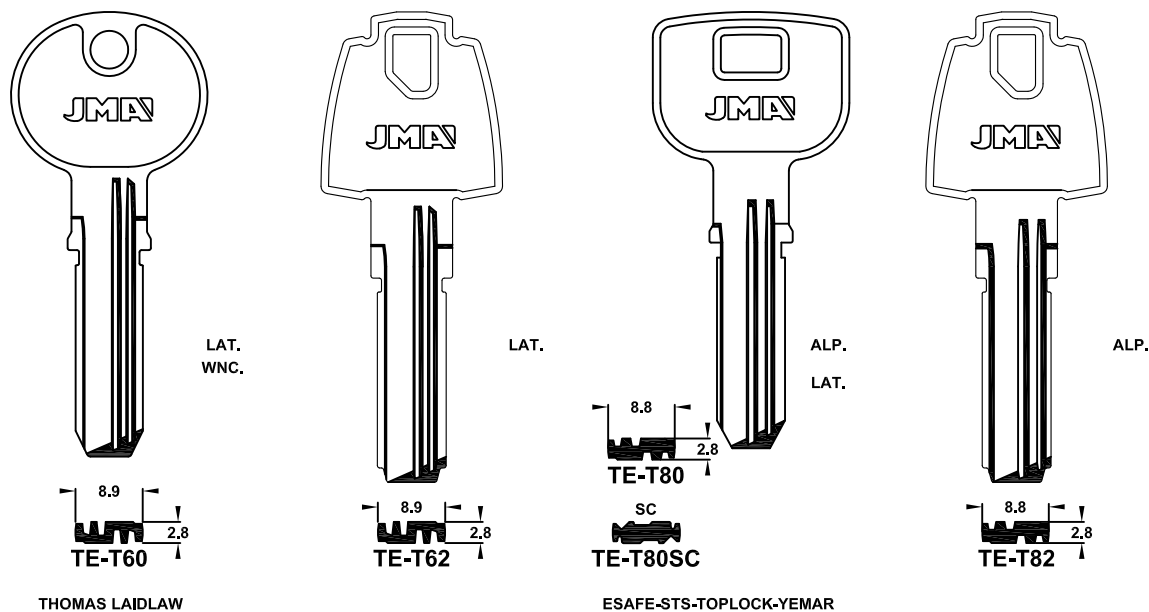





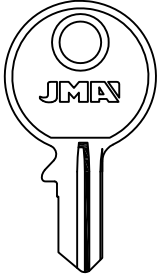
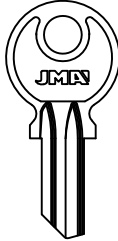
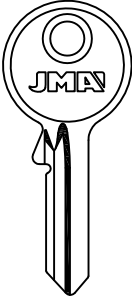
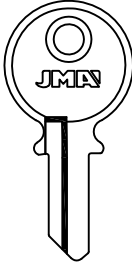





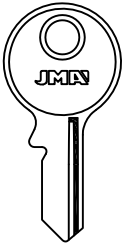
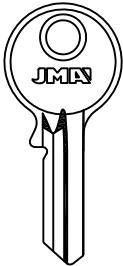
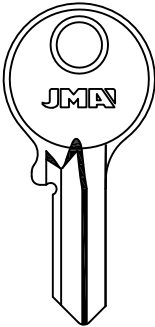
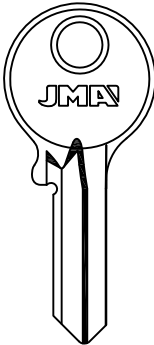

## TESA

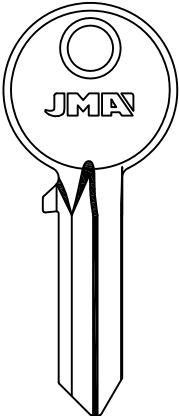
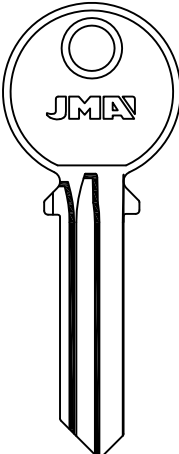
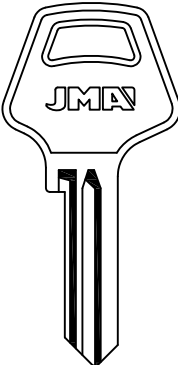
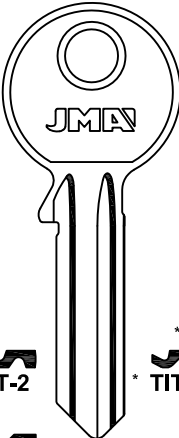

**PARA-FOR:**

- TH (D)
- TICINO (I)
- TIFON (RC)
- TIGRIS (GB)
- TITAN (SLO)

	TH	TICINO	TIFON	
				
	 TH-1 TRUMPH	 TI-1  TI-1D BERTOLOTTI	 TIF-1D	 TIF-2D
	<b>TIFON</b>			
				
	 TIF-15/20	 TIF-25D	 TIF-30D	 TIF-40D
	<b>TIFON</b>	<b>TIGRIS</b>	<b>TITAN</b>	
				
	 TIF-50/60	 TIG-1D	 TIT-1D HILLMANN-PAYKAN	 TIT-2  TIT-10  TIT-2D * ALU.



## TITAN

PARA-FOR:

TITAN (SLO)

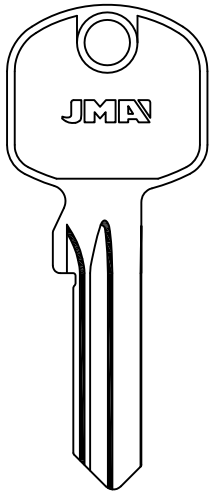

TIT-2GD

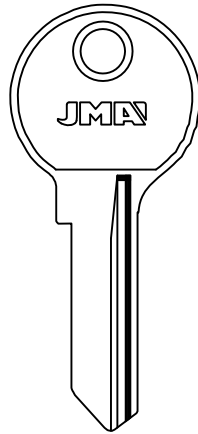

TIT-3

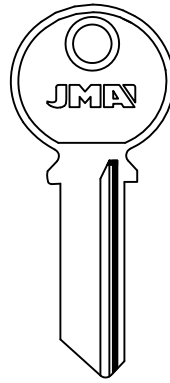

TIT-4

FTH-VACHETTE

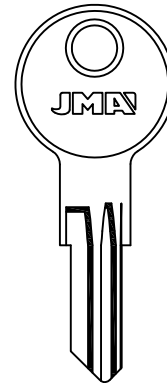

TIT-5

## TITAN

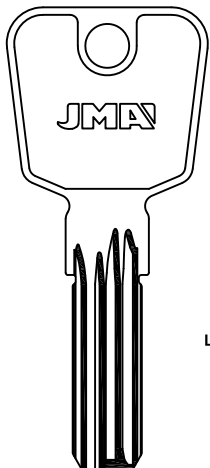

LAT.

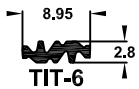

TIT-6

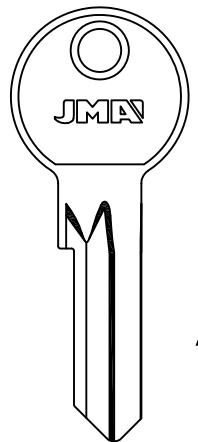

ALU.

TIT-8D

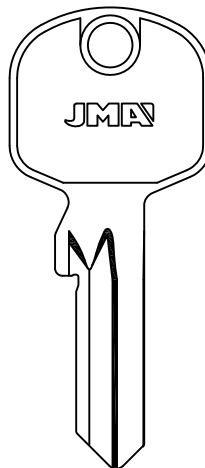

TIT-8GD

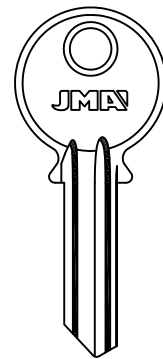

TIT-9

TIT-9D

LAMA

## TITAN

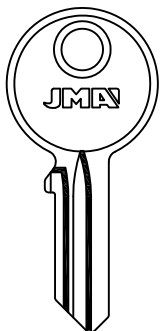

...251-300

TIT-11D



TIT-12D

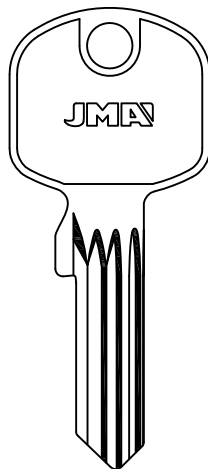

TIT-13

PICARDIE

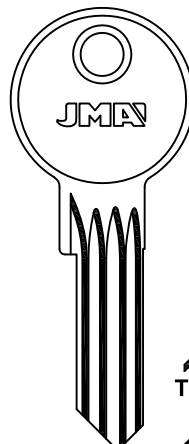

TIT-15

PICARDIE

TIT-18D

TIT-16D

TIT-15D

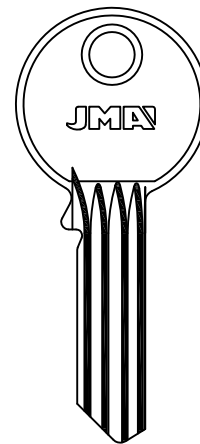

TIT-17



**PARA-FOR:**  
TOK WINKHAUS  
(D)

**TOK WINKHAUS**

TOK-2 TOK-2D TOK-3 TOK-3D TOK-4D TOK-5D

TRELOCK TRELOCK TRELOCK COMBA-SIEBAU TRELOCK-VACHETTE

COL. N/T/9.....  
.....  
0 AL 8

P.....  
0 AL 8

**TOK WINKHAUS**

TOK-6 TOK-6D TOK-27 TOK-26 TOK-25 TOK-32 TOK-33 TOK-23 TOK-28D TOK-15 TOK-16D TOK-13D TOK-14D TOK-11 TOK-12 TOK-9 TOK-10D TOK-34D

N.....  
T.....  
9.....  
.....9  
0 AL 8

EFAFF  
EWSB  
FAABF

EFAM  
EFCP  
FAABF

EHBA  
EKCP  
FAABF

ENAX  
TOK-7D

FICHET-BIFFAR

**TOK WINKHAUS**

TOK-17D TOK-18 TOK-19 TOK-20 TOK-29D TOK-30 TOK-31

TRELOCK



## TOK WINKHAUS

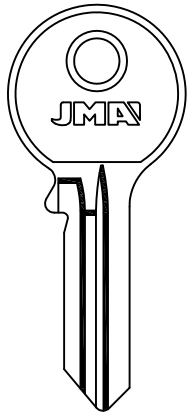

W  
TOK-56D

TRELOCK

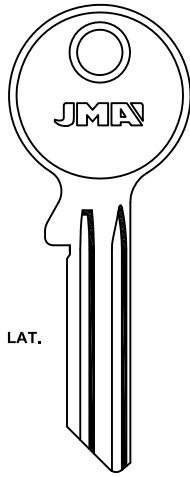

LAT. LAT.



TOK-75



TOK-61



TOK-60



TOK-59



TOK-58



TOK-78



TOK-77

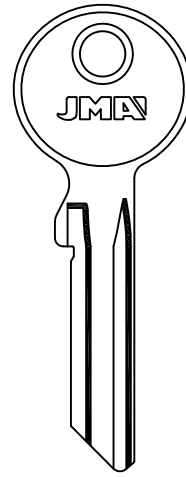

LAT.

TOK-76

SERIE AZ 01 N

PARA-FOR:  
TOK WINKHAUS  
(D)

## TOK WINKHAUS

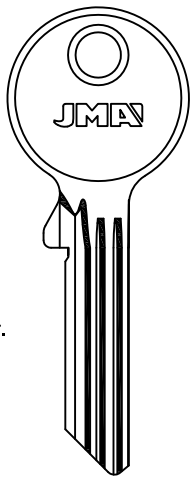

LAT.



X7  
TOK-37



X6  
TOK-62



X5  
TOK-47



X4  
TOK-21



X3  
TOK-46



X2  
TOK-45



X1  
TOK-44



X6  
TOK-62D



X5  
TOK-47D



X4  
TOK-21D



X3  
TOK-46D

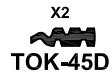

X2  
TOK-45D



X1  
TOK-44D



X14  
TOK-40



X13  
TOK-8



X12  
TOK-39



X11  
TOK-38



X10  
TOK-48



X9  
TOK-67



X8  
TOK-63



X10  
TOK-48D



X18  
TOK-69



X17  
TOK-68



X16  
TOK-41



X15  
TOK-49



X16  
TOK-41D

SERIE X

## TOK WINKHAUS

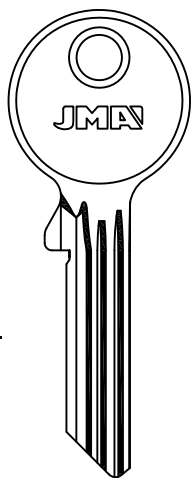

LAT.



Y7  
TOK-52



Y6  
TOK-43



Y5  
TOK-51



Y4  
TOK-70



Y3  
TOK-22



Y2  
TOK-42



Y1  
TOK-50



Y14  
TOK-24



Y13  
TOK-72



Y12  
TOK-66



Y11  
TOK-64



Y10  
TOK-54



Y9  
TOK-53



Y8  
TOK-71

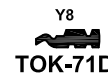

Y8  
TOK-71D



Y18  
TOK-74



Y17  
TOK-65



Y16  
TOK-55



Y15  
TOK-73

SERIE Y

**JMA**<sup>®</sup>

Copyright by Alejandro Altuna S.A. 2014



ATENCIÓN: Concerniente a las marcas y denominaciones comerciales ver nota en índice.  
ATTENTION: Concerning the marks and commercial denominations see note in index.  
ATTENTION: Concernant les marques et dénominations commerciales voir la note dans l'index.  
ACHTUNG: Beziehen auf die marke und handelsname sehen sie die notiz im index.

**PARA-FOR:**





TOMSK (RUS)



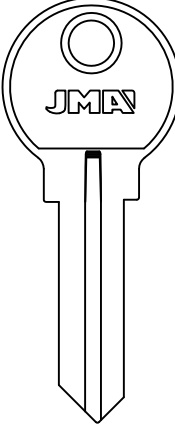
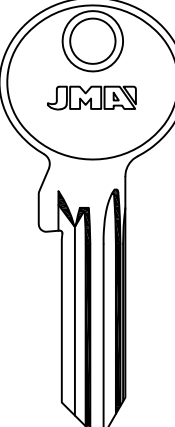
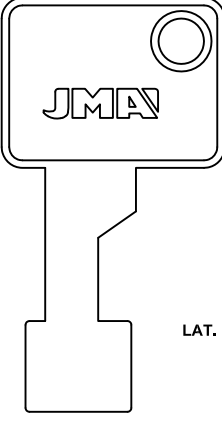
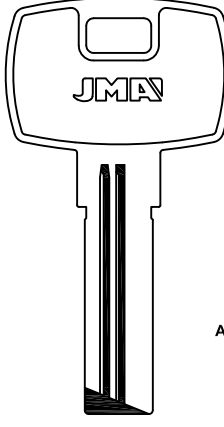

TOP (D)



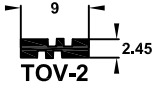

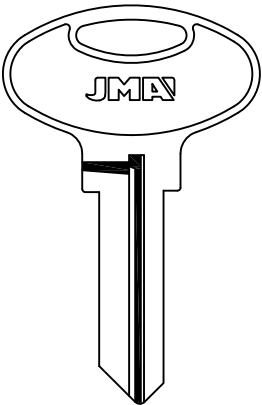
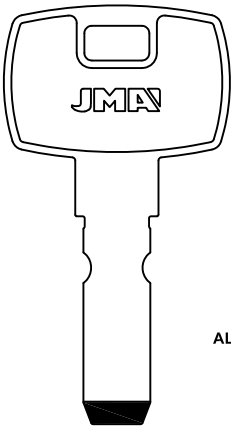
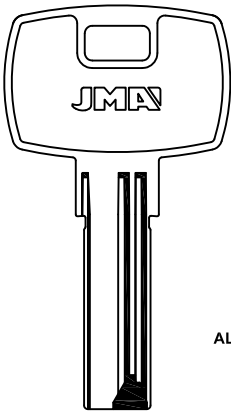
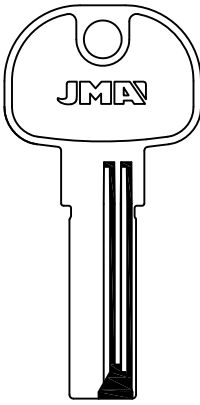
TOVER (E)

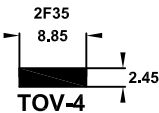
TRAVEX (PE)

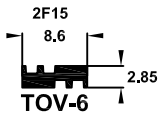
TRELOCK (D)

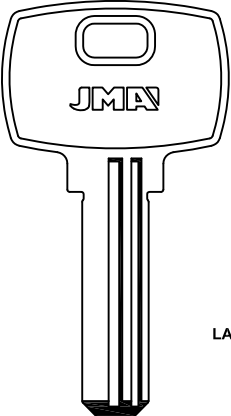
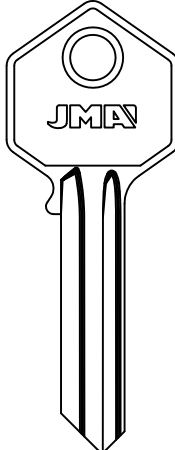
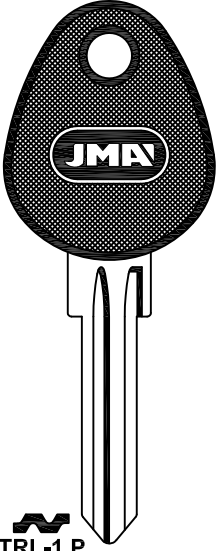
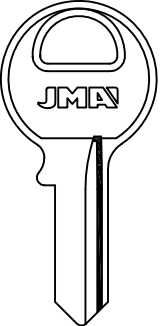
TOMSK	TOP	TOVER	
			
 TOM-1	 TOP-1 ABUS-NOVA	 TOV-1 TEICOCIL	 TOV-2

TOVER			
			
 TOV-3	 TOV-4 TROMER	 TOV-5	 TOV-6

TOVER	TRAVEX	TRELOCK	
			
 TOV-7	 TRV-1	 TRL-1.P	 TRL-2 HAMPTON



## TRI-CIRCLE

PARA-FOR:  
TRI-CIRCLE (RC)

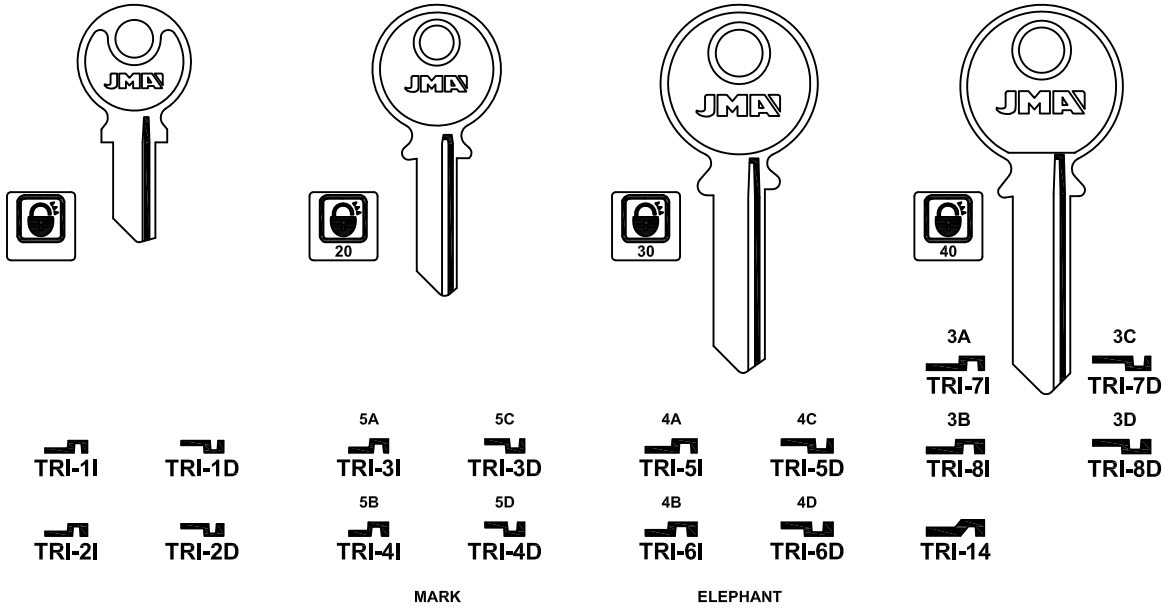

MARK

ELEPHANT

## TRI-CIRCLE

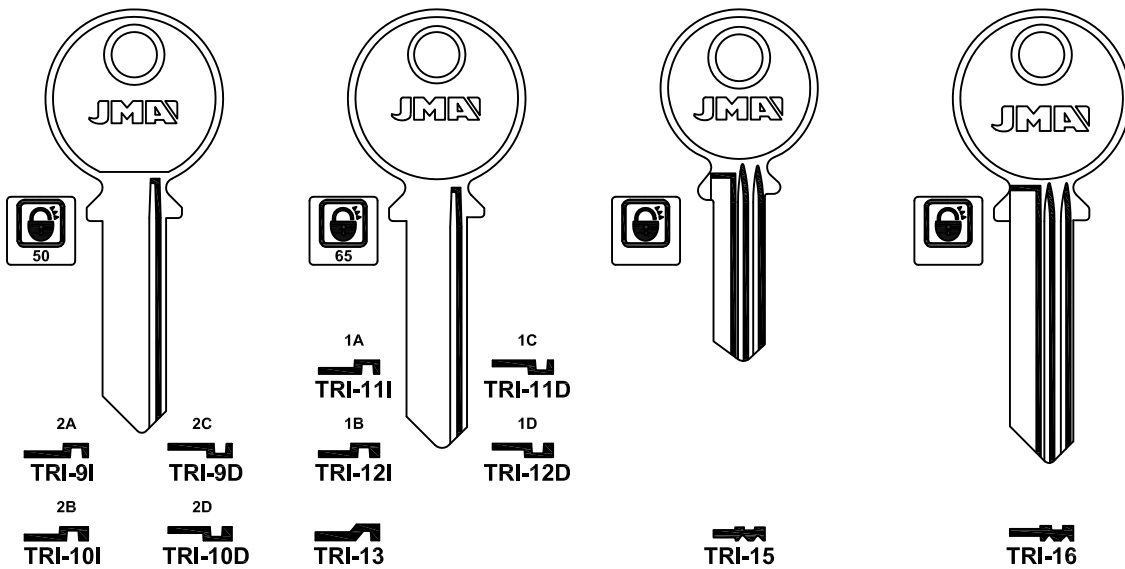

## TRI-CIRCLE

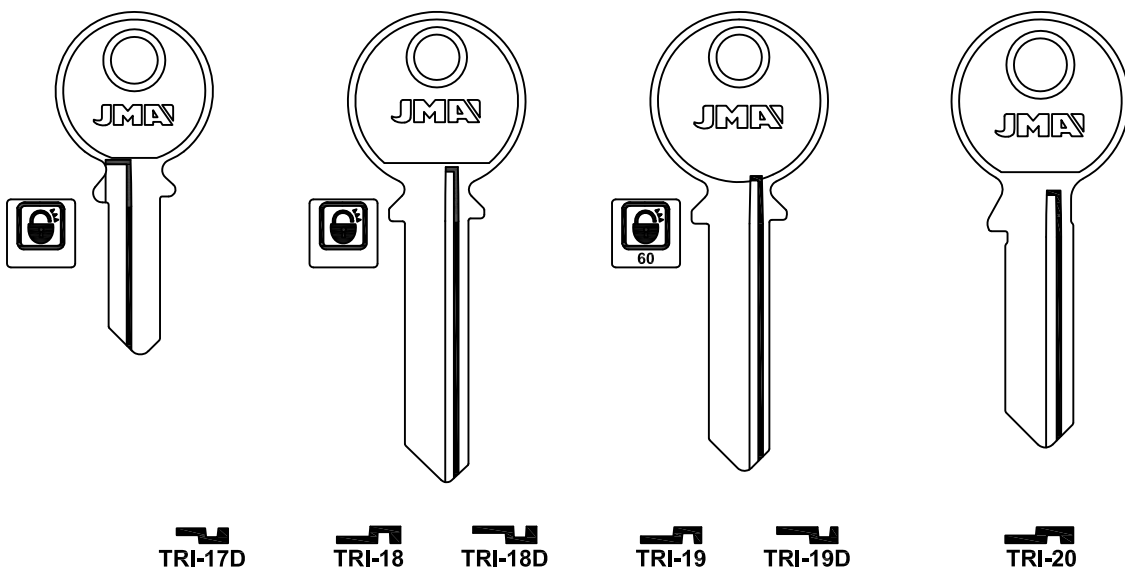

**JMA**®

Copyright by Alejandro Altuna S.A. 2014



ATENCIÓN: Concerniente a las marcas y denominaciones comerciales ver nota en índice.  
ATTENTION: Concerning the marks and commercial denominations see note in index.  
ATTENTION: Concernant les marques et dénominations commerciales voir la note dans l'index.  
ACHTUNG: Beziehen auf die marke und handelsname sehen sie die notiz im index.



**PARA-FOR:**

TRI STAR (RC)







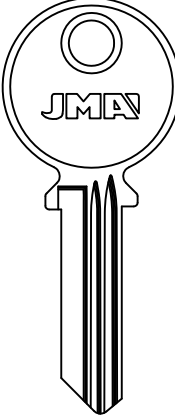
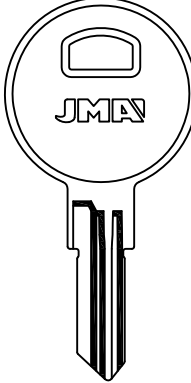
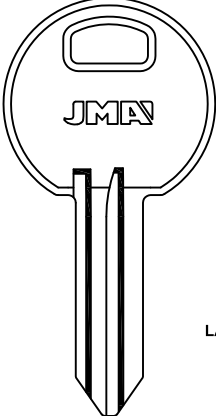
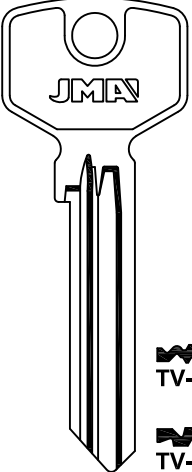

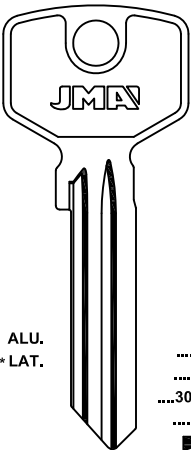
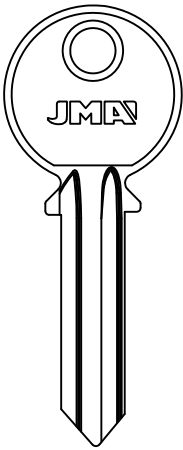
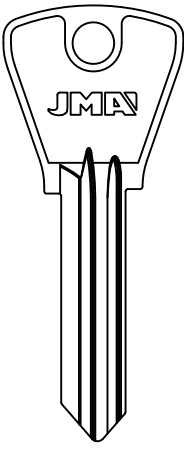
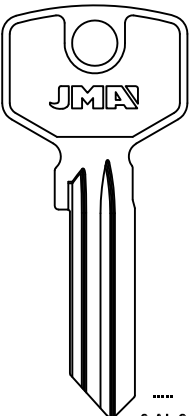

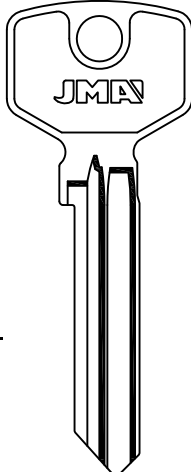

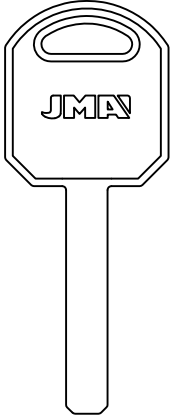

TRIMARK (USA)

TRIO-VING (N)







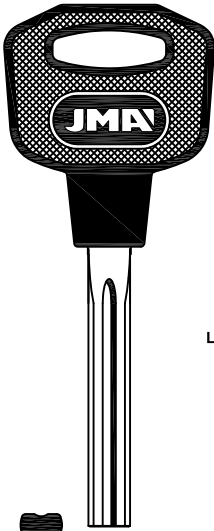

TRUPER (USA)

TRI STAR	TRIMARK		TRIO-VING
			
TST-1	TRM-4	TRM-11D	TV-13

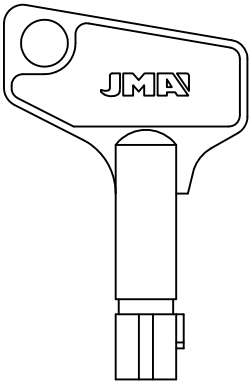

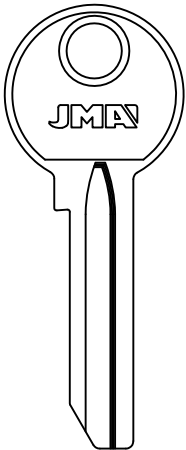

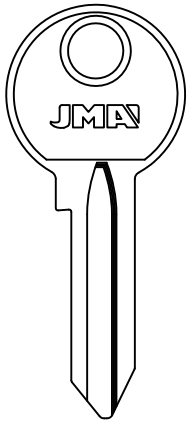



TRIO-VING			
			
ALU. *LAT. .....1 AL 9 .....0 AL 9 ...30000-56769 .....1-26770 *TV-3D	ALU.	ALU.	..... 0 AL 9
TV-4D	TV-11	TV-12	TV-15D TV-16D

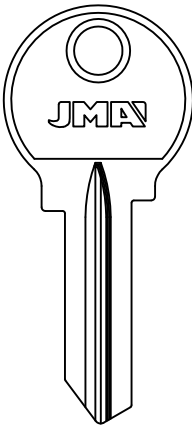

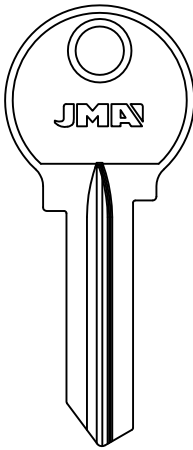

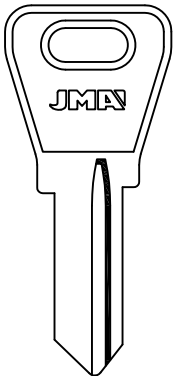

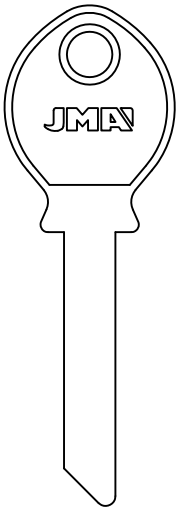

TRIO-VING	TRUPER		
			
*LAT.	*TV-17	*TV-17D	
			
		*TV-18D	
			
		*TV-19D	
			
	*TV-20		
			
	*TV-21	TV-32	
			
	*TV-22	TV-31	
			
	*TV-23	*TV-23D	*TV-30
			
			TRU-7

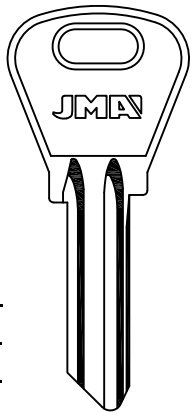

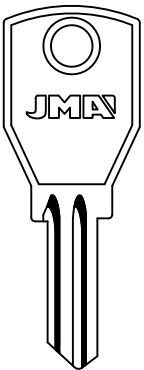
TRUPER	TSAG	TULA	
 <p>LAT.</p>  <p>TRU-8.P</p>	 <p>J</p>  <p>SAG-1T</p>	  <p>TUL-1D</p>	  <p>TUL-2D</p>

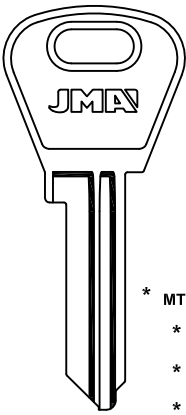
**PARA-FOR:**  
 TRUPER (USA)  
 TSAG (E)  
 TULA (RUS)  
 TUSHINO (RUS)  
 TZAFRER (GR)  
 UCEM (E)

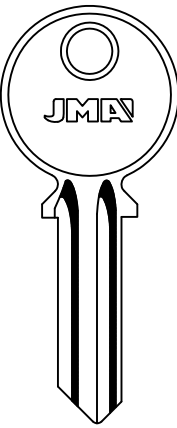
TUSHINO		TZAFRER	UCEM
  <p>TUS-1D</p>	  <p>TUS-2D</p>	  <p>TZ-1</p>  <p>TZ-1D</p>	  <p>5-L</p>

UCEM			
 <p>* ALU. * LAT. * FSH.</p>  <p>* UCEM-11</p>  <p>UCEM-1D</p>	  <p>UCEM-21</p>  <p>UCEM-2D</p>	 <p>* MTIC.(V) * ALU. * LAT. * FSH.</p>  <p>UCEM-3</p>  <p>UCEM-12 *</p>	  <p>UCEM-41</p>
CIB-ENA.OQ-QCM-RIV		CIB-ND	STIQAM



**PARA-FOR:**

UCEM (E)  
 ULIANOVSK (RUS)  
 UMF (P)

**UCEM**

ALP.      ALP.      LAT. WNC.      ALP.

DEBEAURAIN      DEBEAURAIN  
 ESAFE      ESAFE  
 ISEO      ISEO  
 ND      ND  
 YEMAR      YEMAR

UCEM-5I      UCEM-5D      UCEM-7I      UCEM-7D      UCEM-8D      UCEM-8D.P

PENT

**UCEM**

ALP.      LAT.

UCEM-13D      UCEM-17D

PH

**ULIANOVSK**

UL-1      UL-2D

**ULIANOVSK**

UL-3      UL-4

**UMF**

UMF-1



# UNION

PARA-FOR:  
UNION (GB)

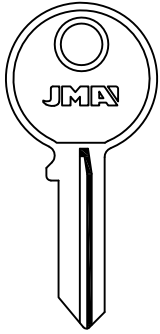

NRA  
FFE...1-100  
FJA...1-100  
FL...251-500  
NRA...51-90  
YFB...1-75  
FMD...1-75  
FG...1-30  
NF...1-30  
EJR...1-75



UN-FFE

UN-3

FP...  
626-750  
UN-FP

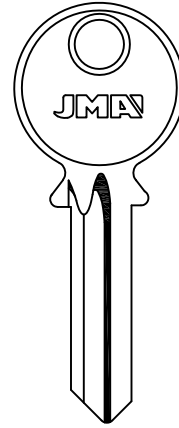
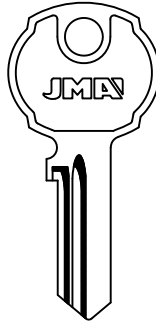

MC...1-40  
MRA...251-290  
MRN...1-54  
MRN...201-250  
MRN...251-300

UN-MRN

HX...100  
UN-2

FR...  
751-875  
UN-FR

FS...1-99  
FS...876-955

UN-1FS

FA...  
501-625

UN-44

RM...  
911-952

UN-44D

NGN...1-54

UN-NG

KB53A  
UN-5D

KB506  
UN-6D

BRITISH LEYLAND-FORD-HILLMAN-JAGUAR-LAND ROVER-MG-MORRIS-ROVER

# UNION

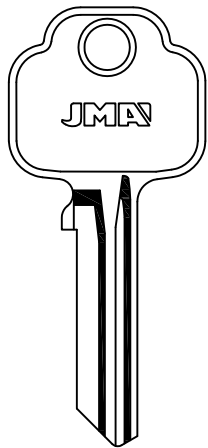

503  
UN-12I  
574  
UN-13I  
575  
UN-14I  
576  
UN-15I  
577  
UN-16I  
578  
UN-17I  
579  
UN-18I

UN-7I

581  
UN-19I  
582  
UN-20I  
583  
UN-21I  
584  
UN-22I  
585  
UN-23I  
586  
UN-24I  
587  
UN-25I  
588  
UN-26I  
589  
UN-27I

914  
UN-13D  
915  
UN-14D  
916  
UN-15D  
917  
UN-16D  
918  
UN-17D  
919  
UN-18D

UN-7D

901  
UN-19D  
902  
UN-20D  
903  
UN-21D  
904  
UN-22D  
905  
UN-23D  
906  
UN-24D  
907  
UN-25D  
908  
UN-26D  
909  
UN-27D

# UNION

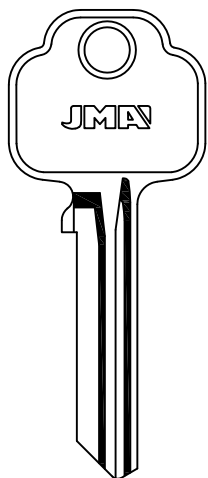

503  
UN-28I  
574  
UN-29I  
575  
UN-30I  
576  
UN-31I  
577  
UN-32I  
578  
UN-33I  
579  
UN-34I

UN-8I

581  
UN-35I  
582  
UN-36I  
583  
UN-37I  
584  
UN-38I  
585  
UN-39I  
586  
UN-40I  
587  
UN-41I  
588  
UN-42I  
589  
UN-43I

914  
UN-29D  
915  
UN-30D  
916  
UN-31D  
917  
UN-32D  
918  
UN-33D  
919  
UN-34D

UN-8D

901  
UN-35D  
902  
UN-36D  
903  
UN-37D  
904  
UN-38D  
905  
UN-39D  
906  
UN-40D  
907  
UN-41D  
908  
UN-42D  
909  
UN-43D

**JMA**®

Copyright by Alejandro Altuna S.A. 2014



ATENCIÓN: Concerniente a las marcas y denominaciones comerciales ver nota en índice.  
ATTENTION: Concerning the marks and commercial denominations see note in index.  
ATTENTION: Concernant les marques et dénominations commerciales voir la note dans l'index.  
ACHTUNG: Beziehen auf die marke und handelsname sehen sie die notiz im index.

**PARA-FOR:**

UNION (GB)

UNIVERSAL

**UNION**

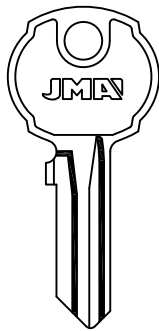

UN-9I

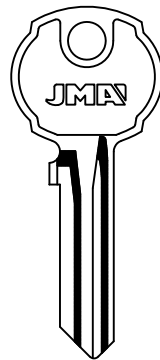

UN-9D

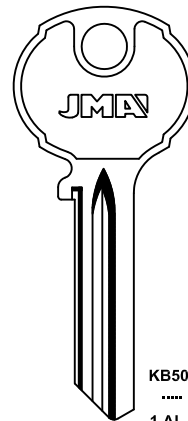

UN-10I



UN-10D

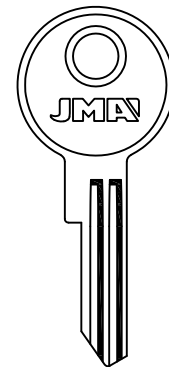

KB502  
.....  
1 AL 6  
UN-11



UN-45D

KB682  
UN-46D

ONIUM

**UNION**

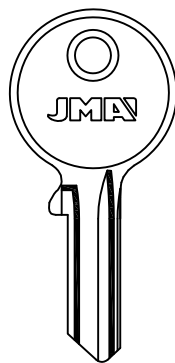

TBS...1-50  
NKL...1-150  
NND...1-150  
TBS...1-500  
TBS...201-350



UN-47

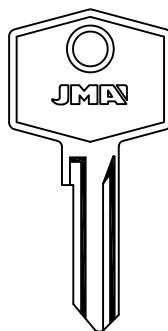

FK...  
01-99  
876-955



UN-FK

JAGUAR-VAUXHALL

FS...  
01-99  
876-955



UN-FS

**UNIVERSAL**

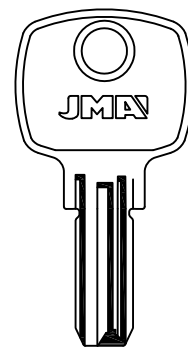

SH2-SH3  
7.2  
2  
TX-1



TX-1

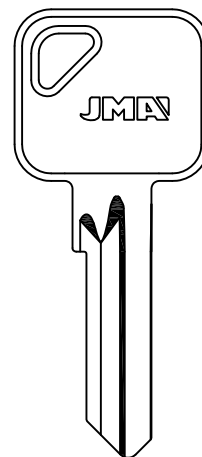

TX-3D

LAT.

EURO SPEC

**UNIVERSAL**

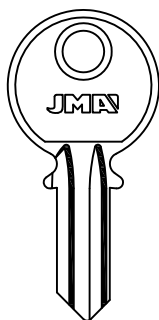

U-1I

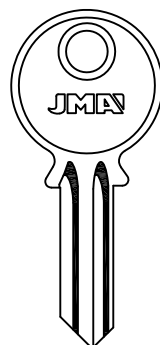

U-1D

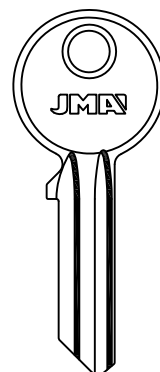

U-2I



U-2D

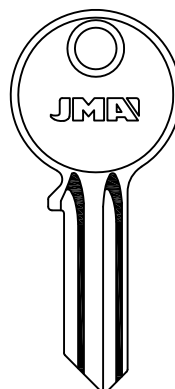

U-3I



U-3D

ALU.



U-4I



U-4D

TECNO



UNIVERSAL

PARA-FOR:  
UNIVERSAL

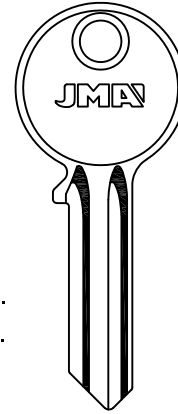
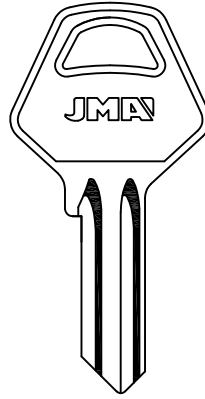
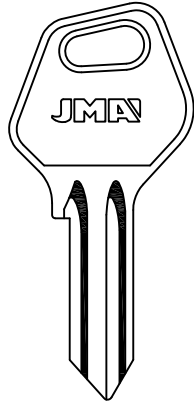
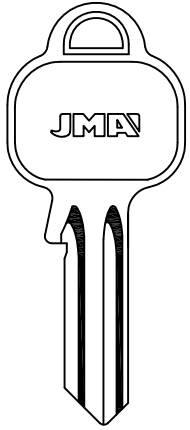

ALU.  
\* FSH.

U-4AI

U-4AD

U-4JI

U-4JD

U-4TI

U-4TD

U-5I

\* U-5D

ESAFE-SIL

UNIVERSAL

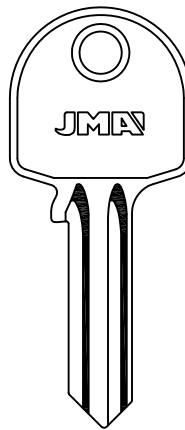
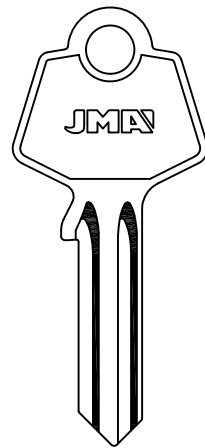
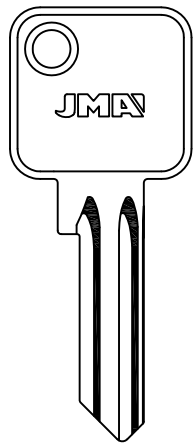
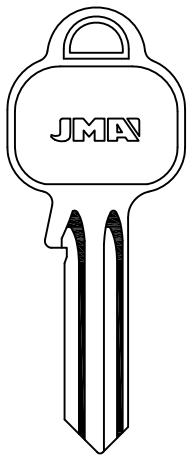

U-5AI

U-5AD

U-5BI

U-5BD

U-5CI

U-5CD

U-5DI

U-5DD

UNIVERSAL

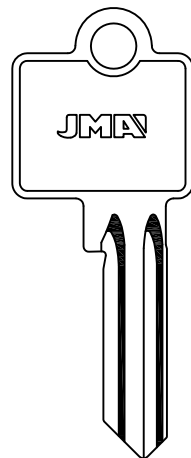
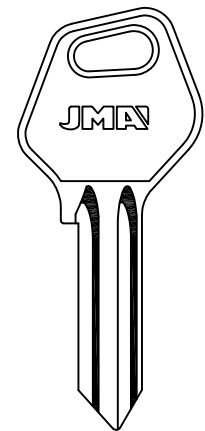
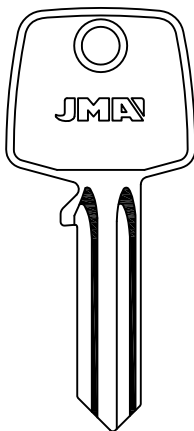
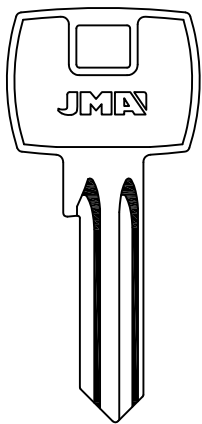

U-5EI

U-5ED

U-5FI

U-5FD

U-5JI

U-5JD

U-5KI

U-5KD



PARA-FOR:  
UNIVERSAL

UNIVERSAL

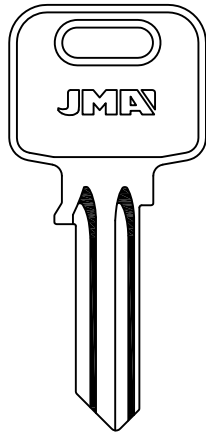

U-5MI

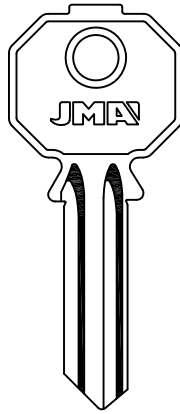

U-5MD

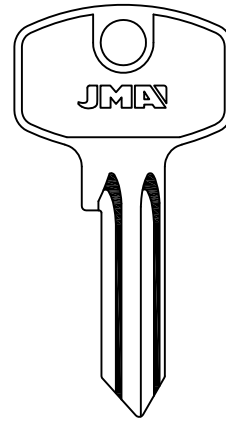

U-5PI

U-5PD

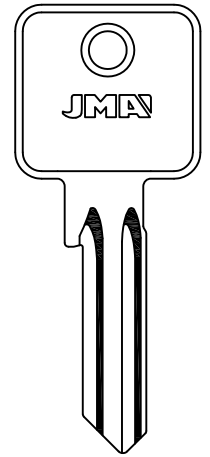

U-5QI

U-5QD

U-5SI

U-5SD

UNIVERSAL

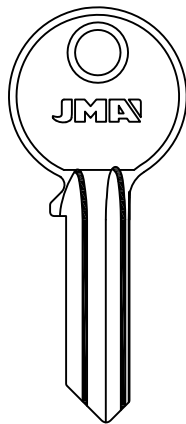

U-5SP

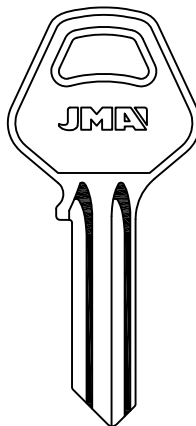

U-5DSP

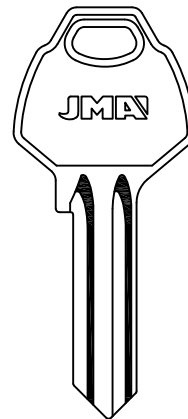

U-5TI

U-5TD

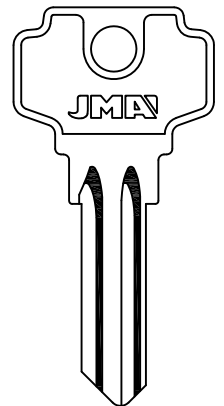

U-5VI

U-5VD

U-5XI

U-5XD

UNIVERSAL

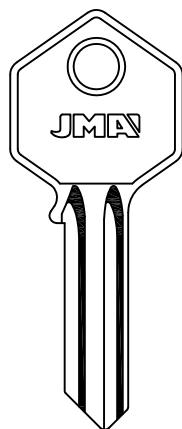

U-5YI

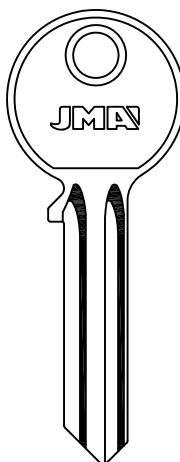

U-5YD

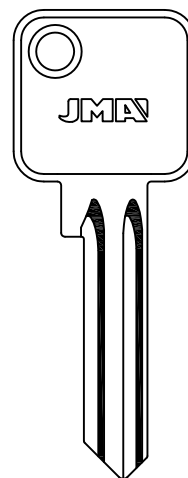

U-6I

U-6D

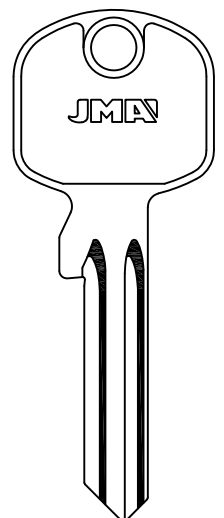

U-6BD

U-6GD

ALU.



UNIVERSAL

PARA-FOR:  
UNIVERSAL

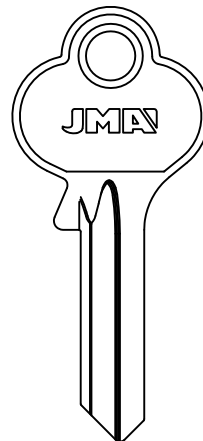
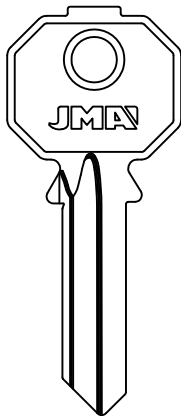
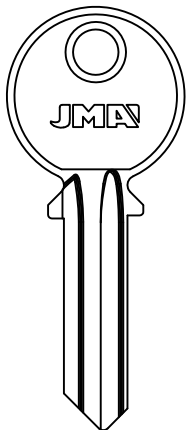
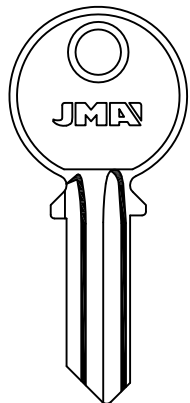

LAT.



TVO-1D

UNIVERSAL

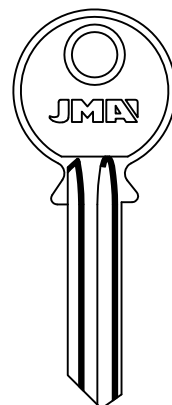
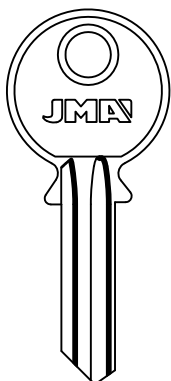
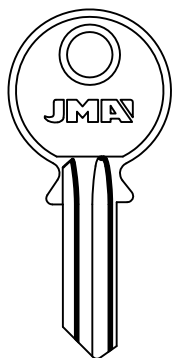
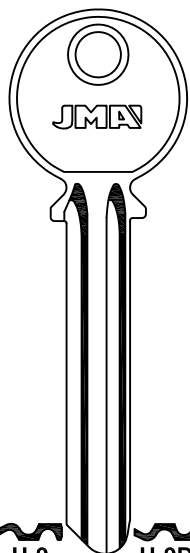

TVO-3D

TVO-2D

UNIVERSAL

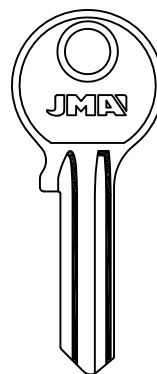
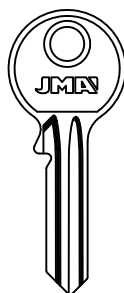
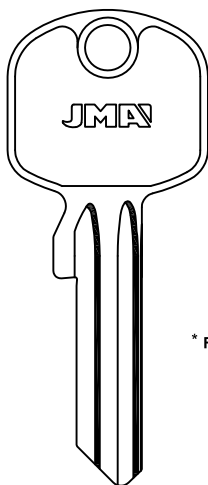
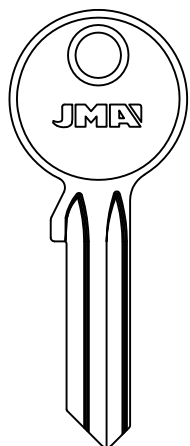

MTIC.

\* FSH.



TVO-4D

CISA LOGO





**PARA-FOR:**

UNIVERSAL

URBIS (R)

URKO (E)

**UNIVERSAL**

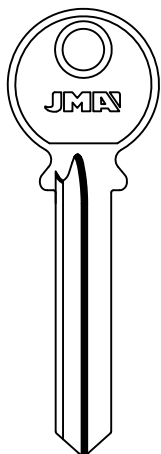

 U-18D

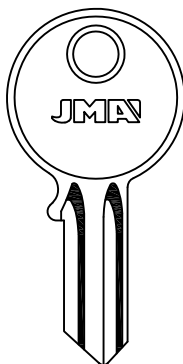

 U-19

LAT.

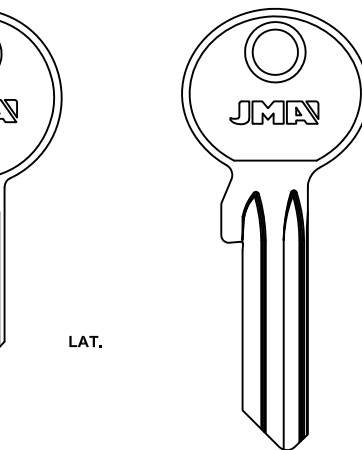

 U-19D

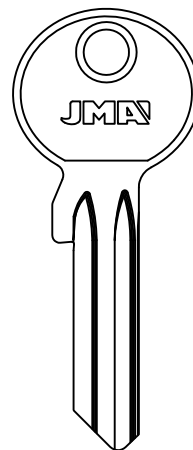

 U-21

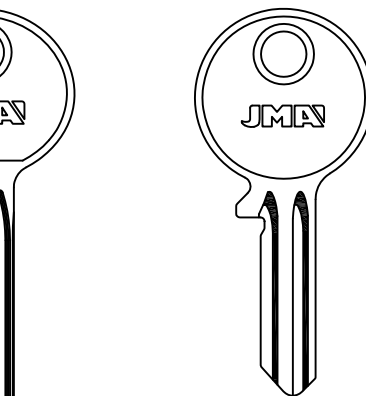

 U-21D

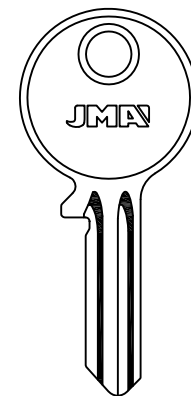

 U-22

 U-22D

**UNIVERSAL**

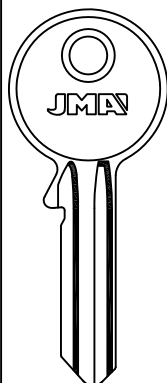

 U-25

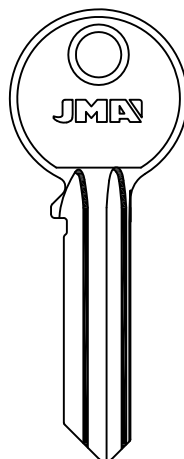

 U-25D

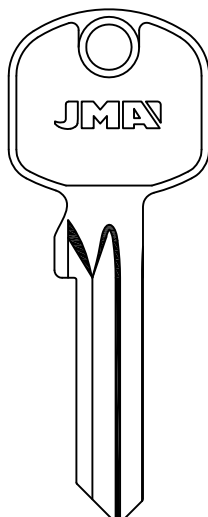

 U-26

 U-26D

 U-26GD

**URBIS**

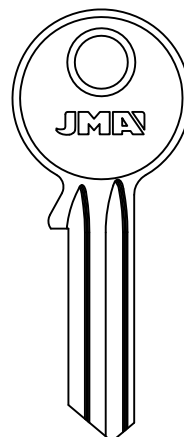

 URB-1

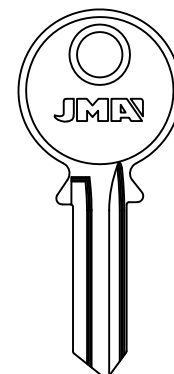

 URB-2

**URBIS**

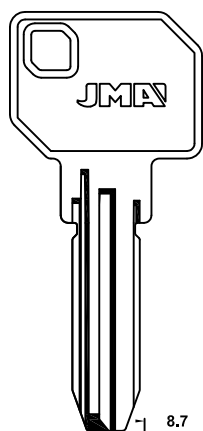

LAT.

 URB-3D

 URB-4D

BANE SEKULIC

**URKO**

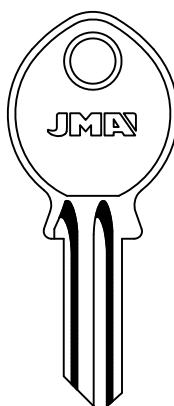

 URKO-11

 URKO-1D

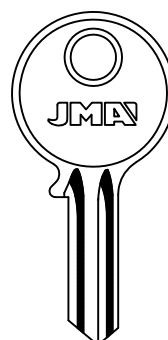

 URKO-21

 URKO-2D

 URKO-31

 URKO-3D

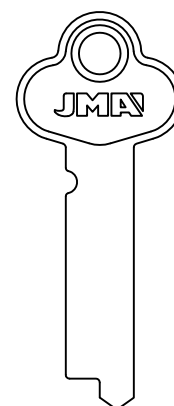

 URKO-4



# VACHETTE

PARA-FOR:  
VACHETTE (F)

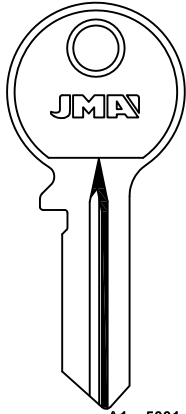

A1...5001-5631



VA-1



VA-75D

BAU-FONTAINE-HEMA-LAPERCHE  
METALUX-MODERN-STREMLER



A...5000-5635

AY...0-249

Y...0-249

AS...0-099

S...0-099



VA-2



VA-5

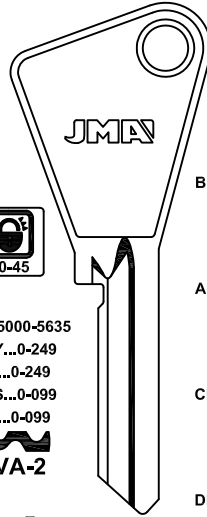

BM...870-894



VA-19

AM...870-894



VA-20

CM...870-894



VA-21

DM...870-894



VA-22

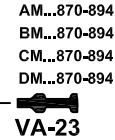

VA-23

AM...870-894

BM...870-894

CM...870-894

DM...870-894

# VACHETTE

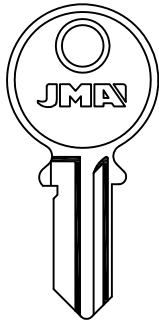

...1 AL 9 AL 0

E...9001-9100

...R9001-9100



VA-3I



VA-3

ISEO-KLIT

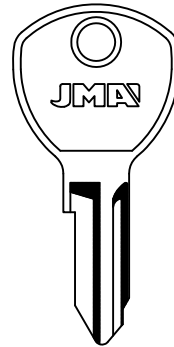

R...0-423



VA-4

V...0-423



VA-13I

G...0-423

D...0-321



VA-4D

W...0-423



VA-13D

ATAL-VINCO

# VACHETTE

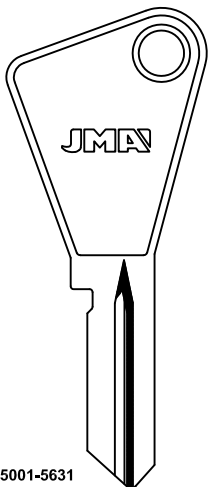

A1...5001-5631

UL...1-3500

U...1 AL 9 AL 0



VA-8D

RA-KA



VA-RA

RB-KB



VA-RB

RC-KC



VA-RC

RE-KE



VA-RE

RF-RK



VA-RF

RG-KG



VA-RG

RJ-KJ



VA-RJ

RK-KK



VA-ROK

RL-KL



VA-RL

RD



VA-RD

RDH



VA-RDH

RDM



VA-RDM

RHM



VA-RHM

RH



VA-RH

RM



VA-RM

RN



VA-RN

RK



VA-RK

LD



VA-LD

LN



VA-LN

LH



VA-LH

LA-AK



VA-LA

LA-BK



VA-LB

LC-CK



VA-LC

LE-EK



VA-LE

LF-FK



VA-LF

LG-GK



VA-LG



**PARA-FOR:**  
VACHETTE (F)

**VACHETTE**

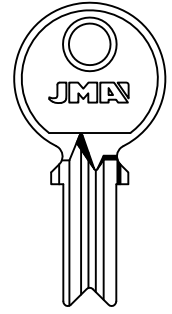
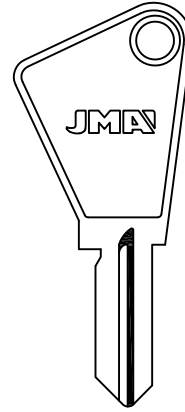
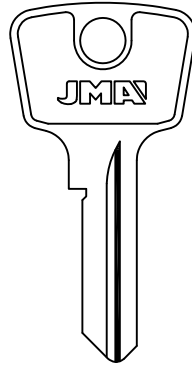
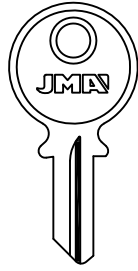

VA-9D

RUKA



VA-12D

TRELOCK

EE...9001-9100

VA-14D

VA-15

**VACHETTE**

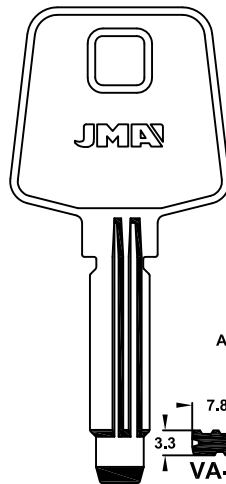
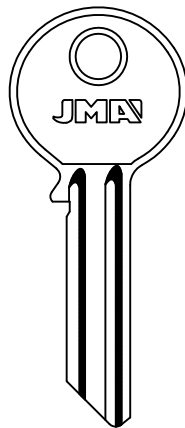

ALP.

VA-25

VA-24I

VA-24D

VA-26

RADIAL

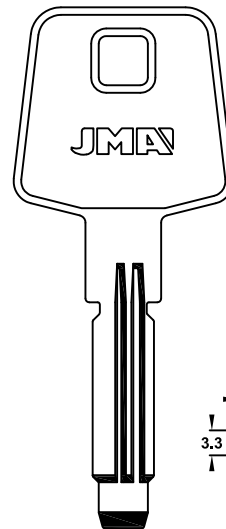

VA-27

VA-28

RADIAL

VA-56

ALP.

**VACHETTE**

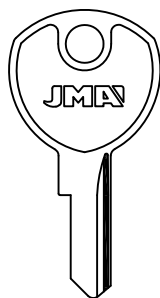

VL...A0-H9

VA-29

RL...A0-H9

VA-35

DAD-JU

WL...A0-H9

VA-29D

K...A0-H9

BL...A0-H9

VA-35D

VA-62

VA-30

VINCO

VA-62D

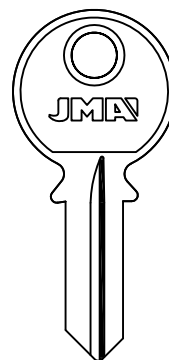

40-50-60

.....

1 AL 8

VA-31D

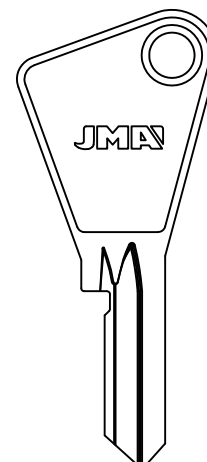

AY...0-249

Y...0-249

VA-32D

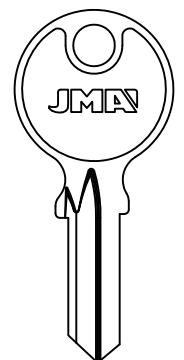

VA-33D



# VACHETTE

PARA-FOR:  
VACHETTE (F)

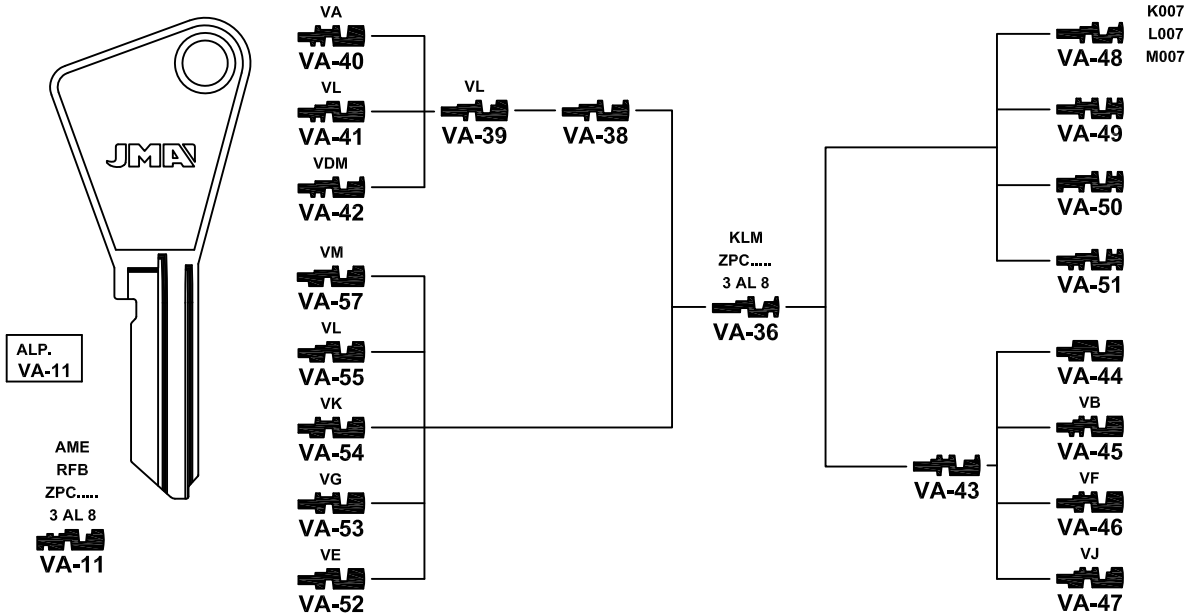

# VACHETTE

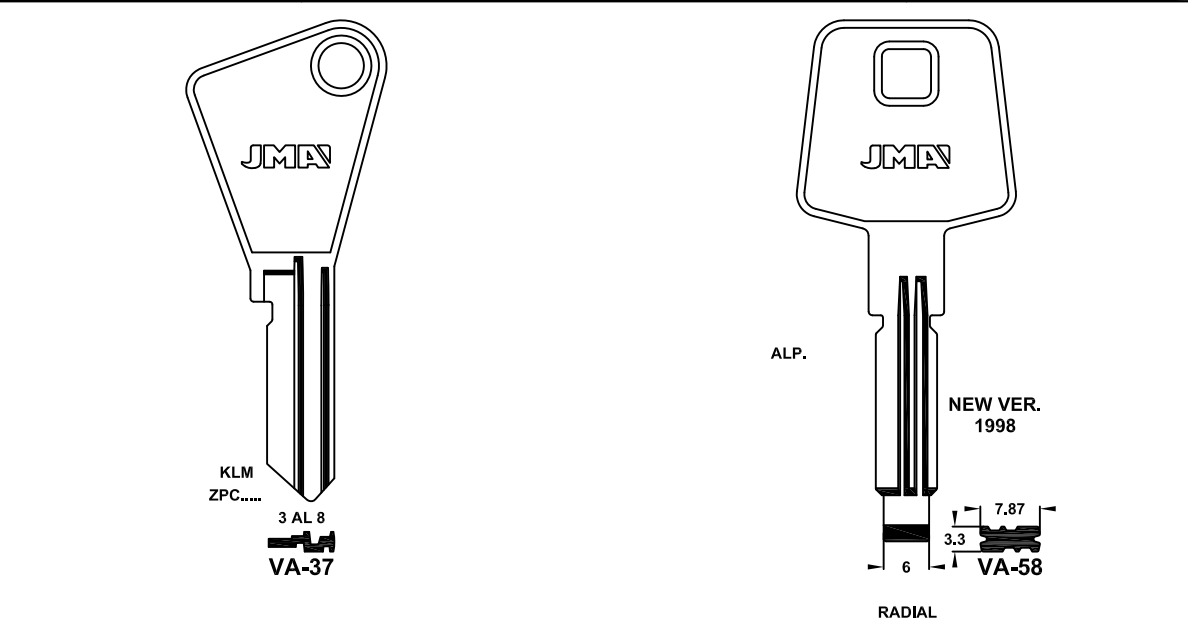

# VACHETTE

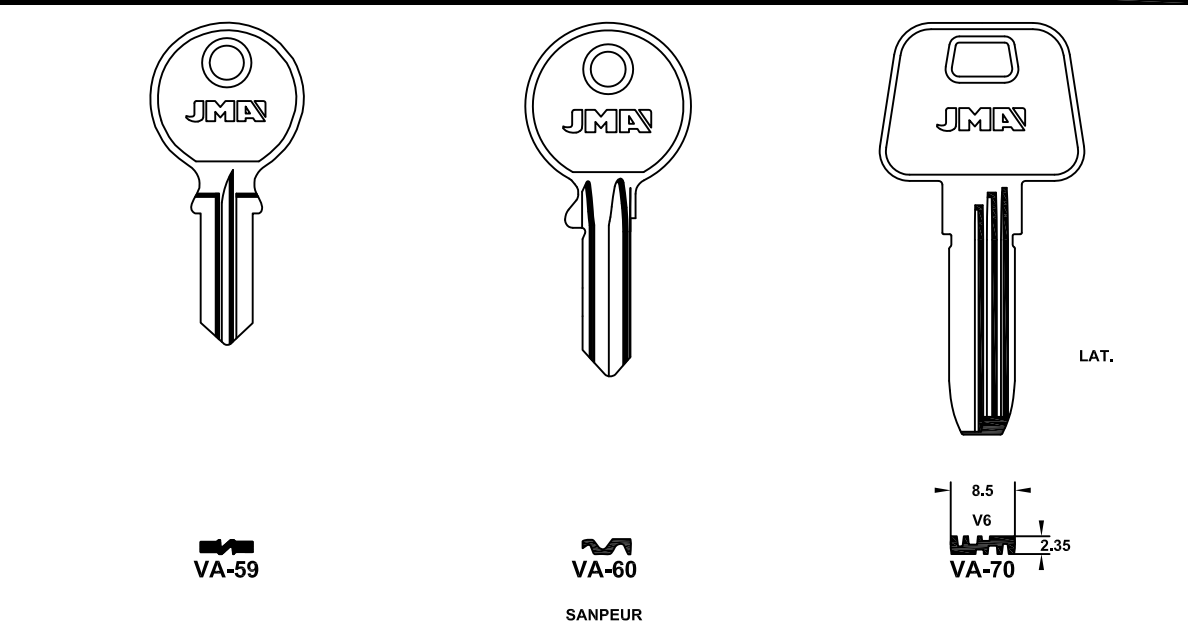

**PARA-FOR:**

- VARIOS
- VBH (D)
- VEGA (F)
- VENDI (RO)

**VARIOS**

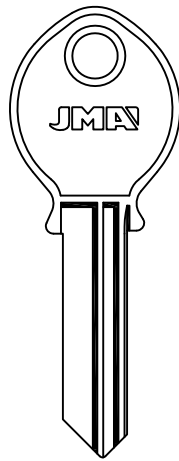

6-C

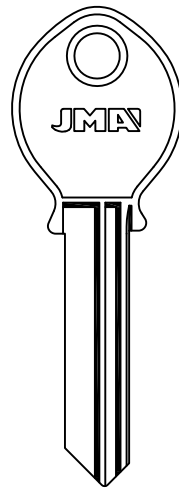

6-L

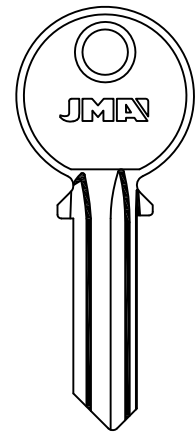

35-I



35-D



38-I



38-D

FAC

**VARIOS**

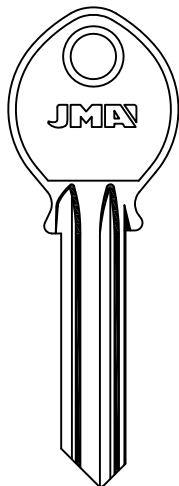

JMA-1I



JMA-1D

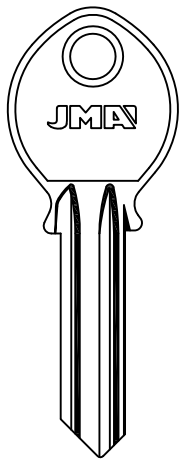

JMA-2I



JMA-2D

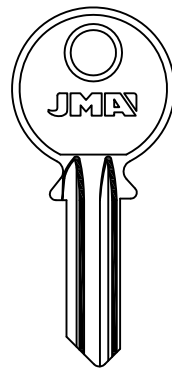

JMA-3I



JMA-3D

RONEO-JCEM



JMA-4I



JMA-4D

BOMORO

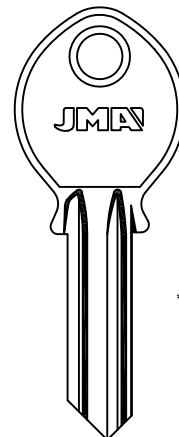

JMA-9I



JMA-9D

\* LAT.  
ALU.

**VBH**

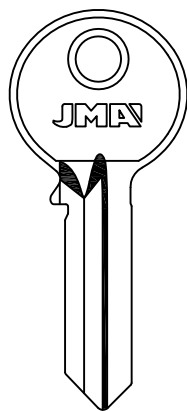

VB-1D

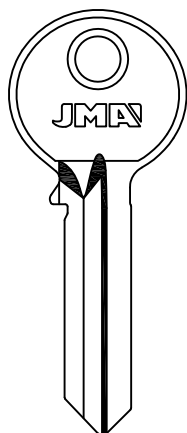

VB-2D

**VEGA**

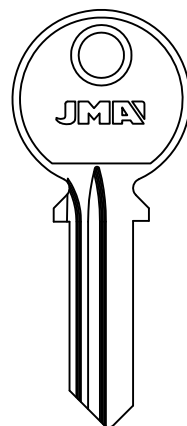

VE-1D

VACHETTE

**VENDI**

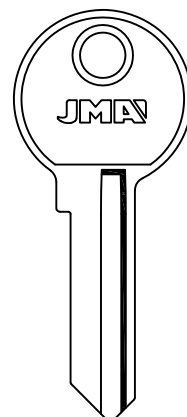

VND-1



VND-1D



VND-2



VND-2D



VENDI	VGF VILLATORE		VING

**PARA-FOR:**  
 VENDI (RO)  
 VGF VILLATORE (I)  
 VING (N)  
 VIRO (I)

VIRO			
** ALU. * LAT.		** ALU. * LAT.	
..... 0 AL 6	..... 0 AL 6	.....0 AL 5	.....012345
** VI-1I	* VI-12	** VI-2I	* VI-15
ABUS-BERAM-ROYAL-TESA		ABT	

VIRO			
.....0 AL 5		..... 20	..... 0 AL 7
ABUS-ROYAL	ABT	ABUS-BURG	SPECIAL



**PARA-FOR:**

- VIRO (I)
- VOLGOGRAD (RUS)
- VOLKOVYSK (RUS)
- WALLY (RC)
- WALRUS (RC)

**VIRO**

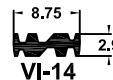
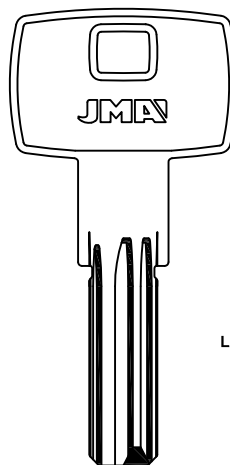
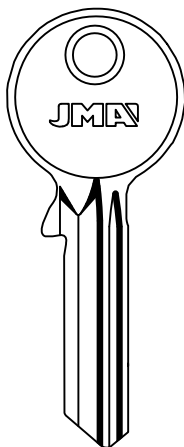
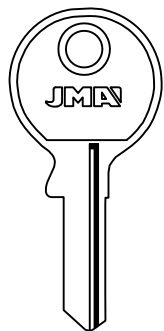

EURO-PRO

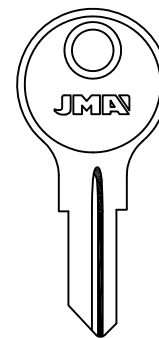

FAI

**VOLGOGRAD**

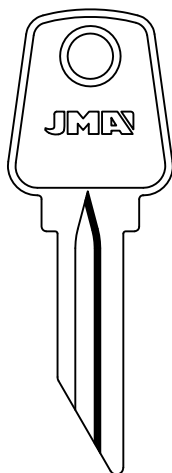

**VOLKOVYSK**

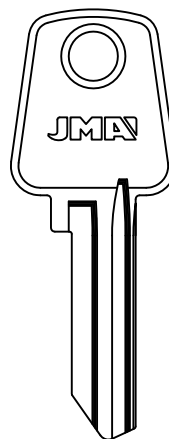
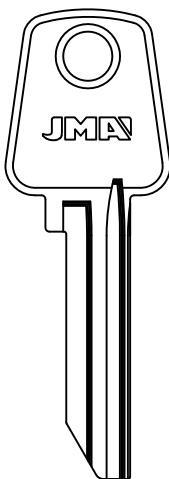

**WALLY**

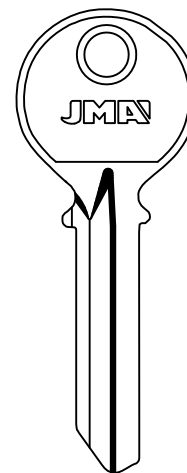

**WALLY**

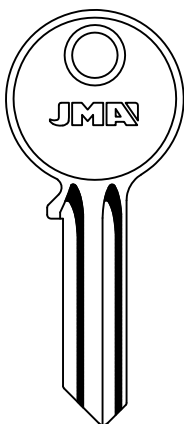
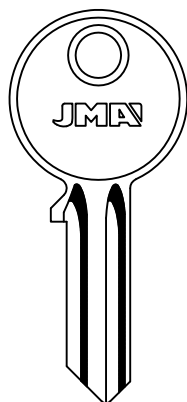



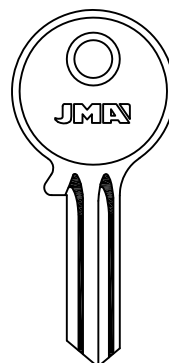



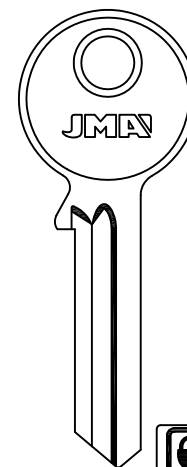

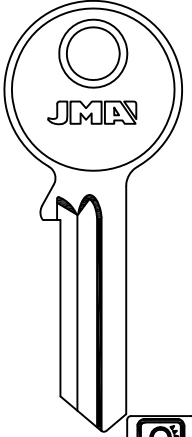

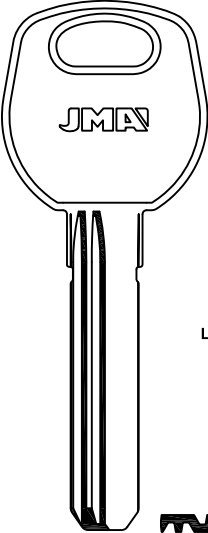
MOREAUX

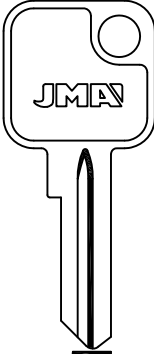



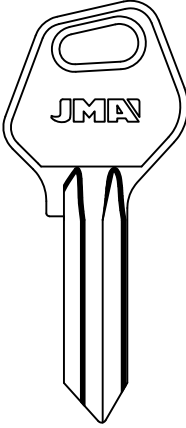





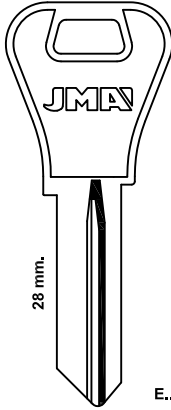

**WALRUS**

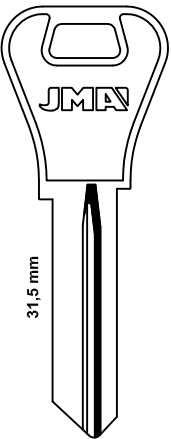

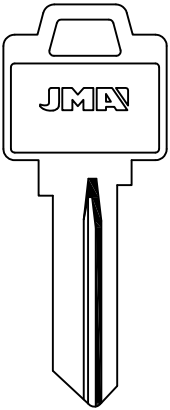

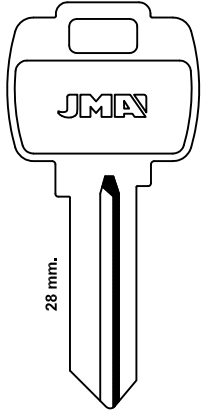

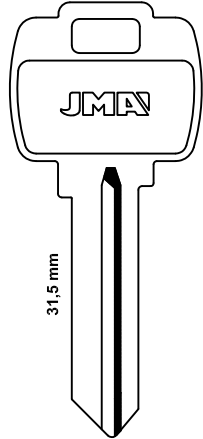





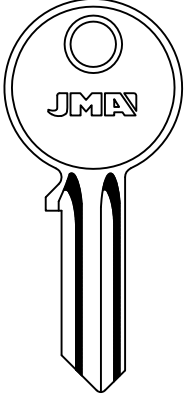

WALRUS	WANJIN	WEBER	WEBSTER
 <p>JMA</p>  <p>WAL-2D</p>	 <p>JMA</p> <p>LAT.</p>  <p>WAN-1D</p>	 <p>JMA</p>  <p>WEB-1</p>  <p>WEB-2</p>  <p>WEB-3</p> <p>WECO</p>	 <p>JMA</p>  <p>WBS-1</p>

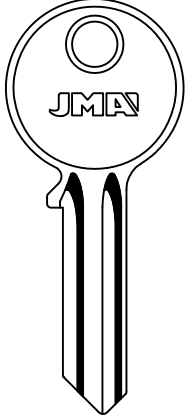
**PARA-FOR:**  
 WALRUS (RC)  
 WANJIN (PRC)  
 WEBER (D)  
 WEBSTER (GB)  
 WEISER (USA)  
 WELKA (I)  
 WESLOCK (USA)

**WEISER**

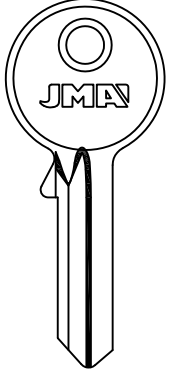
 <p>JMA</p> <p>28 mm.</p>  <p>WEI-1</p>  <p>WEI-6</p> <p>KAWE</p>	 <p>JMA</p> <p>31,5 mm</p>  <p>WEI-2</p> <p>FALCON-FICHET</p>	 <p>JMA</p>  <p>WEI-3</p> <p>IDEAL SECURITY</p>	 <p>JMA</p> <p>28 mm.</p>  <p>WEI-4</p> <p>FALCON</p>	 <p>JMA</p> <p>31,5 mm</p>  <p>WEI-5</p> <p>FALCON</p>
--	--	--	---	---

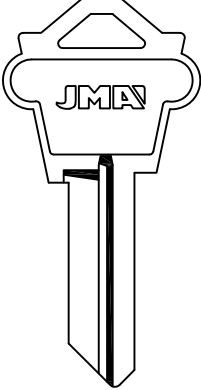
**WELKA**      **WESLOCK**

 <p>JMA</p>  <p>WE-4I</p>	 <p>JMA</p>  <p>WE-4D</p>	 <p>JMA</p>  <p>WE-5I</p>	 <p>JMA</p>  <p>WE-5D</p>	 <p>JMA</p>  <p>WE-6D</p>	 <p>JMA</p>  <p>WES-1D</p>
--	---	---	---	---	--





**PARA-FOR:**

WESTLOCK (USA)

WHITCO (AUS)

WILKA (D)

WEST LOCK		WHITCO	WILKA
V.... 1 AL 6  WST-1D	V.... 1 AL 6  WST-2D	.....0123456789A  WHI-1D	..... 1 AL 9  WIL-1D
		LAT.	ALU.
			WIL-7 JORE-WIGRO

**WILKA**

 WIL-2D	 WIL-3D	..... 1 AL 9  WIL-4D	.....  WIL-5	1 AL 9  WIL-5D
	CFP-GBS	JORE-WIGRO		
		MTIC.		

**WILKA**

 * LAT.	* WIL-26	* WIL-33D	* WIL-40D	* WIL-48D	* WIL-55	* WIL-62	
	* WIL-25	* WIL-32	* WIL-39D	* WIL-47D	* WIL-54	* WIL-61	
	W101 WIL-24	* WIL-31D	* WIL-38D	* WIL-46D	* WIL-53	* WIL-60D	
	WIL-19D	* WIL-30	* WIL-37D	* WIL-45D	* WIL-52	* WIL-59D	
	WIL-18	* WIL-29	* WIL-36D	* WIL-44	WIL-51D	* WIL-58D	
	* WIL-9	* WIL-28	* WIL-35D	* WIL-43D	* WIL-50D	* WIL-57D	WIL-65D
	WIL-8	* WIL-27	* WIL-34D	* WIL-41D	* WIL-49D	* WIL-56	* WIL-63D



## WILKA

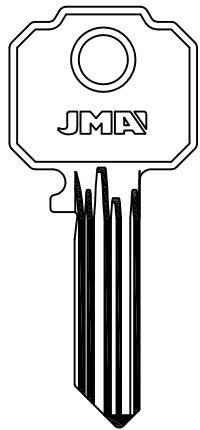

  
WIL-14

  
WIL-15

  
WIL-12

  
WIL-13

  
WIL-10

  
WIL-11

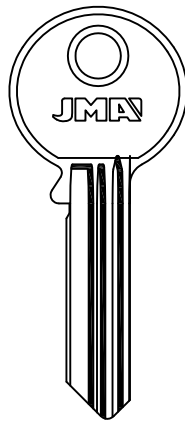

  
WIL-16

  
WIL-17D

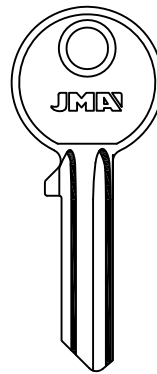

  
WIL-20

## PARA-FOR:

- WILKA (D)
- WINDHAUS (D)
- WINLOCK (GB)
- WIREROPE (HK)

## WILKA

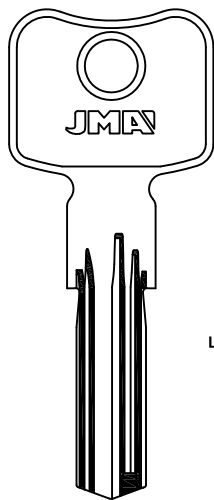

  
WIL-22

SERIE 3600

LAT.

LAT.

  
WIN-11

ALP.

  
WIN-1D

  
WIN-2D

  
WIN-3D

AZBE

## WINKHAUS

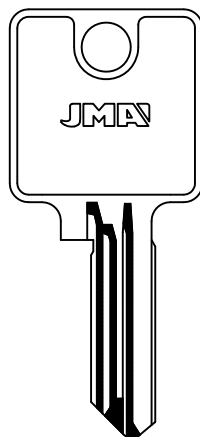
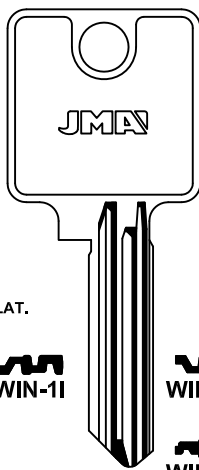

ALP.

  
WIN-4D

AZBE

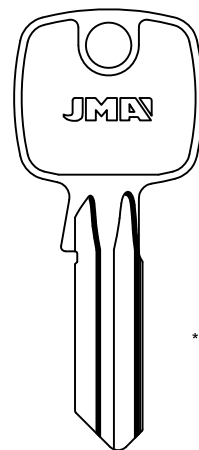

\* ALP.  
ACE.

  
\* WIN-5

  
WIN-5D

## WINKHAUS

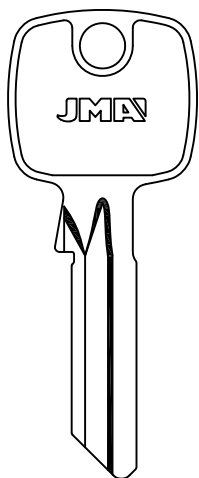

  
WIN-6D

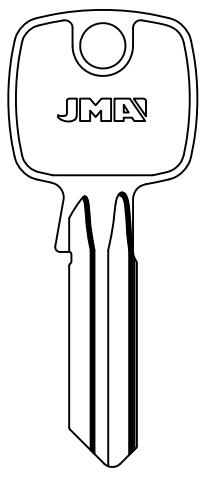

  
WIN-21

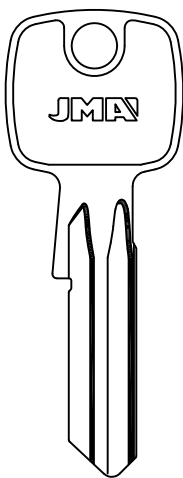

  
WIN-22

## WINLOCK

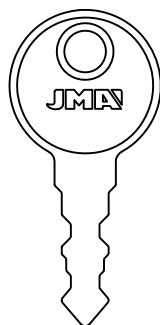

  
WNC-1

## WIREROPE

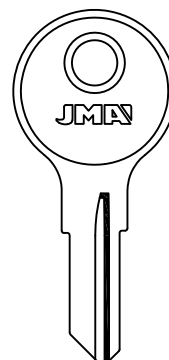

  
WIR-1



**PARA-FOR:**

WMS (GB)  
 WT (TJ)  
 YALE  
 (D-GB-USA)

**WMS**

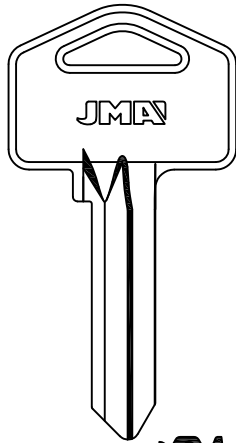

WM-1D

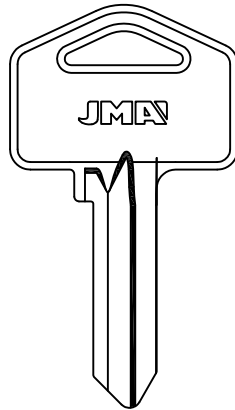

WM-2D

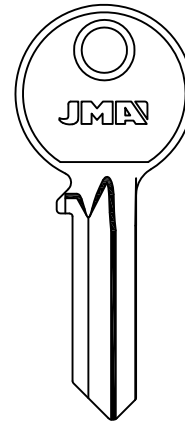

WM-3D

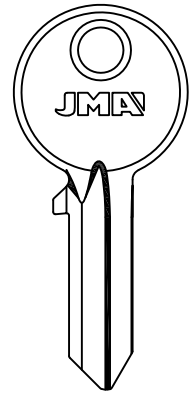

WM-4D

WM-5D

I.R.-TITUS

**WT**

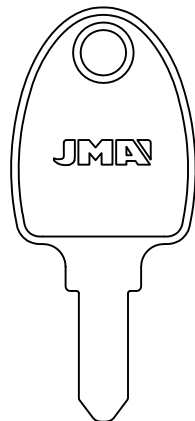

WT-1

LAT.

**YALE**

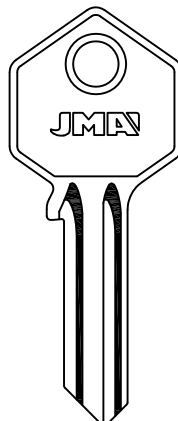

YA-1I YA-1D  
 ....0 AL 9

WALE

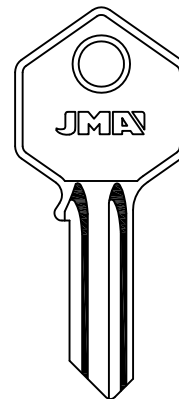

YA-2I YA-2D  
 ....0 AL 9

WALE

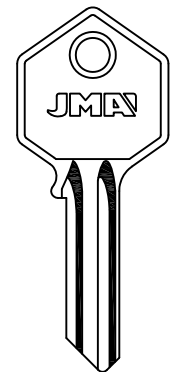

YA-3I YA-3D  
 ....0 AL 9

WALE

**YALE**

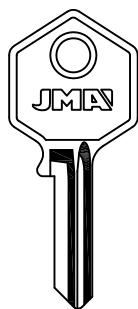

YA-5I YA-5D

MIGNON

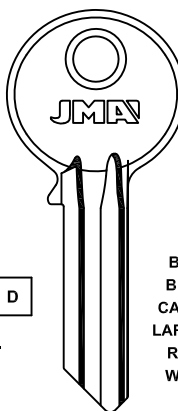

D  
 ALU.

YA-6I YA-6D  
 ....0 AL 9

BKS  
 BIRD  
 CARAT  
 LAREDO  
 ROC  
 WOC

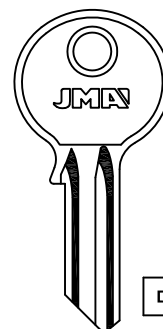

YA-7I YA-7D

BKS-WECO

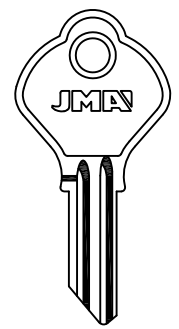

YA-8I YA-8D  
 DC...551-952

R..101-150  
 SX...1-1000  
 VR...1-4000  
 BX...1-500  
 YA-16D

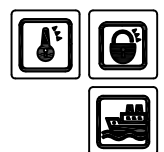

# YALE

PARA-FOR:

YALE  
(D-GB-USA)

Key 1: JMA logo, GB code, profiles YA-10, YA-10D, LT...1-100, LC...1-100.  
 Key 2: JMA logo, USA GB codes, ALU. material, ABUS, BENDIX, CAB, CHICAGO, COLE HERSEE brands, profiles YA-11I, YA-11D.  
 Key 3: JMA logo, D GB codes, ABG... 7537-8336, profiles YA-12I, YA-12D, YA-13I, YA-13D.

BKS

# YALE

Key 1: JMA logo, D GB codes, profiles YA-17I, YA-17D, YA-26I, YA-29, YA-14I, YA-14D, YA-39, YA-39D.  
 Key 2: JMA logo, D GB codes, profiles YA-15I, YA-15D.  
 Key 3: JMA logo, ALU. material, profiles YA-22I, YA-22D, .....0 AL 9.

# YALE

Key 1: JMA logo, ALP. material, profile YA-23.  
 Key 2: JMA logo, ALU. material, \* FSH. material, GB code, profiles YA-24I, YA-24D, .....0 AL 9.  
 Key 3: JMA logo, D GB codes, profile YA-25I, YA-25D.  
 Key 4: JMA logo, USA GB codes, ABUS, BENDIX, CAB, CHICAGO, COLE HERSEE brands, profiles YA-27, YA-27D, ...500-550.



**PARA-FOR:**

YALE  
(D-GB-USA)

**YALE**

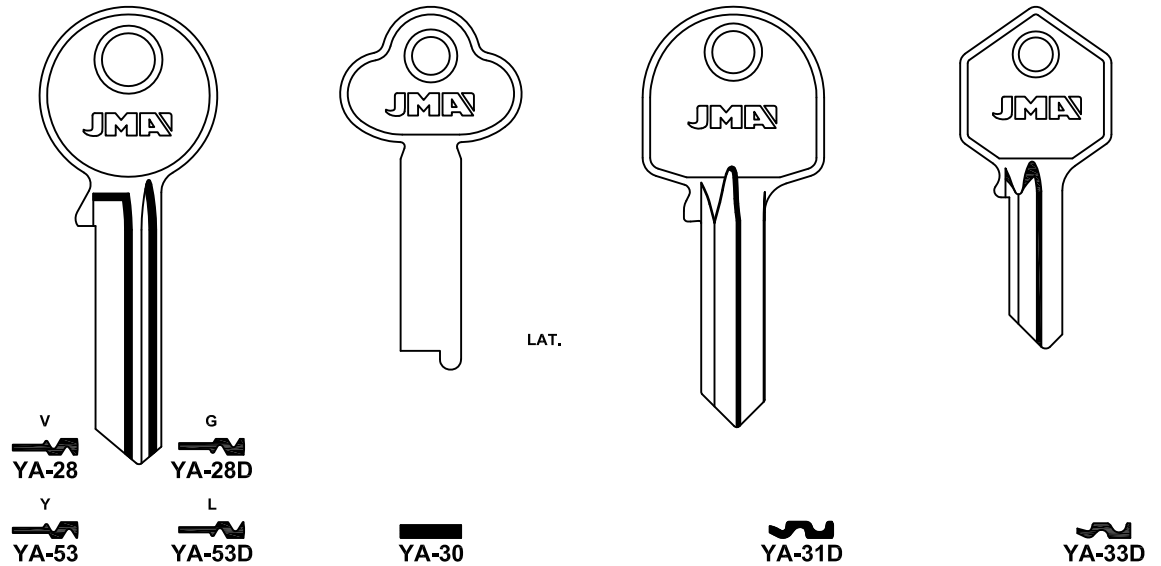

**YALE**

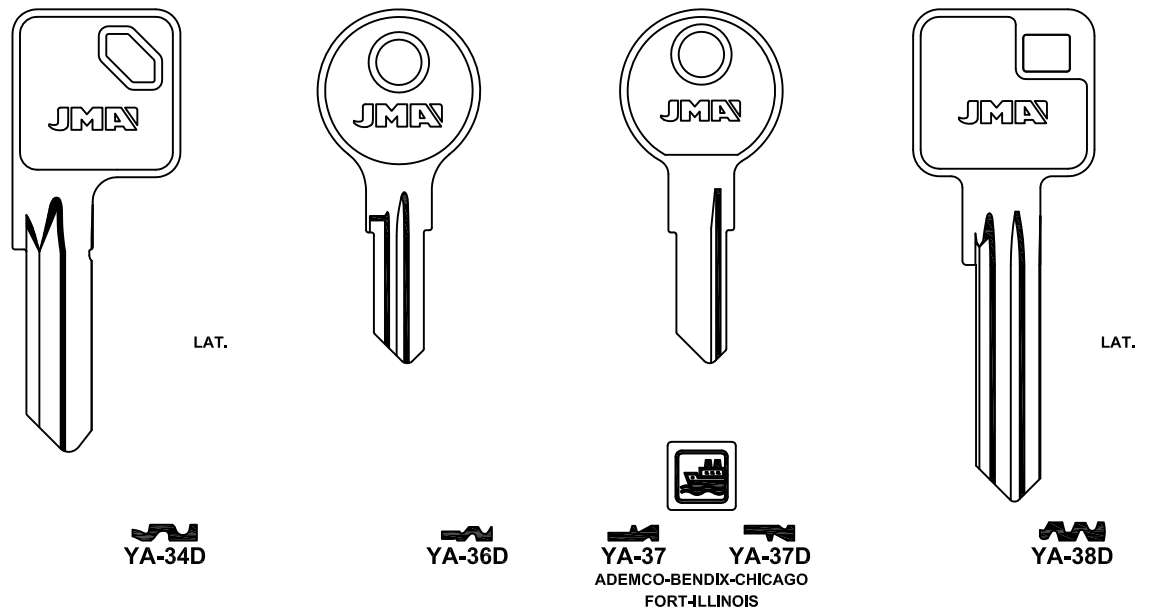

**YALE**

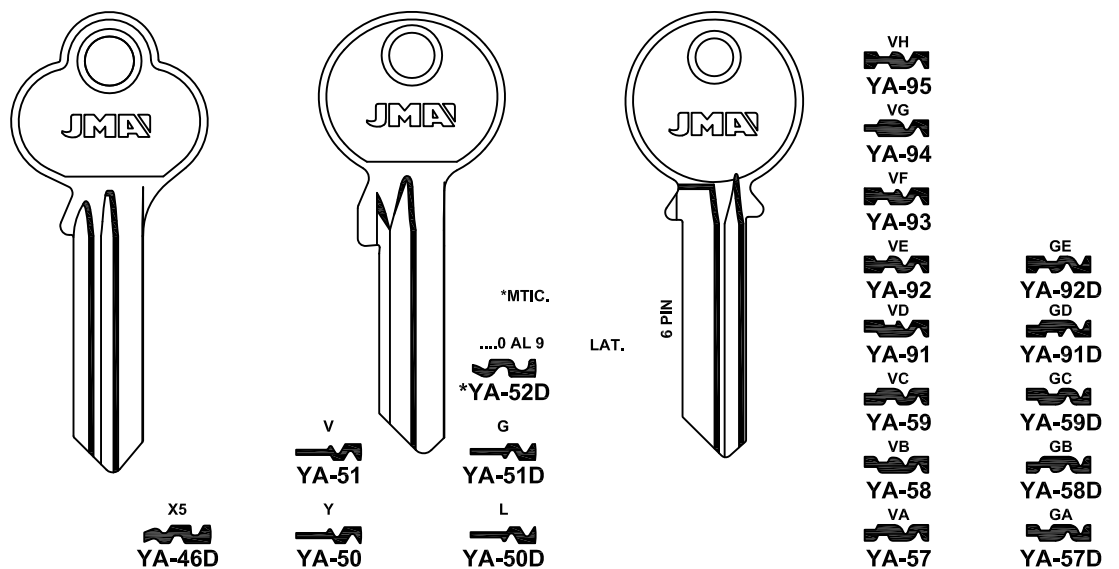

## YALE

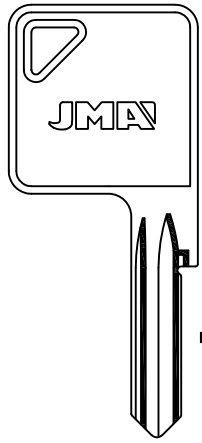

LAT.

YA-72

DRAPER

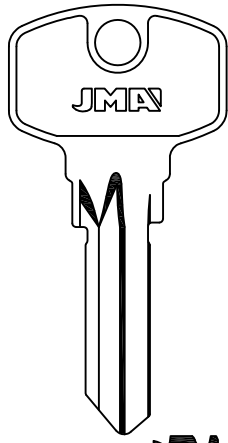

YA-79D

YA-272D

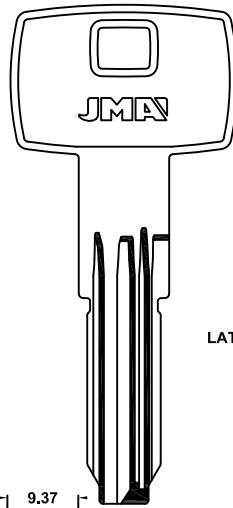

9.37  
2.85  
YA-81

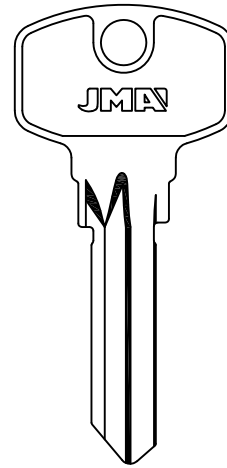

LAT.

YA-85D

PARA-FOR:

YALE  
(D-GB-USA)

## YALE

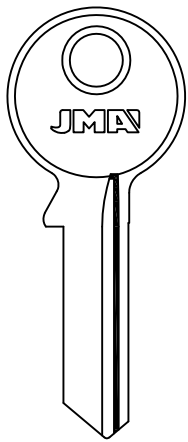

RSA

YA-88

ASSA ABLOY

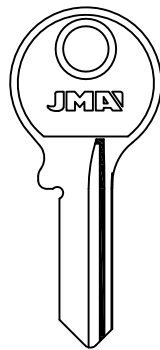

RSA

YA-89

ASSA ABLOY

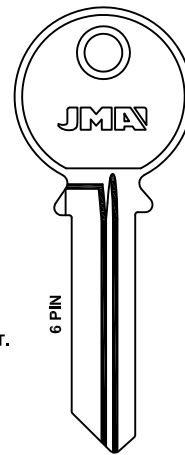

LAT.

6 PIN

LG  
YA-103D

LF  
YA-102D

LE  
YA-101D

LD  
YA-100D

LC  
YA-99D

LB  
YA-98D

LA  
YA-97D

## YALE

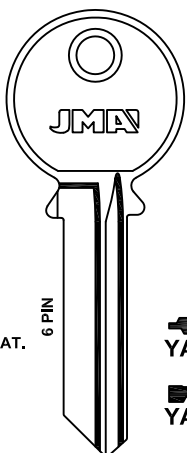

LAT.  
6 PIN

YG  
YA-113

YF  
YA-112

YE  
YA-111

YB  
YA-108

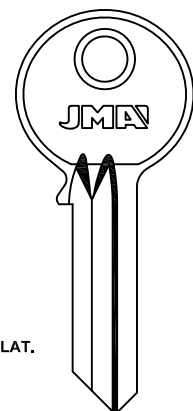

LAT.

YA-142D

BKS

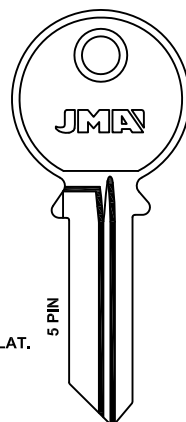

LAT.  
5 PIN

GA  
YA-186D

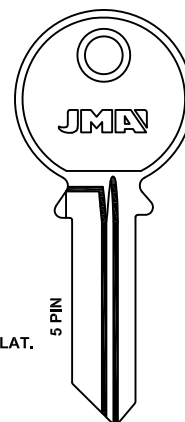

LAT.  
5 PIN

LG  
YA-212D

LE  
YA-210D

LD  
YA-209D

LC  
YA-208D

LA  
YA-206D

**JMA**<sup>®</sup>

Copyright by Alejandro Altuna S.A. 2014



ATENCIÓN: Concerniente a las marcas y denominaciones comerciales ver nota en índice.  
ATTENTION: Concerning the marks and commercial denominations see note in index.  
ATTENTION: Concernant les marques et dénominations commerciales voir la note dans l'index.  
ACHTUNG: Beziehen auf die marke und handelsname sehen sie die notiz im index.

**PARA-FOR:**

YALE  
(D-GB-USA)  
YARDENI (IL)  
YETI (RC)

**YALE**

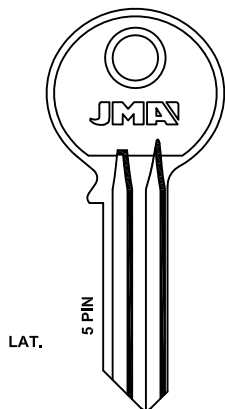

LAT.

- VF  
YA-221
- VE  
YA-220
- VD  
YA-219
- VB  
YA-217
- VA  
YA-216

BKS

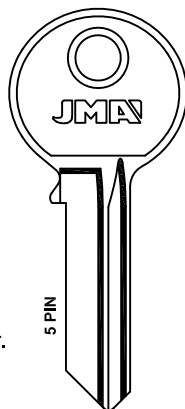

LAT.

- YH  
YA-232
- YE  
YA-229
- YD  
YA-228
- YC  
YA-227
- YB  
YA-226
- YA  
YA-225

BKS

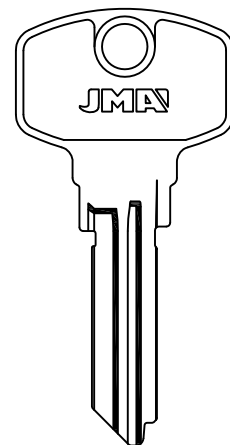

- KTM  
YA-273D

**YARDENI**

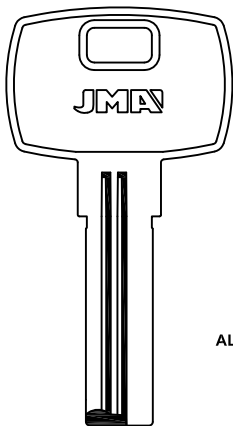

ALP.

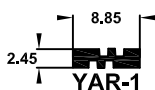

YAR-1

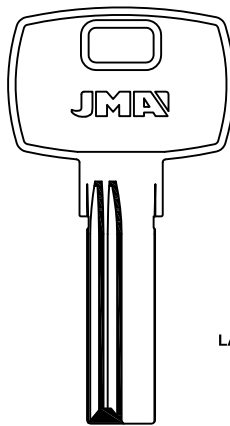

LAT.

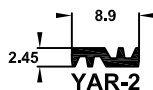

YAR-2

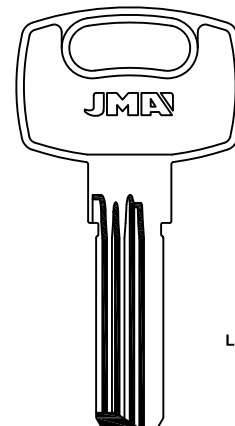

LAT.



YAR-3

**YETI**

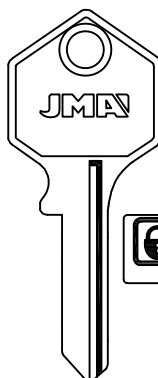

- AKIRA
- ASIA
- BELL
- DEHA
- FOUR CIRCLE
- HAIDE
- HEMY
- HERMES
- HEAD
- LOTUS
- RAM
- ROYAL
- SANCHUN
- SWAN
- VELO
- VISO
- WINFIELD
- SEZAN



YET-1



YET-1D

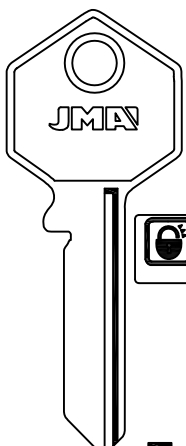

- AKIRA
- ASIA
- BELL
- DEHA
- FOUR CIRCLE
- HAIDE
- HEMY
- HERMES
- HEAD
- LOTUS
- RAM
- ROYAL
- SANCHUN
- SWAN
- VELO
- VISO
- WINFIELD
- SEZAN



YET-2



YET-2D

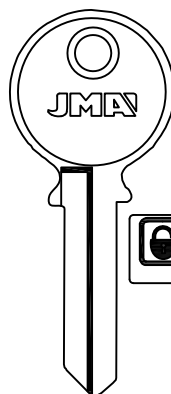

- AKIRA
- ASIA
- BELL
- DEHA
- FOUR CIRCLE
- HAIDE
- HEMY
- HERMES
- HEAD
- LOTUS
- RAM
- ROYAL
- SANCHUN
- SWAN
- VELO
- VISO
- WINFIELD
- SEZAN



YET-3D



YET-15

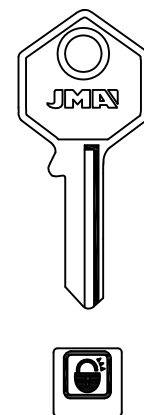

- AKIRA
- ASIA
- BELL
- DEHA
- FOUR CIRCLE
- HAIDE
- HEMY
- HERMES
- HEAD
- LOTUS
- RAM
- ROYAL
- SANCHUN
- SWAN
- VELO
- VISO
- WINFIELD
- SEZAN



YET-4



YET-4D



**YETI**

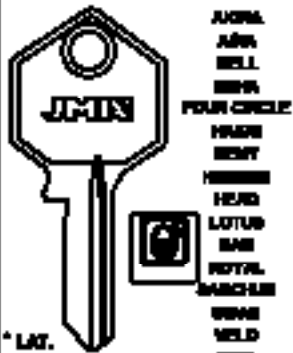

ACMA  
AMA  
BELL  
BINA  
FOUR CIRCLE  
HARR  
HENRY  
HERRER  
HERR  
LOTUS  
RAM  
ROYAL  
SARGENT  
SWAN  
VELD  
VINO  
WINDFIELD  
WISMAN

LAT.

YET-6

YET-6D

YET-6

YET-6D

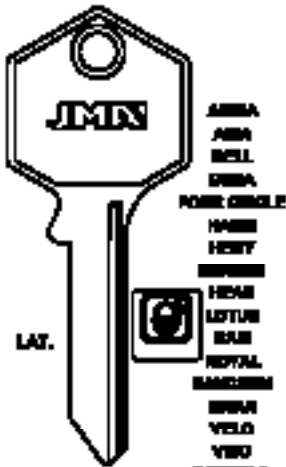

ACMA  
AMA  
BELL  
BINA  
FOUR CIRCLE  
HARR  
HENRY  
HERRER  
HERR  
LOTUS  
RAM  
ROYAL  
SARGENT  
SWAN  
VELD  
VINO  
WINDFIELD  
WISMAN

LAT.

YET-7

YET-7D

YET-7

YET-7D

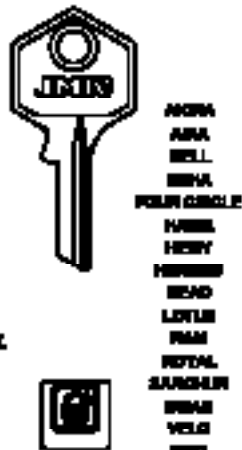

ACMA  
AMA  
BELL  
BINA  
FOUR CIRCLE  
HARR  
HENRY  
HERRER  
HERR  
LOTUS  
RAM  
ROYAL  
SARGENT  
SWAN  
VELD  
VINO  
WINDFIELD  
WISMAN

LAT.

YET-4

YET-4D

YET-4

YET-4D



ACMA  
AMA  
BELL  
BINA  
FOUR CIRCLE  
HARR  
HENRY  
HERRER  
HERR  
LOTUS  
RAM  
ROYAL  
SARGENT  
SWAN  
VELD  
VINO  
WINDFIELD  
WISMAN

LAT.

YET-9

YET-9D

YET-9

YET-9D

**YETI**



ACMA  
AMA  
BELL  
BINA  
FOUR CIRCLE  
HARR  
HENRY  
HERRER  
HERR  
LOTUS  
RAM  
ROYAL  
SARGENT  
SWAN  
VELD  
VINO  
WINDFIELD  
WISMAN



YET-10

YET-10D



ACMA  
AMA  
BELL  
BINA  
FOUR CIRCLE  
HARR  
HENRY  
HERRER  
HERR  
LOTUS  
RAM  
ROYAL  
SARGENT  
SWAN  
VELD  
VINO  
WINDFIELD  
WISMAN

LAT.

YET-11

YET-11D

YET-11

YET-11D



ACMA  
AMA  
BELL  
BINA  
FOUR CIRCLE  
HARR  
HENRY  
HERRER  
HERR  
LOTUS  
RAM  
ROYAL  
SARGENT  
SWAN  
VELD  
VINO  
WINDFIELD  
WISMAN



YET-12



YET-17D

LOW COPY-17D-17D-17D

**YUN HUAN**



YUH-10



YUH-20

**YWS**



YW-1P

AMUS

**ZADI**



ZA-1

AMUS

**PARA-FOR:**

- YETI (RC)
- YUN HUAN (PRC)
- YMS (TW)
- ZADI (I)





**PARA-FOR:**

ZADI (I)

ZENI (GB)

**ZADI**

**ZENI**

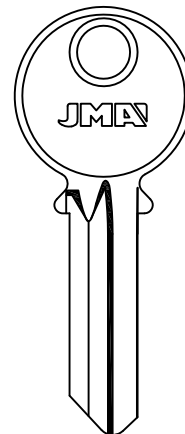
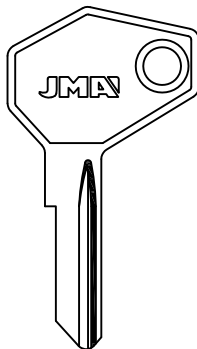
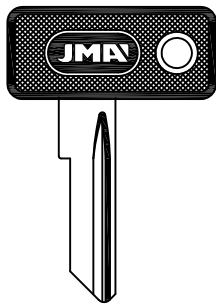

....1-1625  
....5001-6278  
E...1-710

....1-1625  
....5001-6278  
E...1-710



**ZA-1.P**

**ZA-12**

BRETER

BRETER



**ZEN-1D**



# **LLAVES PARA VEHÍCULOS**

*IBILGAILUENTZAKO GILTZAK*

*KEYS FOR VEHICLES*

*CLES POUR VEHICULES*

*FAHRZAUGESCHLÜSSEL*



**THE KEY TO EXCELLENCE**  
*GLOBALLY UNLOCKING MILLIONS OF DOORS DAILY*

**PARA-FOR:**

ABSA (E)

ABUS (D)

**ABSA**

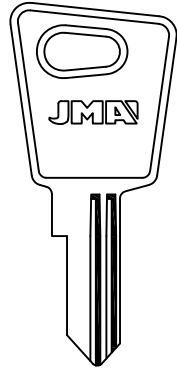

M.LUNA

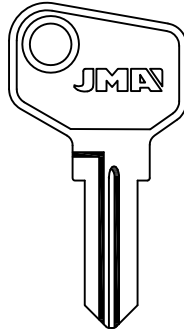

PROAUTO

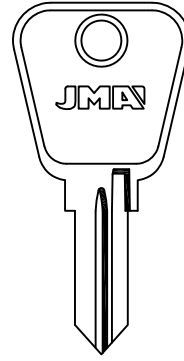

FROSER

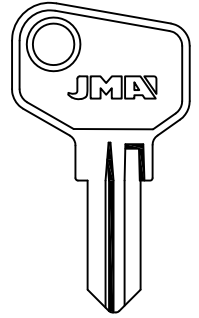

ARREGUI

**ABSA**

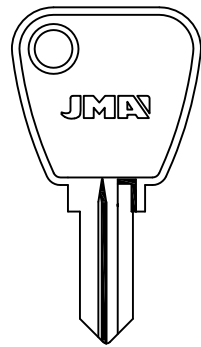

AB-10I

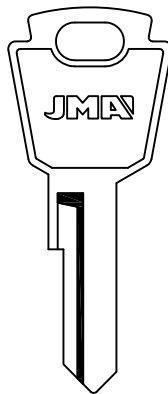

SIM-1200

**ABUS**

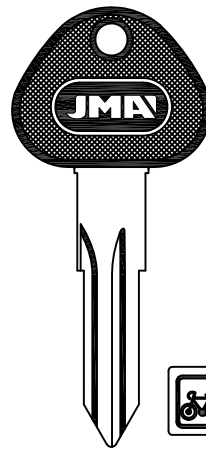

Z71...1-1043  
Z72...1-1043



ABU-18.P ABU-18D.P

BUFFO

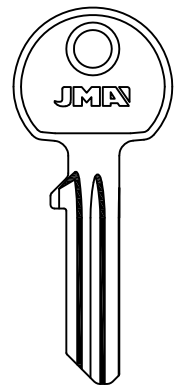

Z71...1-1043  
Z72...1-1043



ABU-19D

BUFFO

**ABUS**

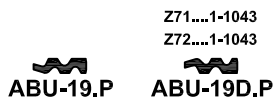
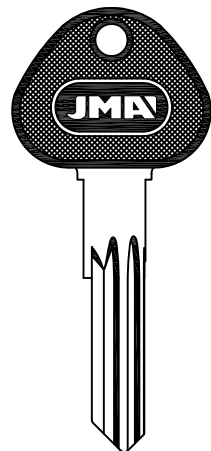

ABU-19.P ABU-19D.P

BUFFO

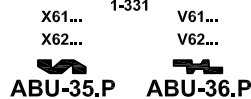
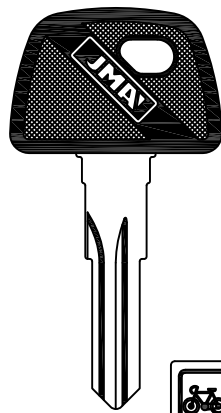

ABU-35.P ABU-36.P

BUFFO

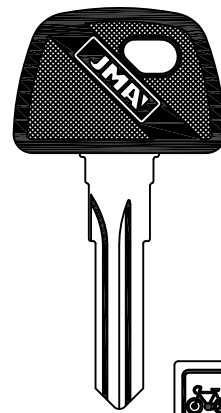





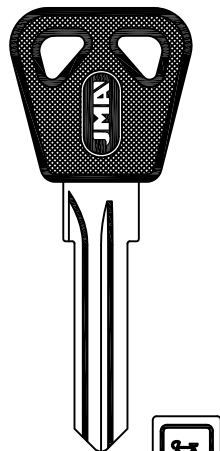





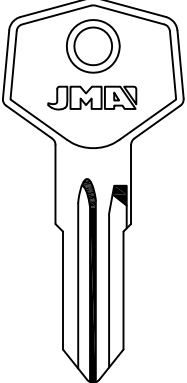

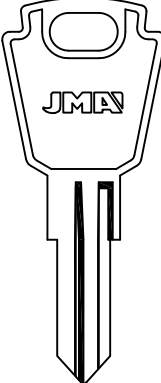
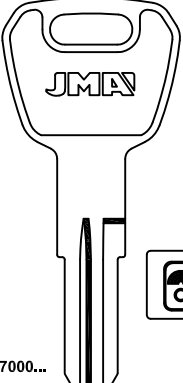

ABU-64.P ABU-65.P

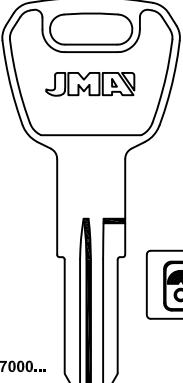
BUFFO





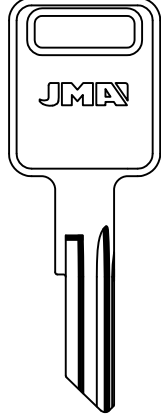







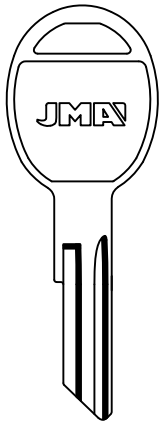

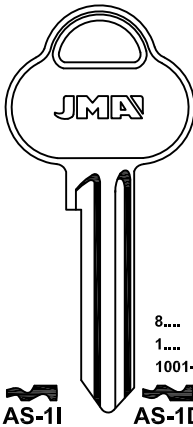
ABU-72.P



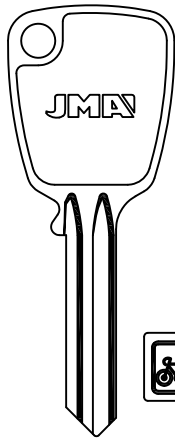



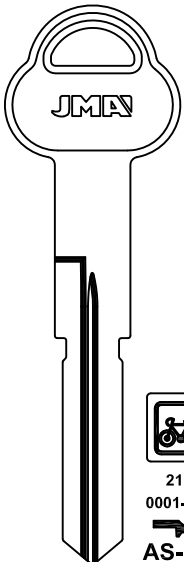



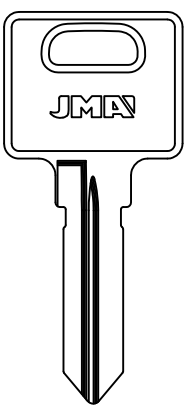

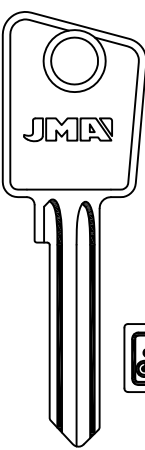

AKS	ALPHA		AMERICAN MO.
 <p>KA 001-100</p>  <p>AKS-1 VOLVO</p>	  <p>7000...</p>  <p>ALP-2</p>  <p>ALP-2D</p> <p>JD-LINCE-MONACOR SANY-VISONIC</p> <p>S...301-600</p>  <p>ALP-1</p>  <p>ALP-1D</p> <p>FEB</p>	  <p>7000...</p>  <p>ALP-2</p>  <p>ALP-2D</p> <p>JD-LINCE-MONACOR SANY-VISONIC</p> <p>S...301-600</p>  <p>ALP-6</p>  <p>ALP-6D</p> <p>FEB</p>	 <p>LAT.</p>  <p>AMM-1</p>

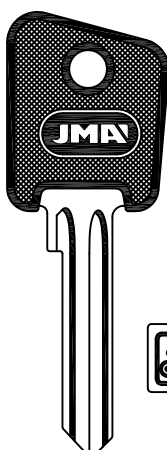
**PARA-FOR:**

- AKS (D)
- ALPHA (J)
- AMERICAN MOTORS (USA)
- ASSA (S)
- AXA (S)

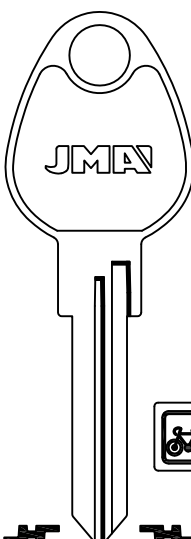
AMERICAN MO.	ASSA		
 <p>LAT.</p>  <p>AMM-2</p>	 <p>8... 1... 1001-3300</p>  <p>AS-1I</p>  <p>AS-1D</p> <p>7... 6... 1001-3300</p>  <p>AS-24</p>  <p>AS-24D</p> <p>SAAB-VOLVO</p>	  <p>.... 700-7999</p>  <p>AS-2I</p> <p>.... 6000-8999</p>  <p>AS-2D</p>	  <p>21... 0001-9999</p>  <p>AS-17D</p> <p>BICICLETTA CYCLES</p>

ASSA		AXA
 <p>21... 0001-9999</p>  <p>AS-19D</p>	  <p>7000-7999 A... 7000-7999</p>  <p>AS-21</p> <p>8000-9999 A... 9000-9999</p>  <p>AS-21D</p>	  <p>7000-7999 A... 7000-7999</p>  <p>AS-21.P</p> <p>8000-9999 A... 9000-9999</p>  <p>AS-21D.P</p>
		  <p>AX-1</p>  <p>AX-1D</p>



**PARA-FOR:**

AXA (S)

AZU (E)

BASCO (USA)

BLAU (D)

**AXA**

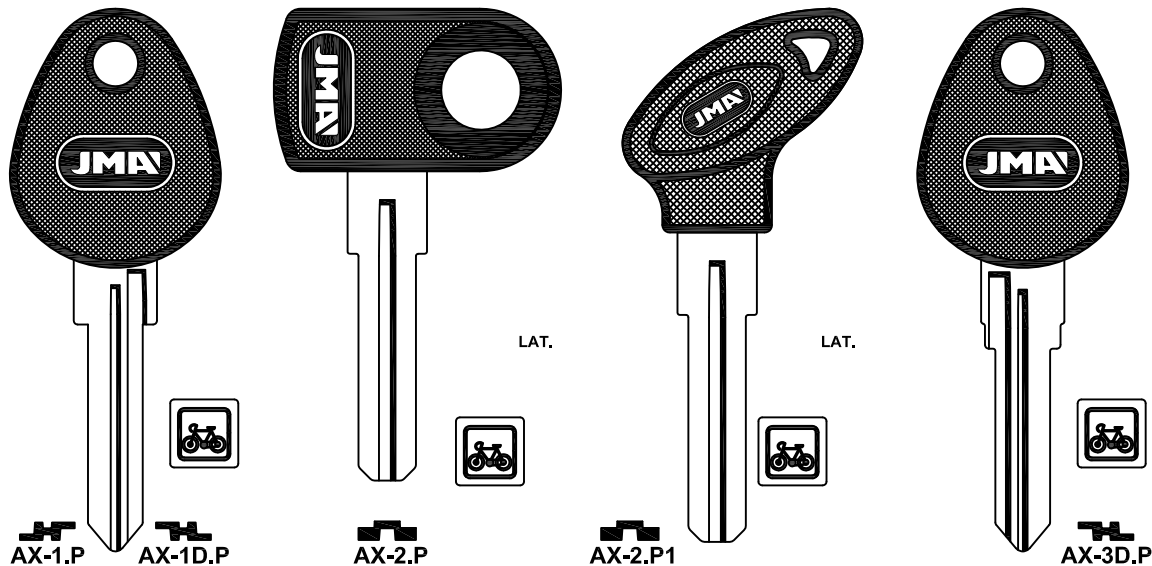

**AXA      AZU      BASCO**

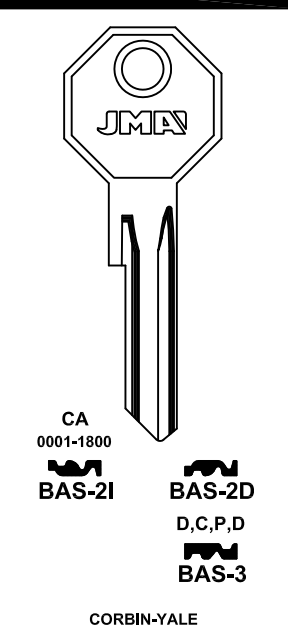
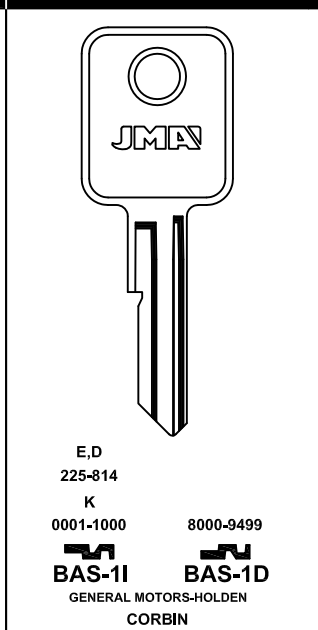
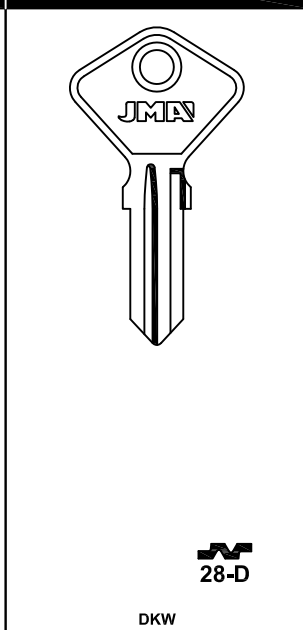
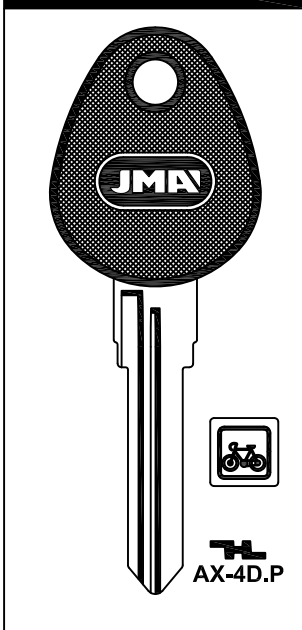

**BASCO**

**BLAU**

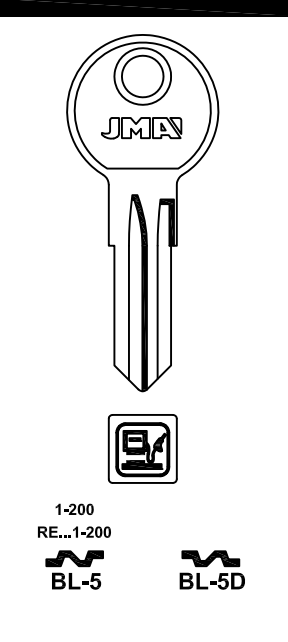
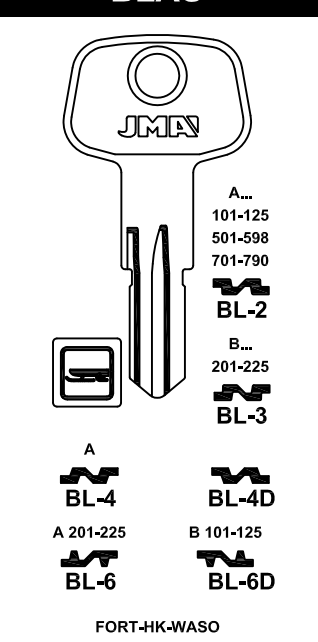
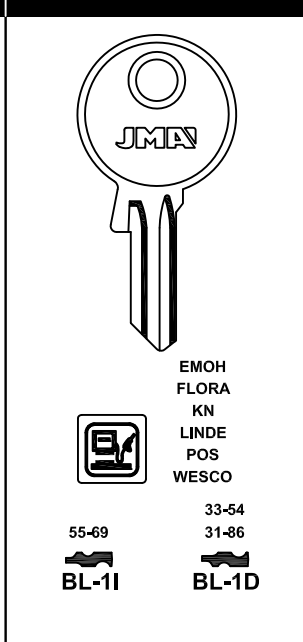
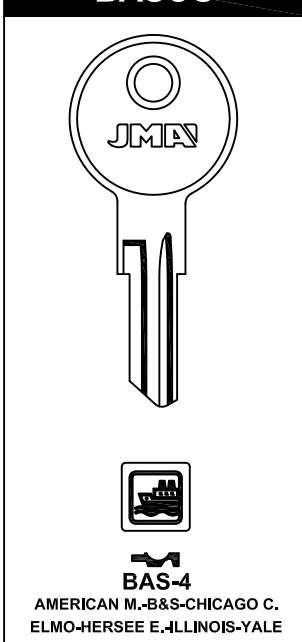

**BOMBARDIER**

**BOMORO**

**BOSCH**

**PARA-FOR:**

LAT.

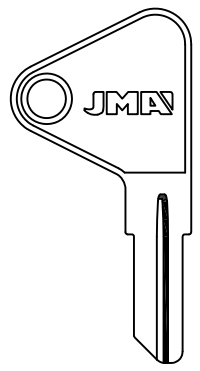

**BOB-1D**

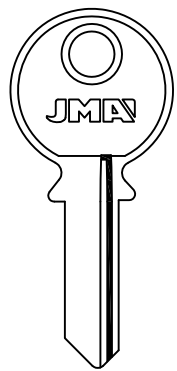

**BOM-2 BOM-2D**

LAPORTE-PRESTA

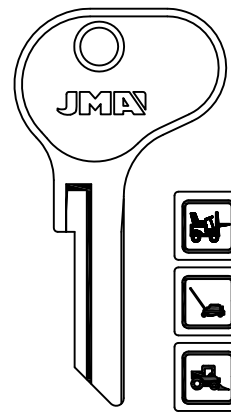

E, M, N, U, H, K  
001-100  
HG, N 140-189  
HG 040-100

**BH-1**

NEIMAN

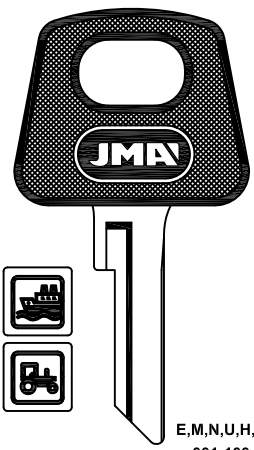

E, M, N, U, H, K  
001-100  
HG, N 140-189  
HG 040-100

**BH-1.P**

NEIMAN

- BOMBARDIER (USA)
- BOMORO (D)
- BOSCH (D)
- BRABANTIA (E)
- B.&S. (USA)

**BOSCH**

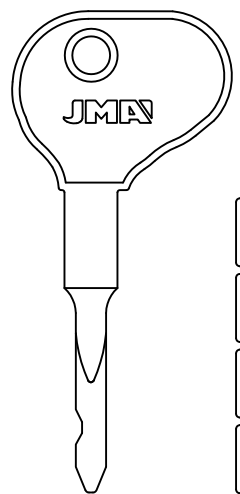

**BH-2**

FIAT IVECO-MACK M-SCANIA

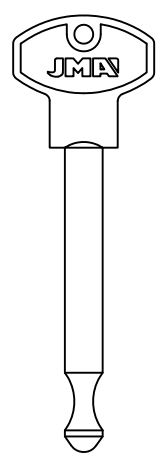

**BH-3**

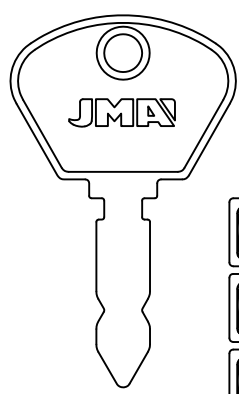

7,1 1,95  
**BH-4**

DISALCAR-OM IVECO-SULKY  
KOLB-POLAR

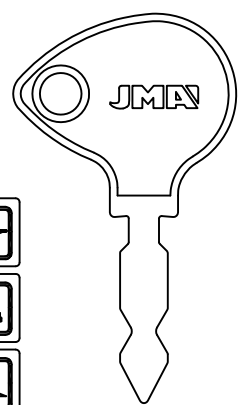

6,3 2  
**BH-5**

**BOSCH**

**BRABANTIA**

**B & S**

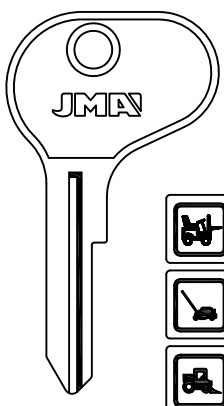

**BH-6**

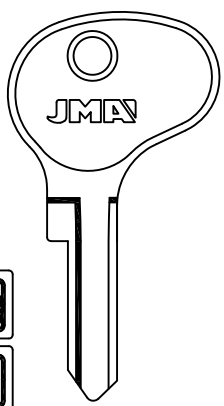

MS-S  
1-50  
**BH-8**

KOLB-LAPORTE

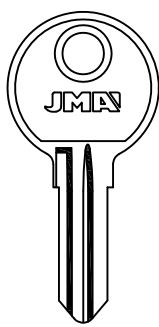

**BRA-2**

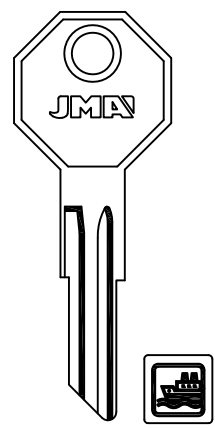

N  
1501-1700  
NA  
001-200  
**BS-11**

AMERICAN MOTORS-MACK  
DEXTER



**PARA-FOR:**

- B.&S. (USA)
- BURG (D)
- CAMA (I)
- CASELLAS (E)
- CATERPILLAR (USA)
- CEM (GB)

**BRIGGS & STRATTON**

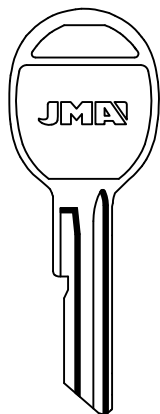

E...225-814  
L...1-1000

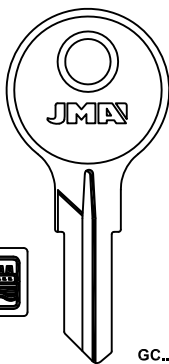

LAT.

A...250-1500  
AP...250-1500  
B...250-1500  
C...1251-1700  
CB...250-1500  
DC-EP...250-699  
P...250-1500

GC...  
101-150  
HC...  
0-499

**BS-4D**

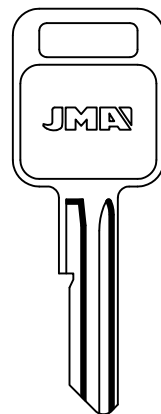

D  
225-814  
K  
01-1000

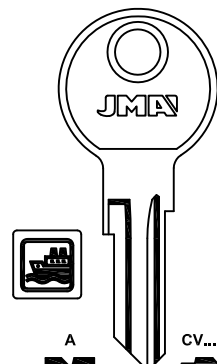

LAT.

A CV...1-1500  
\* BS-7 \* BS-7D

D C  
BS-8 BS-8D

E F  
BS-9 BS-9D

**BURG**

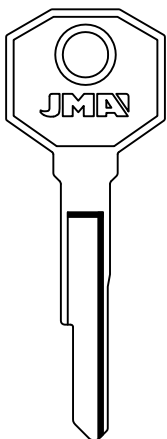

**BUR-6**

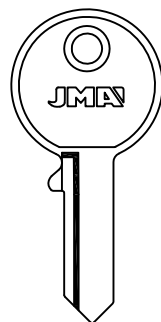

**BUR-30D**

MOFA

**CAMA**

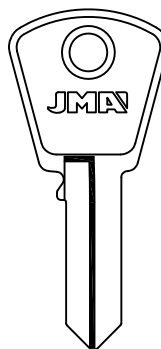

**CAM-1D**

FIST

**CASELLAS**

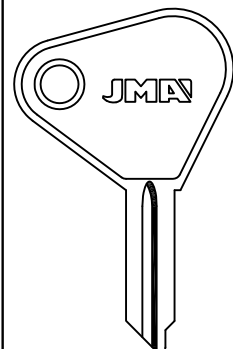

**CAS-1D**

OSSA

**CATERPILLAR**

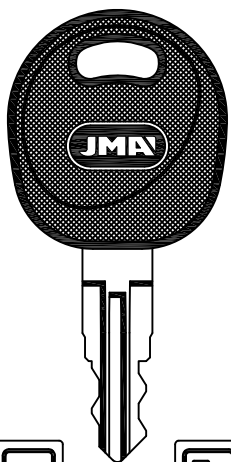

**CAT-1.P**

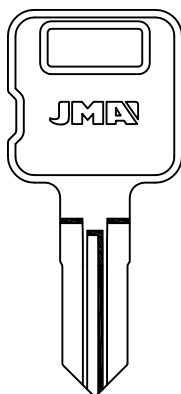

**CAT-2**

LAT.

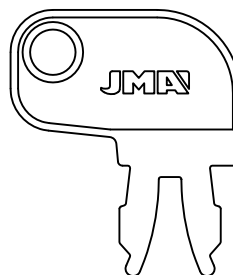

**CAT-3**





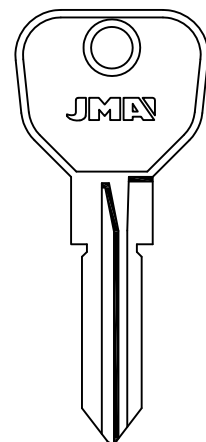

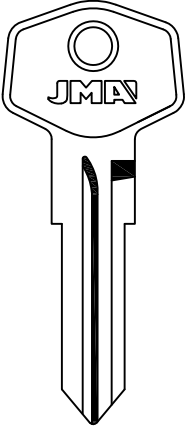

LAT.

**CEM**

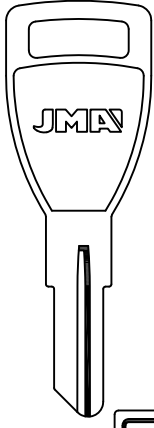

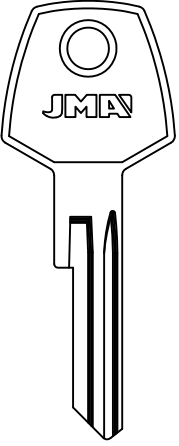

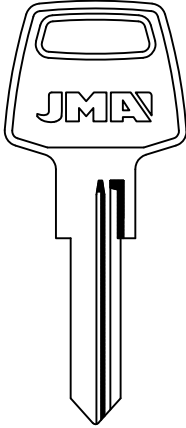





**CEM-BP**

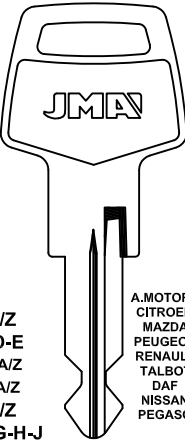

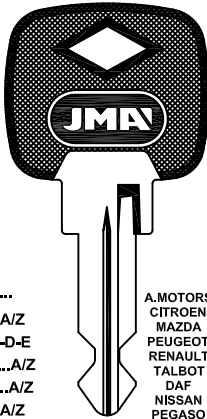

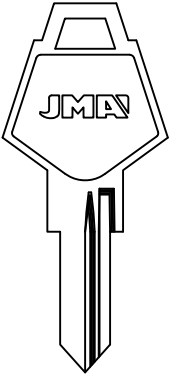

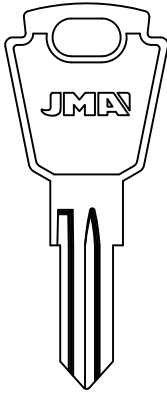

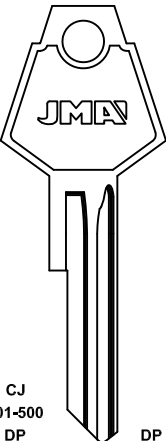

CEM	CESSNA	CHRYSLER	
 <p>JMA</p> <p>JC 001-852</p> <p>AK 0001-1000</p> <p> <b>CEM-JC</b> DAIMLER-JAGUAR-ROVER-VOLVO</p>	 <p>JMA</p> <p></p> <p>500-999</p> <p> <b>CN-1D</b></p> <p>PJ</p>	 <p>JMA</p> <p> <b>CHR-1</b></p> <p>YALE</p>	 <p>JMA</p> <p> <b>CHR-2</b></p> <p>ROSS</p>

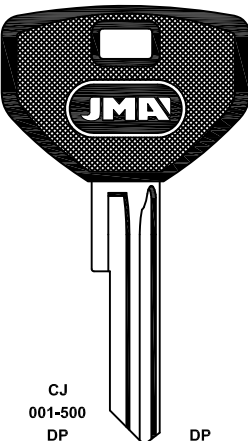
**PARA-FOR:**

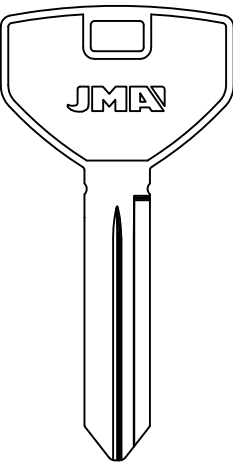
- CEM (GB)
- CESSNA (USA)
- CHRYSLER (USA)

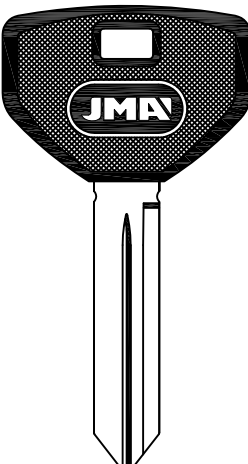
CHRYSLER			
 <p>JMA</p> <p>..... .....A/Z B-C-D-E .1/9.....A/Z .1/9.....A/Z .....A/Z B-D-E-G-H-J .1/9.....A/Z .1/9.....A/Z E-M-N-P-R</p> <p> <b>CHR-3</b></p> <p>CLAUSOR-NEIMAN</p>	 <p>JMA</p> <p>..... .....A/Z B-C-D-E .1/9.....A/Z .1/9.....A/Z .....A/Z B-D-E-G-H-J .1/9.....A/Z .1/9.....A/Z E-M-N-P-R</p> <p> <b>CHR-3.P</b></p> <p>CLAUSOR-NEIMAN</p>	 <p>JMA</p> <p> <b>CHR-5</b></p> <p>NISSAN-PEGASO ROSS</p>	 <p>JMA</p> <p>Z 001-224</p> <p> <b>CHR-6</b></p> <p>W 001-224</p> <p> <b>CHR-6D</b></p> <p>KIFERM-PJ</p>

CHRYSLER			
 <p>JMA</p> <p>CJ 001-500</p> <p>DP 0001-1400</p> <p>EP 0001-3000</p> <p> <b>CHR-7</b></p> <p>CHRYSLER YALE</p>	 <p>JMA</p> <p>DP 0001-1400</p> <p>EP 0001-3000</p> <p> <b>CHR-8.P</b></p> <p>CHRYSLER YALE</p>	 <p>JMA</p> <p>F.... G.... 0000-1394</p> <p> <b>CHR-9</b></p> <p>AMERICAN MOTORS-CHRYSLER-JEEP YALE</p>	 <p>JMA</p> <p>F.... G.... 0000-1394</p> <p> <b>CHR-9.P</b></p> <p>AMERICAN MOTORS-CHRYSLER-JEEP YALE</p>





**PARA-FOR:**

CHRYSLER  
(USA)

CLAUSOR (E)

**CHRYSLER**

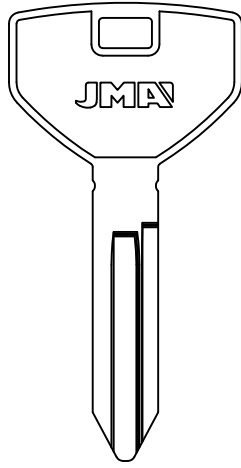

J....  
0001-3580



**CHR-10**

AMERICAN MOTORS-CHRYSLER-JEEP  
YALE

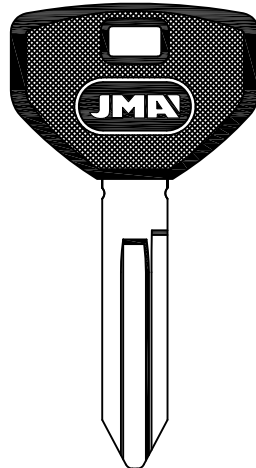

J....  
0001-3580



**CHR-10.P**

AMERICAN MOTORS-CHRYSLER-JEEP  
YALE

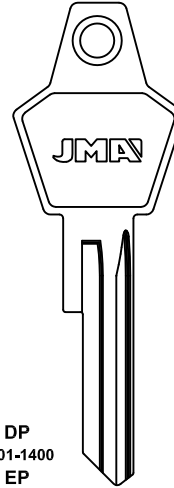

DP  
0001-1400  
EP  
0001-3000



**CHR-11**

CHRYSLER  
YALE

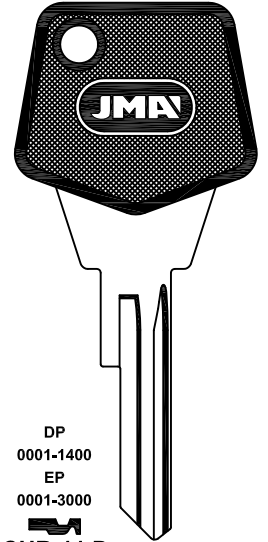

DP  
0001-1400  
EP  
0001-3000



**CHR-11.P**

CHRYSLER  
YALE

**CHRYSLER**

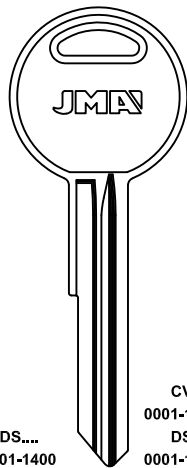

DS....  
0001-1400  
ES....  
0001-3000



**CHR-12**

CHRYSLER

BRIGGS & STRATTON

CV  
0001-1500  
DS  
0001-1500  
ES  
0001-1500



**CHR-13D**

CHRYSLER

BRIGGS & STRATTON

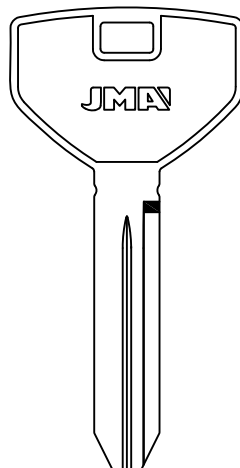

L.... 1-3580



**CHR-14**

CHRYSLER

BRIGGS & STRATTON-YALE

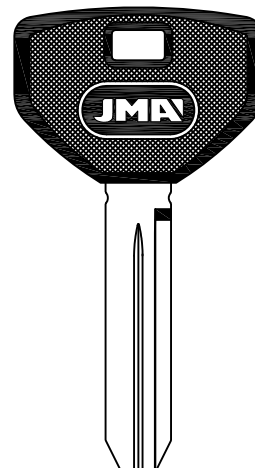

L.... 1-3580



**CHR-14.P**

CHRYSLER

BRIGGS & STRATTON-YALE

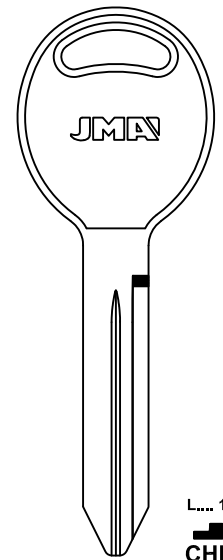

L.... 1-3580



**CHR-15**

CHRYSLER

BRIGGS & STRATTON-YALE

**CHRYSLER**

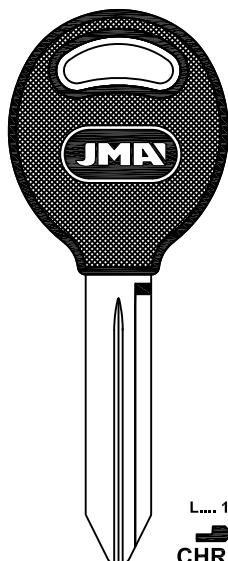

L.... 1-3580



**CHR-15.P**

CHRYSLER

BRIGGS & STRATTON-YALE

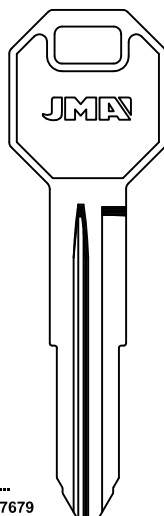

E....  
5001-7679



**CHR-17**

CHRYSLER

BRIGGS & STRATTON-YALE

**CLAUSOR**

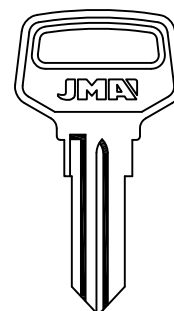

ALU.



**CL-11**

BRABANTIA

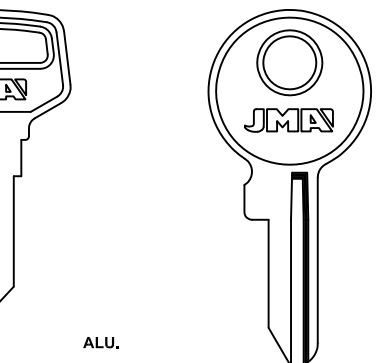

**CL-21**

EBRO-CAGIVA-LINCE-MAICO  
MONTESA-OSSA-PIAGGIO VESPA

**CL-2D**



## CLAUSOR

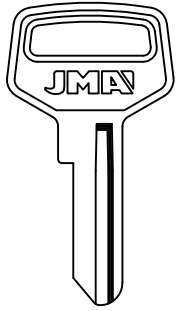

**CL-3I**

EBRO-CAGIVA-LINCE-MAICO  
MONTESA-OSSA-PIAGGIO VESPA

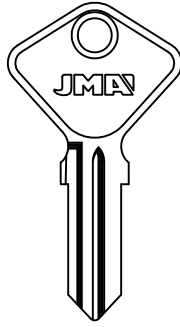

**CL-4I**

JEEP

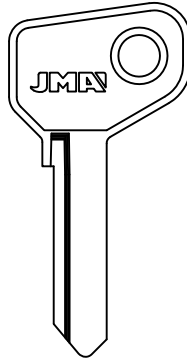

**CL-5D**

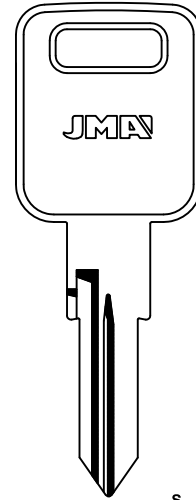

**CL-6**

SEAT

## PARA-FOR:

CLAUSOR (E)

CLICK (RA)

CLUM (USA)

COBRA (I)

## CLAUSOR

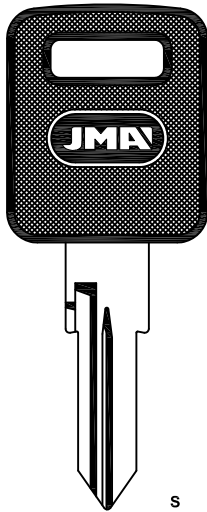

**CL-6.P**

SEAT

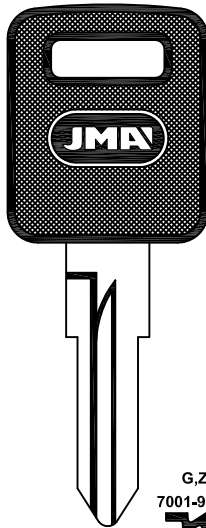

G,Z  
7001-9956  
**CL-7.P**

SEAT  
GIOBERT

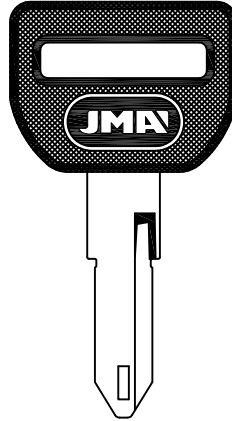

M,N,P,R,S  
1/9...A/Z  
**CL-8.P**

CITROEN

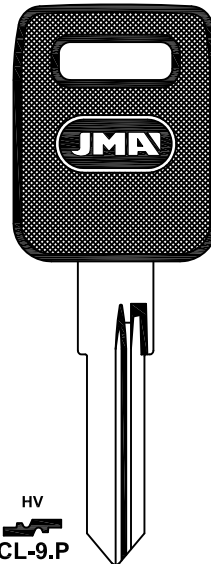

HV  
**CL-9.P**

SEAT

## CLAUSOR

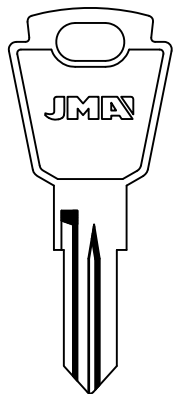

**SIM-900**

## CLICK

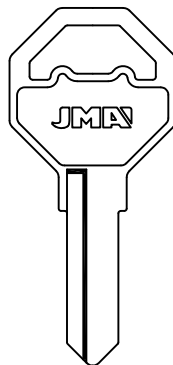

**CLI-1D**

## CLUM

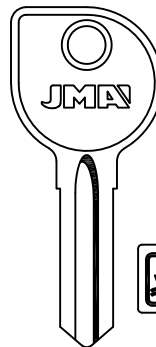

**CLU-1I**

**CLU-1D**



\* LAT.

**CLU-2**

**CLU-3**

\* **CLU-4**

\* **CLU-5**

MERCURY

## COBRA

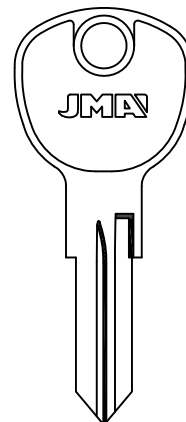

**COB-1**













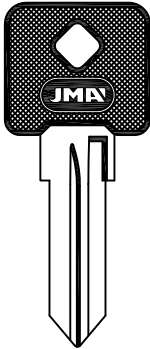
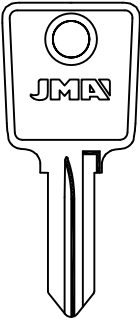
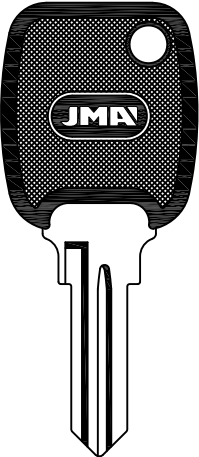
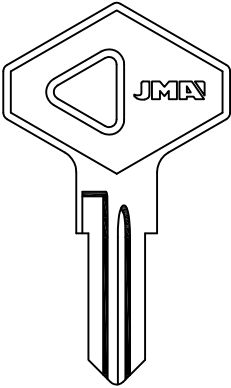







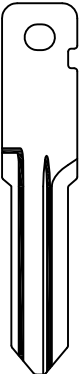

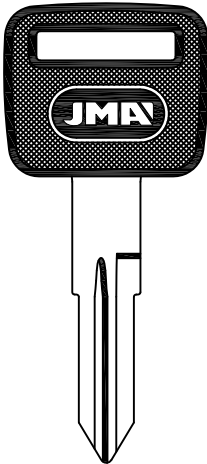

**PARA-FOR:**

COBRA (I)

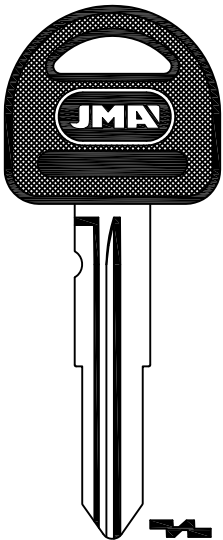
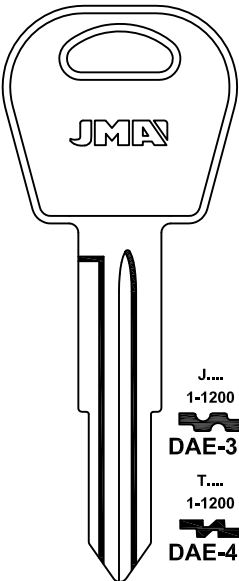
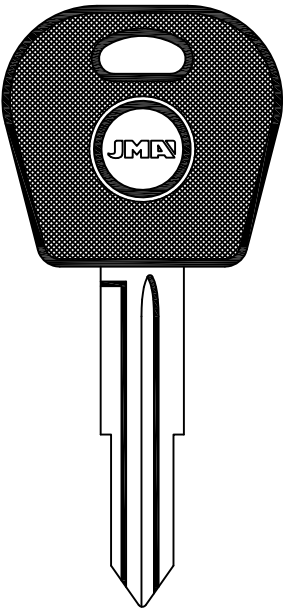
DACIA (R)

DAELIM (K)

DAEWOO (K)

COBRA		DACIA	
			
 	 		
<b>COB-1.P</b>	<b>COB-2</b>	<b>DAC-1D.P</b>	<b>DAC-2D</b>
DACIA			DAELIM
			
	 		
<b>DAC-3DC1</b>	<b>DAC-4DC1</b> <b>DAC-5C1</b>	<b>DAL-1.P</b>	<b>DAE-1.P</b> DAEWOO
HUF			
DAEWOO			
			
	J... 1-1200  <b>DAE-3D</b> T... 1-1200  <b>DAE-4D</b>	V... 1-1200  <b>DAE-4.P1</b>	J... 1-1200  <b>DAE-3D.P1</b> T... 1-1200  <b>DAE-4D.P1</b>
<b>DAE-2D.P</b> DAEWOO			



**DAEWOO**

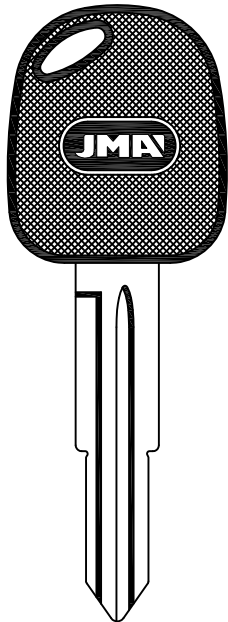

DAE-3.P2      J...  
1-1200  
DAE-3D.P2

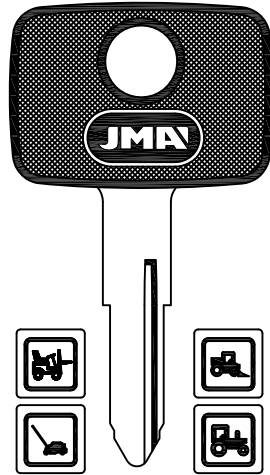

DAE-5.P

**DAIHATSU**

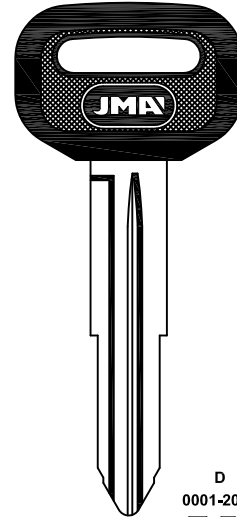

D  
0001-2000  
DAI-1.P  
BERTONE-DAIHATSU

**PARA-FOR:**

- DAEWOO (K)
- DAIHATSU (J)
- DARMIX (F)
- DAV (F)
- DOBLE G (ARG)
- DOBLINA (D)
- DOM (D)

**DAIHATSU**

**DARMIX**

**DAV**

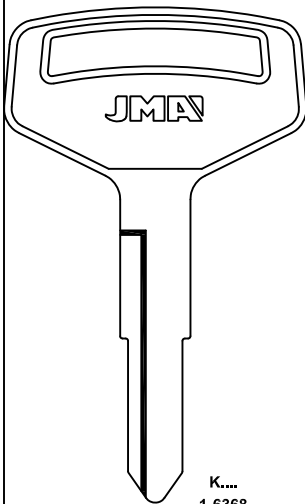

K...  
1-6368  
DAI-2D

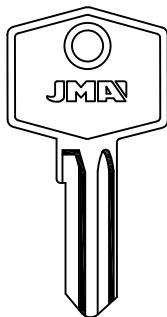

DAR-1

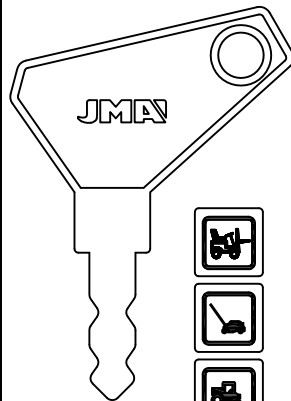

6,1 1,95  
DAV-1  
DAF-MACK-RENAULT SAVIEM

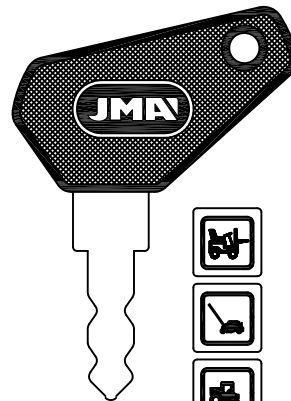

6,1 1,95  
DAV-1.P  
DAF-MACK-RENAULT SAVIEM

**DOBLE G**

**DOBLINA**

**DOM**

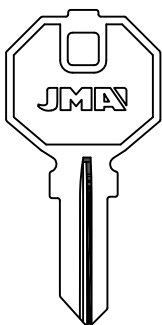

GG-1D

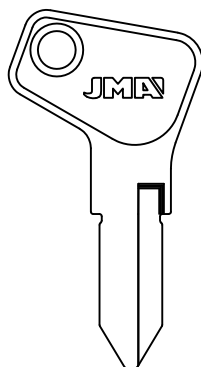

DOB-1      DOB-1D  
.....6  
10000-44031  
DOB-2      DOB-2D  
TRABANT-WARTBURG

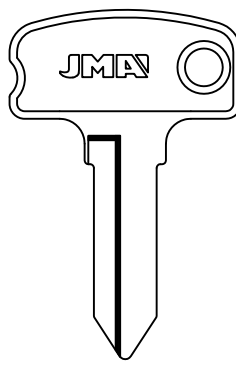

10000-44031  
....26      ....25  
DOB-3      DOB-3D  
TRABANT-WARTBURG

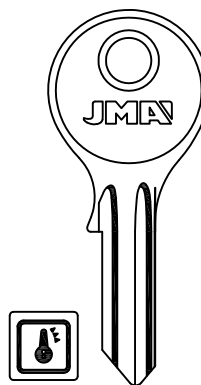

EV...1-2840  
GS...1-1000  
FT...1-1000  
CQ...301-400  
....1-1000  
EV...1-2840  
DOM-9      DOM-9D  
NOBO



**PARA-FOR:**

- DOM (D)
- DUBOIS (F)
- ECHO (I)
- EUROLOCKS (B)
- FAAB (I)
- FAB (CZ)

DOM		DUBOIS		ECHO	
 FA-GZ 0001-3948  <b>DOM-14D</b>	 <b>DOM-38D</b>	A... 1-2-3  <b>DU-1</b> FLAMBO-YVEL	 <b>ECH-1</b>		
EUROLOCKS		FAAB		FAB	
 LAT.  7,6 2,9 <b>EU-12</b> HOBBY-HYMER	 2 100-309  <b>FAB-1</b>	 4... 100-309  <b>FAB-2</b>	29,8 mm  <b>SKO-1</b> SKODA		
FAB					
29,8 mm  <b>SKO-1.P</b> SKODA	27,8 mm  <b>SKO-2</b> SKODA	4AB...1-2780  <b>SKO-3I</b> SKODA	4AB...1-2780  <b>SKO-3I.P</b> SKODA	23,7 mm  <b>SKO-4</b> SKODA	



**FAB**

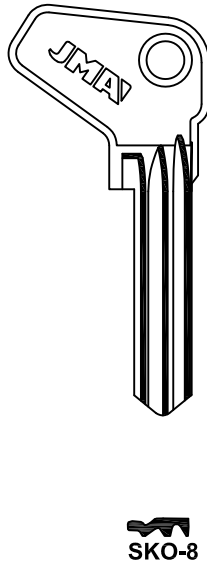
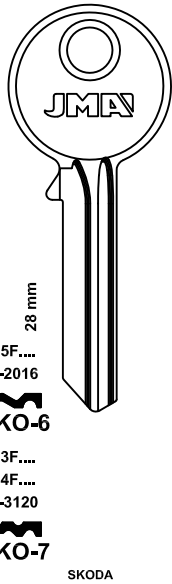

**FAICA**

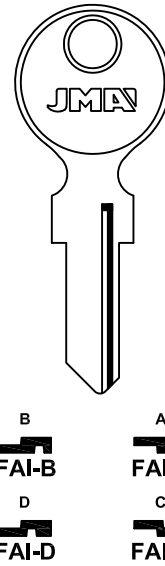

**PARA-FOR:**

- FAB (CZ)
- FAICA (E)
- FARMA (I)
- FEMSA (E)
- FIAT (I)
- FIST (I)
- FLORA (D)
- FORD (USA)

**FARMA**

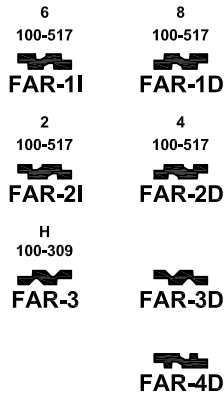
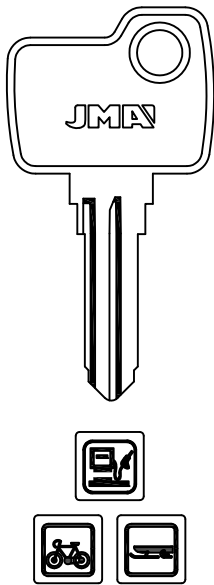

**FEMSA**

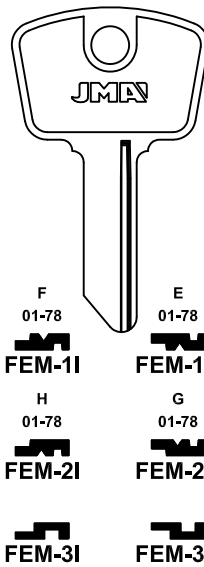

**FIAT**

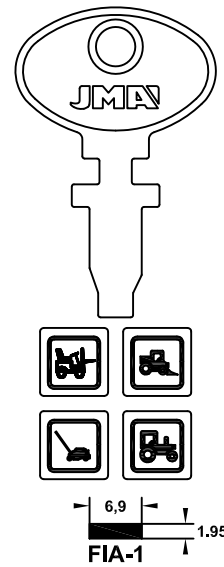

**FIAT**

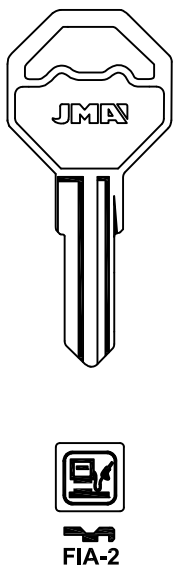

**FIST**

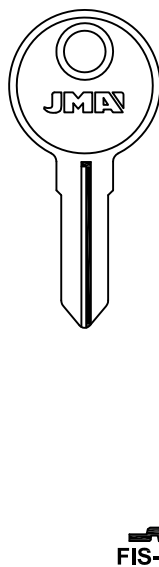

**FLORA**

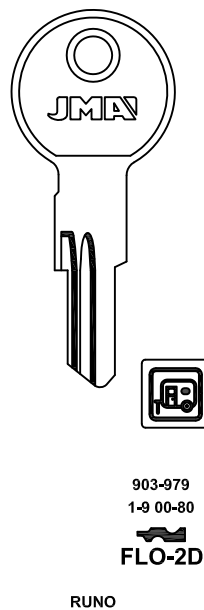

**FORD**

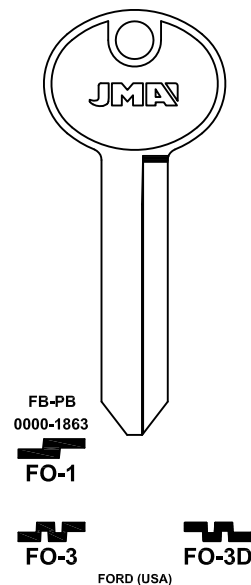



**PARA-FOR:**

FORD (USA)

**FORD**

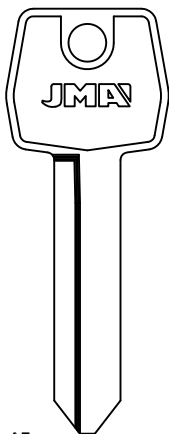

AF  
0001-2600  
FA-PA  
0000-1863

**FO-2**  
FORD (USA)-MASERATI

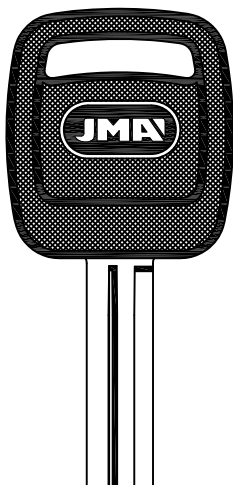

**FO-3.P**      **FO-3D.P**  
FORD (USA)

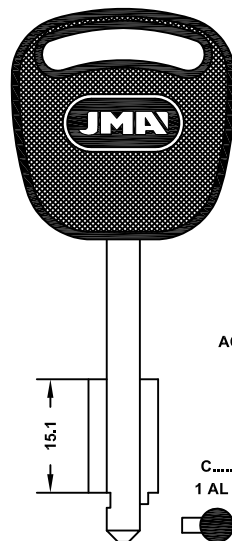

ACE.  
15.1  
C.....  
1 AL 5

**FO-4.P**  
FORD  
KOLB

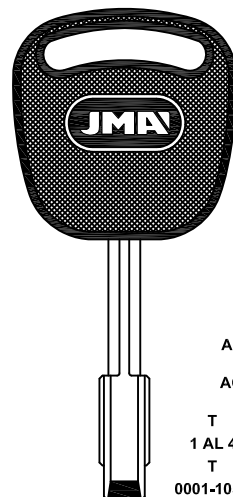

ALP.  
ACE.  
T  
1 AL 4  
T  
0001-1050

**FO-6.P**  
FORD  
HUF

**FORD**

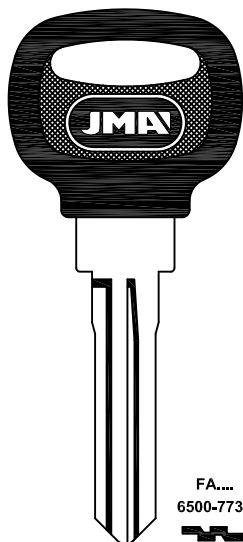

FA....  
6500-7733

**FO-7.P**  
FORD

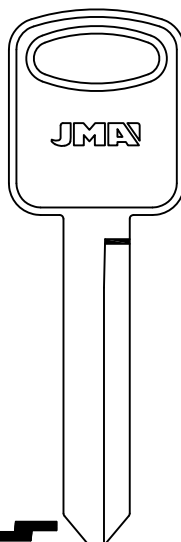

A  
101-291  
501-579  
B  
101-332  
501-602  
C  
101-344  
501-624  
D  
101-327  
501-602  
E  
101-296  
501-579

**FO-8**      **FO-8D**  
FORD

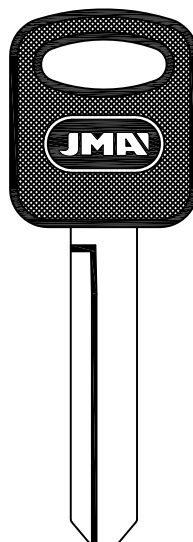

A  
101-291  
501-579  
B  
101-332  
501-602  
C  
101-344  
501-624  
D  
101-327  
501-602  
E  
101-296  
501-579

**FO-8D.P**  
FORD

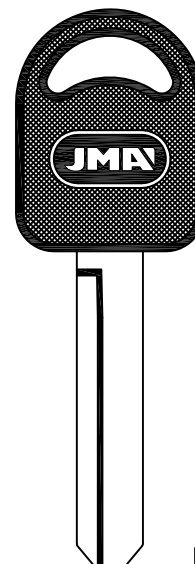

A  
101-291  
501-579  
B  
101-332  
501-602  
C  
101-344  
501-624  
D  
101-327  
501-602  
E  
101-296  
501-579

**FO-8D.P1**  
FORD-MERCURY

**FORD**

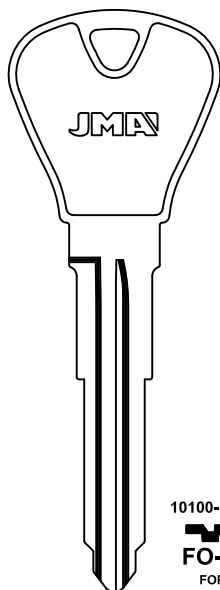

10100-12099

**FO-9D**  
FORD

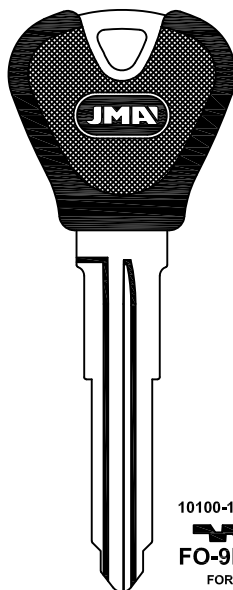

10100-12099

**FO-9D.P**  
FORD

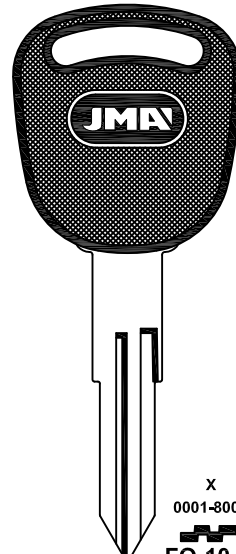

X  
0001-8000

**FO-10.P**  
FORD

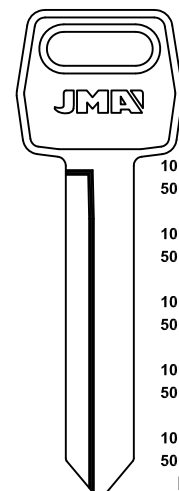

A  
101-291  
501-579  
B  
101-332  
501-602  
C  
101-344  
501-624  
D  
101-327  
501-602  
E  
101-296  
501-579  
FA  
6500-7733

**FO-11D**  
FORD



FORD

PARA-FOR:

FORD (USA)

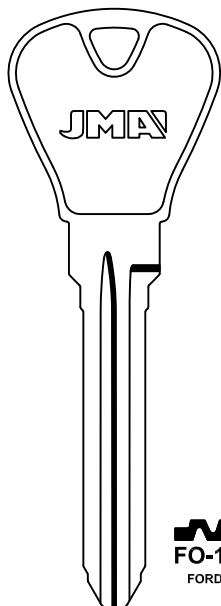

FO-12  
FORD

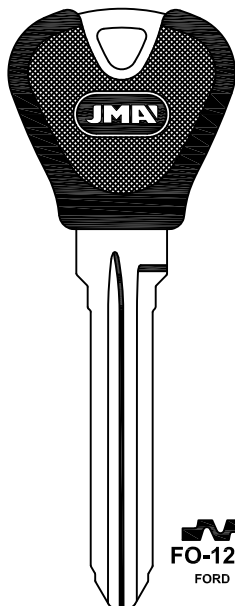

FO-12.P  
FORD

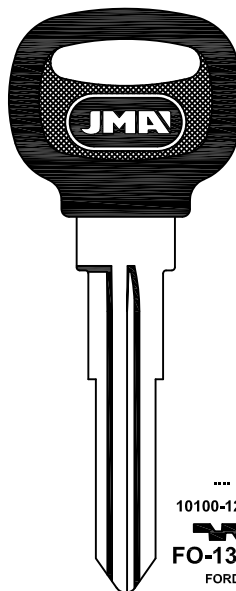

....  
10100-12099  
FO-13D.P  
FORD

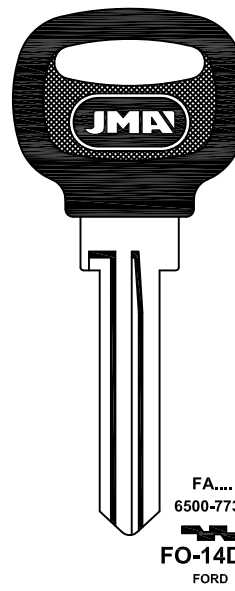

FA....  
6500-7733  
FO-14D.P  
FORD

FORD

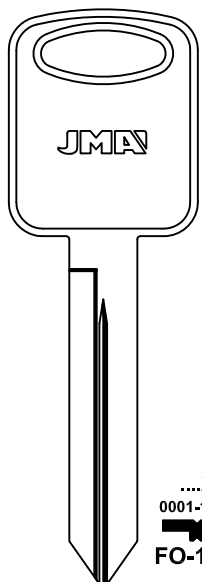

....X  
0001-1706  
FO-15D

STRATTEC

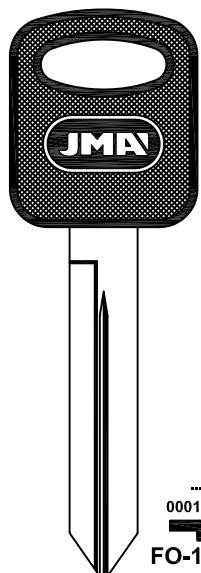

....X  
0001-1706  
FO-15D.P

STRATTEC

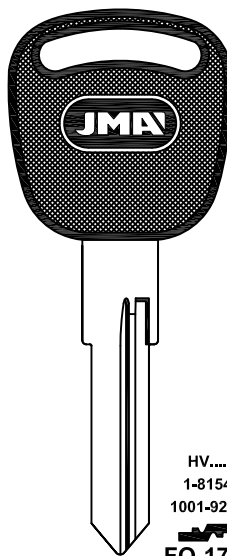

HV....  
1-8154  
1001-9282  
FO-17.P

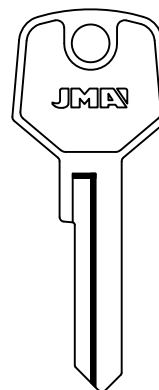

FO-18D

FORD

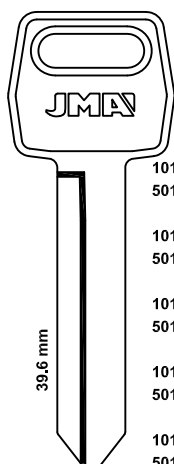

39.6 mm

- A  
101-291  
501-579
- B  
101-332  
501-602
- C  
101-344  
501-624
- D  
101-327  
501-602
- E  
101-296  
501-579
- FA  
6500-7733

FO-20D  
FORD

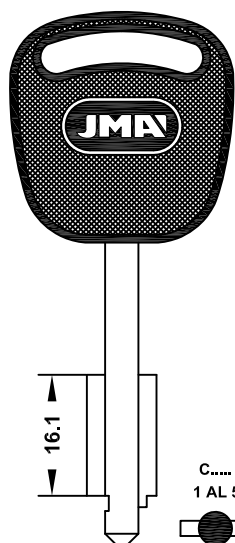

16.1

C....  
1 AL 5  
FO-22.P

FORD  
KOLB

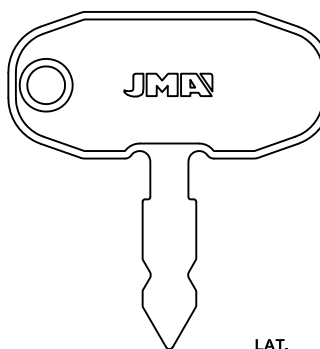

LAT.



FO-35





**PARA-FOR:**  
FORD (USA)

**FORD**

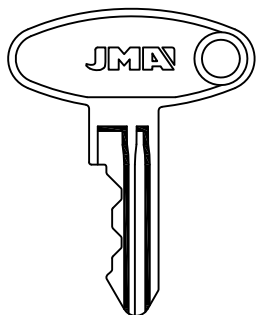

FO-36

LAT.

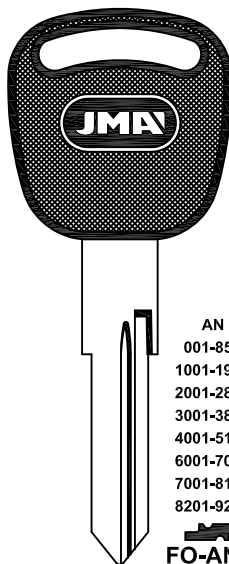

AN  
001-854  
1001-1918  
2001-2830  
3001-3890  
4001-5151  
6001-7086  
7001-8154  
8201-9282

FO-AN.P

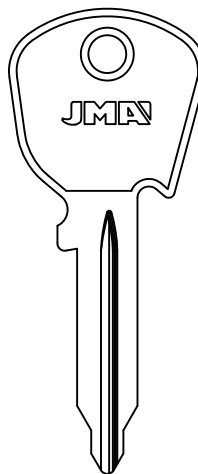

B-D-DV  
01-64

FO-D

FORD-JAGUAR-VOLKSWAGEN  
BRITAX-KOLB

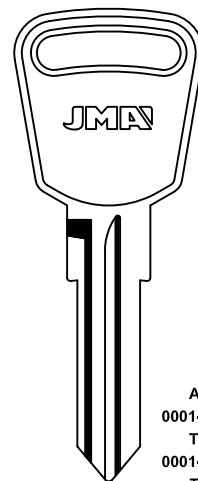

AK  
0001-1000  
TC  
0001-1000  
TX  
0001-1859

FO-E/TC

ASTON M.-FORD-JAGUAR-ROVER-YUGO  
CASI-CEM-CLAUSOR-KOLB-NEIMAN

**FORD**

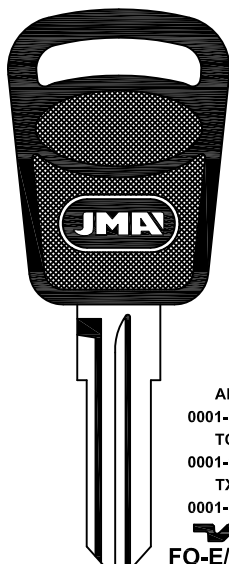

AK  
0001-1000  
TC  
0001-1000  
TX  
0001-1859

FO-E/TC.P

ASTON M.-FORD-JAGUAR-ROVER-YUGO  
CASI-CEM-CLAUSOR-KOLB-NEIMAN



FO-FH.P

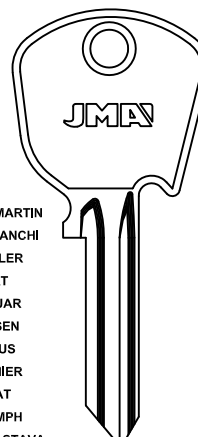

ASTON MARTIN  
AUTOBIANCHI  
DAIMLER  
FIAT  
JAGUAR  
JENSEN  
LOTUS  
PREMIER  
SEAT  
TRIUMPH  
YUGO ZASTAVA

SCANIA  
FK  
1-3040

FO-FK

ARMAN-DOM-JUGODENT-WASO

FR  
1-3040  
4001-6000

FO-FR

ASTON MARTIN  
AUTOBIANCHI  
DAIMLER  
FIAT  
JAGUAR  
JENSEN  
LOTUS  
PREMIER  
SEAT  
TRIUMPH  
YUGO ZASTAVA

SCANIA  
FK  
1-3040

FO-FK.P

ARMAN-DOM-JUGODENT-WASO

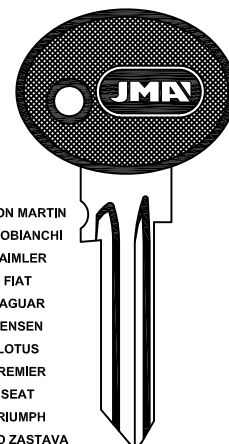

FR  
1-3040  
4001-6000

FO-FR.P

**FORD**

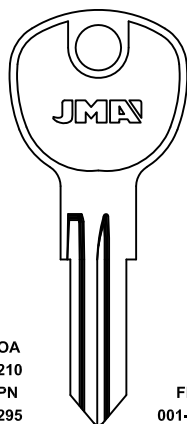

DA-OA  
001-210  
ER-PN  
101-295  
ER  
001-195  
ER  
501-695

FO-OA

DAF-EBRO-KENWORTH-VOLKSWAGEN  
CASI-HUF-YMOS

FB  
001-210  
PO  
501-695  
PO  
101-295

FO-PN

OL  
001-210  
07R  
001-195  
7OR  
001-210

FO-OL

CASI-YMOS

OB...  
1-210

VO-7

NSU

07L  
001-195  
7OL  
001-210  
OR  
001-210

FO-OR

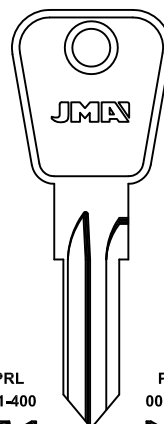

PRL  
001-400

FO-PRL

XL  
001-195

FO-XL

FORD  
CASI-YMOS

PRR  
001-400

FO-PRR

XR  
001-195

FO-XR

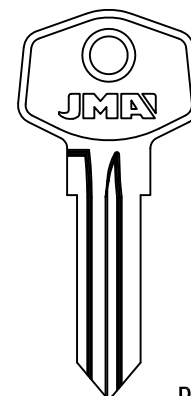

DM  
300-400  
TC-AK  
0001-1000  
TX  
0001-1859

FO-TC

DAF-DAIMLER-FORD-JAGUAR  
CASI-CEM-KOLB



# FORD

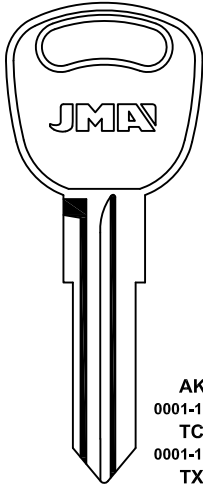

AK  
0001-1000  
TC  
0001-1000  
TX  
0001-1859



FORD

CASI-CEM-CLAUSOR-KOLB-NEIMAN

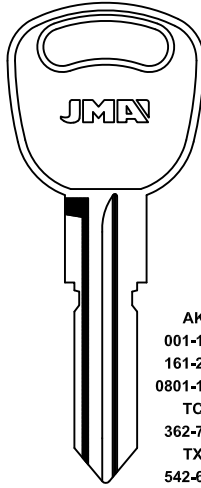

AK  
001-100  
161-250  
0801-1000  
TC  
362-728  
TX  
542-671  
1300-1601



FORD

FO-TX1

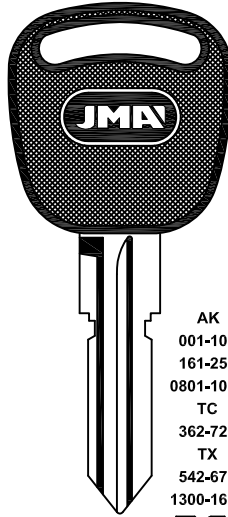

AK  
001-100  
161-250  
0801-1000  
TC  
362-728  
TX  
542-671  
1300-1601



FORD

FO-TX1.P

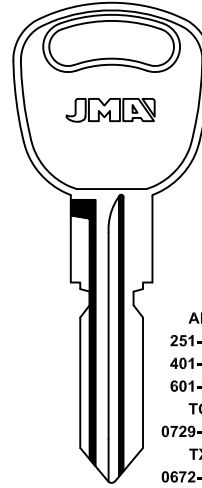

AK  
251-300  
401-500  
601-700  
TC  
0729-1000  
TX  
0672-1000  
1602-1859



FORD

FO-TX2

# PARA-FOR:

FORD (USA)

GAS (RA)

G.M. (USA)

# FORD

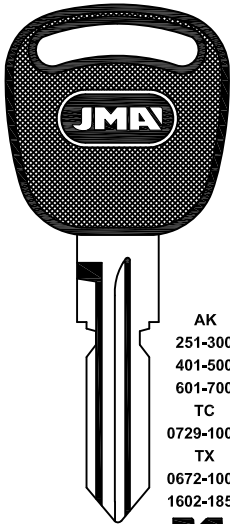

AK  
251-300  
401-500  
601-700  
TC  
0729-1000  
TX  
0672-1000  
1602-1859



FORD

CASI-CEM-CLAUSOR-KOLB-NEIMAN

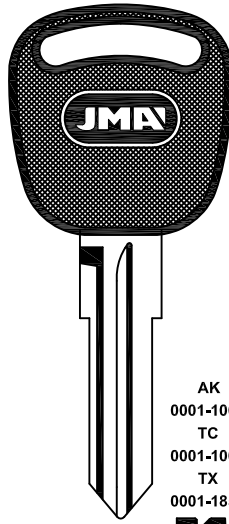

AK  
0001-1000  
TC  
0001-1000  
TX  
0001-1859



FORD

FO-TX.P

# GAS

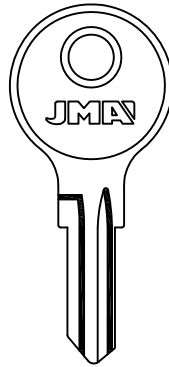

GAS-1



GAS-1D

# G.M.

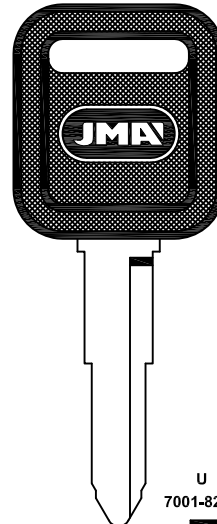

U  
7001-8200



G.M.  
BRIGGS STRATTON

# GENERAL MOTORS

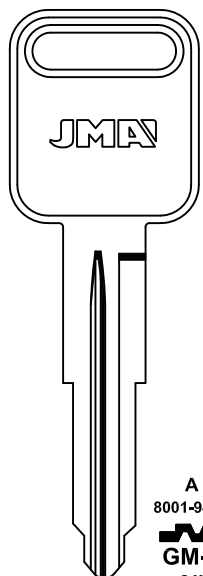

A  
8001-9400



G.M.

BRIGGS STRATTON

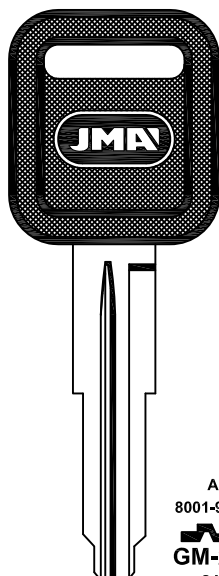

A  
8001-9400



G.M.

BRIGGS STRATTON

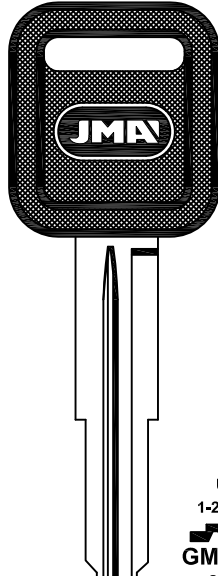

U  
1-2000



G.M.

BRIGGS S.

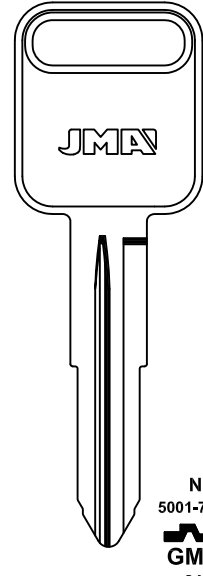

N  
5001-7000



G.M.

BRIGGS STRATTON



PARA-FOR:

G.M. (USA)

### GENERAL MOTORS



N  
5001-7000  
  
GM-4.P  
G.M.

BRIGGS STRATTON



N  
5001-7000  
  
GM-4.P1  
G.M.

BRIGGS STRATTON

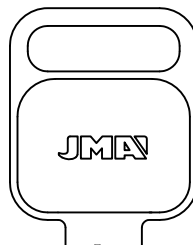

U  
1-2000  
  
GM-5  
G.M.

BRIGGS S.



U  
1-2000  
  
GM-5.P  
G.M.

BRIGGS S.

### GENERAL MOTORS



A  
000-999  
  
GM-6

E  
000-999  
  
GM-8

G.M.  
BRIGGS STRATTON



A  
000-999  
  
GM-6.P

E  
000-999  
  
GM-8.P

G.M.  
BRIGGS STRATTON

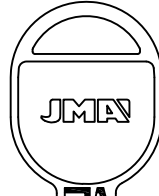

B  
000-999  
  
GM-10

H  
000-999  
  
GM-12

G.M.  
BRIGGS STRATTON



B  
000-999  
  
GM-10.P

H  
000-999  
  
GM-12.P

G.M.  
BRIGGS STRATTON

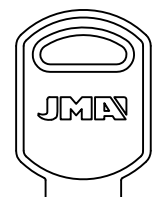

....A00-7N45  
  
GM-14

G.M.  
BRIGGS STRATTON



....A00-7N45  
  
GM-14.P

G.M.  
BRIGGS STRATTON

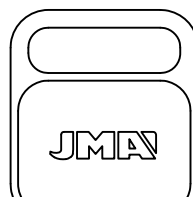

D....  
4001-6000  
  
GM-15D  
BRIGGS S.



D....  
4001-6000  
  
GM-15D.P  
ISUZU  
BRIGGS S.



## GENERAL MOTORS

PARA-FOR:  
G.M. (USA)

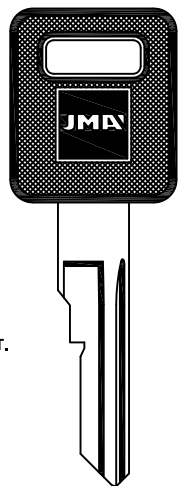

LAT.

A  
..A..0.00-9.99  
..B..0.00-9.99  
..V..0.00-9.99  
..V..0.00-9.99  
..W..0.00-9.99  
..W..0.00-9.99



**GM-16.P**

E  
..J..0.00-9.99  
..K..0.00-9.99



**GM-18.P**

G.M.

BRIGGS STRATTON

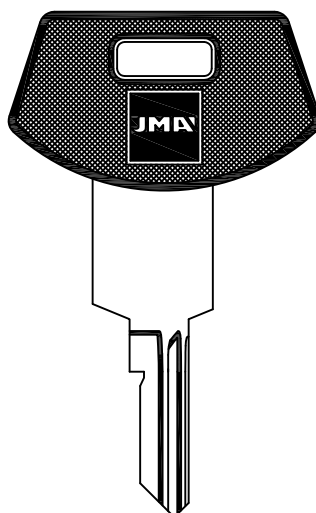

LAT.

C  
..A..0.00-9.99  
..B..0.00-9.99  
..N..0.00-9.99  
..N..0.00-9.99  
..P..0.00-9.99  
..P..0.00-9.99



**GM-17.P**

C

..A..0.00-9.99  
..B..0.00-9.99  
..N..0.00-9.99  
..N..0.00-9.99  
..P..0.00-9.99  
..P..0.00-9.99



**GM-19.P**

E

..J..0.00-9.99  
..K..0.00-9.99



**GM-20.P**

G.M.

BRIGGS STRATTON

## GENERAL MOTORS

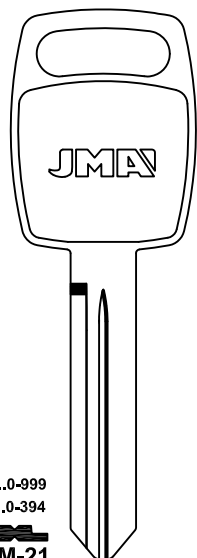

LAT.

R...0-999  
T...0-394



**GM-21**

BRIGGS & STRATTON



LAT.

R...0-999  
T...0-394



**GM-21.P**

BRIGGS & STRATTON

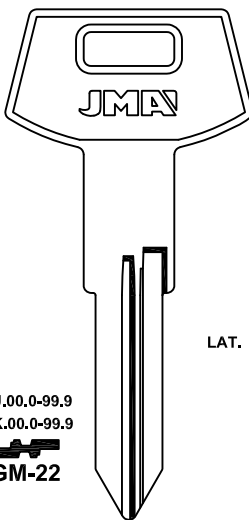

LAT.

..J..0.00-9.99  
..K..0.00-9.99



**GM-22**



**GM-23**

G.M.

BRIGGS STRATTON

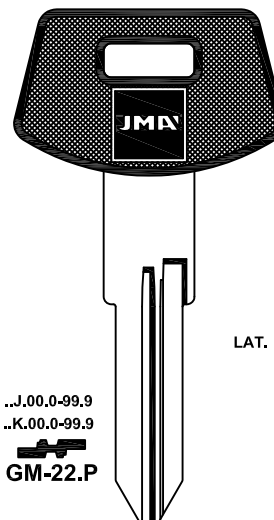

LAT.

..J..0.00-9.99  
..K..0.00-9.99



**GM-22.P**



**GM-23.P**

G.M.

BRIGGS STRATTON

## GENERAL MOTORS

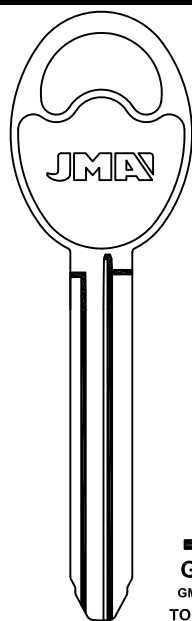

LAT.

1....  
1-5000



**GM-24**

GM-TOYOTA  
TOKAJ-RIKA

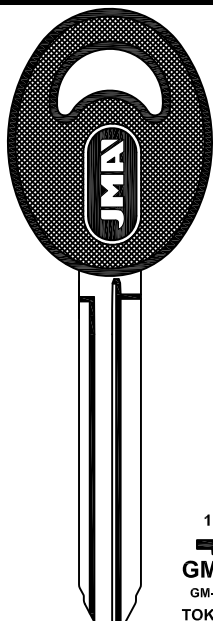

LAT.

1....  
1-5000



**GM-24.P**

GM-TOYOTA  
TOKAJ-RIKA

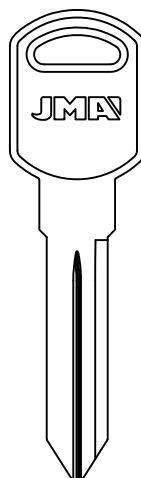

G.M.

BRIGGS STRATTON

....A00-7N45



**GM-25**

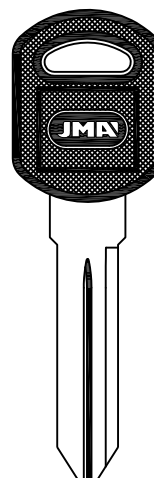

G.M.

BRIGGS STRATTON

....A00-7N45



**GM-25.P**



**PARA-FOR:**

G.M. (USA)

GEWU (D)

GHE (D)

**GENERAL MOTORS**

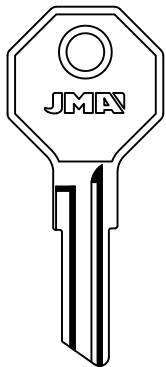

**GM-26**

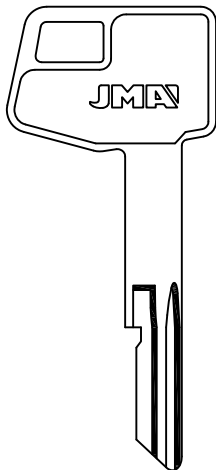

0000-1999  
**GM-42**

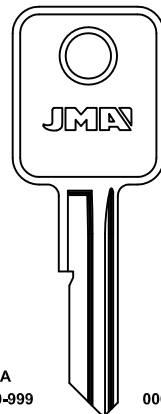

A  
000-999  
**GM-A**

E  
000-999  
**GM-E**



C  
000-999  
**GM-C**

J  
000-999  
**GM-J**

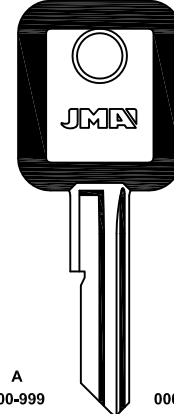

A  
000-999  
**GM-A.P**

E  
000-999  
**GM-E.P**



C  
000-999  
**GM-C.P**

J  
000-999  
**GM-J.P**

G.M.  
BRIGGS STRATTON

G.M.  
BRIGGS STRATTON

**GENERAL MOTORS**

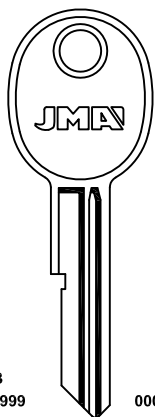

B  
000-999  
**GM-B**

H  
000-999  
**GM-H**

G.M.  
BRIGGS STRATTON

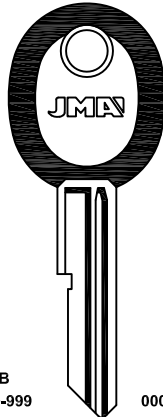

D  
000-999  
**GM-D**

K  
000-999  
**GM-K**

G.M.  
BRIGGS STRATTON

**GEWU**

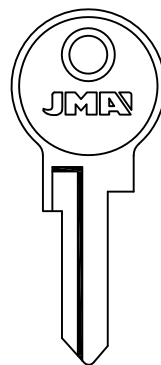

**GW-1D**

ZUNDAPP

**GHE**

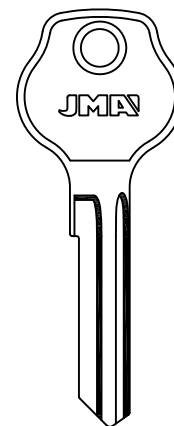

**GH-1**

**GHE**

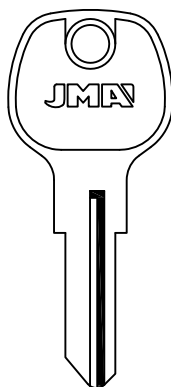

GY  
25-90  
**GH-2**

PEROHAUS-POS-WECO

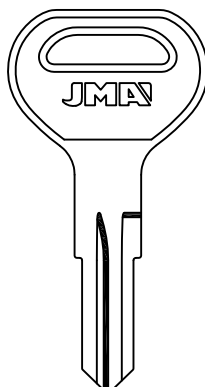

LS 378-616  
**GH-3**

KASSBOHRER

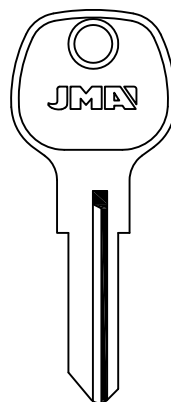

GX  
091-320  
**GH-GX**

PEROHAUS-POS-WECO



HX  
091-320  
**GH-HX**

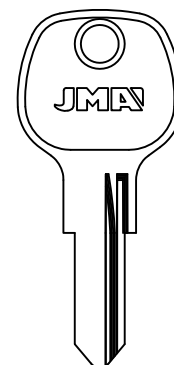

PS  
139  
**GH-PS**





# GIOBERT

PARA-FOR:

GIOBERT (I)

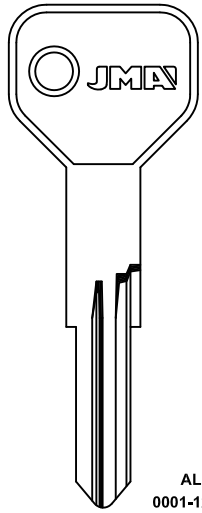

AL  
0001-1274



AF-13

ALFA ROMEO  
YMOS

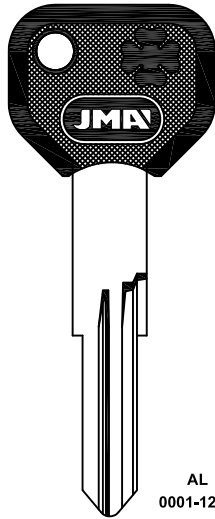

AL  
0001-1274



AF-13.P

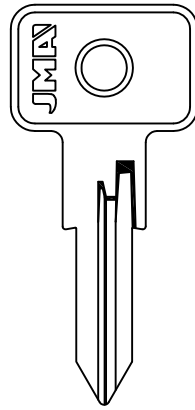

K-H  
7001-8092



AF-14

ARMAN-CLAUSOR

FIST-M.MARELLI-NEIMAN-SIPEA

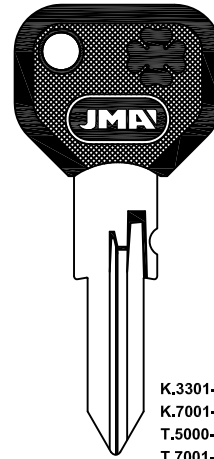

K-H  
7001-8092



AF-14.P

K.3301-4886  
K.7001-8092  
T.5000-6027  
T.7001-8092  
S.0501-3278  
H.7001-8092



FI-6I.P4

# GIOBERT

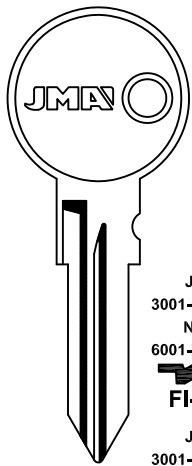

J  
3001-6732  
N  
6001-7000



FI-1

J  
3001-6732  
N  
6001-7000



FI-10

AUTOBIANCHI-FIAT-LANCIA  
RAYTON FISSORE-STREYR PUCH  
CAGIVA-GILERA-PIAGGIO VESPA

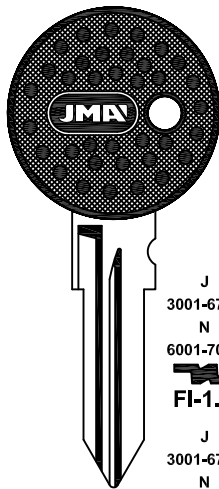

J  
3001-6732  
N  
6001-7000



FI-1.P

J  
3001-6732  
N  
6001-7000



FI-10.P

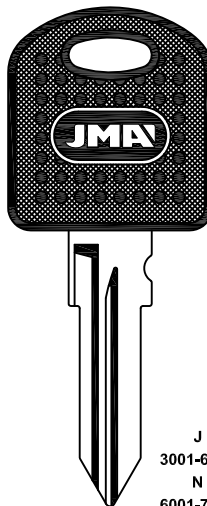

J  
3001-6732  
N  
6001-7000



FI-1.P8

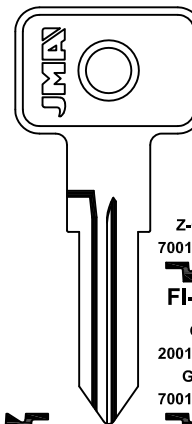

Z-GR  
7001-9956



FI-2D

G  
2001-4530

G-Z  
7001-9956



FI-3D

G  
7001-9956



FI-12

A. ROMEO-AUTOBIANCHI-CITROEN-FIAT  
INNOCENTI-LANCIA-PEUGEOT-SEAT  
YUGO ZASTAVA-FIAT IVECO

# GIOBERT

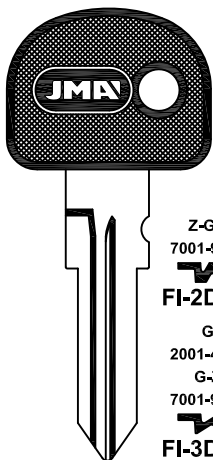

Z-GR  
7001-9956



FI-2D.P3

G  
2001-4530

G-Z  
7001-9956

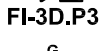

FI-3D.P3

G  
7001-9956

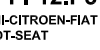

FI-12.P3

A. ROMEO-AUTOBIANCHI-CITROEN-FIAT  
LANCIA-PEUGEOT-SEAT

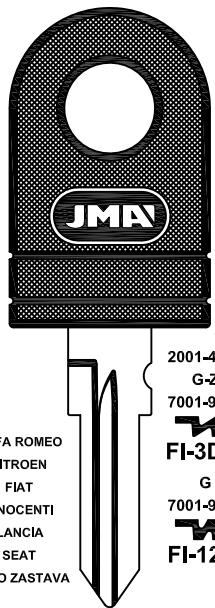

G  
2001-4530  
G-Z  
7001-9956



FI-3D.P

G  
7001-9956



FI-12.P

ALFA ROMEO  
CITROEN  
FIAT  
INNOCENTI  
LANCIA  
SEAT  
YUGO ZASTAVA



G  
2001-4530  
G-Z  
7001-9956



FI-3D.P1

G  
7001-9956



FI-12.P1

ALFA ROMEO  
FIAT IVECO

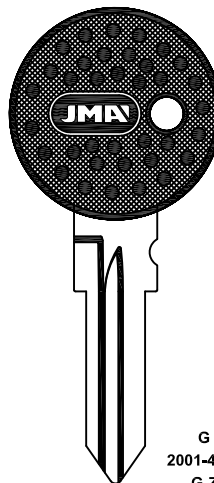

G  
2001-4530  
G-Z  
7001-9956



FI-3D.P2

FIAT



PARA-FOR:

GIOBERT (I)

GIOBERT

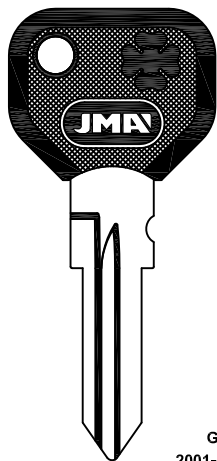

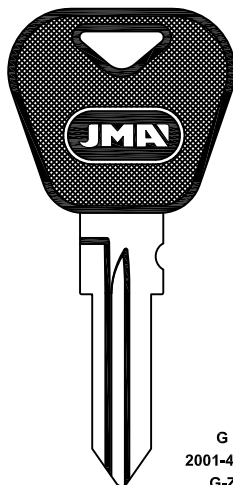

G  
2001-4530  
G-Z  
7001-9956  
  
**FI-3D.P4**  
ALFA ROMEO

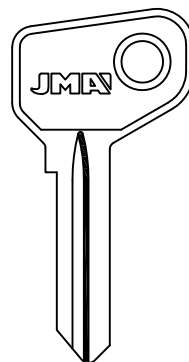

G  
2001-4530  
G-Z  
7001-9956  
  
**FI-3D.P5**  
INNOCENTI-YUGO ZASTAVA



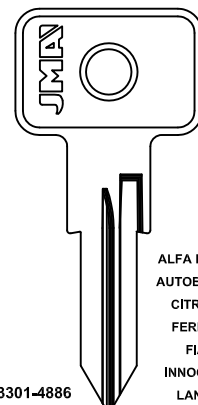

  
**FI-4D**  
  
**FI-5I**  
OM IVECO-FIAT IVECO  
IACAM

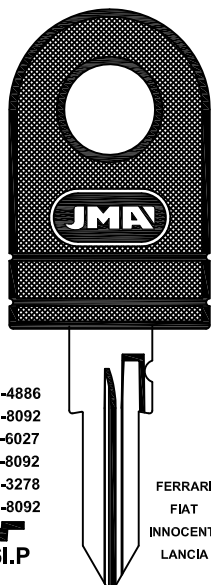

K 3301-4886  
K 7001-8092  
T 5000-6027  
T 7001-8092  
S 0501-3278  
H 7001-8092  
  
**FI-6I**  
ALFA ROMEO  
AUTOBIANCHI  
CITROEN  
FERRARI  
FIAT  
INNOCENTI  
LANCIA  
PEUGEOT  
YUGO ZASTAVA  
CAGIVA  
DUCATI  
FANTIC MOTOR  
GARELLI  
GILERA

GIOBERT



K 3301-4886  
K 7001-8092  
T 5000-6027  
T 7001-8092  
S 0501-3278  
H 7001-8092  
  
**FI-6I.P**  
FERRARI  
FIAT  
INNOCENTI  
LANCIA



K 3301-4886  
K 7001-8092  
T 5000-6027  
T 7001-8092  
S 0501-3278  
H 7001-8092  
  
**FI-6I.P1**  
A. ROMEO  
FIAT IVECO

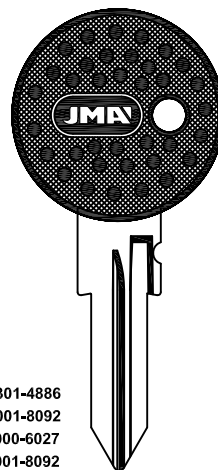

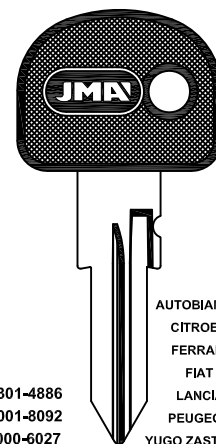

K 3301-4886  
K 7001-8092  
T 5000-6027  
T 7001-8092  
S 0501-3278  
H 7001-8092  
  
**FI-6I.P2**  
FERRARI  
FIAT  
CAGIVA

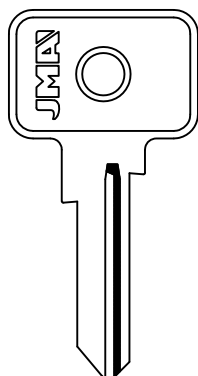

K 3301-4886  
K 7001-8092  
T 5000-6027  
T 7001-8092  
S 0501-3278  
H 7001-8092  
  
**FI-6I.P3**  
AUTOBIANCHI  
CITROEN  
FERRARI  
FIAT  
LANCIA  
PEUGEOT  
YUGO ZASTAVA  
CAGIVA  
DUCATI  
FANTIC MOTOR  
GARELLI  
GILERA

GIOBERT



X  
3301-4886  
  
**FI-7I**  
FIAT  
NEIMAN-SIPEA

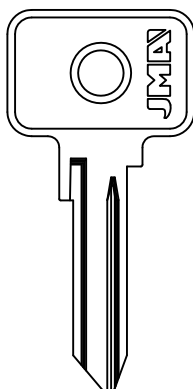

Y  
7001-9956  
  
**FI-8I**  
AUTOBIANCHI-FIAT-SEAT  
ARMAN

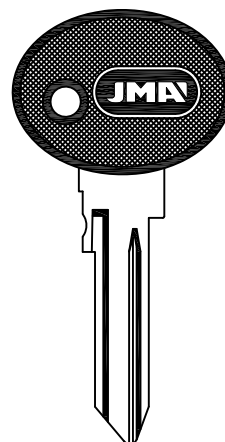

Y  
7001-9956  
  
**FI-8I.P**  
AUTOBIANCHI-FIAT-SEAT  
ARMAN

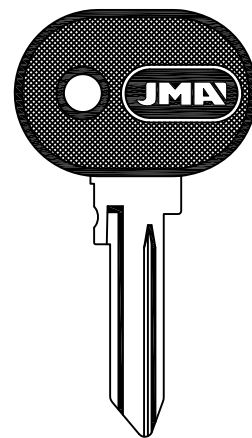

Y  
7001-9956  
  
**FI-8I.P1**  
FIAT-FIAT IVECO  
ARMAN



## GIOBERT

PARA-FOR:

GIOBERT (I)

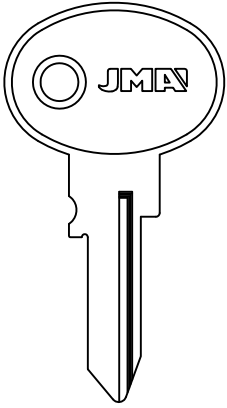

M  
0001-1050  
  
FI-9I

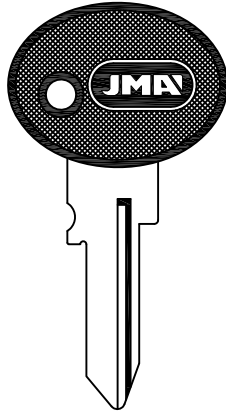

M  
0001-1050  
  
FI-9I.P

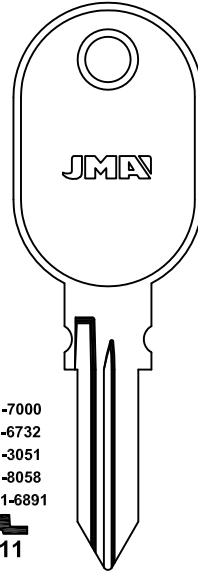

N 6001-7000  
J 3001-6732  
V 0001-3051  
V 5001-8058  
AB 6001-6891  
  
FI-11

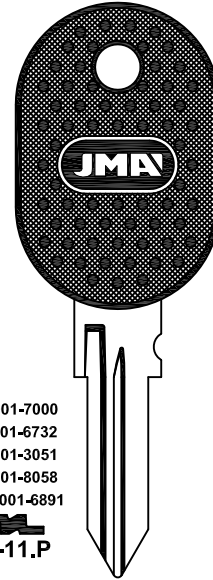

N 6001-7000  
J 3001-6732  
V 0001-3051  
V 5001-8058  
AB 6001-6891  
  
FI-11.P

ALFA ROMEO-AUTOBIANCHI-FIAT-LANCIA  
OM IVECO-SEAT-STEYR PUCH

AUTOBIANCHI-FIAT-INNOCENTI-LANCIA  
RAYTON FISSORE-STEYR PUCH-APRILIA

## GIOBERT

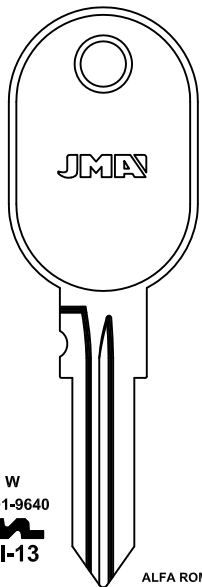

W  
0001-9640  
  
FI-13

ALFA ROMEO-FIAT-LANCIA

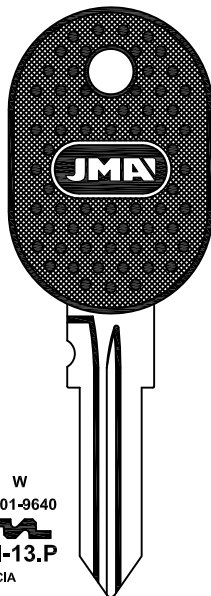

W  
0001-9640  
  
FI-13.P

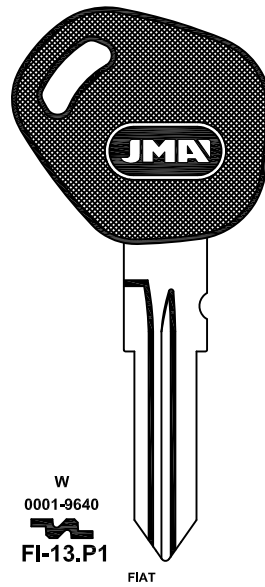

W  
0001-9640  
  
FI-13.P1

FIAT

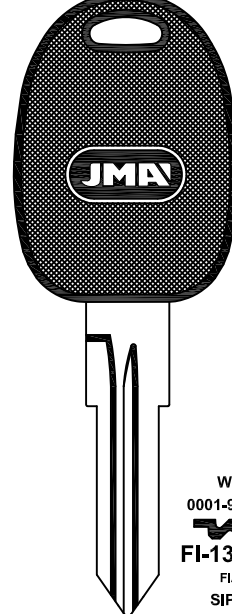

W  
0001-9640  
  
FI-13.P7  
FIAT  
SIPEA

## GIOBERT

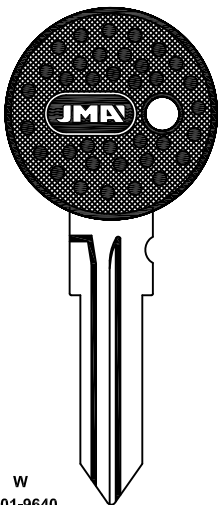

W  
0001-9640  
  
FI-14.P

ALFA ROMEO-FIAT-LANCIA

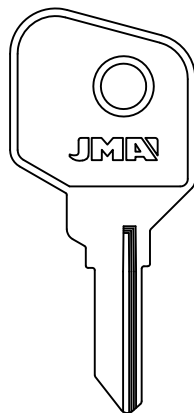

FI-15

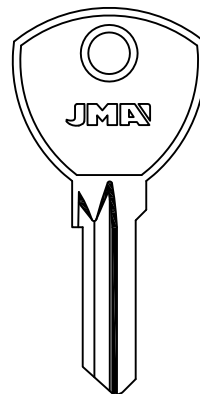

GIOB-2I

LANCIA-MASERATI



GIOB-1D

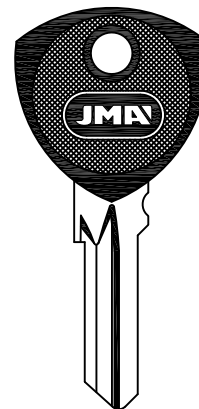

GIOB-2I.P

LANCIA-MASERATI



GIOB-1D.P

**JMA**<sup>®</sup>

Copyright by Alejandro Altuna S.A. 2014









ATENCIÓN: Concerniente a las marcas y denominaciones comerciales ver nota en índice.  
ATTENTION: Concerning the marks and commercial denominations see note in index.  
ATTENTION: Concernant les marques et dénominations commerciales voir la note dans l'index.  
ACHTUNG: Beziehen auf die marke und handelsname sehen sie die notiz im index.

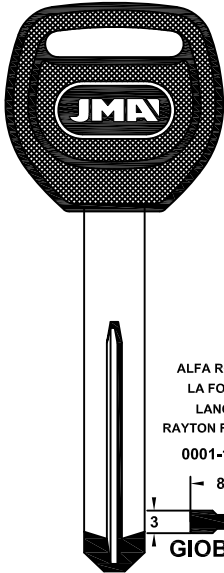

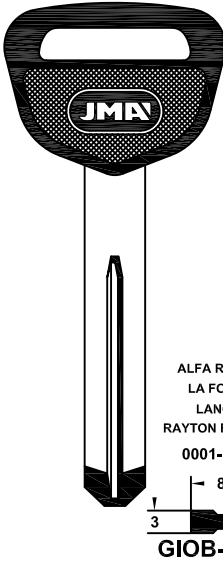
**PARA-FOR:**

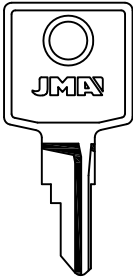
- GIOBERT (I)
- HAMA (D)
- HARLEY DAV. (USA)
- HONDA (J)

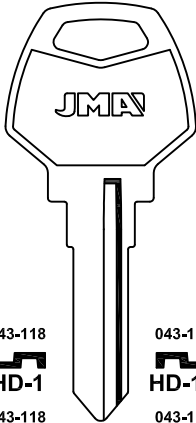
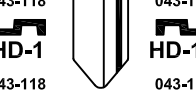
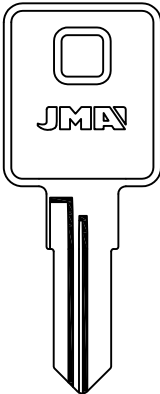
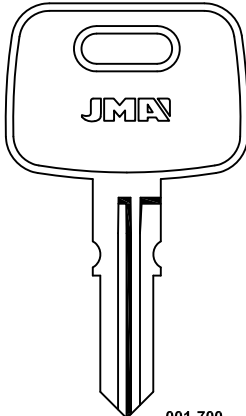
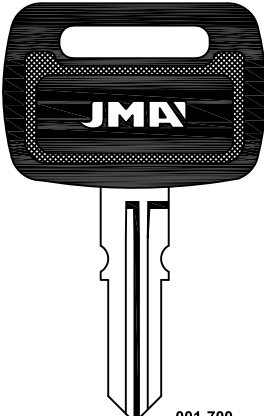
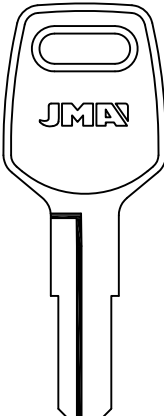
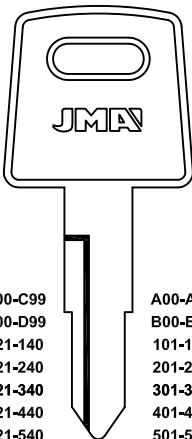
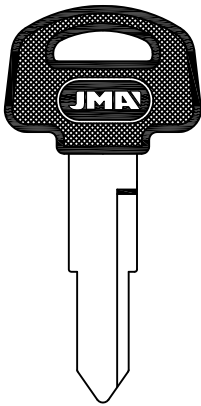
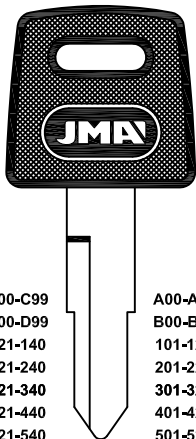
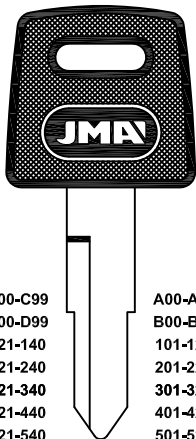
GIOBERT		HAMA		HARLEY DAV.				
 <p>ALP. ALFA ROMEO LA FORZA LANCIA RAYTON FISSORE 0001-1530</p>  <p>GIOB-3.P SAFE</p>	 <p>ALP. ALFA ROMEO LA FORZA LANCIA RAYTON FISSORE 0001-1530</p>  <p>GIOB-3.P2 SAFE</p>	  <p>751-762 HA-1I</p> <p>FORD BLAU</p> <p>778-789 HA-1D</p>	 <p>043-118 HD-1</p> <p>043-118 HD-2</p> <p>043-118 HD-3</p> <p>HARLEY DAVIDSON</p>	 <p>043-118 HD-1D</p> <p>043-118 HD-2D</p> <p>043-118 HD-3D</p> <p>HARLEY DAVIDSON</p>	 <p>HD-4D</p>	 <p>001-700 HOND-1</p> <p>001-700 HOND-2</p> <p>HONDA-TRIUMPH</p>	 <p>001-700 HOND-1.P</p> <p>001-700 HOND-2.P</p> <p>HONDA-TRIUMPH</p>	 <p>1 AL 4</p> <p>HOND-3I HOND-3D</p> <p>HONDA</p>
HONDA								
 <p>C00-C99 D00-D99 121-140 221-240 321-340 421-440 521-540 621-640 721-740 821-840</p> <p>HOND-4I</p>	 <p>A00-A99 B00-B99 101-120 201-220 301-320 401-420 501-520 601-620 701-720 801-820</p> <p>HOND-25.P2</p> <p>HOND-30.P2</p> <p>HONDA</p>	<p>A00-A99 B00-B99 101-120 201-220 301-320 401-420 501-520 601-620 701-720 801-820</p> <p>HOND-4D.P2</p> <p>HOND-30D.P2</p>	 <p>C00-C99 D00-D99 121-140 221-240 321-340 421-440 521-540 621-640 721-740 821-840</p> <p>HOND-4I.P</p>	 <p>A00-A99 B00-B99 101-120 201-220 301-320 401-420 501-520 601-620 701-720 801-820</p> <p>HOND-4D.P</p> <p>HONDA</p>				



# HONDA

PARA-FOR:  
HONDA (J)

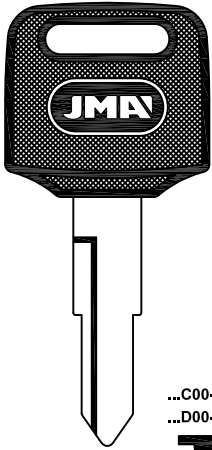

...C00-C99  
...D00-D99  
**HOND-4I.P1**

...A00-A99  
...B00-B99  
**HOND-4D.P1**

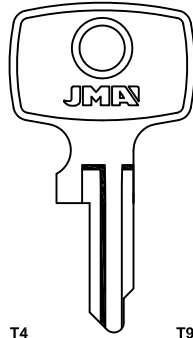

T4  
**HOND-5I**

T9  
**HOND-5D**

T1  
**HOND-6I**

2 AL 9  
3 AL 6  
T6  
**HOND-6D**

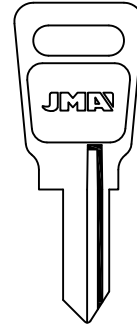

**HOND-18.P**  
HONDA

**HOND-18D.P**

T3  
**HOND-7I**  
HONDA

T8  
**HOND-7D**  
HONDA

**HOND-8I**  
HONDA

**HOND-8D**  
HONDA

# HONDA

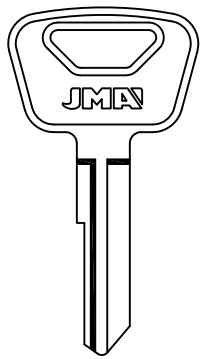

**HOND-9I**  
HONDA

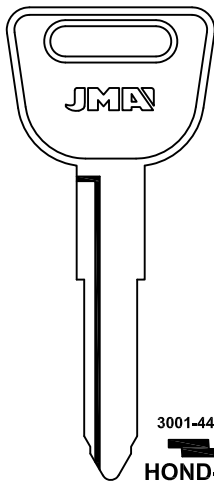

3001-4481  
**HOND-10**

3001-4481  
**HOND-11**  
ACURA-HONDA-ROVER

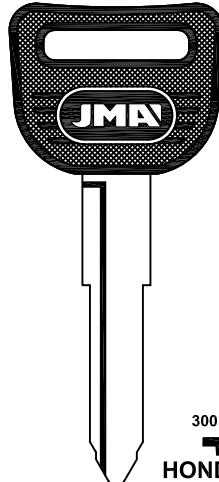

3001-4481  
**HOND-10.P**

3001-4481  
**HOND-11.P**  
ACURA-HONDA-ROVER

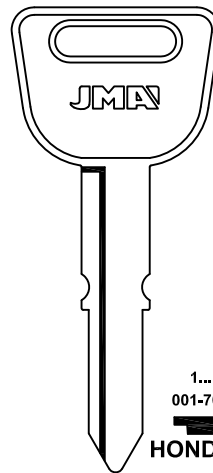

1...  
001-700  
**HOND-12**

2...  
001-700  
**HOND-13**  
HONDA

# HONDA

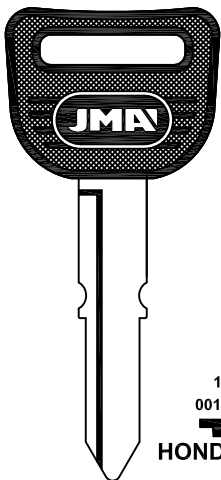

1...  
001-700  
**HOND-12.P**

2...  
001-700  
**HOND-13.P**  
HONDA

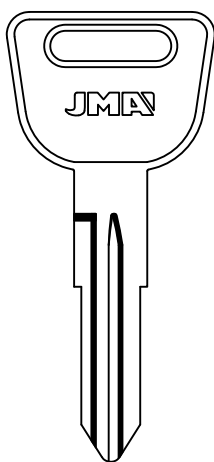

5001-8442  
**HOND-14**  
HONDA

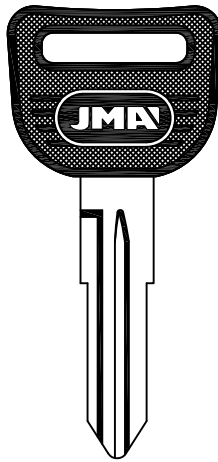

5001-8442  
**HOND-14.P**  
HONDA

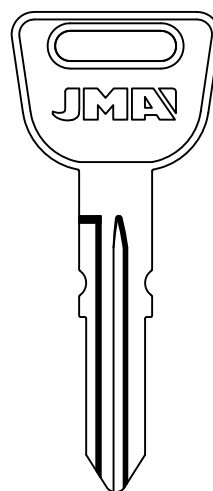

5001-8442  
**HOND-15**  
ACURA-HONDA



PARA-FOR:

HONDA (J)

HONDA

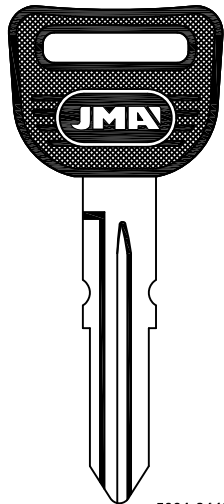

5001-8442

HOND-15.P

ACURA-HONDA

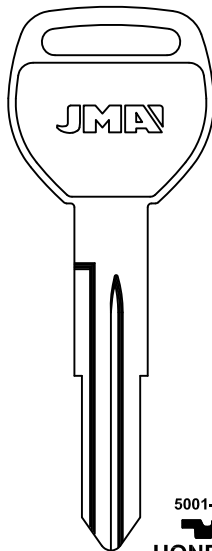

5001-8442

HOND-16D

ACURA-HONDA

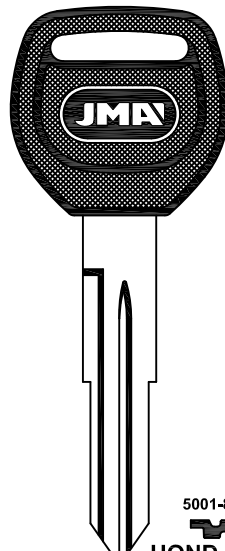

5001-8442

HOND-16D.P

ACURA-HONDA

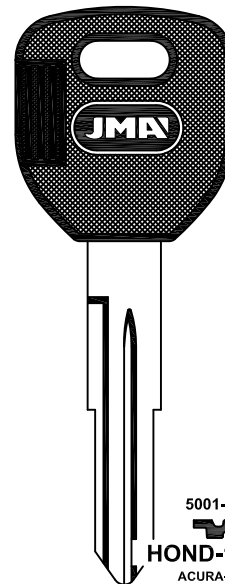

5001-8442

HOND-16D.P1

ACURA-HONDA

HONDA

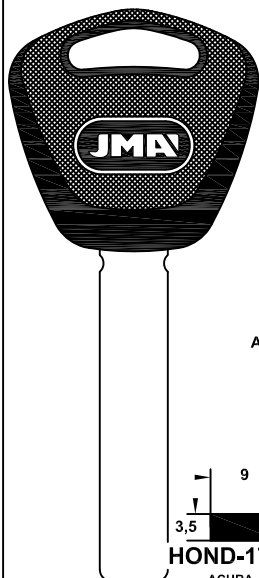

ALP.

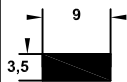

HOND-17.P

ACURA

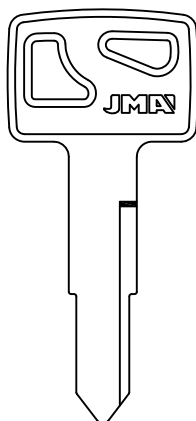

...A00-A99  
...B00-B99

HOND-19

HONDA

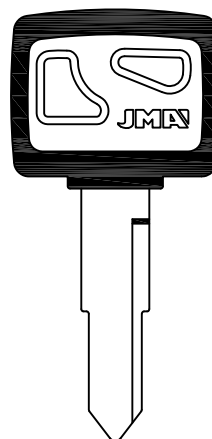

...A00-A99  
...B00-B99

HOND-19.P

HONDA

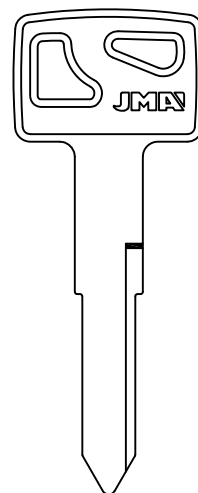

.....1 AL 3

HOND-20

HONDA

HONDA

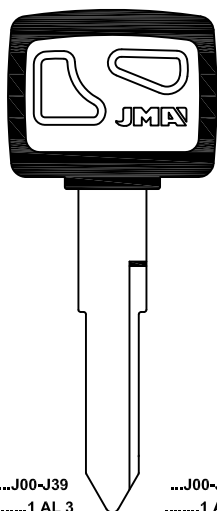

...J00-J39

.....1 AL 3

HOND-20.P

HONDA

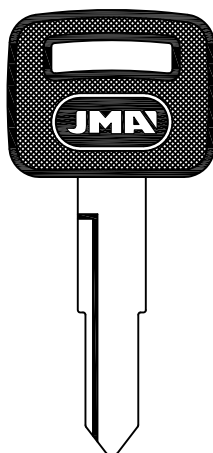

HOND-22D.P

HONDA

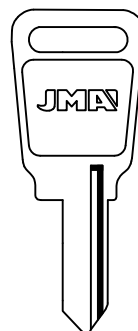

HOND-23

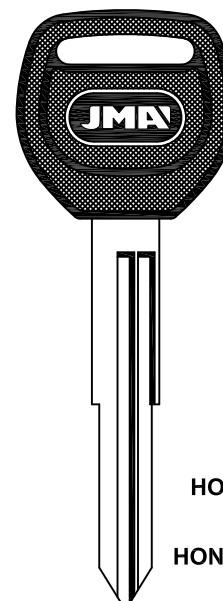

HOND-24.P

HOND-24D.P



## HONDA

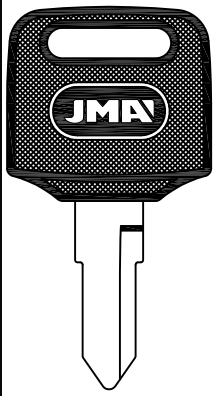

HOND-26.P1

HOND-26D.P1

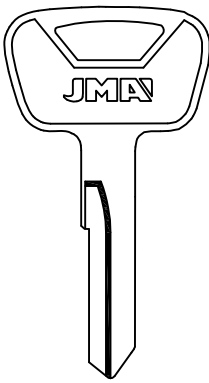

HOND-27D

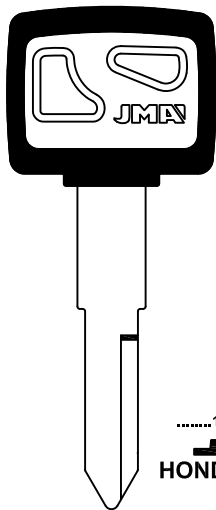

.....1 AL 3  
HOND-28.P

HOND-28D.P  
HONDA

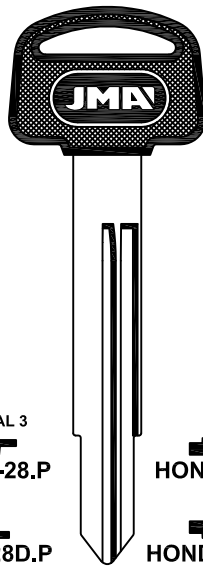

HOND-29.P

HOND-29D.P

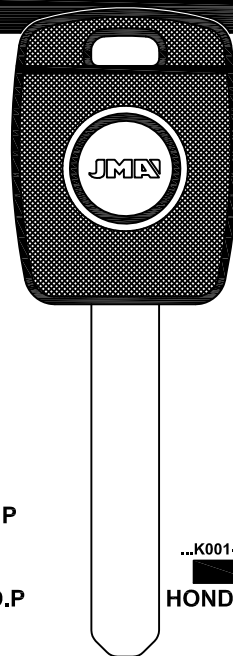

ALP.

...K001-N718  
HOND-31.P

**PARA-FOR:**  
HONDA (J)  
HUDSON (USA)  
HUF (D)

## HONDA

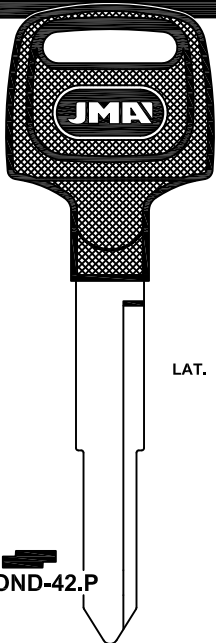

HOND-42.P

LAT.

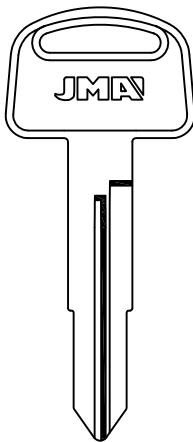

A..00-99  
HOND-43

HOND-43D

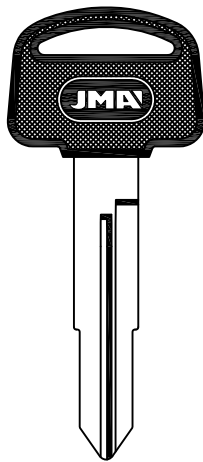

A..00-99  
HOND-43.P

HOND-43D.P

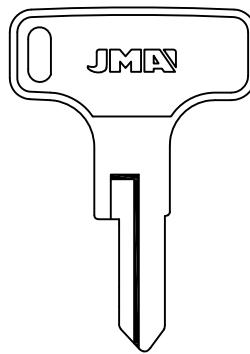

30B-34A  
H....0-7-8-9  
HOND-49

20B-24A  
H....0-4-5-6  
HOND-45D

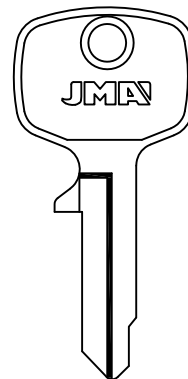

HOND-46D

## HUDSON

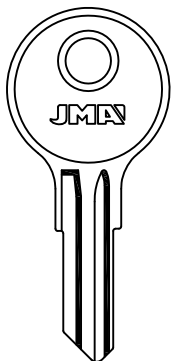

A....201-1050  
C...500-699  
H....601-1100  
HM....201-1050

HUD-1



HUD-1D

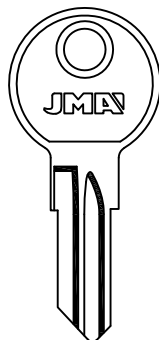

HUD-2D

## HUF

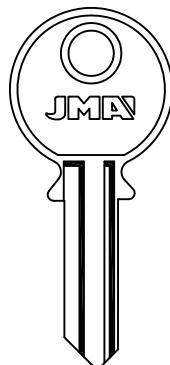

48-I

48-D

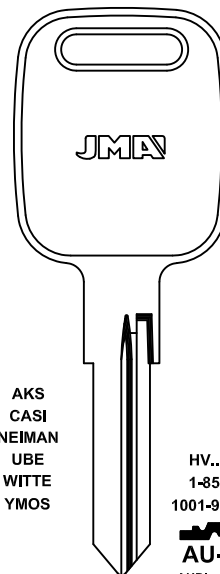

AKS  
CASI  
NEIMAN  
UBE  
WITTE  
YMOS

HV....  
1-854  
1001-9282

AU-1

AUDI  
VOLKSWAGEN-SCANIA

**JMA**<sup>®</sup>

Copyright by Alejandro Altuna S.A. 2014



ATENCIÓN: Concerniente a las marcas y denominaciones comerciales ver nota en índice.  
ATTENTION: Concerning the marks and commercial denominations see note in index.  
ATTENTION: Concernant les marques et dénominations commerciales voir la note dans l'index.  
ACHTUNG: Beziehen auf die marke und handelsname sehen sie die notiz im index.

PARA-FOR:

HUF (D)

HUF

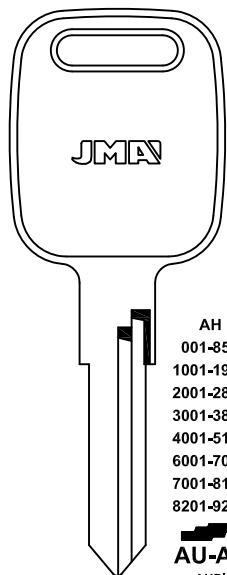

AH  
001-854  
1001-1918  
2001-2830  
3001-3890  
4001-5151  
6001-7086  
7001-8154  
8201-9282

**AU-AH**  
AUDI

AKS-CASI-UBE-WITTE

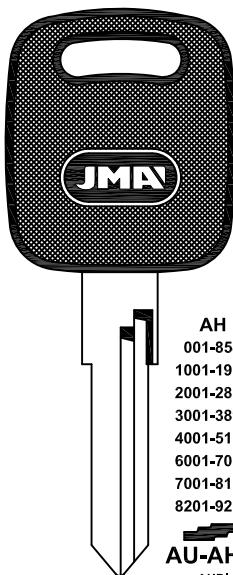

AH  
001-854  
1001-1918  
2001-2830  
3001-3890  
4001-5151  
6001-7086  
7001-8154  
8201-9282

**AU-AH.P**  
AUDI

AKS-CASI-UBE-WITTE

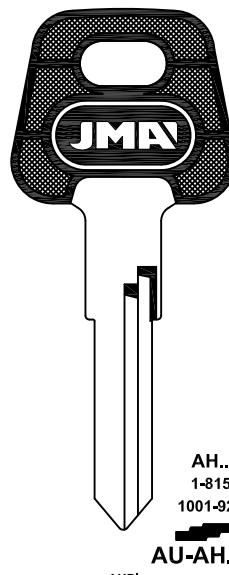

AH...  
1-8154  
1001-9282

**AU-AH.P1**  
AUDI

WITTE

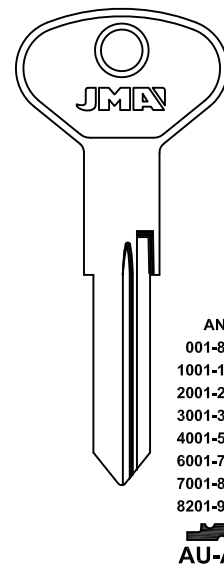

AN  
001-854  
1001-1918  
2001-2830  
3001-3890  
4001-5151  
6001-7086  
7001-8154  
8201-9282

**AU-AN**  
AUDI-VOLKSWAGEN

AKS-CASI-UBE-WITTE

HUF

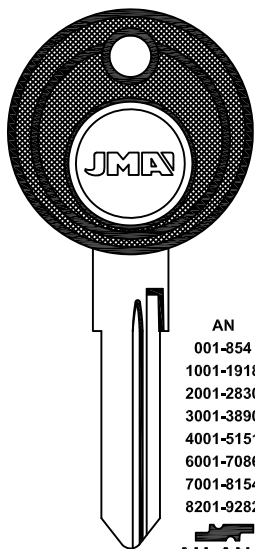

AN  
001-854  
1001-1918  
2001-2830  
3001-3890  
4001-5151  
6001-7086  
7001-8154  
8201-9282

**AU-AN.P**

AUDI-FORD-PORSCHE-VOLKSWAGEN  
AKS-CASI-UBE-WITTE

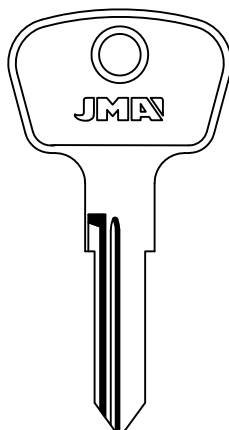

C  
01-32/01-62

**AU-C**

AUDI  
AKS

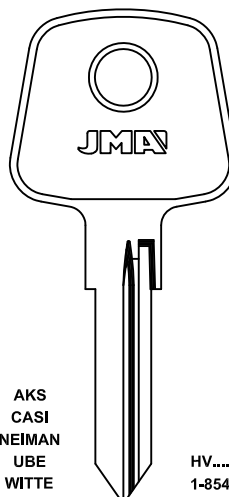

AKS  
CASI  
NEIMAN  
UBE  
WITTE  
YMOS

HV...  
1-854  
1001-9282

**AU-HV**

AUDI-VOLKSWAGEN-SCANIA

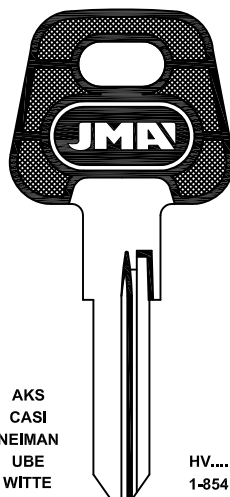

AKS  
CASI  
NEIMAN  
UBE  
WITTE  
YMOS

HV...  
1-854  
1001-9282

**AU-HV.P**

AUDI-VOLKSWAGEN-SCANIA

HUF

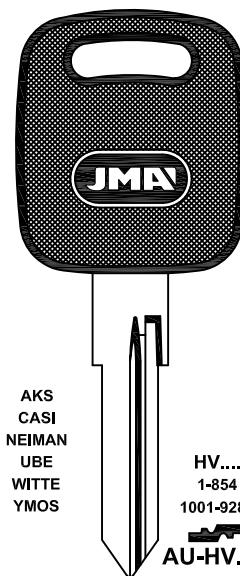

AKS  
CASI  
NEIMAN  
UBE  
WITTE  
YMOS

HV...  
1-854  
1001-9282

**AU-HV.P1**

AUDI

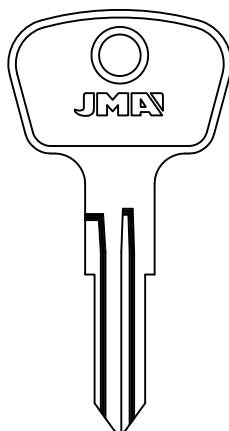

W  
11-91/11-91

**AU-W**

AUDI-VOLKSWAGEN  
AKS-WITTE

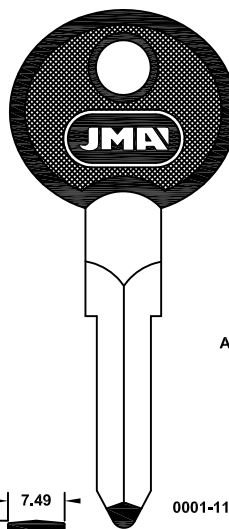

ALP.

7.49  
2.7  
**BM-1.P**

BMW  
PEBRA

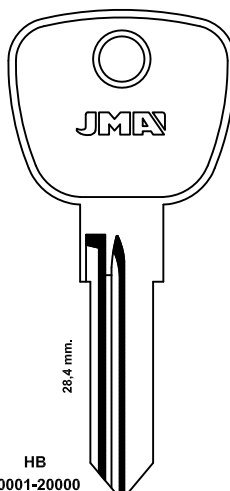

28.4 mm.

HB  
10001-20000  
40001-49999

**BM-2**

BMW



# HUF

PARA-FOR:

HUF (D)

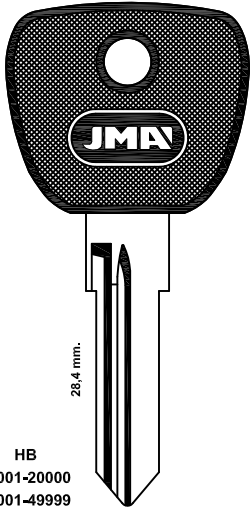

HB  
10001-20000  
40001-49999

BM-2.P

BMW

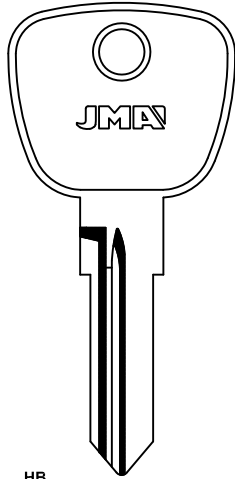

HB  
1-5000

BM-3

BMW

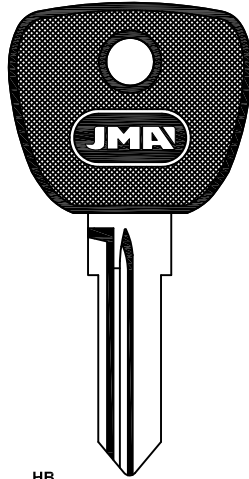

HB  
1-5000

BM-3.P

BMW

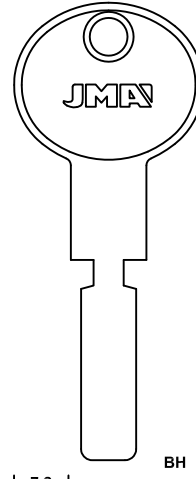

7,2  
3,5

BM-4

BMW  
TIBBE

# HUF

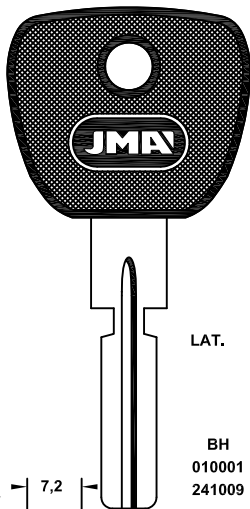

7,2  
3,5

BM-5.P

BMW  
TIBBE

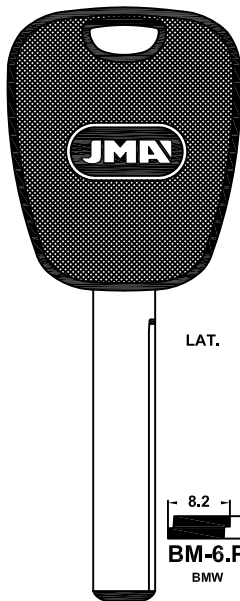

8,2  
2,95

BM-6.P

BMW

PARA FOR  
BM-6RKE  
TP

LAT.



8,2  
2,95

BM-6.P1C1

BMW

ALP.

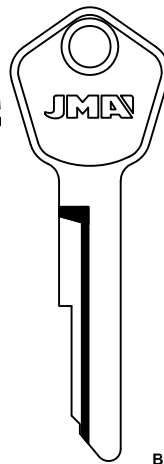

B  
101-300  
401-630

BM-B

BMW  
WITTE

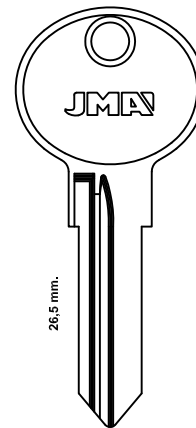

26,5 mm.

HB  
1-5000

BM-HB

BMW

NB  
1-5000

BM-NB

BMW

# HUF

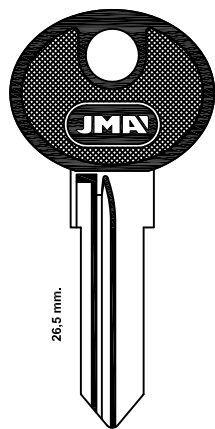

26,5 mm.

HB  
1-5000

BM-HB.P

BMW

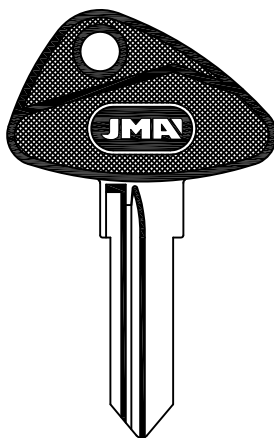

NB  
1-5000

BM-NB.P

BMW

H....P  
12353-53425

BM-HB.P1

NEIMAN

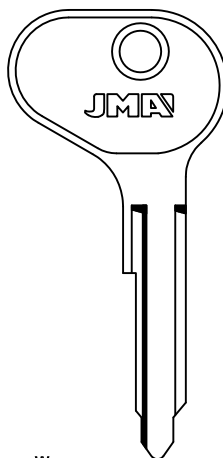

W  
1001-2020  
7001-8000

BM-W

BMW



....1-4000

FO-24C1

ALP.





PARA-FOR:

HUF (D)

HUF



ALP.

....1-4000  
FO-24C2

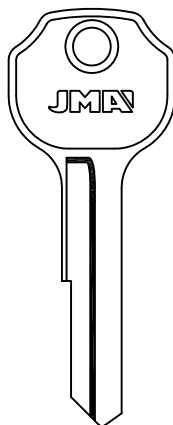

KST...1-240  
ST...1-240  
TST...1-240  
FO-SR  
FORD EUROPA

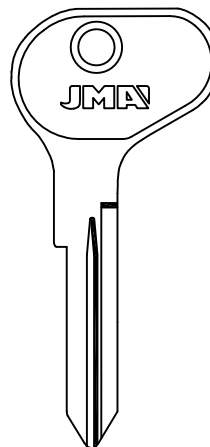

HU-1

NEIMAN-WITTE-YMOS

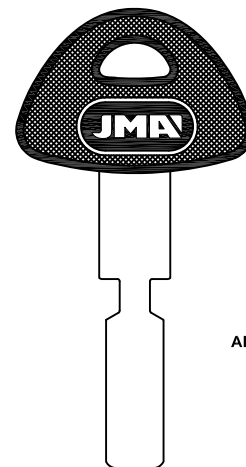

ALP.

....  
1-2000  
7,6  
3,5  
HU-2.P  
SCANIA

HUF

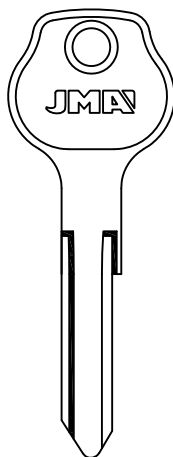

Z  
HU-3

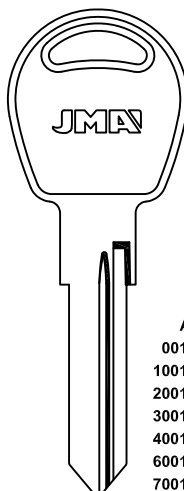

AN  
001-854  
1001-1918  
2001-2830  
3001-3890  
4001-5151  
6001-7086  
7001-8154  
8201-9282  
HU-AN

VOLKSWAGEN  
AKS-CASI-UBE-WITTE

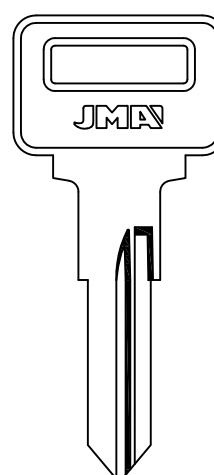

DF-F  
0001-1975  
HU-DF

VOLVO

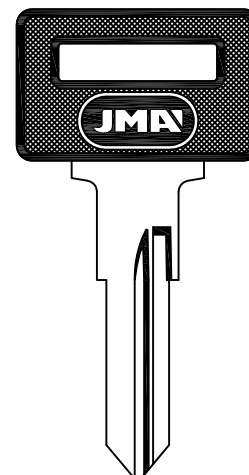

DF-F  
0001-1975  
HU-DF.P

VOLVO

HUF

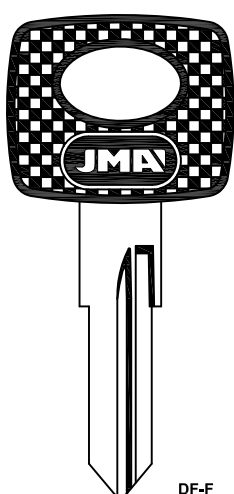

DF-F  
0001-1975  
HU-DF.P1  
VOLVO

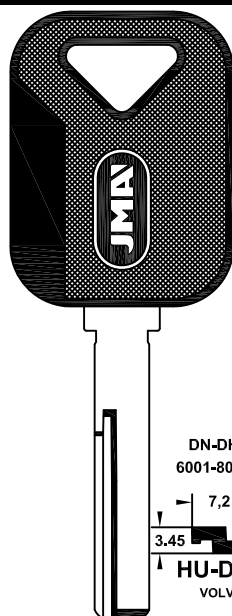

LAT.

DN-DH  
6001-8000  
7,2  
3,45  
HU-DH.P  
VOLVO

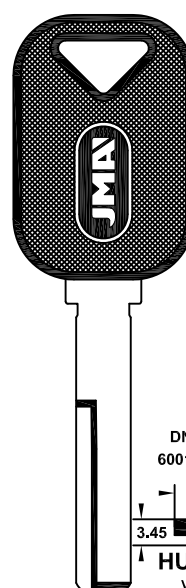

LAT.

DN-DH  
6001-8000  
7,2  
3,45  
HU-DN.P  
VOLVO



ALP.

HU-HAAC1



# HUF

PARA-FOR:

HUF (D)

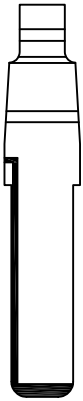

ALP.

HU-HAAC2

HU-NAAC2

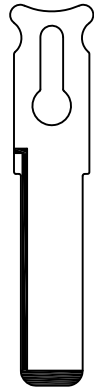

HU-HAAC5

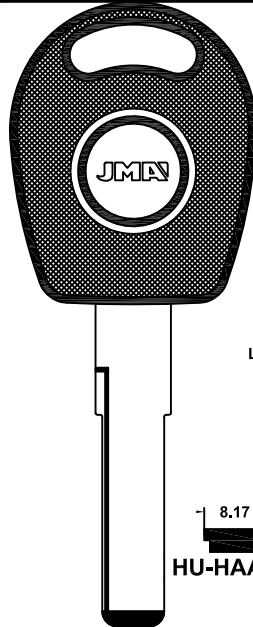

LAT.

HU-HAA.P1

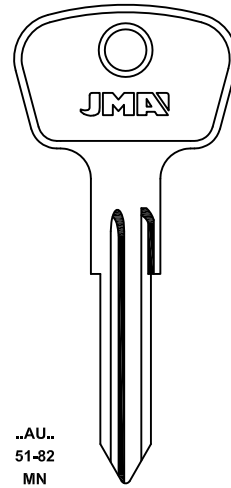

..AU..  
51-82  
MN  
0001-1000  
HU-MN

MAN

# HUF

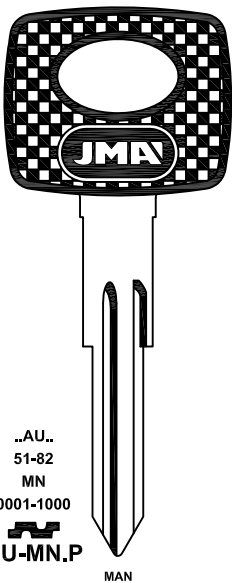

..AU..  
51-82  
MN  
0001-1000  
HU-MN.P

MAN

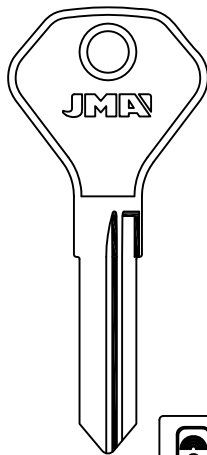

NW...  
1-51

HU-NW

BOSCH

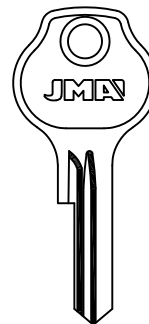

P  
001-252  
HU-P

VDO

# HUF

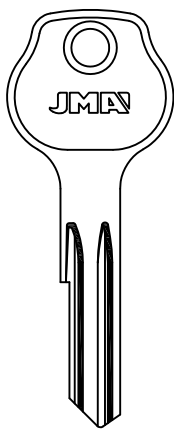

SE  
001-750  
SC  
401-630  
HU-SC

BMW-MAN-PORSCHE-STEYR PUCH-VOLKSWAGEN-SCANIA  
AKS

SR  
001-240  
KSR  
001-240  
LSR  
001-240  
TSR  
001-240  
HU-SR



SZ  
1-240  
HU-SZ

SU  
001-240  
401-630  
HU-SU  
SX  
001-240  
HU-SX

SY  
001-240  
HU-SY

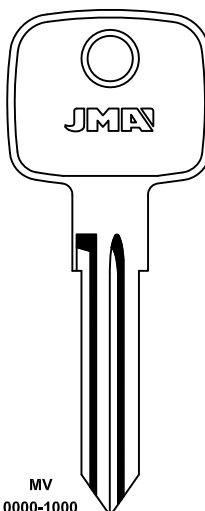

MV  
0000-1000  
ME-1

MERCEDES  
CLAUSOR

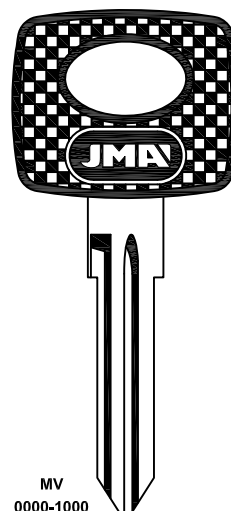

MV  
0000-1000  
ME-1.P

MERCEDES  
CLAUSOR





PARA-FOR:

HUF (D)

HUF

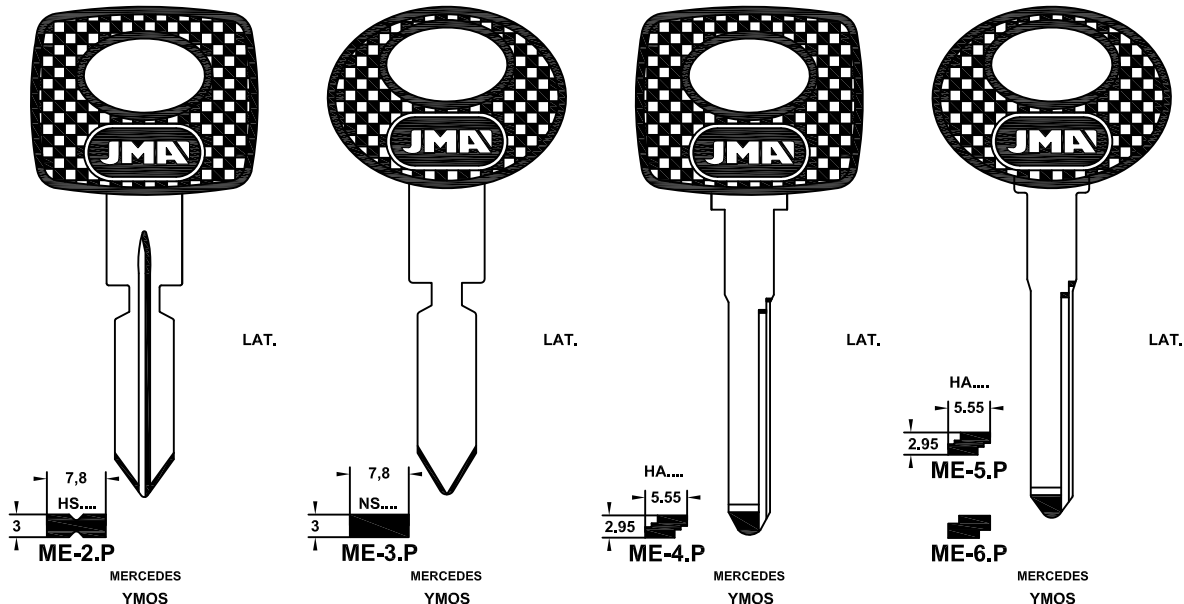

HUF



HUF

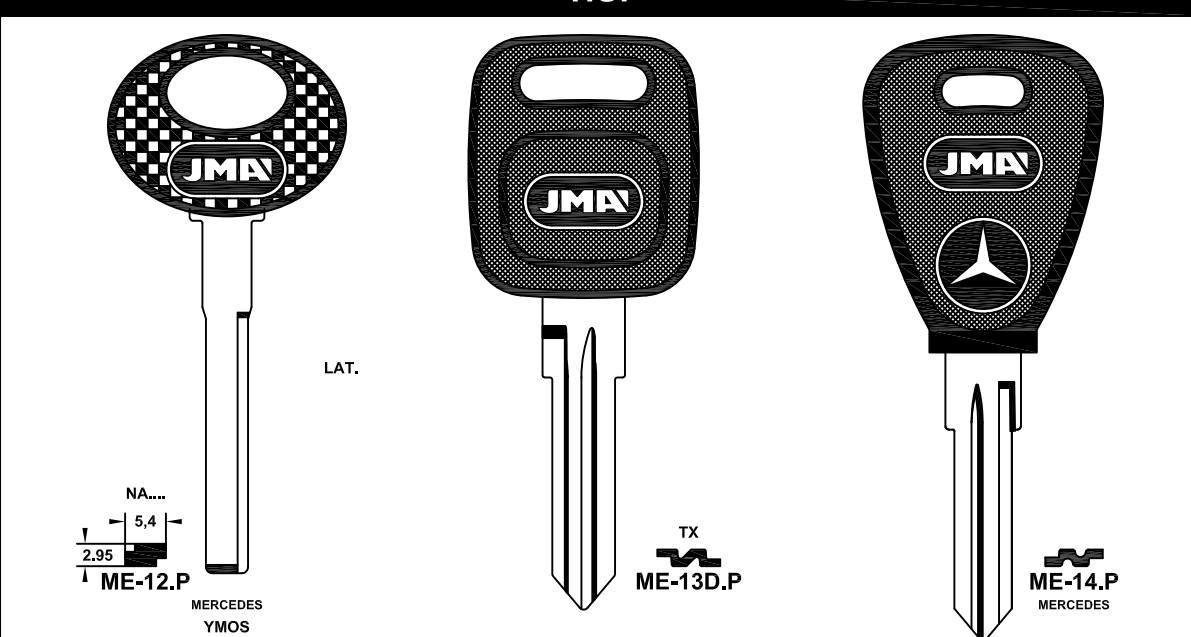

# HUF

PARA-FOR:

HUF (D)

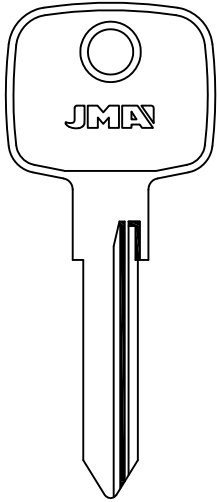

HD 4001-7350  
 NZ 0001-1400  
 NZ 2001-2500  
 NZ 1-99/1-99

**ME-HD**

HZ 0001-1400  
 HZ 2001-3500  
 HZ 4001-5000  
 ND  
 4001-5795  
 5801-7350  
 HZ 1-99/1-99

**ME-HZ**  
 MERCEDES-STEYR PUCH  
 YMOS

..HF..  
 1-99/1-99

HF 0001-1200  
 NM....  
 0001-1200  
 4001-7350

**ME-HF**

HM 0001-1200  
 2501-3500  
 4001-5795  
 5801-7350  
 NF 0001-1200  
 ..NF..  
 1-99/1-99

**ME-HM**

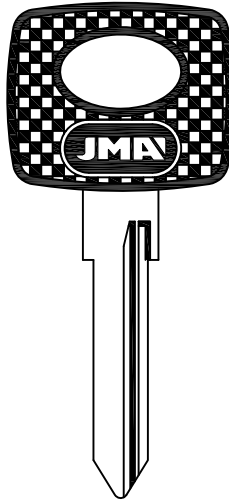

HD 4001-7350  
 NZ 0001-1400  
 NZ 2001-2500  
 NZ 1-99/1-99

**ME-HD.P**

HZ 0001-1400  
 HZ 2001-3500  
 HZ 4001-5000  
 ND  
 4001-5795  
 5801-7350  
 HZ 1-99/1-99

**ME-HZ.P**  
 MERCEDES-STEYR PUCH  
 YMOS

..HF..  
 1-99/1-99

HF 0001-1200  
 NM....  
 0001-1200  
 4001-7350

**ME-HF.P**

HM 0001-1200  
 2501-3500  
 4001-5795  
 5801-7350  
 NF 0001-1200  
 ..NF..  
 1-99/1-99

**ME-HM.P**

# HUF

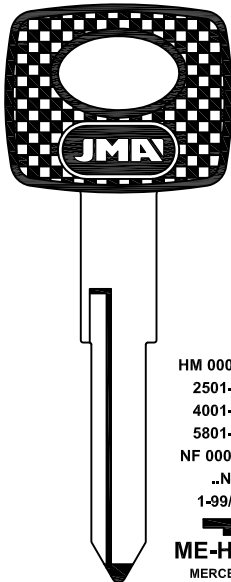

HM 0001-1200  
 2501-3500  
 4001-5795  
 5801-7350  
 NF 0001-1200  
 ..NF..  
 1-99/1-99

**ME-HML.P**  
 MERCEDES  
 YMOS

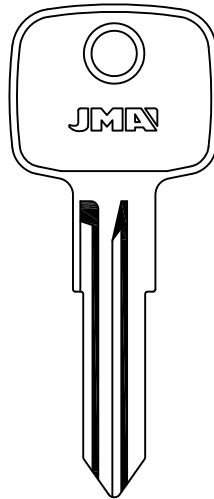

HU  
 6001-8130

**ME-HU**

NU  
 6001-8130

**ME-NU**  
 MERCEDES  
 YMOS

HY  
 6001-8130

**ME-HY**

NY  
 6001-8130

**ME-NY**

# HUF

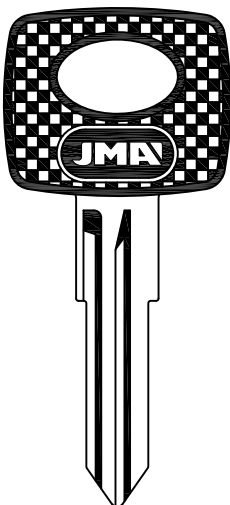

HU  
 6001-8130

**ME-HU.P**

NU  
 6001-8130

**ME-NU.P**  
 MERCEDES  
 YMOS

HY  
 6001-8130

**ME-HY.P**

NY  
 6001-8130

**ME-NY.P**

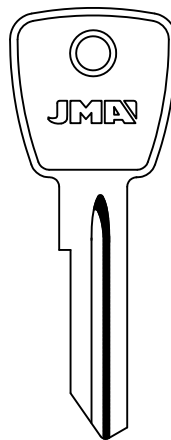

L  
 001-300

**ME-L**  
 MERCEDES  
 IMSA-YMOS

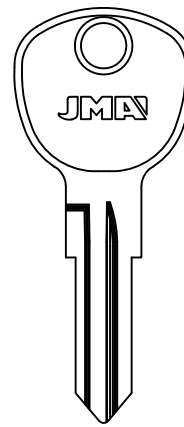

S  
 101-295  
 401-465  
 501-695

**ME-S**  
 MERCEDES  
 CASI



PARA-FOR:

HUF (D)

### HUF

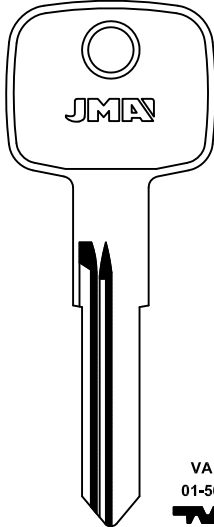
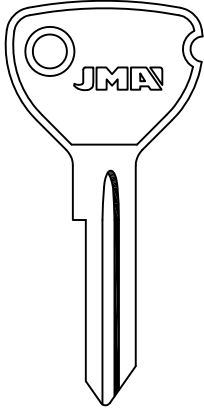
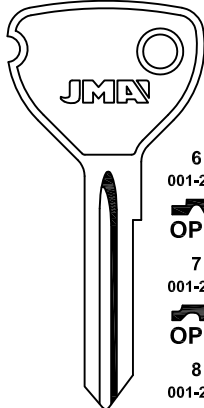
 <p style="text-align: center;">S 101-295 401-465 501-695</p> <p style="text-align: center;"><b>ME-S.P</b> MERCEDES CASI</p>	 <p style="text-align: center;">VA 01-50</p> <p style="text-align: center;"><b>ME-VA</b> HANOMAG-MERCEDES CASI</p>	 <p style="text-align: center;"><b>OP-1</b></p>	 <p style="text-align: center;">6 001-250 <b>OP-6</b> 7 001-250 <b>OP-7</b> 8 001-250 <b>OP-8</b> 9 001-250 <b>OP-9</b></p> <p style="text-align: center;"><b>DAEWOO-OPEL-VAUXHALL</b> YMOS</p>
---	---	---	--

### HUF

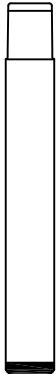
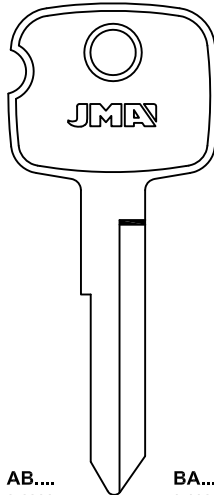
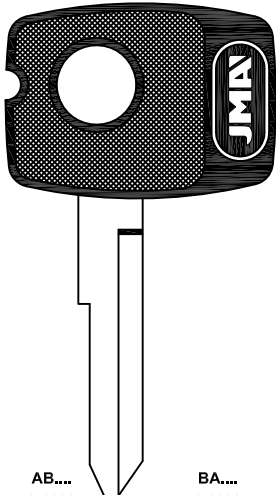
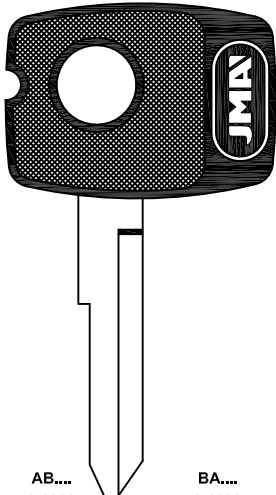
 <p style="text-align: center;">ALP.</p> <p style="text-align: center;">Z...1-2000 Z...2001-4000 Z...4001-6000</p> <p style="text-align: center;"><b>OP-11C1</b></p>	 <p style="text-align: center;">AB... 1-1000 <b>OP-AB</b> DAEWOO-HOLDEN-OPEL-VAUXHALL YMOS</p>	 <p style="text-align: center;">BA... 1-1000 <b>OP-BA</b> DAEWOO-HOLDEN-OPEL-VAUXHALL YMOS</p>	 <p style="text-align: center;">AB... 1-1000 <b>OP-AB.P</b> DAEWOO-HOLDEN-OPEL-VAUXHALL YMOS</p>
--	---	--	--

### HUF

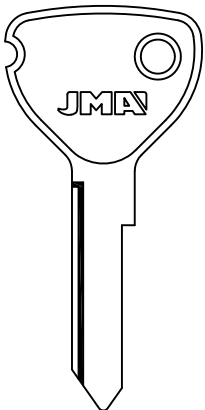
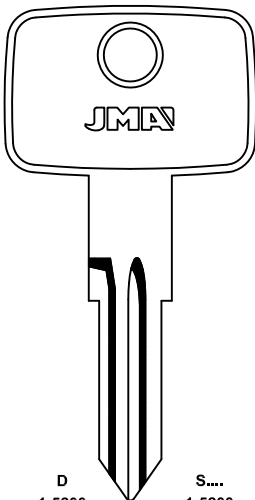
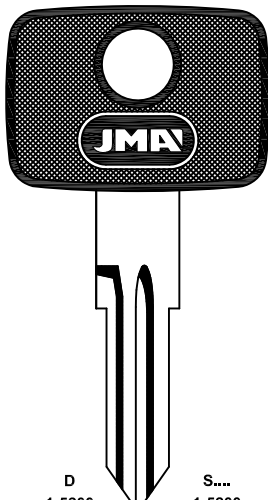







 <p style="text-align: center;">B...1-380 BB...501-1000 BB...1751-2000 BB...2501-3000</p> <p style="text-align: center;"><b>OP-BB</b> DAEWOO-OPEL-VAUXHALL</p>	<p style="text-align: center;">CC...501-1000 CC...1751-2000 CC...2501-3000</p> <p style="text-align: center;"><b>OP-CC</b></p> <p style="text-align: center;">EE...501-1000 EE...1751-2000 EE...2501-3000</p> <p style="text-align: center;"><b>OP-EE</b> DAEWOO-OPEL-VAUXHALL</p>	<p style="text-align: center;">DD...501-1000 DD...1751-2000 DD...2501-3000</p> <p style="text-align: center;"><b>OP-DD</b></p> <p style="text-align: center;">FF...501-1000 FF...1751-2000 FF...2501-3000</p> <p style="text-align: center;"><b>OP-FF</b></p>	 <p style="text-align: center;">D 1-5200 <b>OP-D</b> DAEWOO-GM-LOTUS-OPEL-VAUXHALL YMOS</p> <p style="text-align: center;">S... 1-5200 <b>OP-S</b> DAEWOO-GM-LOTUS-OPEL-VAUXHALL YMOS</p>	 <p style="text-align: center;">D 1-5200 <b>OP-D.P</b> DAEWOO-GM-LOTUS-OPEL-VAUXHALL YMOS</p> <p style="text-align: center;">S... 1-5200 <b>OP-S.P</b> DAEWOO-GM-LOTUS-OPEL-VAUXHALL YMOS</p>
---	--	---	---	--

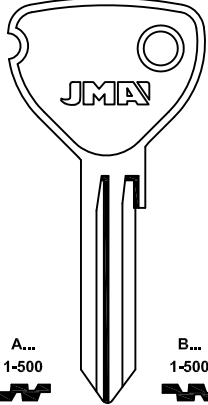
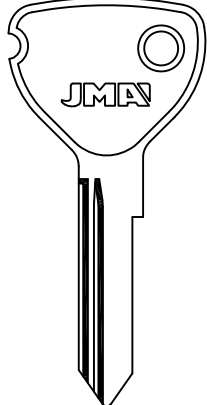
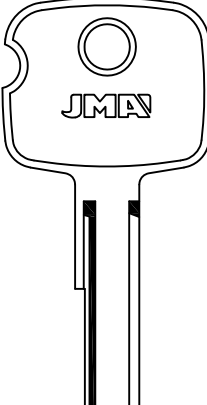
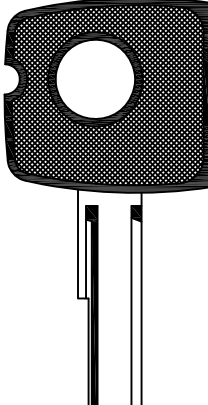





# HUF

PARA-FOR:



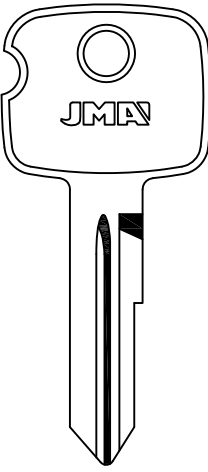
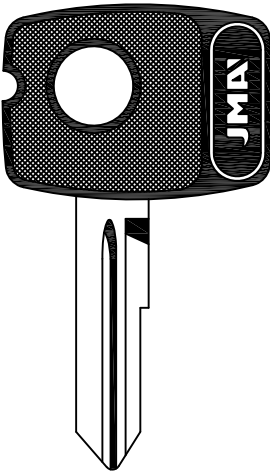
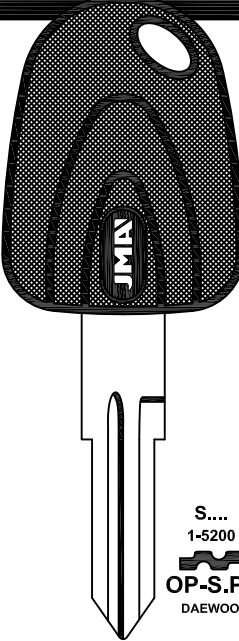
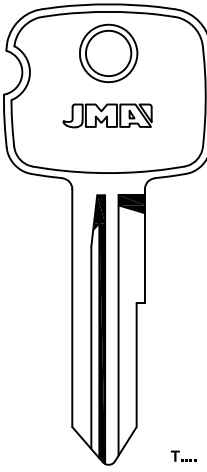



HUF (D)

			
A... 1-500  <b>OP-HA</b>	B... 1-500  <b>OP-HB</b>	G...1-250 H...1-250 G...1251-1500 H...1251-1500  <b>OP-HG</b>	J... 1-2874  <b>OP-HH</b>
A... 1-500  <b>OP-NA</b> OPEL-VAUXHALL YMOS	B... 1-500  <b>OP-NB</b> OPEL-VAUXHALL YMOS	G...1-250 H...1-250 G...1251-1500 H...1251-1500  <b>OP-J</b> DAEWOO-HOLDEN-OPEL-VAUXHALL YMOS	J... 1-2874  <b>OP-J.P</b> DAEWOO-HOLDEN-OPEL-VAUXHALL YMOS

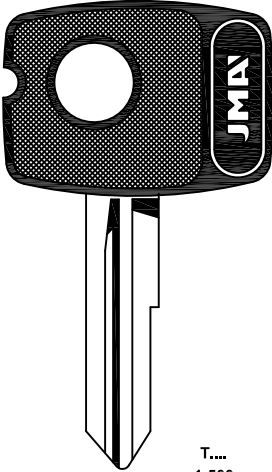
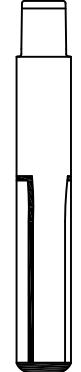
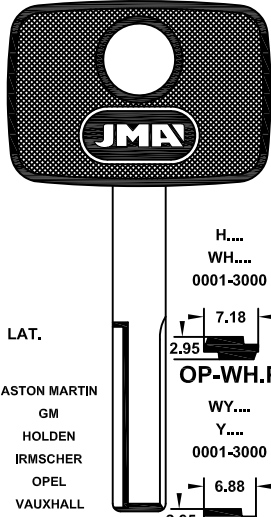
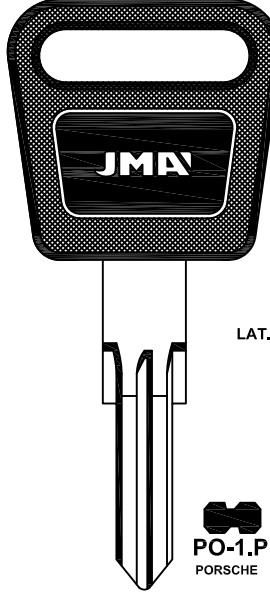
# HUF

			
R... 1-1500  <b>OP-R</b> GM-IRMSCHER-OPEL-VAUXHALL YMOS	R... 1-1500  <b>OP-R.P</b> GM-IRMSCHER-OPEL-VAUXHALL YMOS	S... 1-5200  <b>OP-S.P1</b> DAEWOO	T... 1-500 501-1500  <b>OP-T</b> GM-IRMSCHER-OPEL-VAUXHALL YMOS

# HUF

			
T... 1-500 501-1500  <b>OP-T.P</b> GM-IRMSCHER-OPEL-VAUXHALL YMOS	H... WH... 0001-3000  <b>OP-WHC1</b>	H... WH... 0001-3000 ALP. LAT. ASTON MARTIN GM HOLDEN IRMSCHER OPEL VAUXHALL 7.18 2.95  <b>OP-WH.P</b> WY... Y... 0001-3000 6.88 2.95  <b>OP-WY.P</b> YMOS	LAT.  <b>OP-1.P</b> PORSCHE



PARA-FOR:

HUF (D)

### HUF

36,5 mm.

LAT.

PO-2.P  
PORSCHÉ

HC....  
0001-2080  
PO-HC  
NC....  
0001-2080  
PO-NC  
PORSCHÉ  
DOM

HC....  
0001-2080  
PO-HC.P  
NC....  
0001-2080  
PO-NC.P  
PORSCHÉ  
DOM

AKS  
CASI  
NEIMAN  
UBE  
WITTE  
YMOS

AH....  
1-8154  
1001-9282  
SE-AH.P  
SEAT

### HUF

...124-197  
...501-598  
...701-790  
...G06-G10  
...0G1-1G0  
A...101-125  
A...701-790  
G...001-100

SE-AN  
SEAT

VO-1  
FIAT IVECO  
NEIMAN

AH....  
1-8154  
1001-9282  
VO-2  
VOLKSWAGEN  
AKS-CASI-UBE-WITTE

AH....  
1-8154  
1001-9282  
VO-2.P  
2FF  
VO-8.P  
VOLKSWAGEN  
AKS-CASI-UBE-WITTE

VO-2D.P

### HUF

AH....  
1-8154  
1001-9282  
VO-2.P1  
2FF  
VO-8.P1  
VOLKSWAGEN BRASIL

VO-2D.P1

AN  
001-854  
1001-1918  
2001-2830  
3001-3890  
4001-5151  
6001-7086  
7001-8154  
8201-9282  
VO-5.P  
CASI-HUF-UBE-WITTE

VO-6D



# HUF

PARA-FOR:

HUF (D)

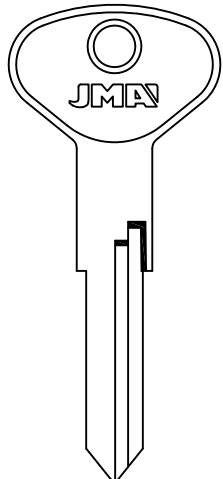

AH...  
1-8154  
1001-9282

 VO-AH

HV...  
1-8154  
1001-9282

 VO-HV

VB-NV-MD...  
1-8154  
1001-9282

 VO-VB

N...  
 VO-N



AN...  
001-854  
1001-1918  
2001-2830  
3001-3890  
4001-5151  
6001-7086  
7001-8154  
8201-9282

 AU-AN

AUDI-FORD-PORSCHE-VOLKSWAGEN  
AKS-CASI-LUBE-WITTE

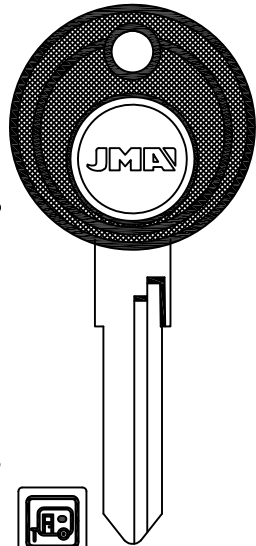

AH...  
1-8154  
1001-9282

 VO-AH.P

HV...  
1-8154  
1001-9282

 VO-HV.P

VB-NV-MD...  
1-8154  
1001-9282

 VO-VB.P

N...  
 VO-N.P





AN...  
001-854  
1001-1918  
2001-2830  
3001-3890  
4001-5151  
6001-7086  
7001-8154  
8201-9282

 AU-AN.P

AUDI-FORD-PORSCHE-VOLKSWAGEN  
AKS-CASI-LUBE-WITTE

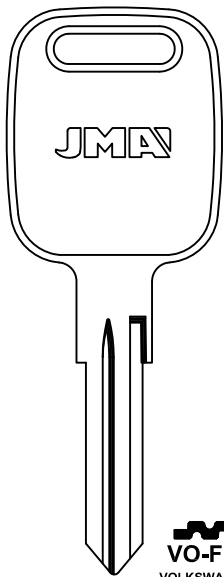
# HUF



 VO-FH

VOLKSWAGEN

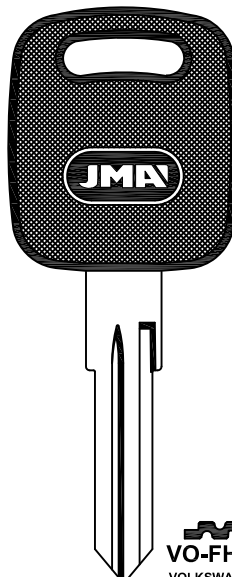

 VO-FH.P

VOLKSWAGEN

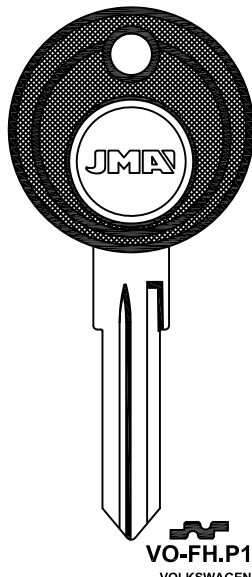

 VO-FH.P1

VOLKSWAGEN

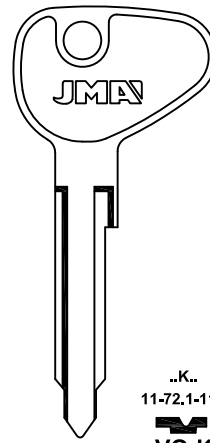

..K...  
11-72.1-110

 VO-K

..L...  
11-72.1-110

 VO-L

VOLKSWAGEN  
NEIMAN-WITTE

# HUF

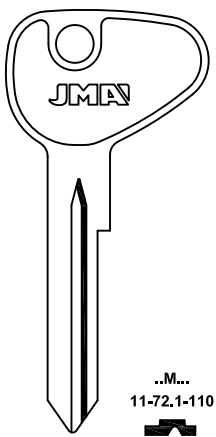

..M...  
11-72.1-110

 VO-M



..R...  
11-72.1-110

 VO-R

MAN-VOLKSWAGEN  
AKS-CASI-WITTE

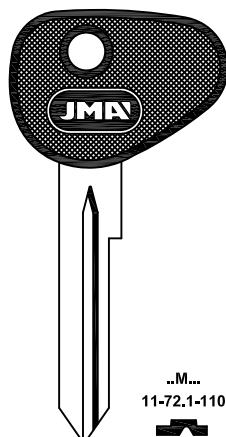

..M...  
11-72.1-110

 VO-M.P

..R...  
11-72.1-110

 VO-R.P

MAN-VOLKSWAGEN  
AKS-CASI-WITTE

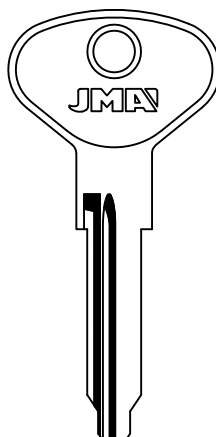

..VA...  
01-55

 VO-VA

VOLKSWAGEN

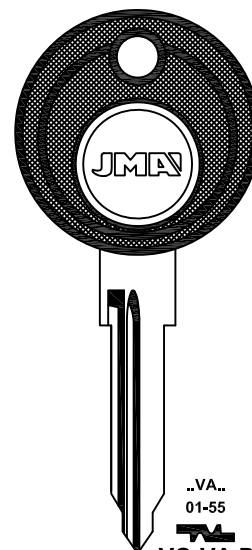

..VA...  
01-55

 VO-VA.P

VOLKSWAGEN











**PARA-FOR:**

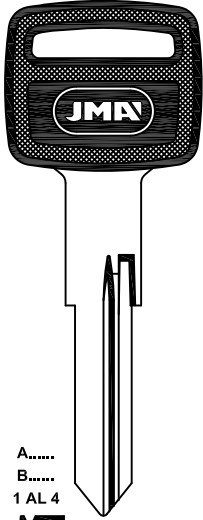
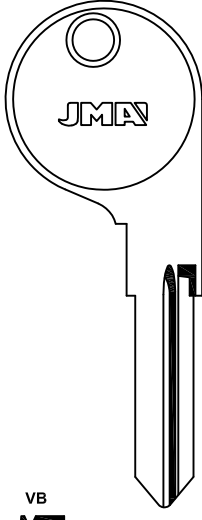
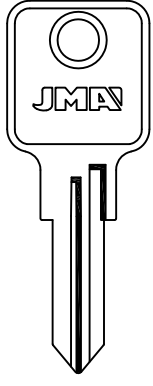
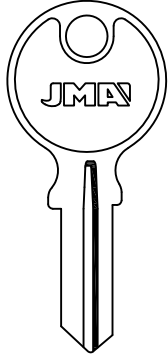





HUF (D)

HUWIL (D)

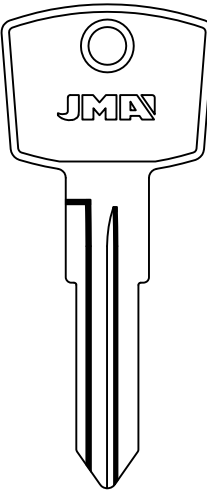
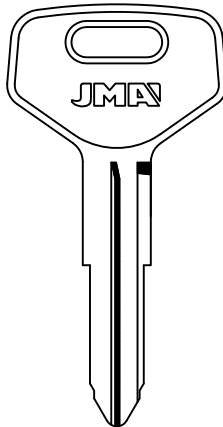
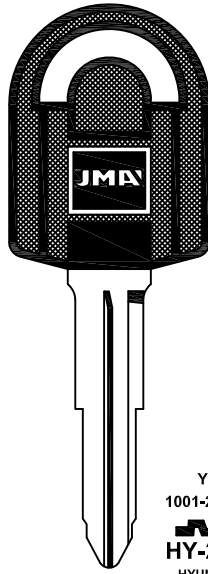
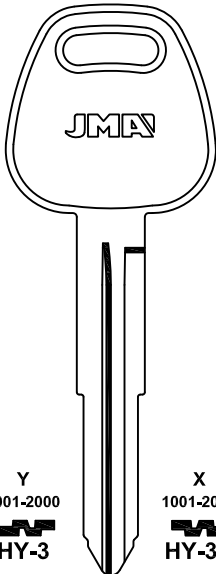





HYUNDAI (K)

HUF		HUWIL	
			
A..... B..... 1 AL 4  VO-VB.P1 NEIMAN	VB  VW-K70	W 3000-4000 A 3001-4000  HUW-1  HUW-1D STRAFOR-STEELCASE	N 0005-1878 N 2001-2204  HUW-N TECNO

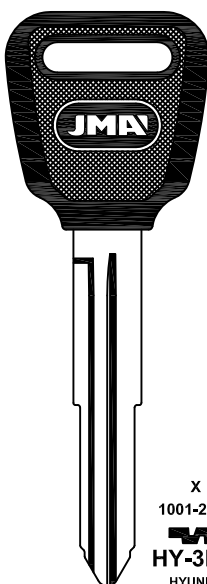
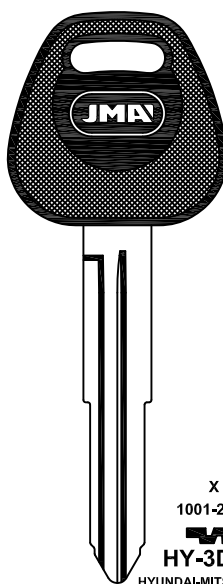
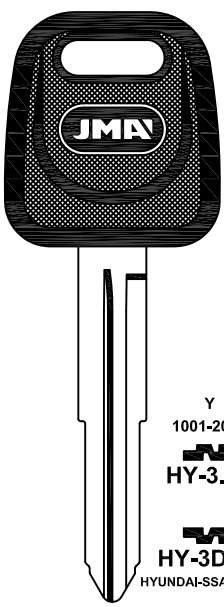
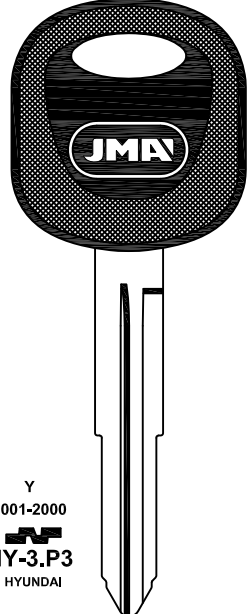
**HYUNDAI**

			
A/Z.... 0111-0333  HY-1 HYUNDAI	Y 1001-2000  HY-2 HYUNDAI	Y 1001-2000  HY-2.P HYUNDAI	Y 1001-2000  HY-3 HYUNDAI-MITSUBISHI X 1001-2000  HY-3D HYUNDAI-MITSUBISHI

**HYUNDAI**

			
X 1001-2000  HY-3D.P HYUNDAI	X 1001-2000  HY-3D.P1 HYUNDAI-MITSUBISHI	Y 1001-2000  HY-3.P2  HY-3D.P2 HYUNDAI-SSANGYONG	Y 1001-2000  HY-3.P3 HYUNDAI



# HYUNDAI

PARA-FOR:  
HYUNDAI (K)

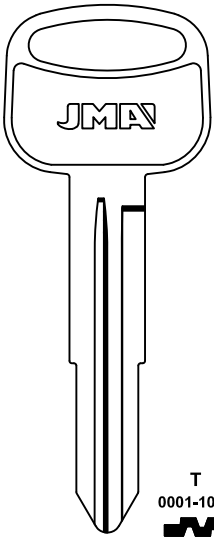

T  
0001-1000  
HY-4  
HYUNDAI

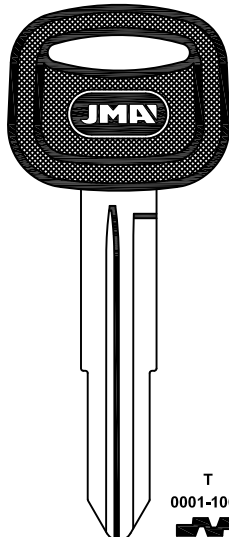

T  
0001-1000  
HY-4.P  
HYUNDAI

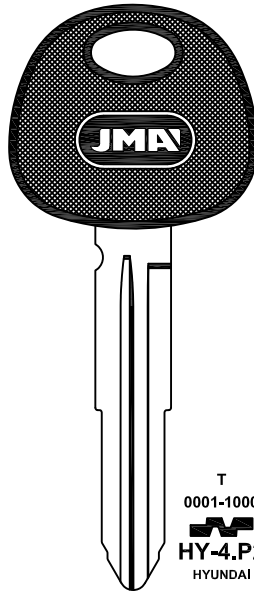

T  
0001-1000  
HY-4.P2  
HYUNDAI

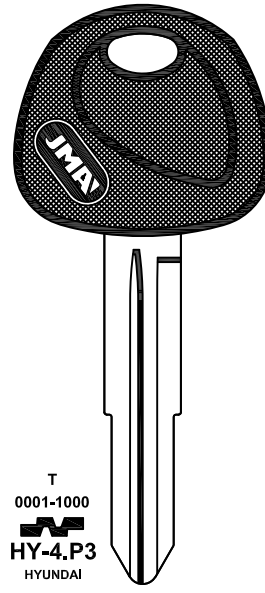

T  
0001-1000  
HY-4.P3  
HYUNDAI

# HYUNDAI

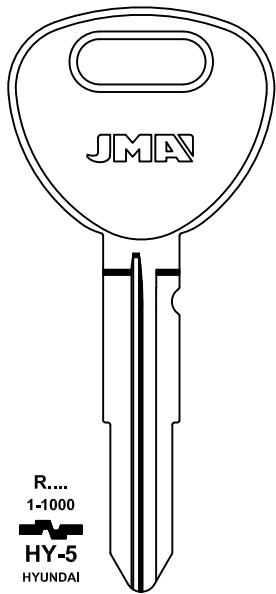

R...  
1-1000  
HY-5  
HYUNDAI

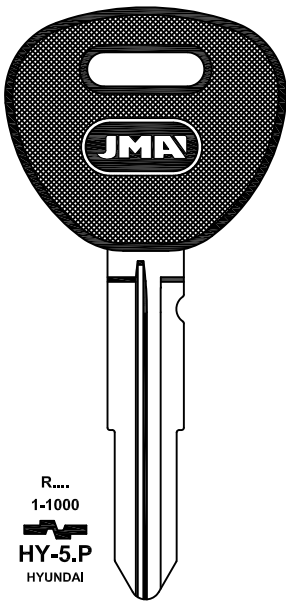

R...  
1-1000  
HY-5.P  
HYUNDAI

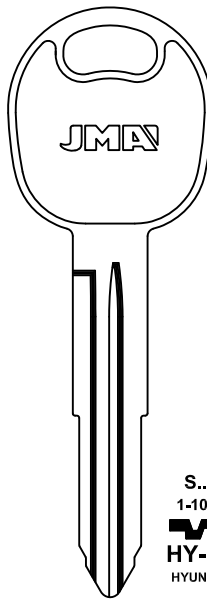

S...  
1-1000  
HY-6D  
HYUNDAI

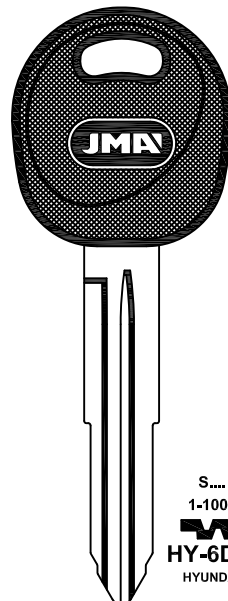

S...  
1-1000  
HY-6D.P  
HYUNDAI

# HYUNDAI

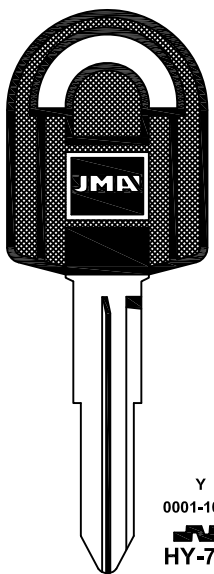

Y  
0001-1000  
HY-7.P  
HYUNDAI

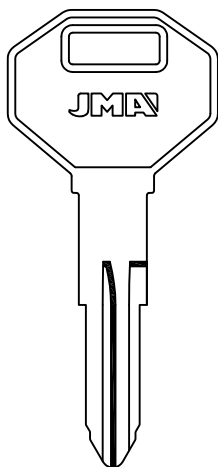

H  
1-2000  
HY-8  
HYUNDAI

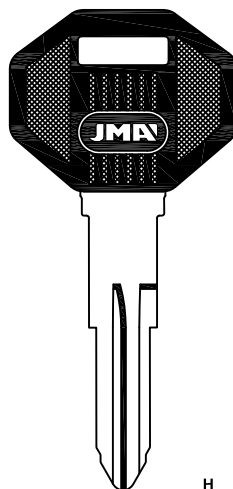

H  
1-2000  
HY-8.P  
HYUNDAI

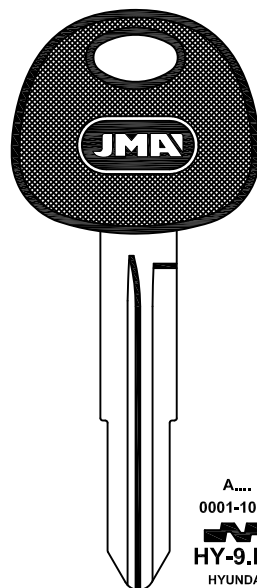

A...  
0001-1000  
HY-9.P2  
HYUNDAI





**PARA-FOR:**

HYUNDAI (K)

IMSA (E)

**HYUNDAI**

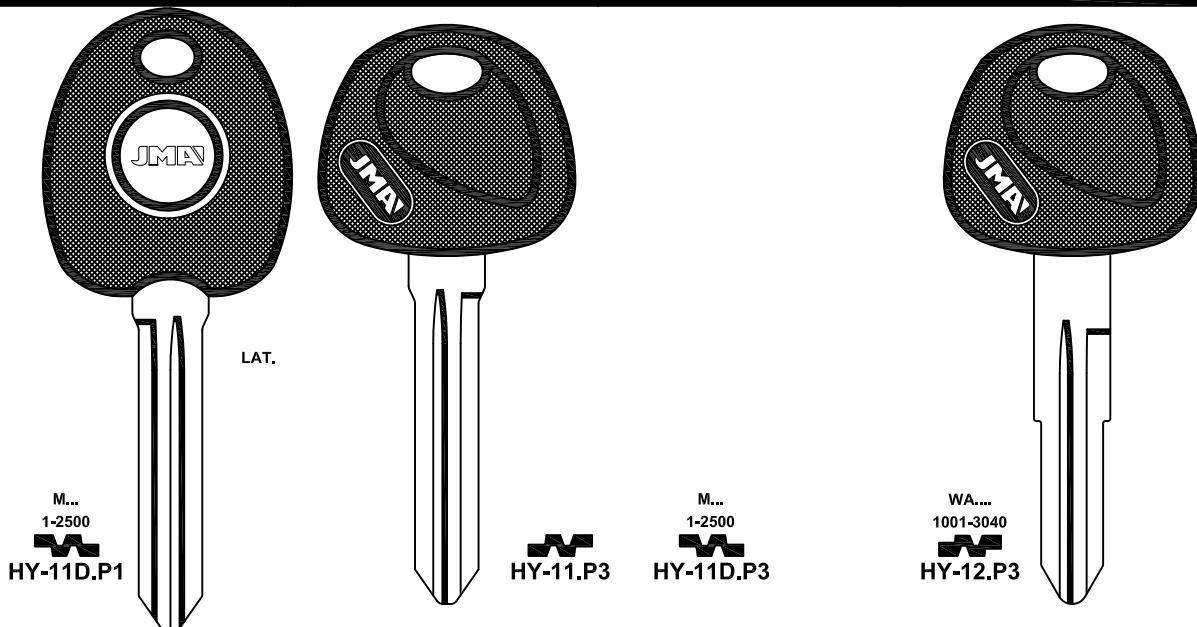

**IMSA**

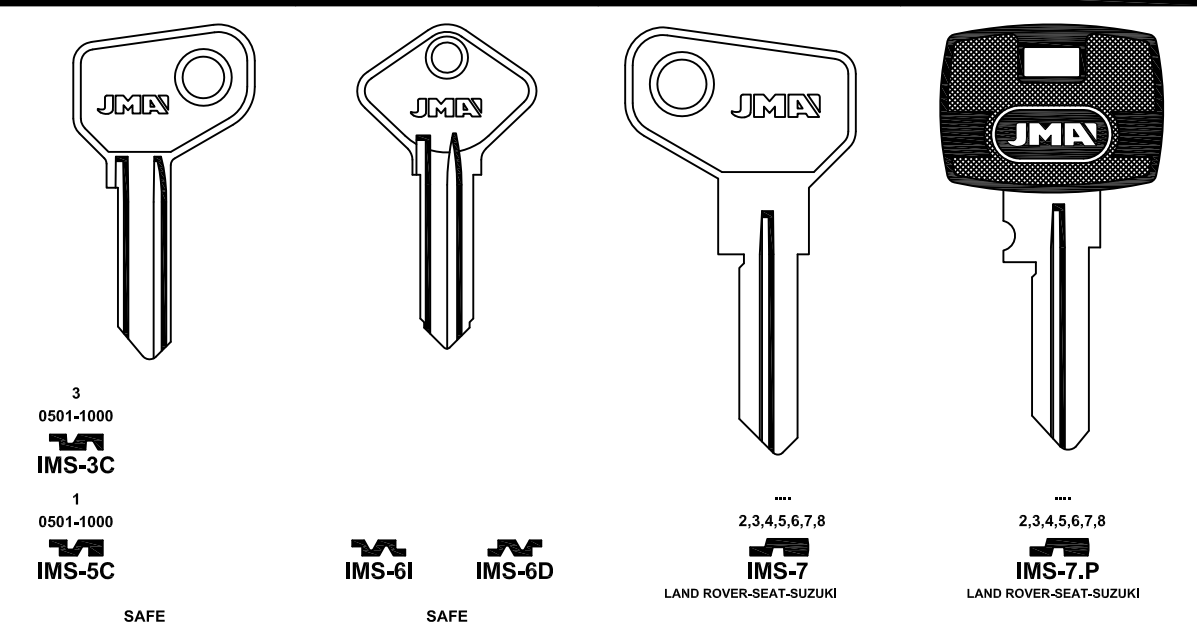

**IMSA**

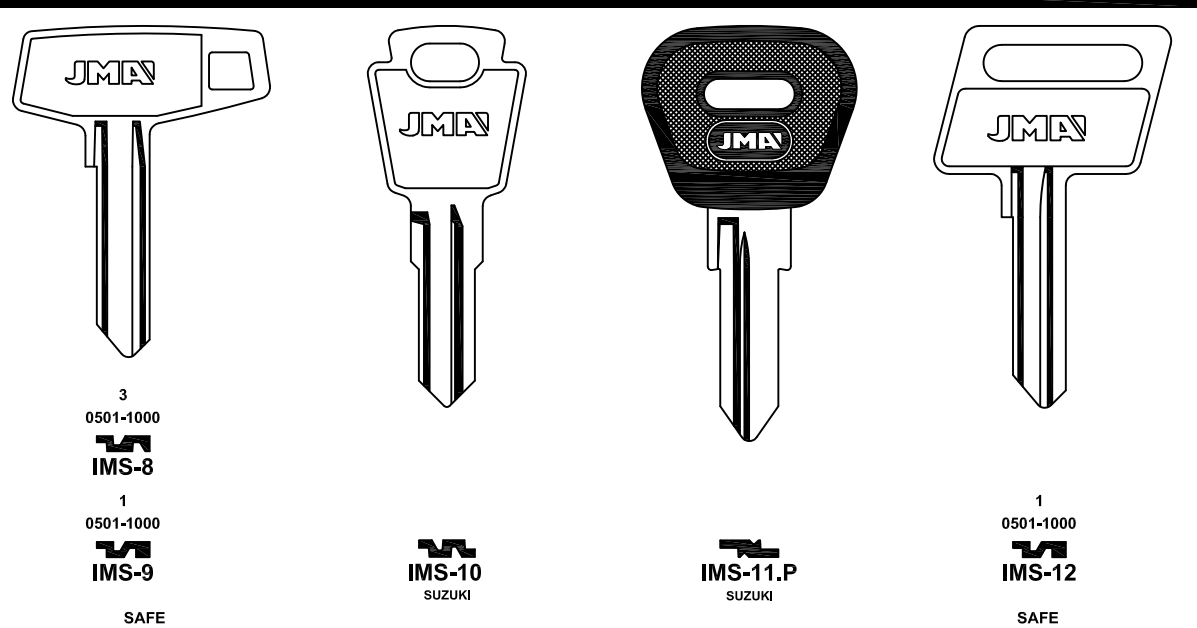

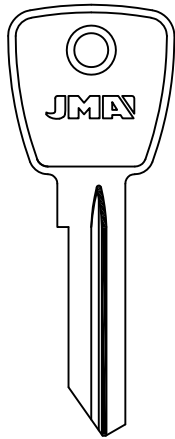
**IMSA**L  
001-300

SAFE

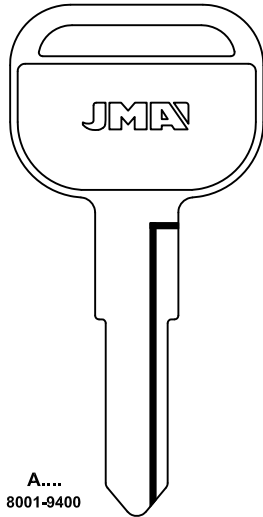
**ISUZU**A....  
8001-9400

ISUZU

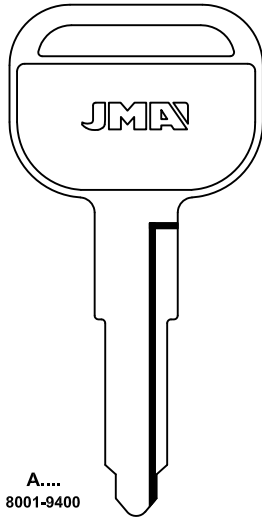
A....  
8001-9400

ISUZU

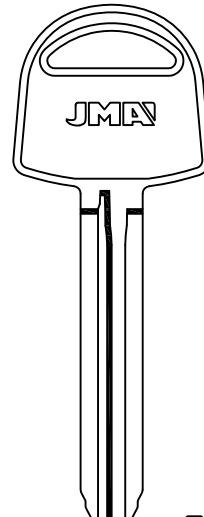

ISUZU

**PARA-FOR:**

IMSA (E)

ISUZU (J)

JOHN DEERE  
(USA)

KAMAZ (RUS)

KAWASAKI (J)

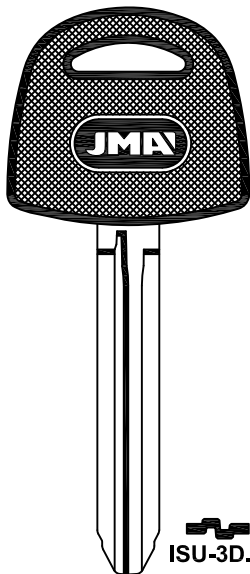
**ISUZU**

ISUZU

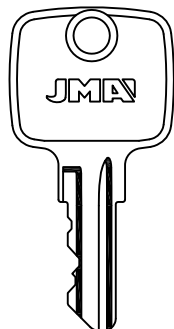
**JOHN DEERE**

LAT.



JD-1

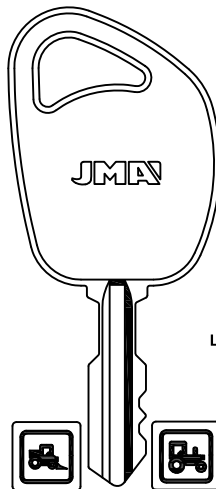

LAT.



JD-2

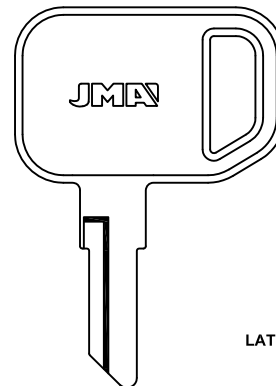

LAT.

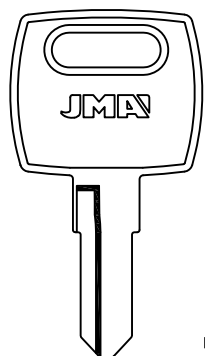

JD-3D

**JOHN DEERE**

LAT.

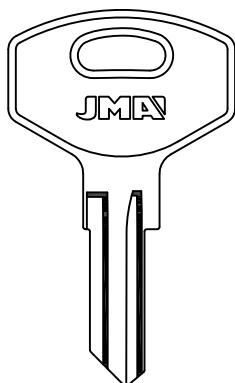

JD-4D

**KAMAZ**

KAM-1

KAM-1D

ZIL

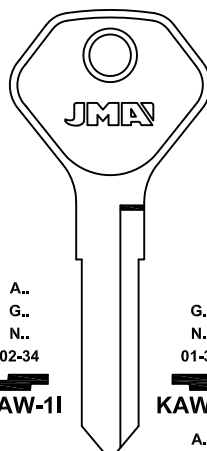
**KAWASAKI**A..  
G..  
N..  
02-34

KAW-1I

B....  
1 AL 4

KAW-2I

KAWASAKI

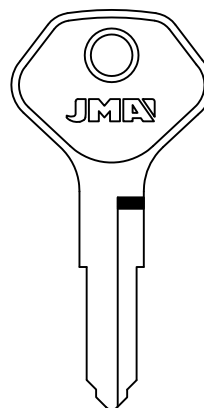
G..  
N..  
01-35

KAW-1D

A..  
G..  
N..  
1 AL 4

KAW-2D

Z  
5000-6000

KAW-3

KAWASAKI



**PARA-FOR:**

KAWASAKI (J)

KENWORTH  
(USA)

KIA (K)

**KAWASAKI**

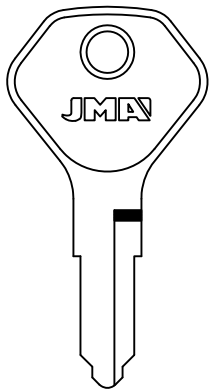

751-795  
PLC  
401-600  
  
**KAW-4**  
HYUNDAI-KAWASAKI

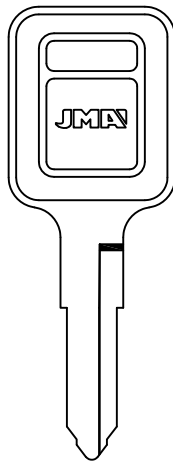

Z....  
5000-6000  
  
**KAW-5**  
KAWASAKI

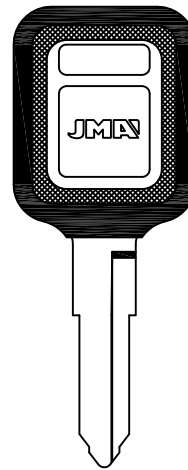

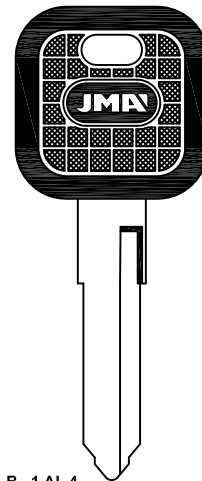

Z....  
5000-6000  
  
**KAW-5.P**  
KAWASAKI

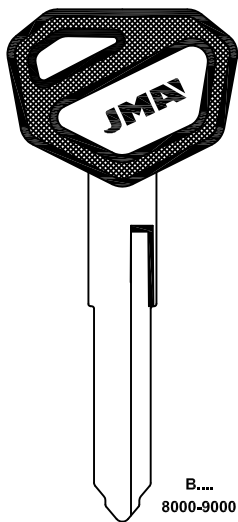

B.. 1 AL 4  
H.. 1 AL 4  
  
**KAW-6.P** **KAW-6D.P**  
CAGIVA-DUCATI-KAWASAKI

**KAWASAKI**



B....  
8000-9000  
  
**KAW-7.P**  
KAWASAKI

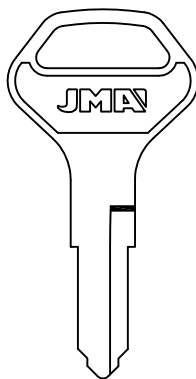

  
**KAW-8** **KAW-8D**

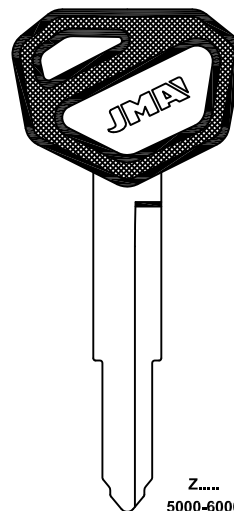

Z....  
5000-6000  
  
**KAW-9.P**  
KAWASAKI

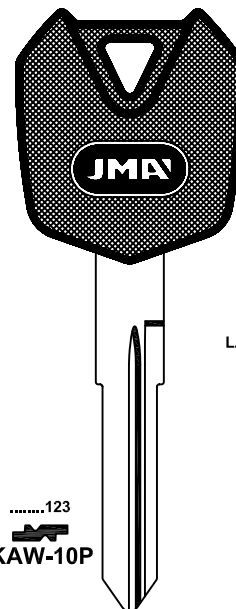



.....123  
  
**KAW-10P**

LAT.

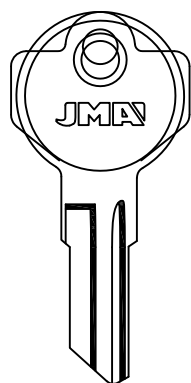
**KENWORTH**



C....  
250-499  
1701-1950  
  
  
**KEN-1** **KEN-1D**  
BASCO

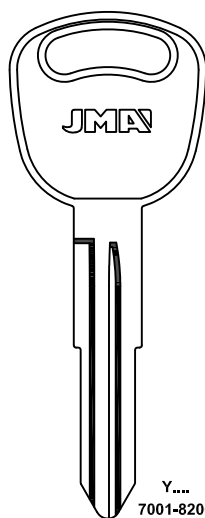

Y....  
7001-8200  
  
**KI-1D**  
FORD (AUSTRALIA)-KIA

**KIA**

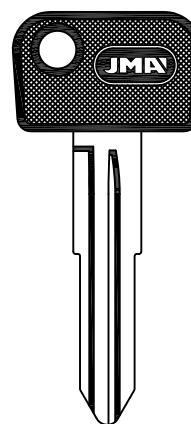



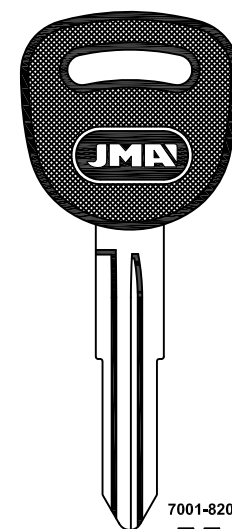



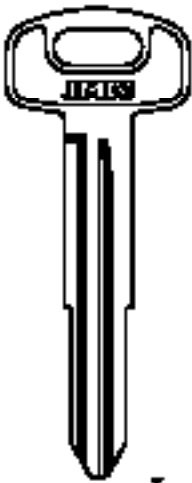
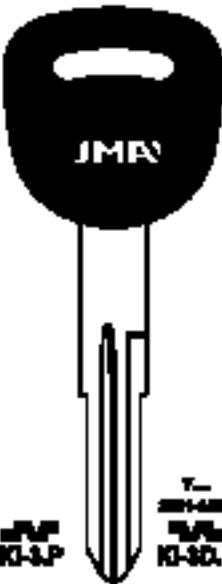

Y....  
7001-8200  
  
**KI-1D.P**

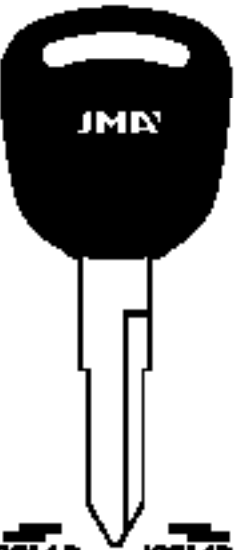
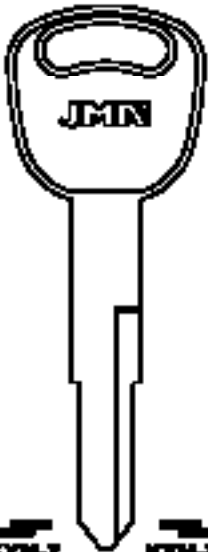
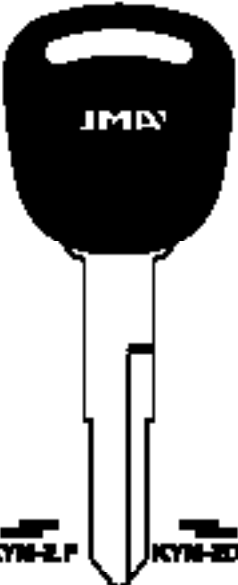
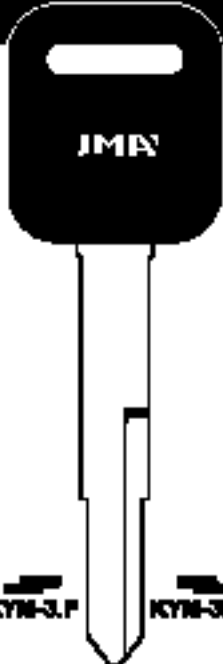
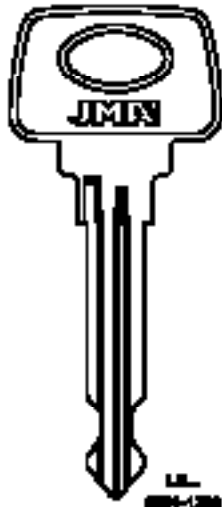

7001-8200  
  
**KI-1D.P1**  
FORD (AUSTRALIA)-KIA



KIA		KOMATSU		KYMCO	
					
Y... V... TEL... K3-3D P... P... P...	Y... S... TEL... K3-3D.P	LAT TEL... K006-1	KYM-1.P KYM-1D.P		
KYMCO			LADA-BAKONY		
					
KYM-2 KYM-2D KYM-2.P	KYM-2D.P KYM-3.P KYM-3D.P	KYM-3.P KYM-3D.P	LA-1D LADA		
LADA-BAKONY					
					
LA-10.P LADA	LA-2 LADA	LA-2.P LADA	LA-3D LADA	LA-3D.P LADA	

**PARA-FOR:**  
 KIA (K)  
 KOMATSU (USA)  
 KYMCO (K)  
 LADA-BAKONY (RUS)



**PARA-FOR:**

LADA-BAKONY  
(RUS)  
LAS (F)  
LMP (F)

LADA-BAKONY		LAS	
LU... 0001-1280 <b>LA-4D</b> LADA	LU... 0001-1280 <b>LA-4D.P</b> LADA	AX 001-224 <b>LAS-AX</b> EX <b>LAS-1D</b>	ABBS ATAL DUBOIS ORDO RENZ STRAFOR FH 001-400 501-550 <b>LAS-FH</b> FM 001-400 501-550 <b>LAS-4</b> <b>LAS-4D</b>
ATAL-HÄFELE-KIFERM-RENZ			

LAS			
FH 001-400 501-550 <b>LAS-3</b> H <b>LAS-5</b> U <b>LAS-U</b>	E <b>LAS-5D</b> X <b>LAS-X</b>	TA <b>LAS-6</b> RM 0001-2000 KT 3001-4000 <b>LAS-KT</b>	AT <b>LAS-6D</b> TK 4001-5000 <b>LAS-TK</b>
KIFERM		ATAL-KIFERM-MARCADET-RONIS	
BT 001-650 <b>LAS-BT</b>	TB 001-650 <b>LAS-TB</b>	CR 001-650 <b>LAS-CR</b>	RC 001-650 <b>LAS-RC</b>
P 001-224 <b>LAS-P</b>	KIFERM-PJ		

LAS		LMP	
R 001-224 <b>LAS-R</b>	V 001-224 <b>LAS-V</b> Y 001-224 <b>LAS-Y</b>	XS 01-75 <b>LAS-XS</b> TX 01-75 <b>LAS-TX</b> XY 01-75 <b>LAS-XY</b>	SX 01-75 <b>LAS-SX</b>
DUBOIS-KIFERM-PJ-PK		10055-12538 <b>LMP-1</b> EBRO-PEUGEOT-RENAULT GELBON-ROS-SEIMA	
10055-12538 <b>LMP-1.P</b> EBRO-PEUGEOT-RENAULT GELBON-ROS-SEIMA		10055-12538 <b>LMP-1.P</b> EBRO-PEUGEOT-RENAULT GELBON-ROS-SEIMA	



## LMP

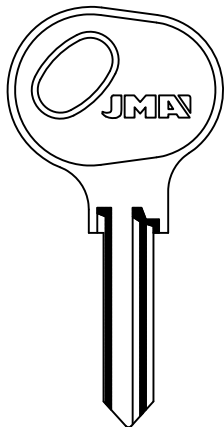

20000-25527  
50001-52500



**LMP-2**

PEUGEOT-RENAULT  
GELBON-SEIMA

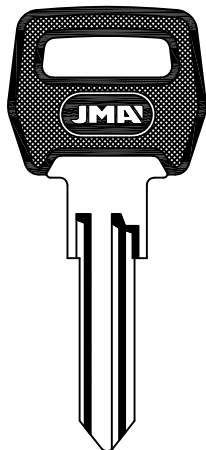

20000-25527  
50001-52500



**LMP-2.P**

PEUGEOT-RENAULT  
GELBON-SEIMA

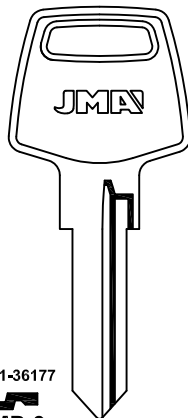

35001-36177



**LMP-3**

70001-72500  
75000-77500  
1AA-7FZ



**LMP-4**

PEUGEOT-RENAULT-TALBOT  
GELBON-SEIMA



**LMP-5**

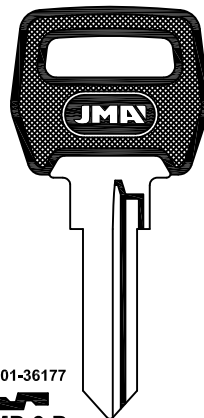

35001-36177



**LMP-3.P**

70001-72500  
75000-77500  
1AA-7FZ



**LMP-4.P**

PEUGEOT-RENAULT-TALBOT  
GELBON-SEIMA



**LMP-5.P**

## PARA-FOR:

LMP (F)

LOWE & FLETCHER

(GB)

## LMP

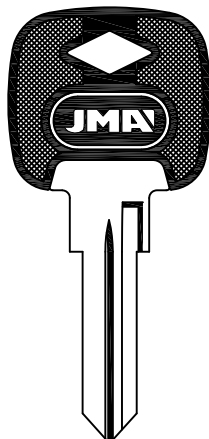

70001-72500  
75000-77500  
1AA-7FZ



**LMP-4.P1**



**LMP-5.P1**

RENAULT  
GELBON-SEIMA

## LOWE & FLETCHER

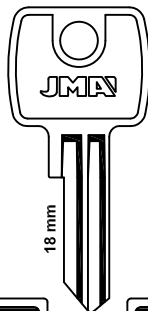

18 mm



90...1-200  
...1-400  
91...201-275  
GH...1-4000  
SS...1-400  
91...276-350



**LF-11**



**LF-1D**

CEM-EURO LOCKS-UNION

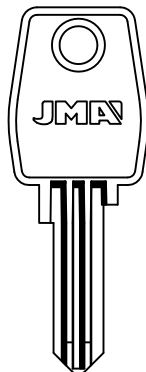

95001-97000  
97001-99000



**LF-2**



**LF-12**



**LF-12D**

BICICLETTA CYCLES  
DOBLE SAFE-EURO LOCKS

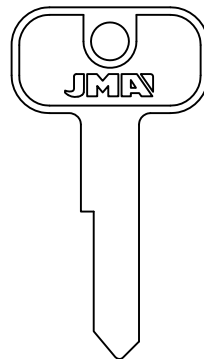

RL-RM  
801-952



**LF-3**

STREBOR

## LOWE & FLETCHER

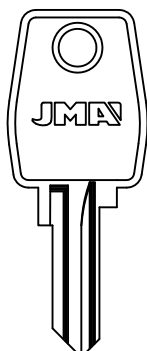

**LF-4I**

EURO LOCKS

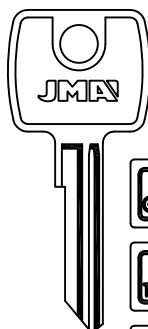

....  
70001-71000  
M....  
70001-71000



**LF-5**



**LF-5D**



**LF-32**

TELFORD

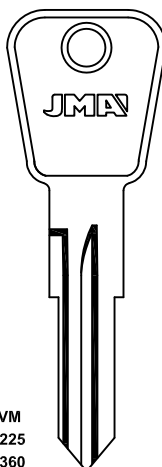

FV-VM  
101-225  
301-360  
VT...  
400-474



**LF-6**

CHRYSLER-VAUXHALL-BEDFORD-FORD

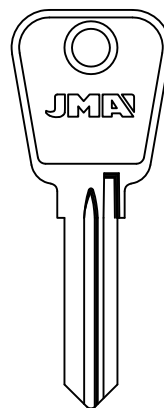

....  
66001-67200



**LF-7**

FORD EUROPA

....  
81001-87000



**LF-7D**



**PARA-FOR:**  
**LOWE & FLETCHER**  
 (GB)

**LOWE & FLETCHER**

93...201-400  
.....93901-94000

**LF-8**

**LF-8D**

93...401-900  
.....90901-90975

**LF-11**

**LF-11D**

**EURO LOCKS-MIBRA-UTZ**

15001-19000  
85001-87000

**LF-9**

**ROVER-BEDFORD  
BRITAX**

60... 001-200  
60... 001-200  
90... 001-200  
...1-400  
GHM...1-155  
M...1-400  
RV...1-400  
RVM...1-400  
SP...1-400  
99...1-400

**LF-15**

FFE  
001-100

**LF-17**

**CEM-EURO LOCKS-ULTRA-UNION**

**LOWE & FLETCHER**

**LF-28**

**EURO LOCKS**

**LF-39D**

**EURO LOCKS**

BL....  
BL....N  
1001-2000

**LF-BL**

**BRITAX**

AUSTIN  
CARBODIES  
INNOCENTI  
LAND ROVER  
LOTUS  
MASERATI  
OM IVECO  
ROVER  
VAUXHALL  
BEDFORD  
FIAT IVECO

RO  
BL....N  
1001-2000

**LF-RO**

**LOWE & FLETCHER**

AUSTIN  
CARBODIES  
INNOCENTI  
LAND ROVER  
LOTUS  
MASERATI  
OM IVECO  
ROVER  
VAUXHALL  
BEDFORD  
FIAT IVECO

RO  
BL....N  
1001-2000

**LF-RO.P**

SL  
5001-7000

**LF-SL**

**CHRYSLER-FORD (USA)-SUNBEAM  
ROOTES**

SL  
5001-7000

**LF-SL.P**

**CHRYSLER-FORD (USA)-SUNBEAM  
ROOTES**

WR  
1001-2000

**LF-WB**

**TRIUMPH  
WILMOT BREEDEN**





**LOWE & FLETCHER**

**MACK**

**MARUTI**

**PARA-FOR:**

LOWE & FLETCHER (GB)

MACK (USA)

MARUTI (IND)

MAZDA (J)

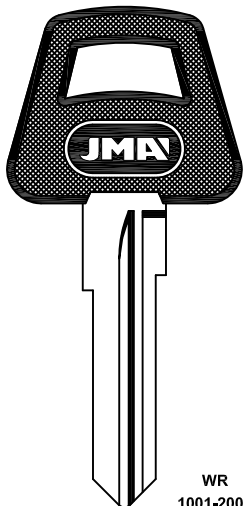

WR  
1001-2000  
**LF-WB.P**

TRIUMPH  
WILMOT BREEDEN

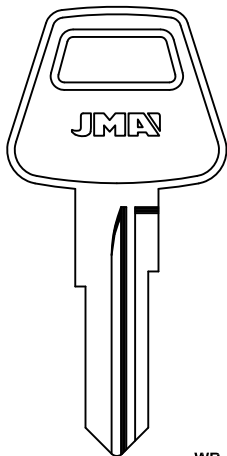

WR  
3000-3999  
5000-5999  
**LF-WR**

DE LOREAN-FORD (USA)  
WILMOT BREEDEN

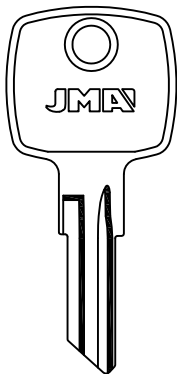

LAT.



**MAK-1**

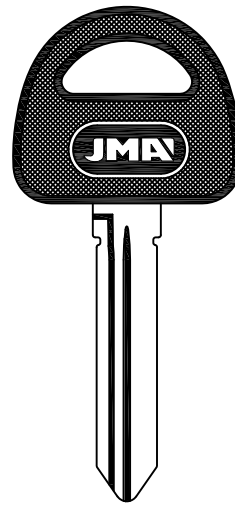

**MAR-1.P**

**MAZDA**

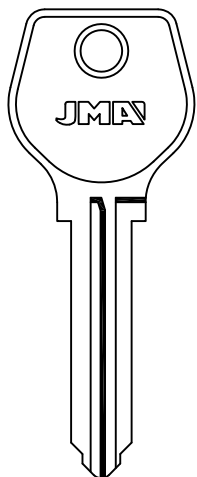

1500-1999  
2000-2499 5000-6100

**MAZ-1I** **MAZ-1D**  
FORD (USA)-MAZDA

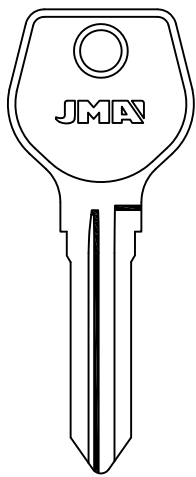

3000-3499 2500-2999  
5000-6100 3500-4600

**MAZ-2I** **MAZ-2D**  
FORD (AUSTRALIA)-MAZDA

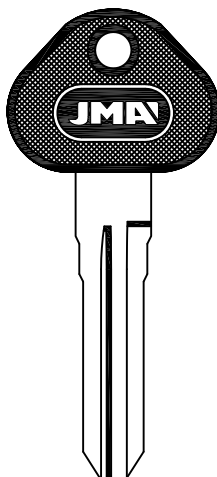

3000-3499 2500-2999  
5000-6100 3500-4600

**MAZ-2I.P** **MAZ-2D.P**  
FORD (AUSTRALIA)-MAZDA

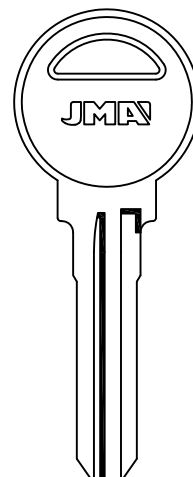

6500-7733

**MAZ-3I** **MAZ-3D**  
MAZDA

**MAZDA**

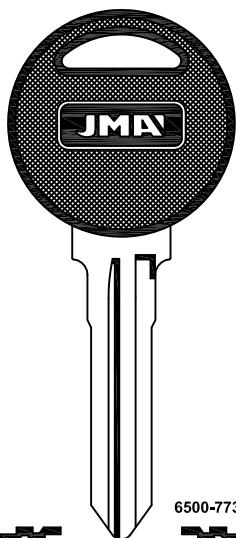

6500-7733  
**MAZ-3I.P** **MAZ-3D.P**  
MAZDA

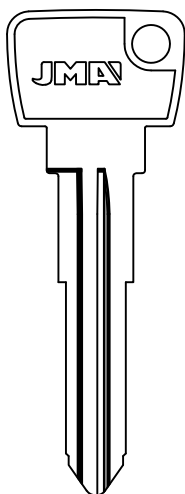

**MAZ-4**  
MAZDA

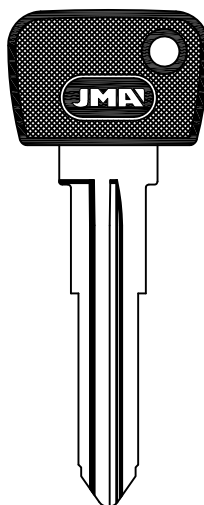

**MAZ-4.P**  
MAZDA

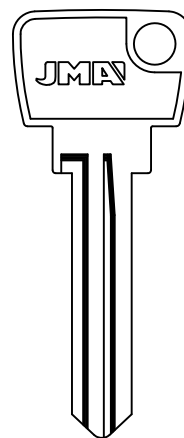

FA....  
6500-7733  
**MAZ-5D**  
MAZDA



PARA-FOR:

MAZDA (J)

MAZDA

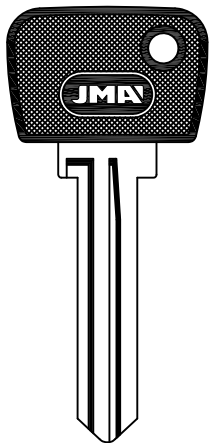

FA...  
6500-7733



MAZDA

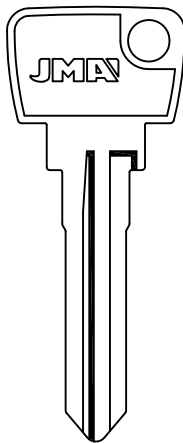

....  
6500-7733



MAZ-6

FORD (USA)-MAZDA

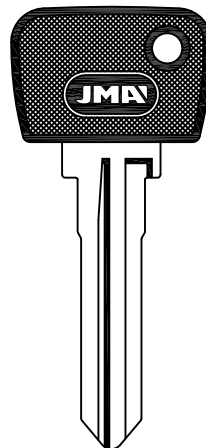

....  
6500-7733



MAZ-6.P

FORD (USA)-MAZDA

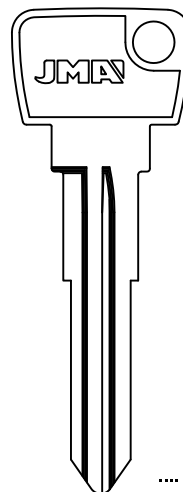

....  
10100-12099



MAZ-7D

MAZDA

MAZDA

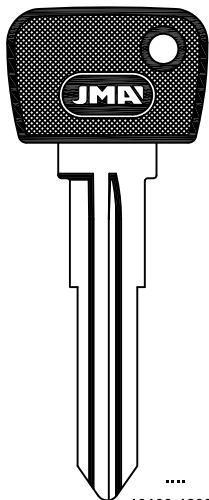

....  
10100-12099



MAZ-7D.P

MAZDA

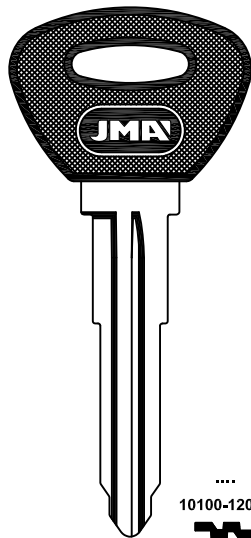

....  
10100-12099



MAZ-7D.P1

MAZDA

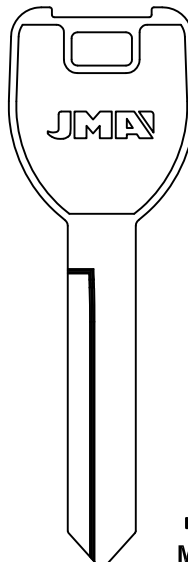

...A...  
101-291  
501-579  
...B...  
101-332  
501-602  
...C...  
101-344  
501-624  
...D...  
101-327  
501-602  
...E...  
101-296  
501-579



MAZ-8D

MAZDA

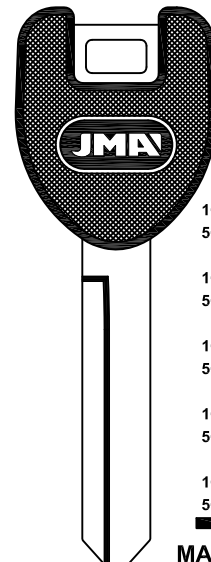

...A...  
101-291  
501-579  
...B...  
101-332  
501-602  
...C...  
101-344  
501-624  
...D...  
101-327  
501-602  
...E...  
101-296  
501-579



MAZ-8D.P

MAZDA

MAZDA

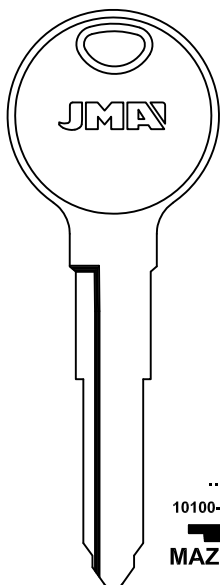

....  
10100-12099



MAZ-11D

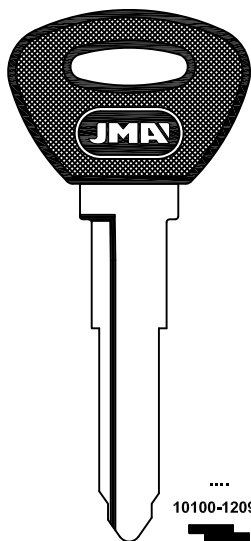

....  
10100-12099



MAZ-11D.P1

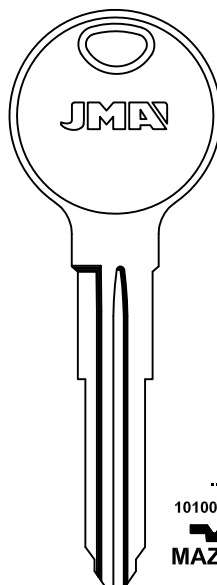

....  
10100-12099



MAZ-13D

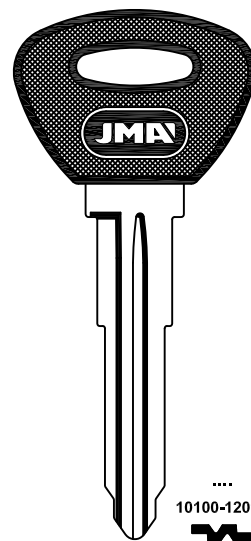

....  
10100-12099



MAZ-13D.P



# MAZDA

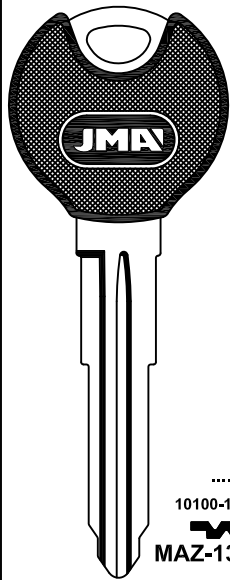

....  
10100-12099  
  
MAZ-13D.P1

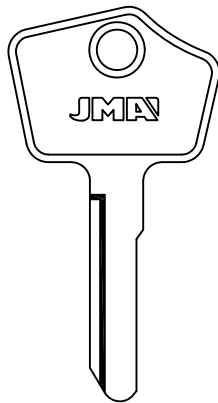

...002-989  
  
MAZ-14D

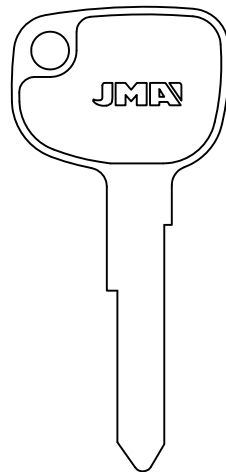

MAZ-15D

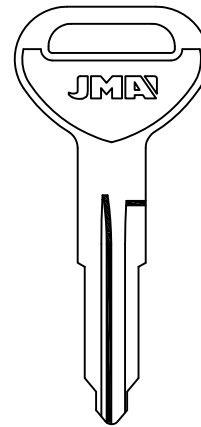

M....  
1-3392  
  
MAZ-16

# PARA-FOR:

- MAZDA (J)
- MERIT-LINDE (D)
- MISCELLANEOUS
- MITSUBISHI (J)

## MAZDA

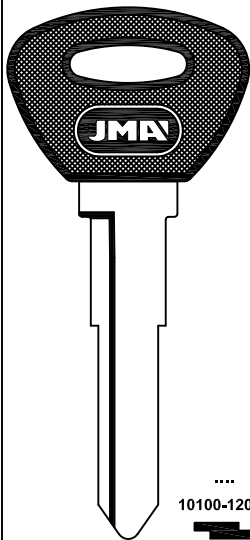

....  
10100-12099  
  
MAZ-21D.P1

## MERIT-LINDE

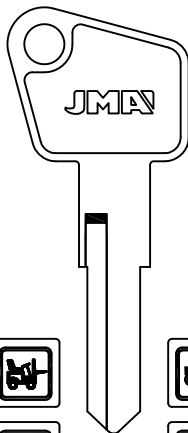

MERI-1D

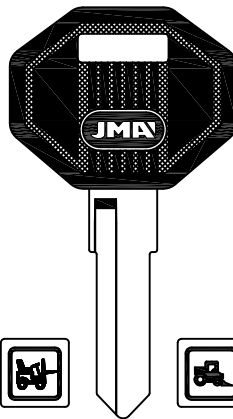

MERI-1D.P

## MISCELLANEOUS

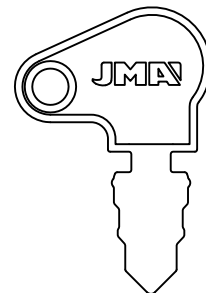

LAT.

MIS-1

## MITSUBISHI

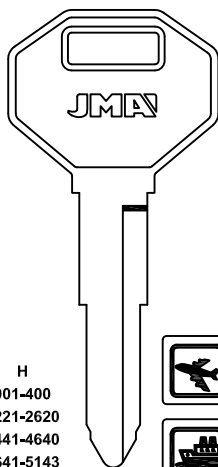

H  
001-400  
2221-2620  
4441-4640  
4641-5143  
E  
2001-3000  
  
MIT-11



MIT-1D

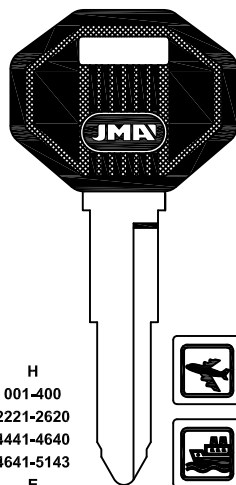

H  
001-400  
2221-2620  
4441-4640  
4641-5143  
E  
2001-3000  
  
MIT-11.P



MIT-1D.P

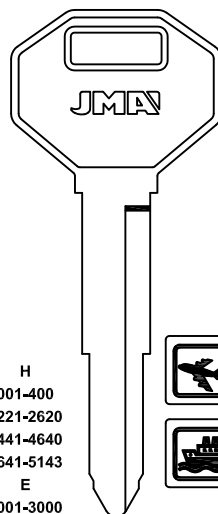

H  
001-400  
2221-2620  
4441-4640  
4641-5143  
E  
2001-3000  
  
MIT-2I



MIT-2D

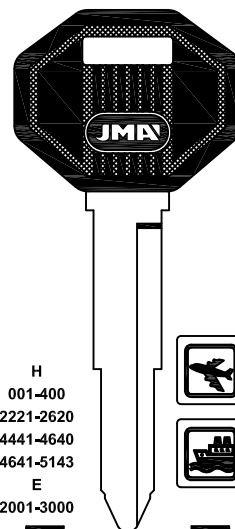

H  
001-400  
2221-2620  
4441-4640  
4641-5143  
E  
2001-3000  
  
MIT-2D.P



MIT-2D.P

CHRYSLER-HOLDEN-HSUZU-MITSUBISHI

CHRYSLER-GM-HYUNDAI-HSUZU  
MITSUBISHI-SUZUKI



PARA-FOR:  
MITSUBISHI (J)

MITSUBISHI

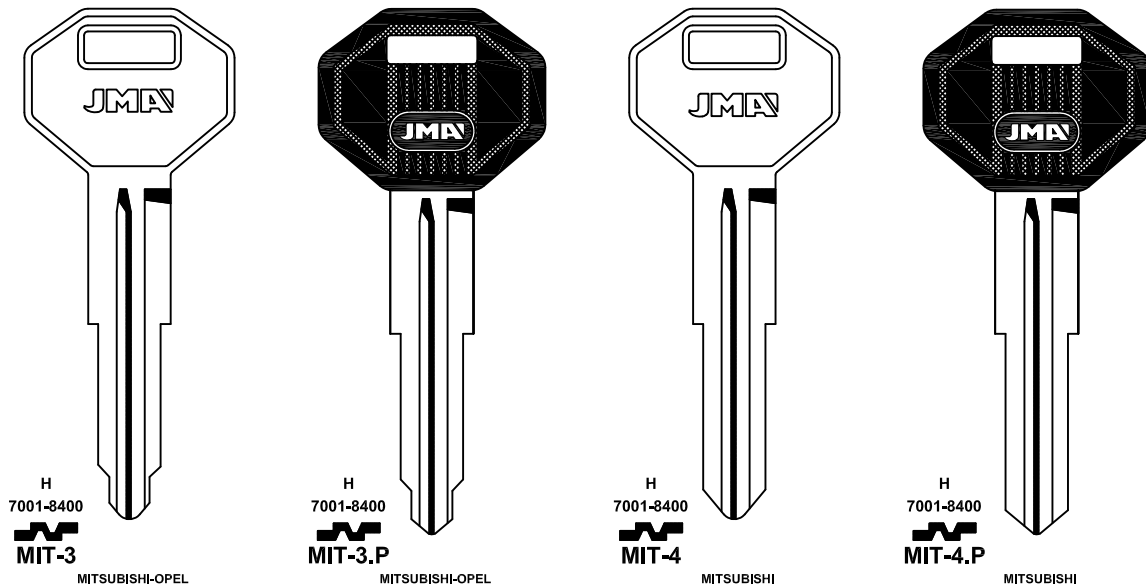

MITSUBISHI

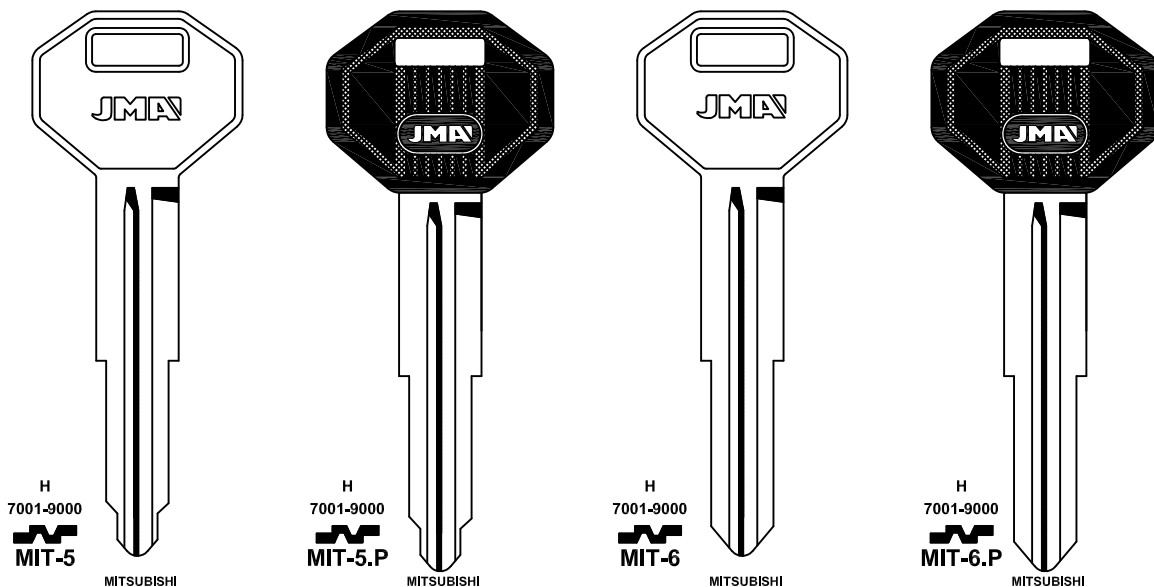

MITSUBISHI

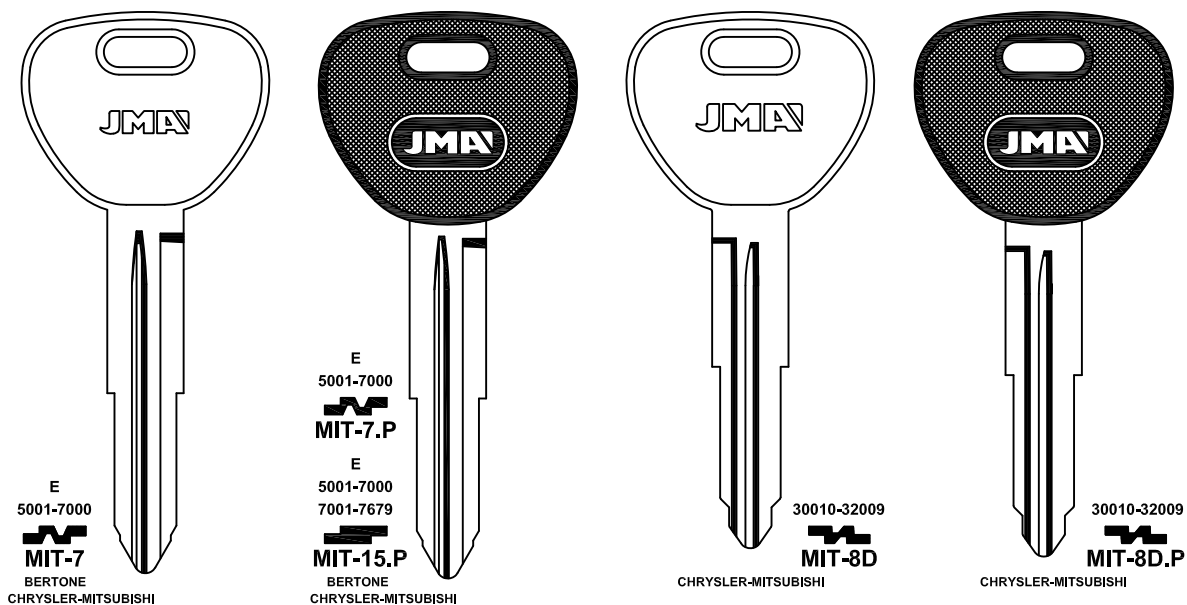

## MITSUBISHI

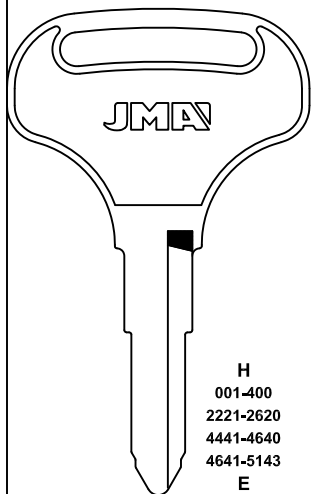

H  
001-400  
2221-2620  
4441-4640  
4641-5143  
E  
2001-3000



MITSUBISHI

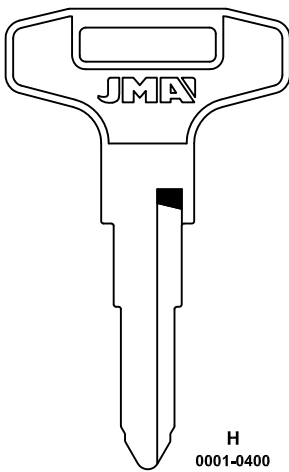

H  
0001-0400  
2221-2620  
4441-5143



MITSUBISHI

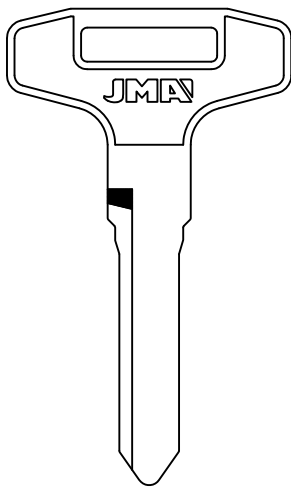

8100-9113



MITSUBISHI

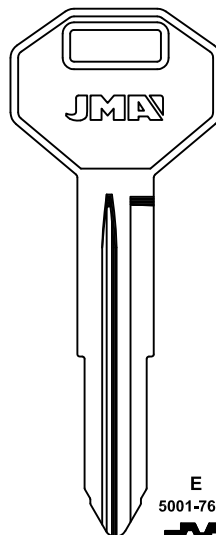

E  
5001-7679



BERTONE-CHRYSLER-MITSUBISHI

## PARA-FOR:

MITSUBISHI (J)

MONDIAL (F)

MOSKVITCH (RUS)

NEIMAN (F)

## MITSUBISHI

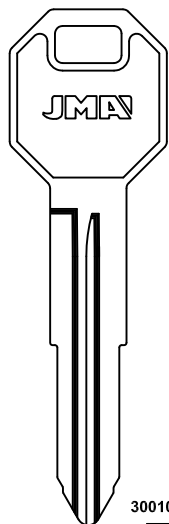

30010-32009



MIT-13D

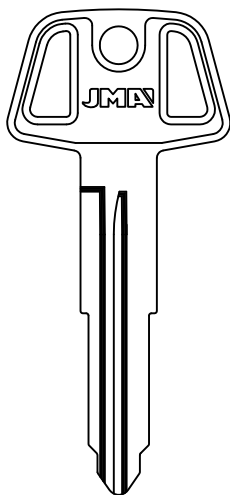

30010-32009



MIT-14D

CHRYSLER-MITSUBISHI

## MONDIAL

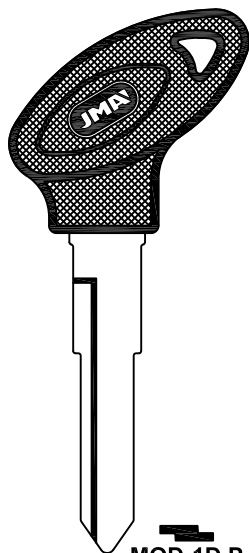

MOD-1D.P

## MOSKVITCH

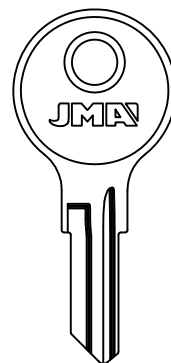

MOS-1

## NEIMAN

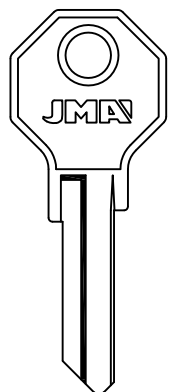

41-4/4

RENAULT

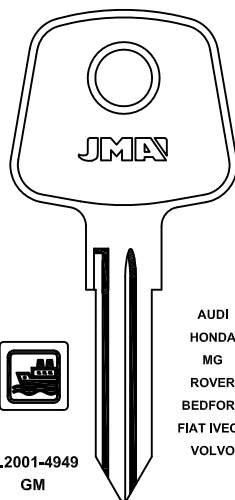

....2001-4949

GM

....2001-3000

NE-1

CLAUSOR

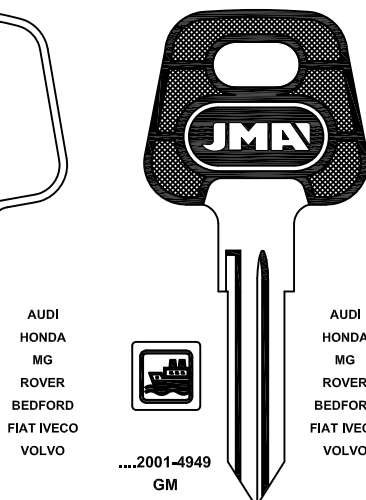

AUDI  
HONDA  
MG  
ROVER  
BEDFORD  
FIAT IVECO  
VOLVO

....2001-4949

GM

....2001-3000

NE-1.P

CLAUSOR

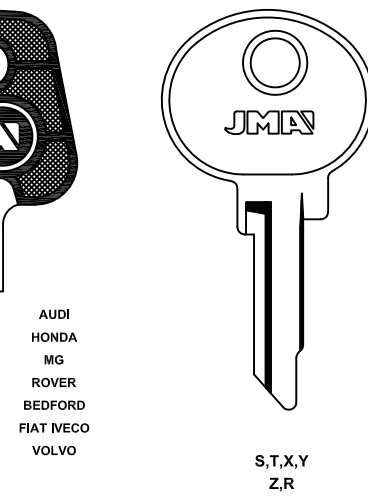

AUDI  
HONDA  
MG  
ROVER  
BEDFORD  
FIAT IVECO  
VOLVO

NE-1D.P

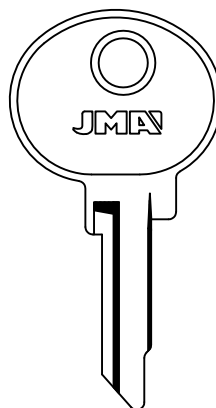

S,T,X,Y

Z,R

1-2-3-5-7

NE-2

CLAUSOR

**JMA**<sup>®</sup>

Copyright by Alejandro Altuna S.A. 2014



ATENCIÓN: Concerniente a las marcas y denominaciones comerciales ver nota en índice.

ATTENTION: Concerning the marks and commercial denominations see note in index.

ATTENTION: Concernant les marques et dénominations commerciales voir la note dans l'index.

ACHTUNG: Beziehen auf die marke und handelsname sehen sie die notiz im index.

**PARA-FOR:**  
NEIMAN (F)

**NEIMAN**

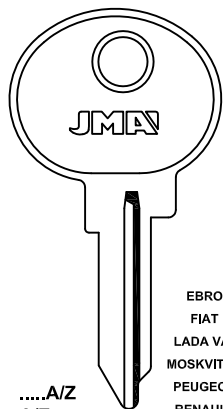

.....A/Z  
A/Z.....  
A/Z.....A/Z  
1 AL 7  
.....A/Z  
0 AL 9



**NE-3**

CLAUSOR

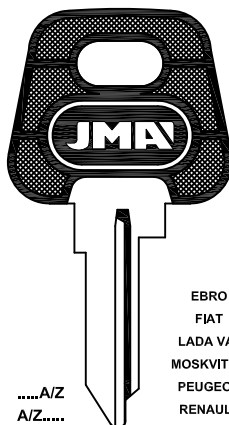

.....A/Z  
A/Z.....  
A/Z.....A/Z  
1 AL 7  
.....A/Z  
0 AL 9



**NE-3.P**

CLAUSOR

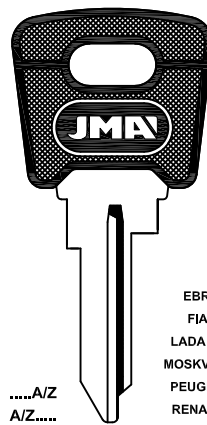

.....A/Z  
A/Z.....  
A/Z.....A/Z  
1 AL 7  
.....A/Z  
0 AL 9



**NE-3.P1**

CLAUSOR

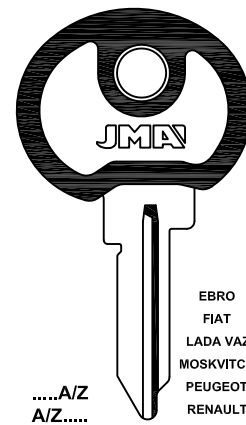

.....A/Z  
A/Z.....  
A/Z.....A/Z  
1 AL 7  
.....A/Z  
0 AL 9



**NE-3.P2**

CLAUSOR

**NEIMAN**

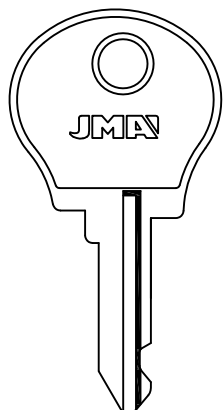

.A/Z.....  
.A/Z.....A/Z  
A/Z.....A/Z  
0 AL 8  
1 AL 7  
A/Z.....1 AL 7 Y A AL E



**NE-4**

11-34-39....  
1 AL 7  
34-39....A/Z  
1 AL 7



**NE-15I**

ACM-ARO DACIA-CITROEN-FIAT-RENAULT  
CLAUSOR

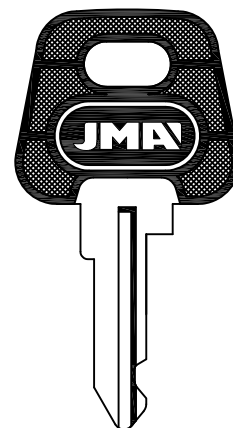

.A/Z.....  
.A/Z.....A/Z  
A/Z.....A/Z  
0 AL 8  
1 AL 7  
A/Z.....1 AL 7 Y A AL E



**NE-4.P**

11-34-39....  
1 AL 7  
34-39....A/Z  
1 AL 7



**NE-15I.P**

ACM-ARO DACIA-CITROEN-FIAT-RENAULT  
CLAUSOR

**NEIMAN**

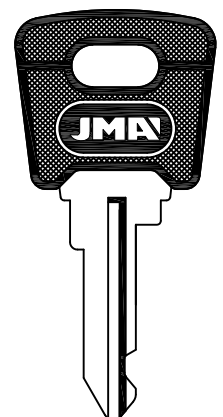

.A/Z.....  
.A/Z.....A/Z  
A/Z.....A/Z  
0 AL 8  
1 AL 7  
A/Z.....1 AL 7 Y A AL E



**NE-4.P1**

11-34-39....  
1 AL 7  
34-39....A/Z  
1 AL 7



**NE-15I.P1**

ACM-ARO DACIA-CITROEN-FIAT-RENAULT  
CLAUSOR

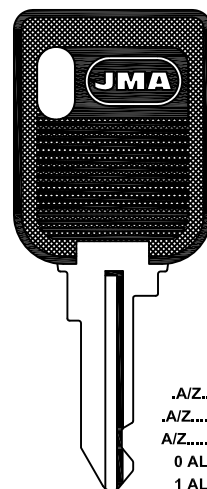

.A/Z.....  
.A/Z.....A/Z  
A/Z.....A/Z  
0 AL 8  
1 AL 7  
A/Z.....1 AL 7 Y A AL E



**NE-4.P2**

RENAULT  
CLAUSOR

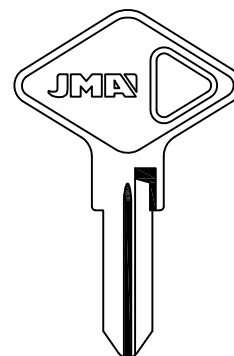

CLAUSOR





## NEIMAN

PARA-FOR:  
NEIMAN (F)

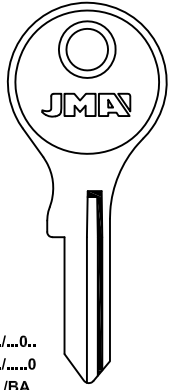

.0.../...0..  
....0/....0  
AA.../BA...  
CA.../EA...  
Z.../Z...  
..Z.../..Z...  
...Z.../...Z...  
1 AL 5



**NE-6**

VARIAS MARCAS DE MOTOS

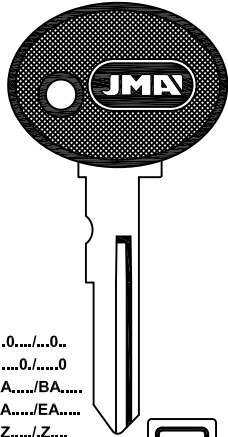

.0.../...0..  
....0/....0  
AA.../BA...  
CA.../EA...  
Z.../Z...  
..Z.../..Z...  
...Z.../...Z...  
1 AL 5



**NE-6.P**

VARIAS MARCAS DE MOTOS

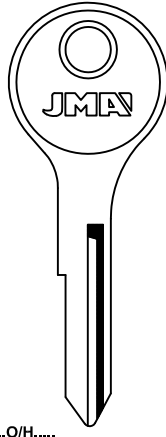

....O/H....  
..H.../..H...  
...H.../...H...  
1 AL 5

**NE-7**

BMW

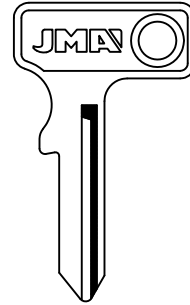

.0.../...0...  
....0/0....0  
AA.../BA...  
CA...  
1 AL 5

**NE-8**

VARIAS MARCAS DE MOTOS  
CLAUSOR

## NEIMAN

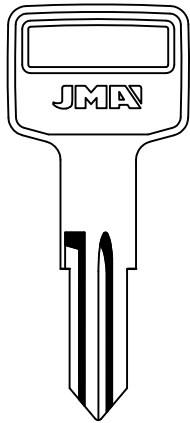

....6250-6499

**NE-9**

VOLVO  
CLAUSOR

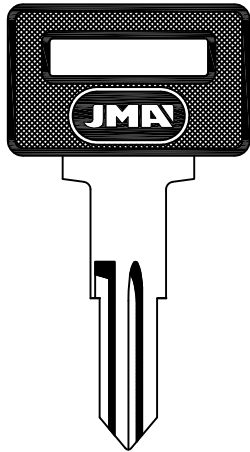

....6250-6499

**NE-9.P**

VOLVO  
CLAUSOR

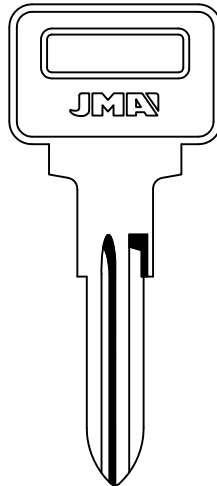

....7001-9000

**NE-10**

DE LOREAN-MG-VOLVO-BEDFORD

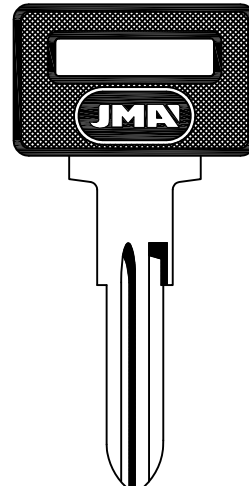

....7001-9000

**NE-10.P**

DE LOREAN-MG-VOLVO-BEDFORD

## NEIMAN

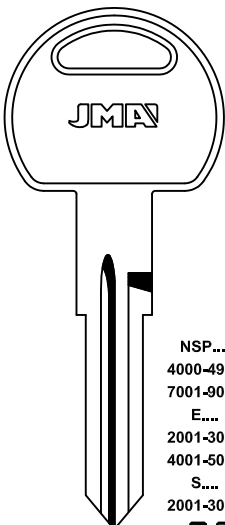

NSP...  
4000-4999  
7001-9000  
E...  
2001-3000  
4001-5000  
S...  
2001-3000

**NE-11**

FORD-NISSAN-ROVER-STERLING  
DAF-KENWORTH

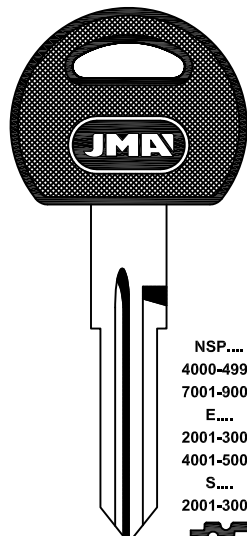

NSP...  
4000-4999  
7001-9000  
E...  
2001-3000  
4001-5000  
S...  
2001-3000

**NE-11.P**

FORD-NISSAN-ROVER-STERLING  
DAF-KENWORTH

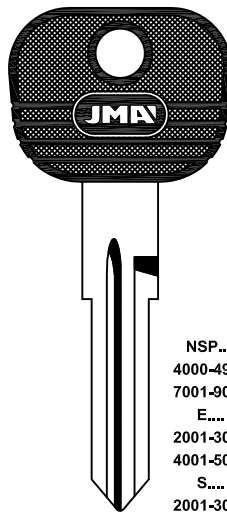

NSP...  
4000-4999  
7001-9000  
E...  
2001-3000  
4001-5000  
S...  
2001-3000

**NE-11.P1**

LAND RANGE ROVER-ROVER

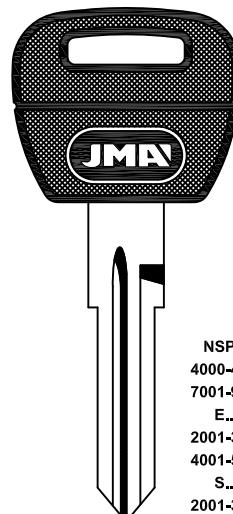

NSP...  
4000-4999  
7001-9000  
E...  
2001-3000  
4001-5000  
S...  
2001-3000

**NE-11.P2**

ROVER

**JMA**<sup>®</sup>

Copyright by Alejandro Altuna S.A. 2014





ATENCIÓN: Concerniente a las marcas y denominaciones comerciales ver nota en índice.  
ATTENTION: Concerning the marks and commercial denominations see note in index.  
ATTENTION: Concernant les marques et dénominations commerciales voir la note dans l'index.  
ACHTUNG: Beziehen auf die marke und handelsname sehen sie die notiz im index.



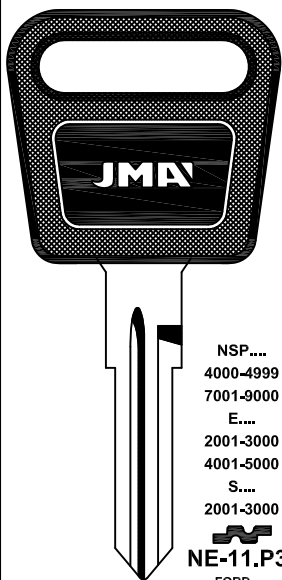

PARA-FOR:  
NEIMAN (F)

NEIMAN

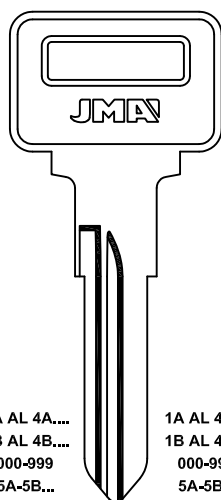

NSP....  
4000-4999  
7001-9000  
E....  
2001-3000  
4001-5000  
S....  
2001-3000  
  
**NE-11.P3**  
FORD



1A AL 4A....  
1B AL 4B....  
000-999  
5A-5B...  
000-746  
  
**NE-12**  
VOLVO

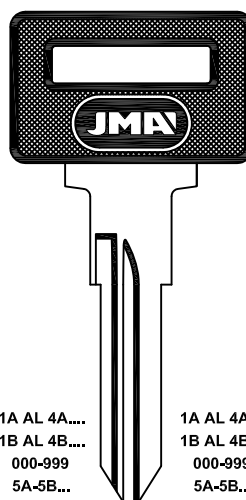

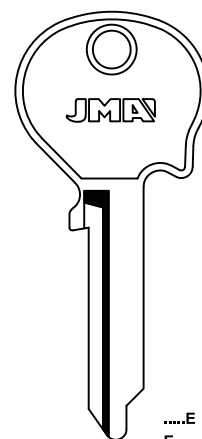

1A AL 4A....  
1B AL 4B....  
000-999  
5A-5B...  
000-746  
  
**NE-12.P**  
VOLVO



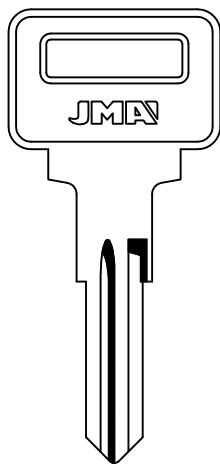

....E  
E....  
N....  
X....  
1 AL 5  
  
**NE-13**  
VOLVO

NEIMAN

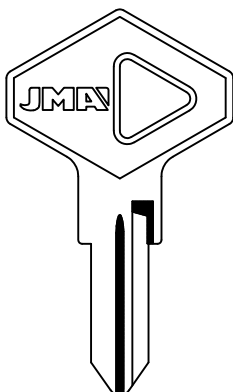

NP....  
1-1000  
  
**NE-14**  
ROVER  
CEM



T...001-999  
V...000-922  
2.....  
2.....A/Z  
B-C-D-E-G  
  
**NE-16**  
AMERICAN MOTORS-RENAULT  
CLAUSOR

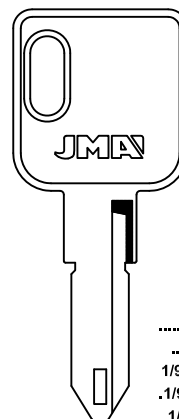

....1/9..A/Z  
..1/9....  
1/9.....A/Z  
.1/9.....A/Z  
..1/9.....A/Z  
...1/9...A/Z  
....1/9..A/Z  
.....1/9..A/Z  
M-N-P-R-S  
  
**NE-19**  
AMERICAN MOTORS-CHRYSLER-PEUGEOT  
RENAULT

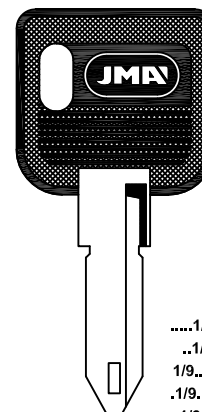

....1/9..A/Z  
..1/9....  
1/9.....A/Z  
.1/9.....A/Z  
..1/9.....A/Z  
...1/9...A/Z  
....1/9..A/Z  
.....1/9..A/Z  
M-N-P-R-S  
  
**NE-19.P**  
RENAULT

NEIMAN

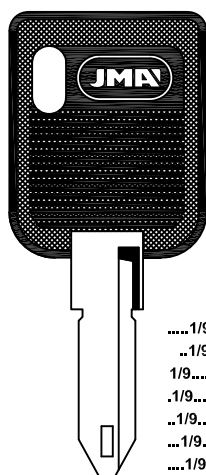

....1/9..A/Z  
..1/9....  
1/9.....A/Z  
.1/9.....A/Z  
..1/9.....A/Z  
...1/9...A/Z  
....1/9..A/Z  
.....1/9..A/Z  
M-N-P-R-S  
  
**NE-19.P1**  
RENAULT

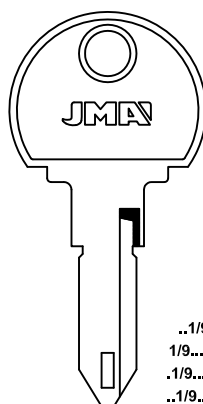

..1/9....  
1/9.....A/Z  
.1/9.....A/Z  
..1/9.....A/Z  
...1/9...A/Z  
....1/9..A/Z  
.....1/9..A/Z  
M-N-P-R-S  
  
**NE-20**  
PEUGEOT

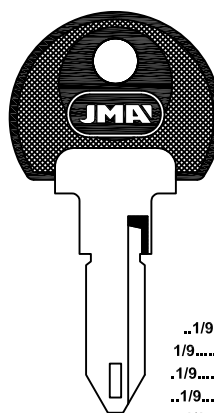

..1/9....  
1/9.....A/Z  
.1/9.....A/Z  
..1/9.....A/Z  
...1/9...A/Z  
....1/9..A/Z  
.....1/9..A/Z  
M-N-P-R-S  
  
**NE-20.P**  
PEUGEOT

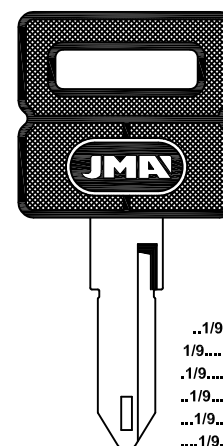

..1/9....  
1/9.....A/Z  
.1/9.....A/Z  
..1/9.....A/Z  
...1/9...A/Z  
....1/9..A/Z  
.....1/9..A/Z  
M-N-P-R-S  
  
**NE-20.P1**  
PEUGEOT



# NEIMAN

PARA-FOR:  
NEIMAN (F)

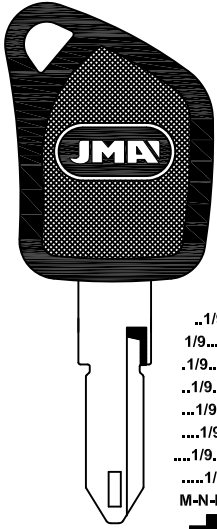

..1/9....  
1/9....A/Z  
.1/9....A/Z  
..1/9....A/Z  
...1/9...A/Z  
....1/9..A/Z  
.....1/9..A/Z  
M-N-P-R-S

**NE-20.P2**

PEUGEOT

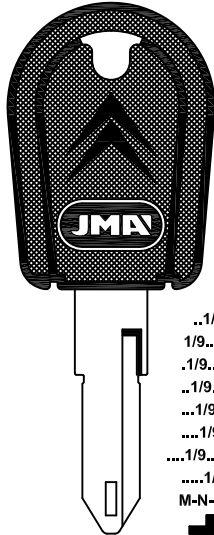

..1/9....  
1/9....A/Z  
.1/9....A/Z  
..1/9....A/Z  
...1/9...A/Z  
....1/9..A/Z  
.....1/9..A/Z  
M-N-P-R-S

**NE-20.P3**

CITROEN

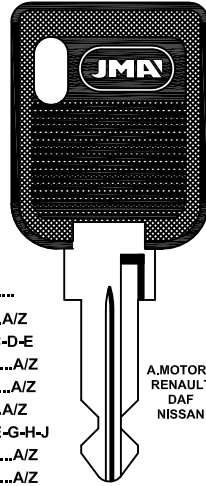

.....  
.....A/Z  
B-C-D-E  
1/9....A/Z  
1/9....A/Z  
.....A/Z  
B-D-E-G-H-J  
.1/9....A/Z  
.1/9....A/Z  
E-M-N-P-R

**NE-22.P**

CLAUSOR

A.MOTORS  
RENAULT  
DAF  
NISSAN

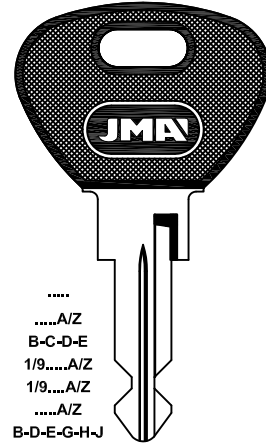

.....  
.....A/Z  
B-C-D-E  
1/9....A/Z  
1/9....A/Z  
.....A/Z  
B-D-E-G-H-J  
.1/9....A/Z  
.1/9....A/Z  
E-M-N-P-R

**NE-22.P1**

CITROEN-PEUGEOT-PEGASO  
CLAUSOR

# NEIMAN

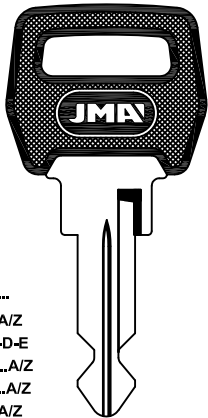

.....  
.....A/Z  
B-C-D-E  
1/9....A/Z  
1/9....A/Z  
.....A/Z  
B-D-E-G-H-J  
.1/9....A/Z  
.1/9....A/Z  
E-M-N-P-R

**NE-22.P2**

MAZDA-TALBOT SIMCA-DAF  
CLAUSOR

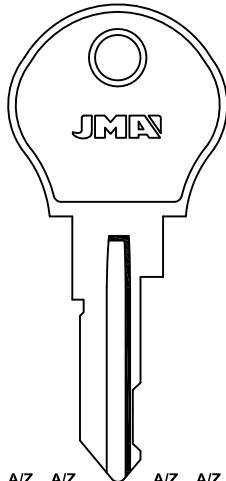

A/Z....A/Z  
0-4-6-8-9

**NE-23**

MAZDA  
DATSUN

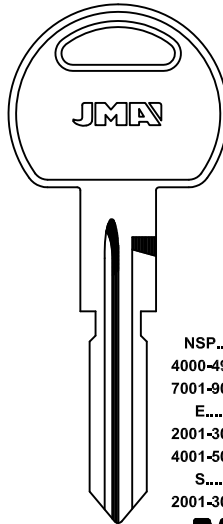

NSP....  
4000-4999  
7001-9000  
E....  
2001-3000  
4001-5000  
S....  
2001-3000

**NE-24**

FORD-ROVER-STERLING

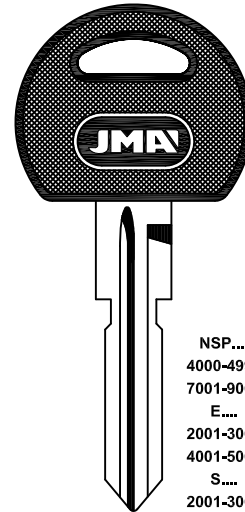

NSP....  
4000-4999  
7001-9000  
E....  
2001-3000  
4001-5000  
S....  
2001-3000

**NE-24.P**

FORD-ROVER-STERLING

# NEIMAN

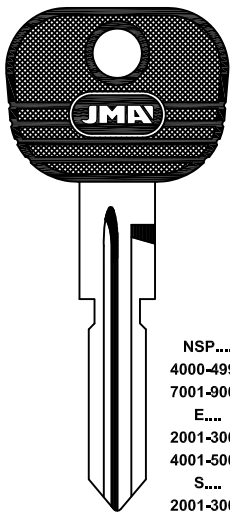

NSP....  
4000-4999  
7001-9000  
E....  
2001-3000  
4001-5000  
S....  
2001-3000

**NE-24.P1**

LAND RANGE ROVER-ROVER

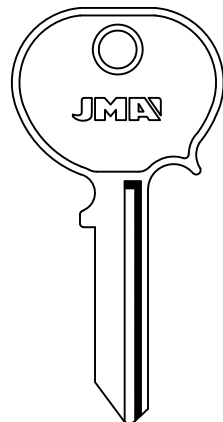

.....A  
.....D  
.....F  
1 AL 5

**NE-25**

ALFA ROMEO-FERRARI-STEYR PUCH

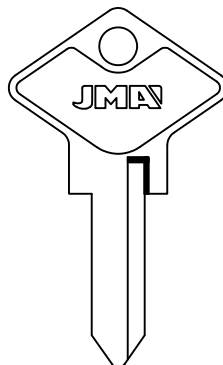

**NE-27**

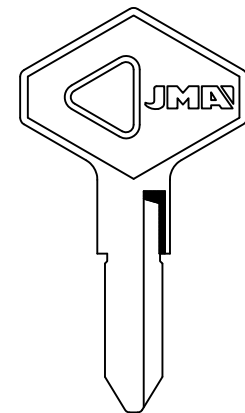

..1/9....A/Z  
M-N-P-R-S

**NE-28**

CHRYSLER (EAGLE)-RENAULT



PARA-FOR:  
NEIMAN (F)

NEIMAN

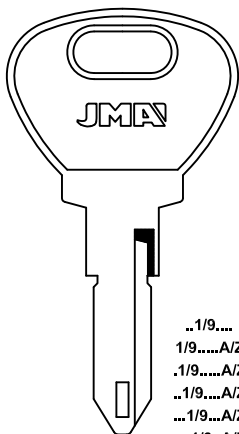

..1/9....  
1/9....A/Z  
.1/9....A/Z  
..1/9....A/Z  
...1/9....A/Z  
....1/9..A/Z  
....1/9..A/Z A/Z  
.....1/9.A/Z  
.....1/9.A/Z  
M-N-P-R-S  
  
**NE-29**

PEUGEOT

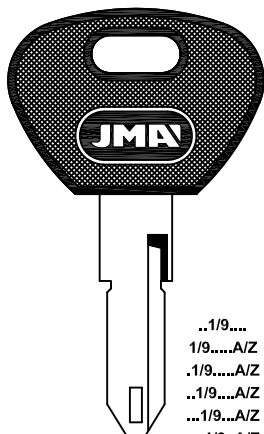

..1/9....  
1/9....A/Z  
.1/9....A/Z  
..1/9....A/Z  
...1/9....A/Z  
....1/9..A/Z  
....1/9..A/Z A/Z  
.....1/9.A/Z  
.....1/9.A/Z  
M-N-P-R-S  
  
**NE-29.P**

PEUGEOT

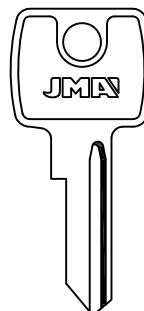

....  
5001-6278

  
**NE-30**

BASTA

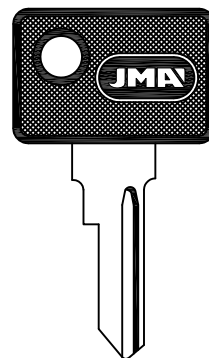

....  
5001-6278

  
**NE-30.P**

BASTA

NEIMAN

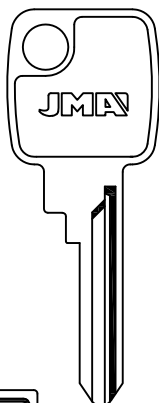

..1/9....A/Z  
M-N-P-R-S

  
**NE-31**

BASTA

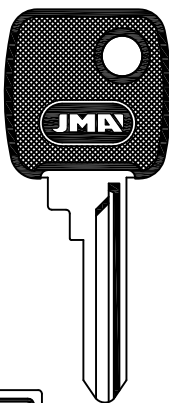

..1/9....A/Z  
M-N-P-R-S

  
**NE-31.P**

BASTA

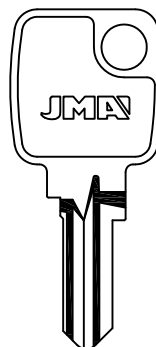

.B...3-5-7-L  
..B...3-5-7-L/2-3-5-7-L  
...B...3-5-7-L  
....B...3-5-7-L

  
**NE-32**

BASTA

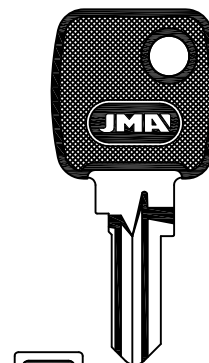



.B...3-5-7-L  
..B...3-5-7-L/2-3-5-7-L  
...B...3-5-7-L  
....B...3-5-7-L

  
**NE-32.P**

BASTA

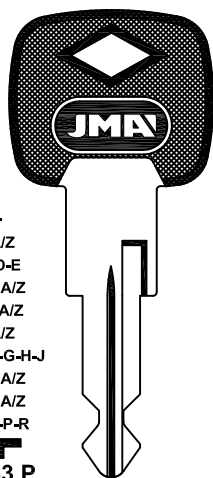
NEIMAN



.....  
....A/Z  
B-C-D-E  
1/9....A/Z  
1/9....A/Z  
....A/Z  
B-D-E-G-H-J  
.1/9....A/Z  
.1/9....A/Z  
E-M-N-P-R  
  
**NE-33.P**

  
**NE-44.P**

RENAULT  
CLAUSOR

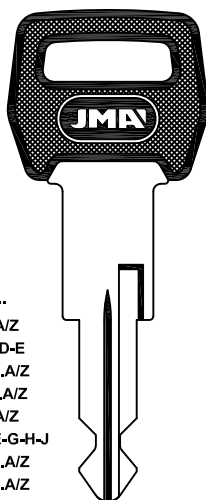

.....  
....A/Z  
B-C-D-E  
1/9....A/Z  
1/9....A/Z  
....A/Z  
B-D-E-G-H-J  
.1/9....A/Z  
.1/9....A/Z  
E-M-N-P-R  
  
**NE-33.P1**

**NE-33.P1**

TALBOT SIMCA  
CLAUSOR

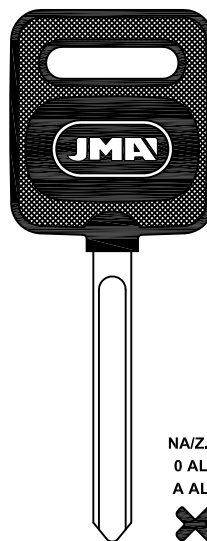

LAT.

NA/Z.....  
0 AL 9  
A AL F

  
**NE-34.P**

PEUGEOT

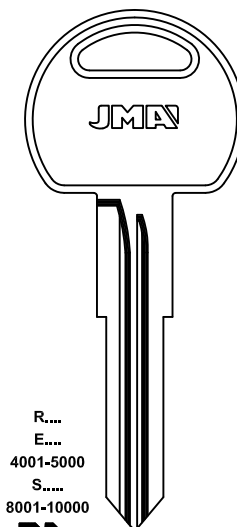

R....  
E....  
4001-5000  
S.....  
8001-10000

  
**NE-35**

HONDA-ROVER



# NEIMAN

PARA-FOR:  
NEIMAN (F)

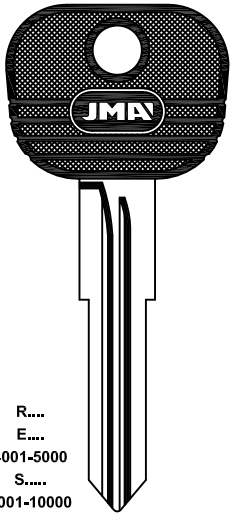

R....  
E....  
4001-5000  
S....  
8001-10000

**NE-35.P**

ROVER

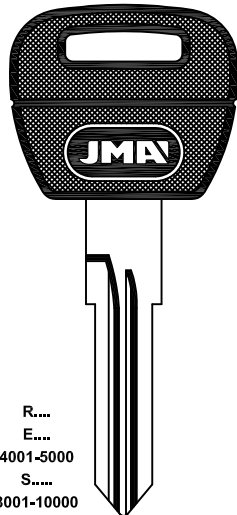

R....  
E....  
4001-5000  
S....  
8001-10000

**NE-35.P2**

HONDA-ROVER

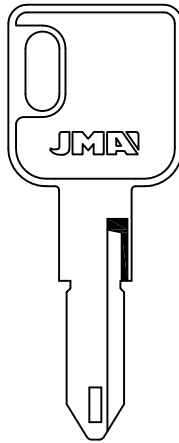

..1/9....  
1/9....A/Z  
.1/9....A/Z  
..1/9....A/Z  
...1/9....A/Z  
....1/9....A/Z  
.....1/9..A/Z A/Z  
M-N-P-R-S

**NE-36**

CITROEN-PEUGEOT-RENAULT

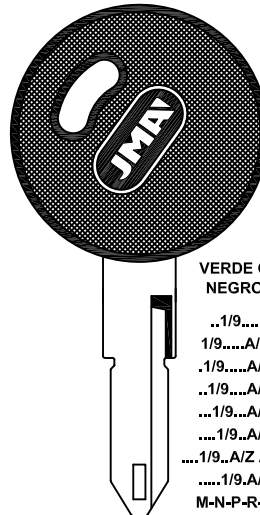

VERDE O  
NEGRO

..1/9....  
1/9....A/Z  
.1/9....A/Z  
..1/9....A/Z  
...1/9....A/Z  
....1/9....A/Z  
.....1/9..A/Z A/Z  
M-N-P-R-S

**NE-36.P**

RENAULT

# NEIMAN

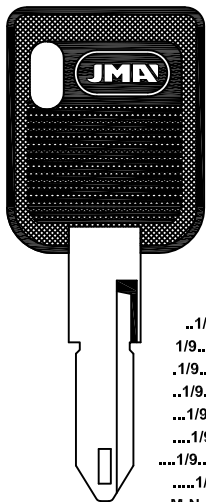

..1/9....  
1/9....A/Z  
.1/9....A/Z  
..1/9....A/Z  
...1/9....A/Z  
....1/9..A/Z A/Z  
.....1/9..A/Z  
M-N-P-R-S

**NE-36.P1**

CITROEN-PEUGEOT-RENAULT

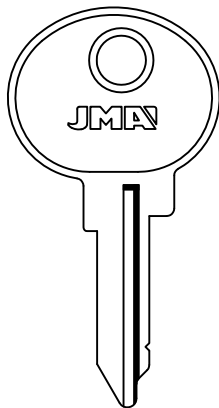

....A/Z  
1-2-3-5-7

**NE-37**

PEUGEOT

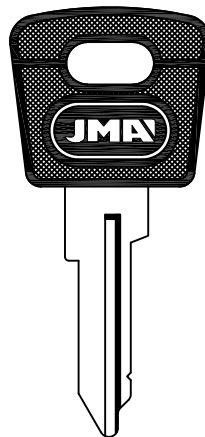

....A/Z  
1-2-3-5-7

**NE-37.P**

PEUGEOT

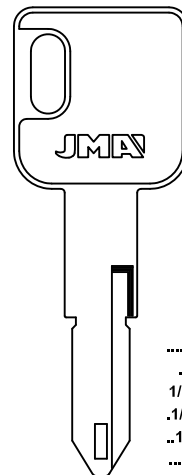

.....1/9..A/Z  
..1/9....  
1/9....A/Z  
.1/9....A/Z  
..1/9....A/Z  
...1/9....A/Z  
....1/9..A/Z  
.....1/9..A/Z A/Z

**NE-38**

RENAULT

# NEIMAN

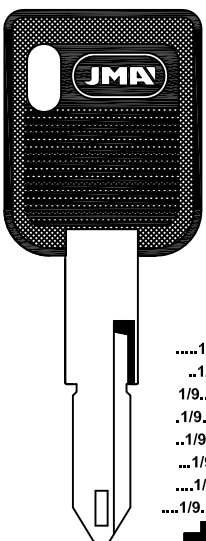

.....1/9..A/Z  
..1/9....  
1/9....A/Z  
.1/9....A/Z  
..1/9....A/Z  
...1/9....A/Z  
....1/9..A/Z  
.....1/9..A/Z A/Z

**NE-38.P1**

RENAULT

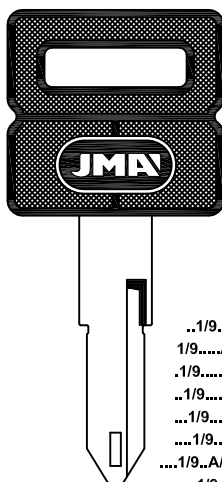

..1/9....  
1/9....A/Z  
.1/9....A/Z  
..1/9....A/Z  
...1/9....A/Z  
....1/9..A/Z  
.....1/9..A/Z A/Z  
M-N-P-R-S

**NE-39.P**

PEUGEOT

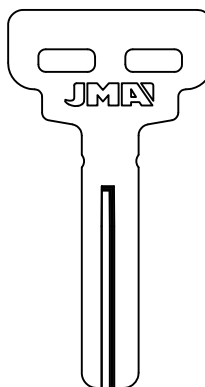

LAT.

7,5  
3

**NE-40**

VOLVO  
YMOS

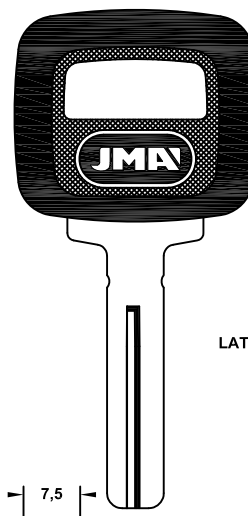

LAT.

7,5  
3

**NE-40.P**

VOLVO  
YMOS



PARA-FOR:  
NEIMAN (F-RA)

NEIMAN

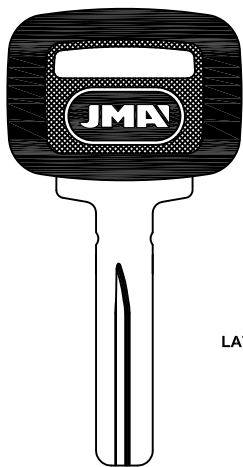

7,5  
3  
NE-41.P  
VOLVO  
YMOS

LAT.

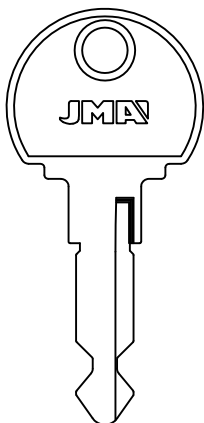

NE-42  
PEUGEOT

NEIMAN (RA)

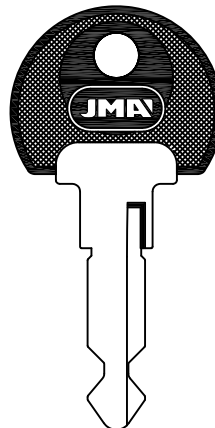

NE-42.P  
PEUGEOT

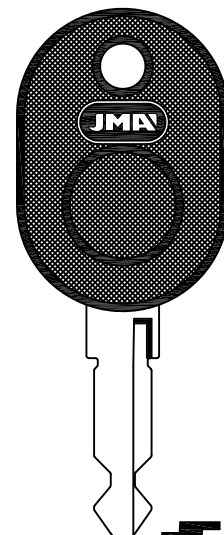

NE-42.P1  
PEUGEOT

NEIMAN (RA)

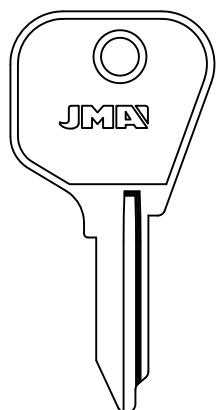

NE-43  
PEUGEOT

NEIMAN

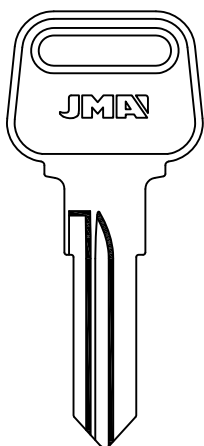

NE-45  
PEUGEOT

NEIMAN (RA)

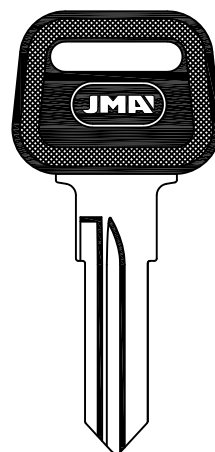

NE-45.P  
PEUGEOT

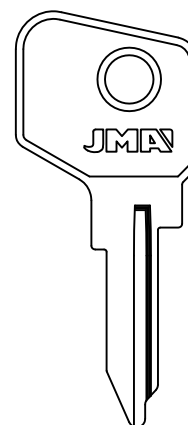

NE-46  
FIAT

NEIMAN (RA)

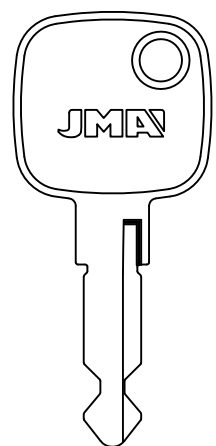

NE-47  
FIAT

NEIMAN

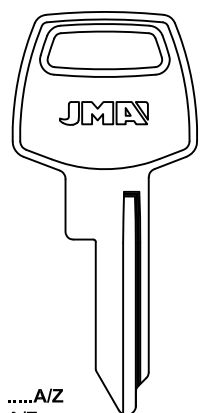

.....A/Z  
A/Z.....  
A/Z.....A/Z  
1 AL 7  
.....A/Z  
0 AL 9  
NE-48

CLAUSOR

NEIMAN (RA)

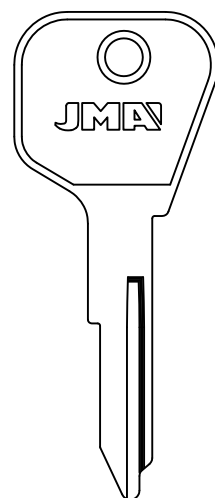

NE-49

NEIMAN

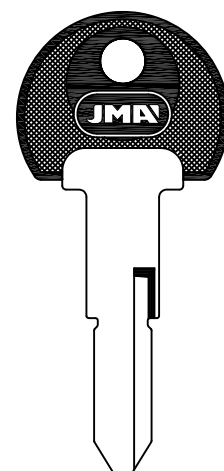

M,N,P,R,S  
1/9...A/Z  
NE-50.P



**NEIMAN**

**NEIMAN (RA)**

**PARA-FOR:**  
NEIMAN (F-RA)

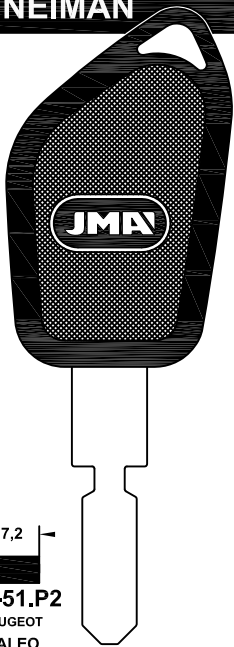

ALP.

3,5 7,2  
**NE-51.P2**  
PEUGEOT  
VALEO

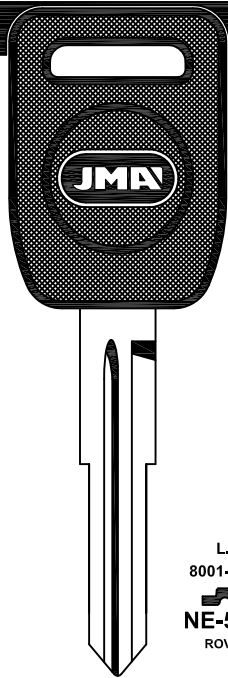

L.....  
8001-10000  
**NE-52.P**  
ROVER

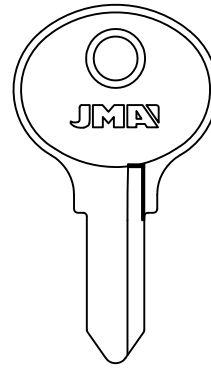

**NE-53**

**NEIMAN (RA)**

**NEIMAN**

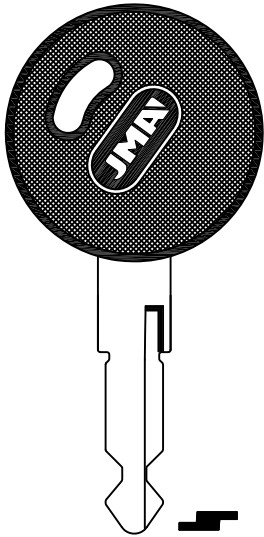

**NE-54.P**  
RENAULT

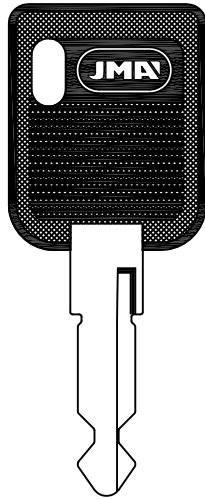

**NE-55.P**  
RENAULT

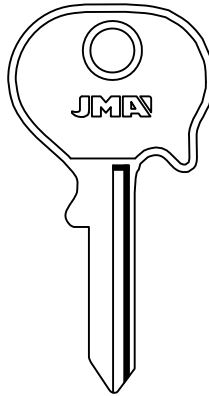

.....  
1 AL 5  
**NE-56**

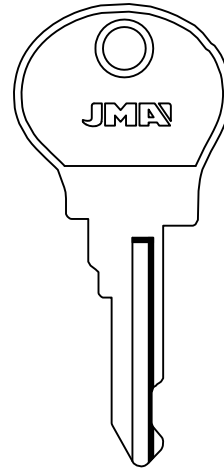

**NE-57**  
MAZDA

**NEIMAN**

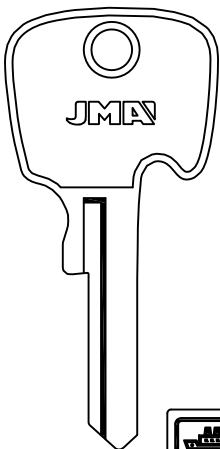

N.....1 AL 5  
**NE-58D**

BOMORO-BOSCH

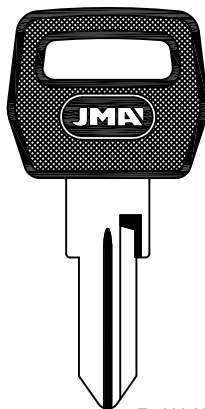

T...001-999  
V...000-922  
2.....  
2.....A/Z  
B-C-D-E-G

**NE-59.P**

CLAUSOR

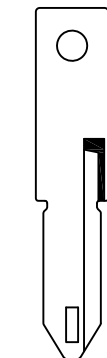

..1/9....  
1/9....A/Z  
.1/9....A/Z  
..1/9....A/Z  
...1/9....A/Z  
....1/9..A/Z  
.....1/9..A/Z A/Z  
.....1/9..A/Z  
M-N-P-R-S  
**NE-60C1**

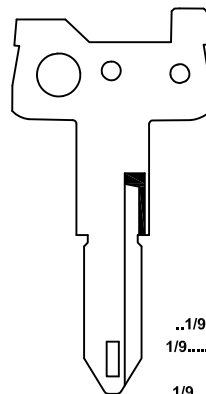

..1/9....  
1/9....A/Z  
..1/9....A/Z  
...1/9....A/Z  
....1/9..A/Z  
.....1/9..A/Z A/Z  
.....1/9..A/Z  
M-N-P-R-S  
**NE-60C2**





**PARA-FOR:**

NEIMAN (F)

NISSAN (J)

**NEIMAN**

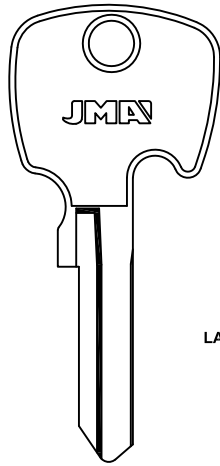

LAT.

D...  
1-2-3-4-5  
  
NE-61D

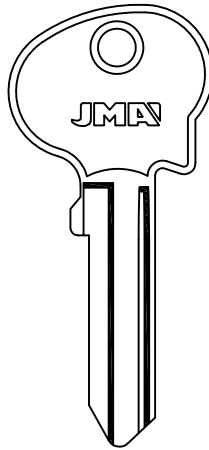

LAT.

8...  
1-2-3-4-5  
  
NE-62

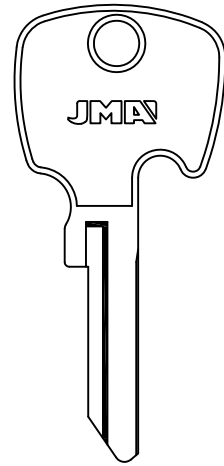

M...  
1-2-3-4-5  
  
NE-63D

**NISSAN**

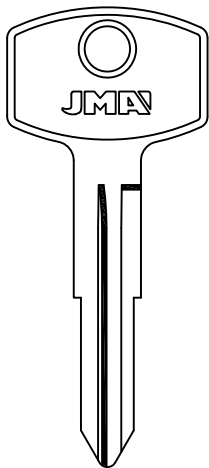

F  
0001-1000  
1001-2000  
M  
4001-5000  
  
DAT-1I

M  
0001-1000  
5001-6000  
N  
1001-2000  
  
DAT-1D

M  
6001-7000  
W  
0001-1000  
  
DAT-2I

M  
7001-8000  
  
DAT-2D

NISSAN-SUBARU  
DATSUN-WASO

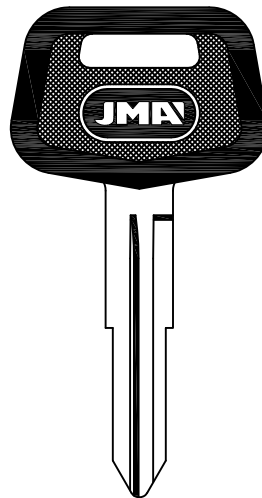

F  
0001-1000  
1001-2000  
M  
4001-5000  
  
DAT-1I.P

M  
0001-1000  
5001-6000  
N  
1001-2000  
  
DAT-1D.P

M  
6001-7000  
W  
0001-1000  
  
DAT-2I.P

M  
7001-8000  
  
DAT-2D.P

NISSAN-SUBARU  
DATSUN-WASO

**NISSAN**

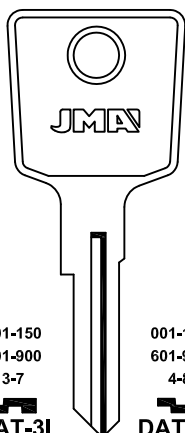

001-150  
601-900  
3-7  
  
DAT-3I

001-150  
601-900  
4-8  
  
DAT-3D

001-150  
601-900  
1-5  
  
DAT-4I

001-150  
601-900  
6-9  
  
DAT-4D

MAZDA-NISSAN-SUBARU  
DATSUN

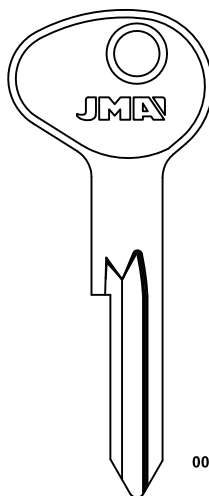

VH  
0001-3948  
K  
00001-14000  
  
DAT-5D

NISSAN  
DATSUN-WASO

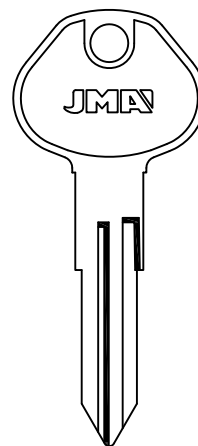

X  
0001-8000  
  
DAT-6

DAT-6D

Y  
0001-8000  
8001-9000  
  
DAT-7

ALFA ROMEO-DELTA-EBRO-GMC-INFINITI-NISSAN-SUBARU  
DATSUN





# NISSAN

PARA-FOR:  
NISSAN (J)



X....1-9000  
  
DAT-6C1

VALEO

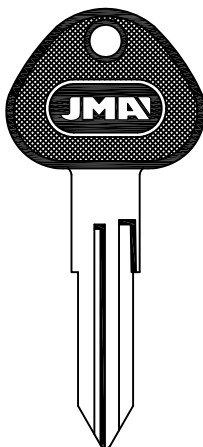

X  
0001-8000  
  
DAT-6.P

DAT-6D.P

Y  
0001-8000  
8001-9000  
  
DAT-7.P

ALFA ROMEO-DELTA-EBRO-GMC-INFINITI-NISSAN-SUBARU  
DATSUN

# NISSAN



X  
0001-8000  
  
DAT-6.P1

DAT-6D.P1

Y  
0001-8000  
8001-9000  
  
DAT-7.P1

INFINITI-NISSAN-SUBARU  
DATSUN

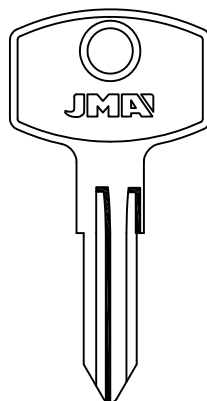

F  
0001-1000  
1001-2000  
M  
4001-5000  
  
DAT-8I

M  
0001-1000  
5001-6000  
N  
1001-2000  
  
DAT-8

M  
6001-7000  
7001-800  
W  
0001-1000  
  
DAT-9I

M  
7001-800  
  
DAT-9D

NISSAN-SUBARU  
DATSUN

# NISSAN

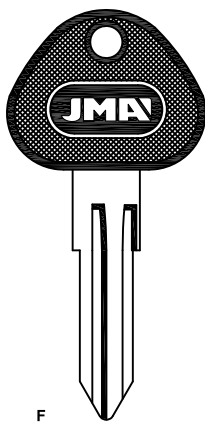

F  
0001-1000  
1001-2000  
M  
4001-5000  
  
DAT-8I.P1

NISSAN-SUBARU  
DATSUN

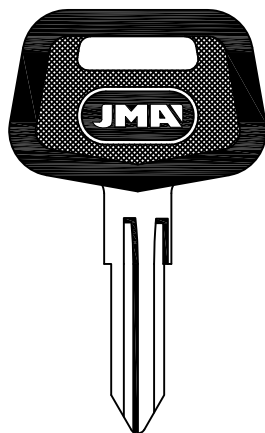

F  
0001-1000  
1001-2000  
M  
4001-5000  
  
DAT-8I.P

M  
6001-7000  
7001-800  
W  
0001-1000  
  
DAT-9I.P

NISSAN-SUBARU  
DATSUN

M  
0001-1000  
5001-6000  
N  
1001-2000  
  
DAT-8.P

M  
7001-800  
  
DAT-9D.P

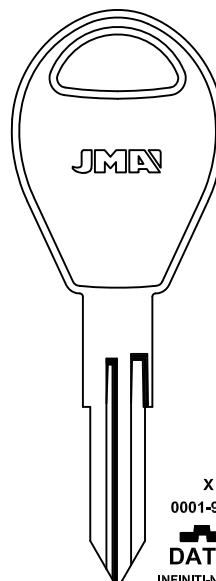

X  
0001-9000  
  
DAT-10

INFINITI-NISSAN



PARA-FOR:

NISSAN (J)

NISSAN

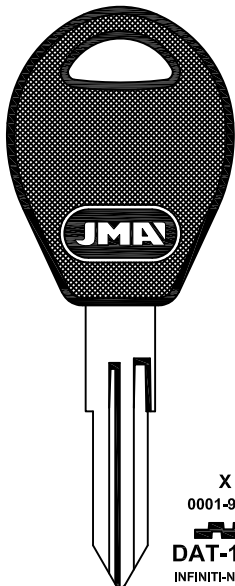

X  
0001-9000

DAT-10.P  
INFINITI-NISSAN

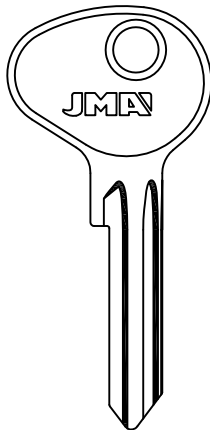

VH  
0001-3948  
K  
00001-14000

DAT-11 DAT-11D  
MAZDA-SUBARU  
DATSUN-WASO

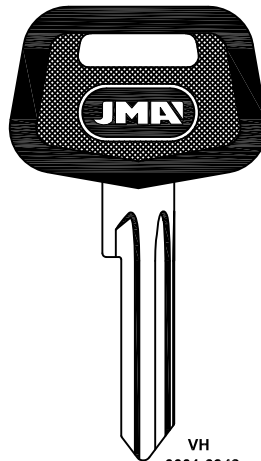

VH  
0001-3948  
K  
00001-14000

DAT-11.P DAT-11D.P  
MAZDA-SUBARU  
DATSUN-WASO

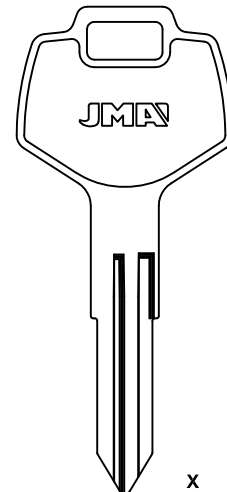

X  
0001-9000

DAT-12  
HOLDEN-NISSAN

NISSAN

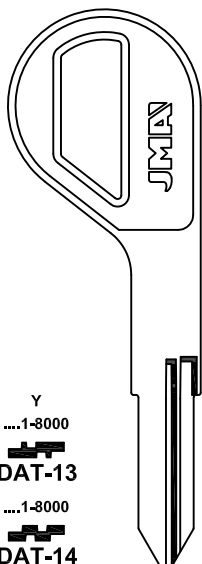

Y  
....1-8000

DAT-13

....1-8000

DAT-14

INFINITI

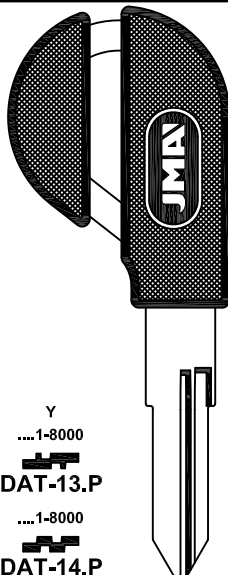

Y  
....1-8000

DAT-13.P

....1-8000

DAT-14.P

INFINITI

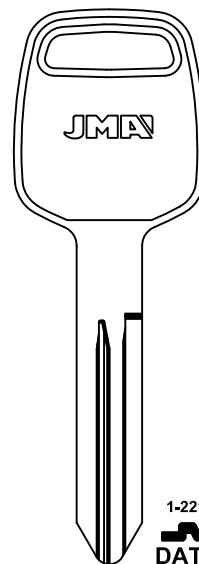

1-22185

DAT-15



....1-22185

DAT-15C1

VALEO

NISSAN



....1-22185

DAT-15C2

VALEO

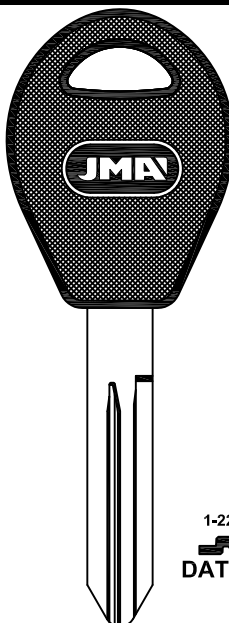

1-22185

DAT-15.P

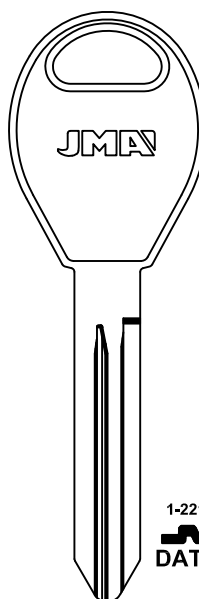

1-22185

DAT-16

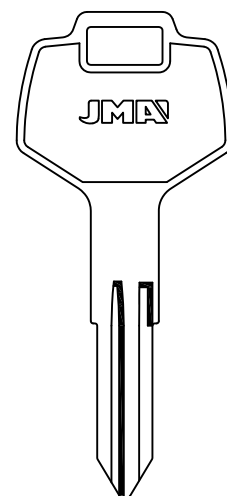

DAT-17

DAT-17D



# NISSAN

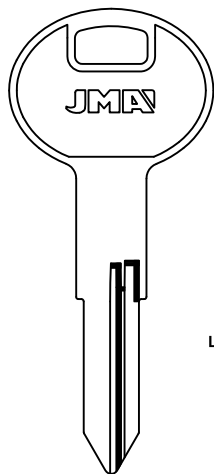

**DAT-18**

LAT.

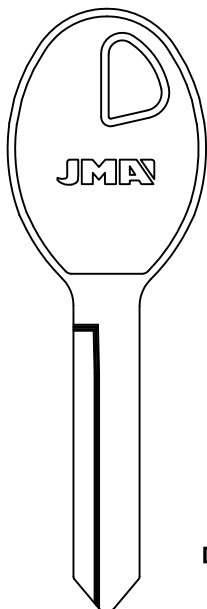

A  
101-291  
501-579  
B  
101-332  
501-602  
C  
101-344  
501-624  
D  
101-327  
501-602  
E  
101-296  
501-579  
**DAT-19**

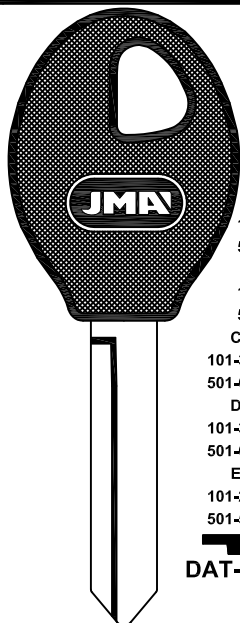

A  
101-291  
501-579  
B  
101-332  
501-602  
C  
101-344  
501-624  
D  
101-327  
501-602  
E  
101-296  
501-579  
**DAT-19.P**

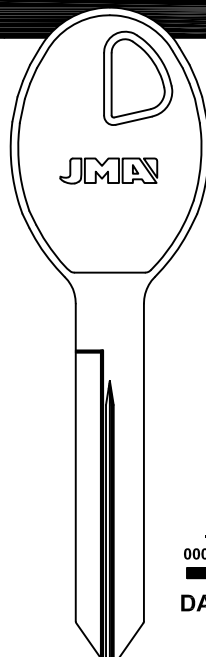

....X  
0001-1706  
**DAT-20**

# PARA-FOR:

NISSAN (J)

PGO (J)

PJ (F)

# NISSAN

# PGO

# PJ

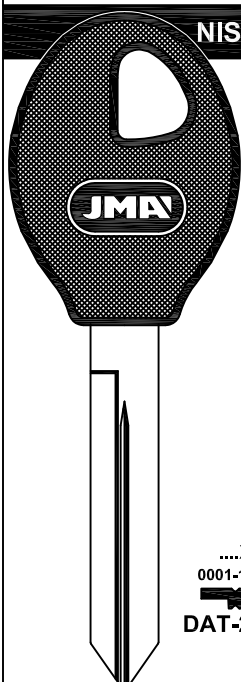

....X  
0001-1706  
**DAT-20.P**

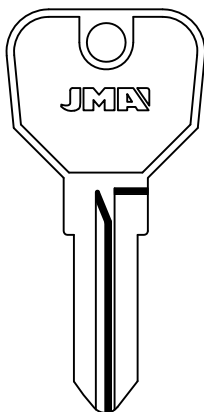

**PGO-1**

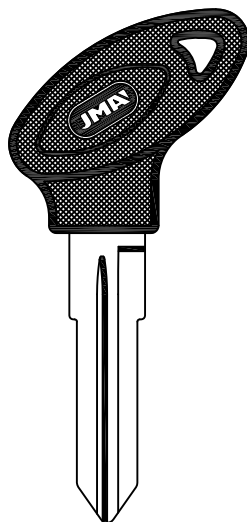

**PGO-2.P**

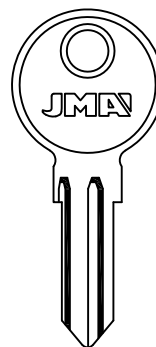

J...  
001-224  
**PJ-1**

DAF-RENAULT-TALBOT S.-VOLKSWAGEN  
KIFERM

# PJ

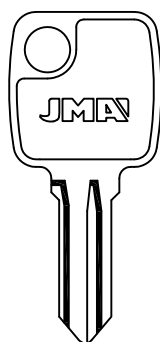

J...  
001-224  
**PJ-2**

KIFERM

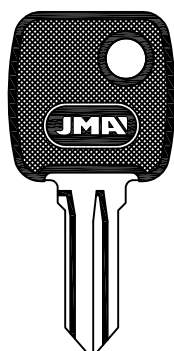

J...  
001-224  
**PJ-2.P**

KIFERM

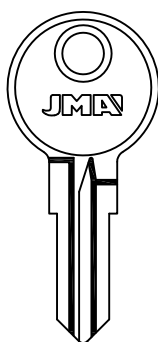

K....4-6-8  
K....4-6-8-A-B-C  
G..01-99

**PJ-3**

TALBOT SIMCA

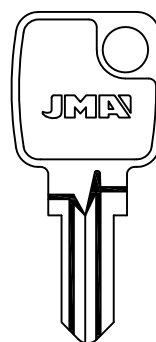











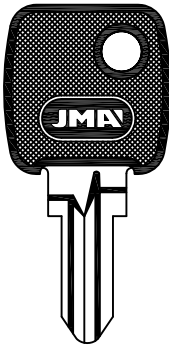

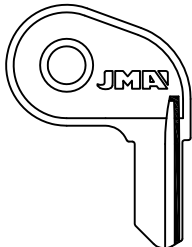

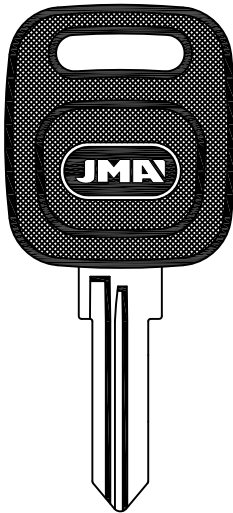

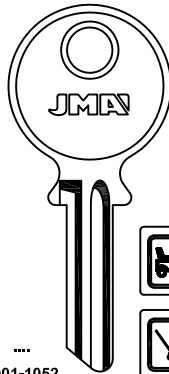



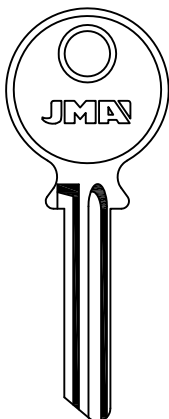

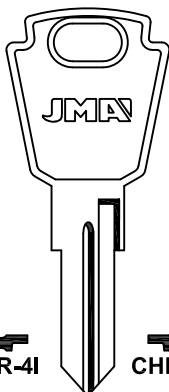





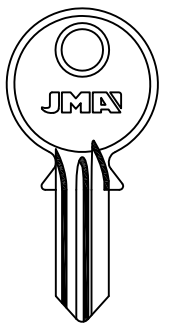

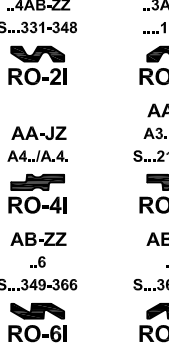

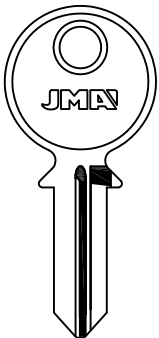

K....4-6-8  
K....4-6-8-A-B-C

**PJ-K**

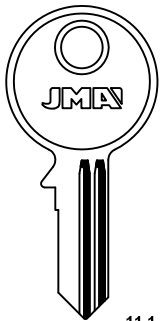

**PARA-FOR:**

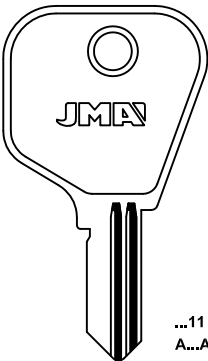
- PJ (F)
- POLLAK (USA)
- POS (D)
- PRESTA (D)
- RONIS (F)

PJ	POLLAK	POS	PRESTA
  K....4-6-8 K....4-6-8-A-B-C  PJ-K.P	  PLL-1 ERINRUDE	  POS-1D.P SISPA	   .... 1001-1052 .... 7200-7399  PRE-1I  PRE-3 FIAT IVECO-MAGIRUS DEUTZ LAPORTE
PRESTA	RONIS		
  ...7700-7749  PRE-2I LAPORTE	  CHR-4I  RO-1IS   CHR-4D  RO-1DS C 001-224  RO-3	 A8..AA-DS ..8AB-ZZ S...385-402  RO-1I  A9..AA-DS ..8AB-ZZ S...403-420  RO-1D CITROEN-PEUGEOT-RENAULT-TALBOT ABSA-FROSER-PJ-SADV	 ..4AB-ZZ S...331-348  RO-2I  AA-JZ A4..A.A.4.  RO-4I  AB-ZZ ..6 S...349-366  RO-6I  ..3AB-ZZ ...1 AL 4  RO-2D  AA-JZ A3..A.A.3. S...213-246  RO-4D  AB-ZZ ..7 S...367-384  RO-6D
RONIS			
  C4..AA-ZY D4..AA-HR  RO-5I CITROEN-PEUGEOT ABSA	 ...151-700 E...1-1000 T...107-400 Y...101-600  ...11 1-700 A...A1-700 C...101-600 D...1-1000 T...1-380 TA...1-224 GV...1-300 ...F1-500 1F..1-21  ...151-700 E...1-1000 T...107-400 Y...101-600  RO-7I ALFA ROMEO-RENAULT	ARMOR EMHART FORINDEX KARDEX MLM NEMEF RONEO SANEL STRAFOR SCHAFER YAC  ...151-700 E...1-1000 T...107-400 Y...101-600  RO-8I  F...1-500  RO-30  ...11 1-700 A...A1-700 C...101-600 D...1-1000 T...1-380 TA...1-224 GV...1-300 ...F1-500 1F..1-21  ...151-700 E...1-1000 T...107-400 Y...101-600  RO-11I PEUGEOT-RENAULT ABSA-SADV-SIMPLEX	 T...1-380 TA...1-224 GV...1-300 ...F1-500 1F..1-21  RO-8D  ...11 1-700 A...A1-700 C...101-600 D...1-1000 T...1-380 TA...1-224 GV...1-300 ...F1-500 1F..1-21  RO-11D



## RONIS

## PARA-FOR:

RONIS (F)

ROSS (E)

SAAB (S)

SAFE (I)

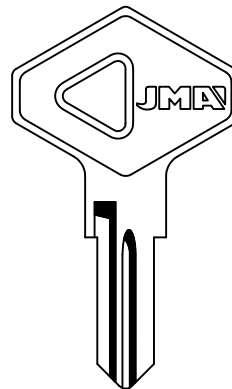
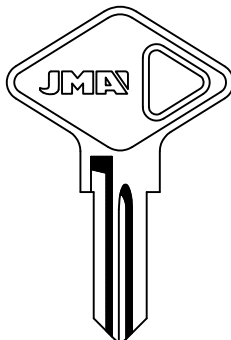
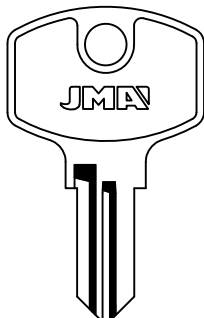
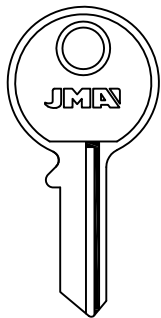

RO-12I

RO-12D

M...601-983

TAV

RO-16I

RO-16D

BURG-STRAFOR

RO-14  
PEUGEOT

70.....  
1 AL 3  
...1-975  
RO-15  
ACN-ARO DACIA-RENAULT

77....  
0 AL 3  
RO-17  
RENAULT

## ROSS

## SAAB

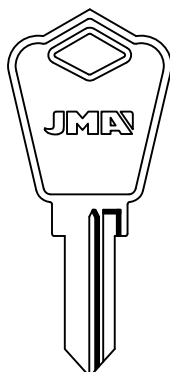
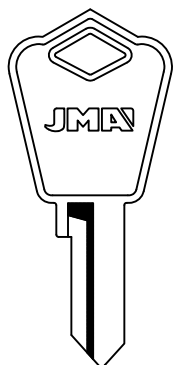

ROS-1D

ROS-2

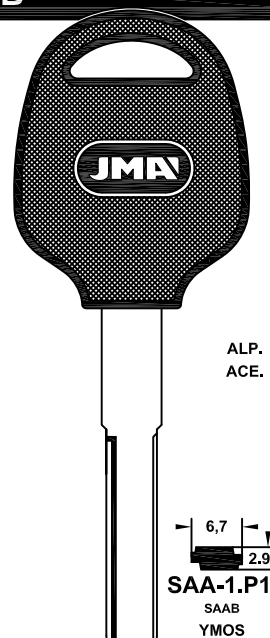
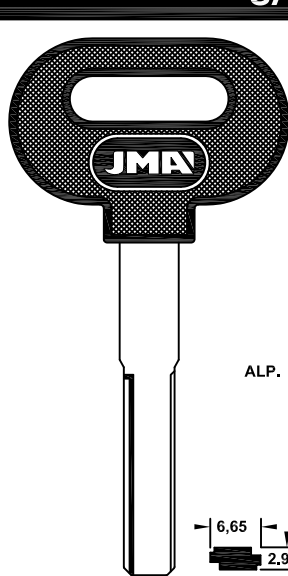

ALP.

ALP.  
ACE.

6,65  
2,9

SAA-1.P

SAAB  
YMOS

6,7  
2,95

SAA-1.P1

SAAB  
YMOS

## SAAB

## SAFE

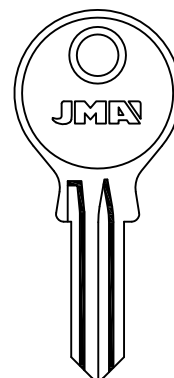
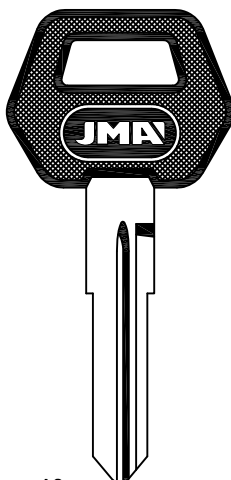
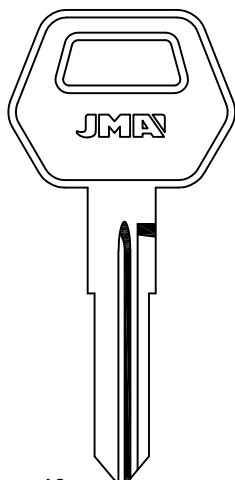
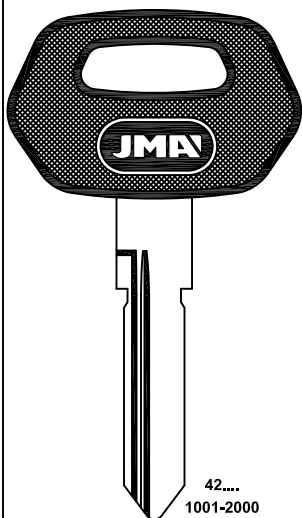

42....  
1001-2000  
SAA-2.P

AC  
1-3192  
SAA-AC

AC  
1-3192  
SAA-AC.P  
SAAB  
YMOS

15-I      15-D

TRAMA-FIST

**JMA**<sup>®</sup>

Copyright by Alejandro Altuna S.A. 2014



ATENCIÓN: Concerniente a las marcas y denominaciones comerciales ver nota en índice.  
ATTENTION: Concerning the marks and commercial denominations see note in index.  
ATTENTION: Concernant les marques et dénominations commerciales voir la note dans l'index.  
ACHTUNG: Beziehen auf die marke und handelsname sehen sie die notiz im index.

**PARA-FOR:**

SAFE (I)

SIMPLEX (F)

**SAFE**

		<b>A</b>	<b>B</b>	<b>D</b>	<b>C</b>		
		001-125	001-125	1-125	1-125		
		<b>AF-1I</b>	<b>AF-1D</b>	<b>AF-2I</b>	<b>AF-2D</b>		
		ALFA ROMEO-AUTOBIANCHI		ALFA ROMEO-AUTOBIANCHI			
		SIPEA-MAGNETI MARELLI		SIPEA-MAGNETI MARELLI			

**SAFE**

<p><b>S</b></p> <p>615-699 712-799 812-899</p> <p></p> <p><b>AF-4I</b></p> <p>ALFA ROMEO-FIAT FIST-TRAMA</p>	<p><b>D</b></p> <p>115-199 212-299 312-399</p> <p></p> <p><b>AF-4D</b></p>	<p><b>CROMODORA</b> FIST FREA GIOBERT MIRAGLIO RUFFINI</p> <p><b>6</b></p> <p>100-309</p> <p></p> <p><b>AF-5I</b></p> <p><b>2</b></p> <p>100-309</p> <p></p> <p><b>AF-6I</b></p> <p>ALFA ROMEO-AUTOBIANCHI-FIAT</p>	<p><b>8</b></p> <p>100-309</p> <p></p> <p><b>AF-5D</b></p> <p><b>4</b></p> <p>100-309</p> <p></p> <p><b>AF-6D</b></p> <p>ALFA ROMEO-AUTOBIANCHI-FIAT</p>
--	--	---	--

<p><b>1</b></p> <p>100-789</p> <p></p> <p><b>AF-11</b></p> <p><b>3</b></p> <p>100-789</p> <p></p> <p><b>AF-12</b></p> <p>ALFA-INNOCENTI-LANCIA-MASERATI</p>	<p><b>1</b></p> <p>100-789</p> <p></p> <p><b>AF-10</b></p> <p><b>5</b></p> <p>100-789</p> <p></p> <p><b>AF-12</b></p>	<p><b>3</b></p> <p>0501-1000</p> <p></p> <p><b>IMS-3</b></p> <p><b>1</b></p> <p>0501-1000</p> <p></p> <p><b>IMS-5</b></p> <p><b>IMS-13</b></p> <p>BLOSTER CROMODORA-FIST-JMSA</p>	<p><b>4</b></p> <p>0501-1000</p> <p></p> <p><b>AF-21</b></p> <p><b>2</b></p> <p>0501-1000</p> <p></p> <p><b>AF-19</b></p>
---	---	---	---

**SAFE**

<p><b>3</b></p> <p>0501-1000</p> <p></p> <p><b>IMS-3.P</b></p> <p><b>1</b></p> <p>0501-1000</p> <p></p> <p><b>IMS-5.P</b></p> <p><b>IMS-13.P</b></p> <p>BLOSTER CROMODORA-FIST-JMSA</p>	<p><b>4</b></p> <p>0501-1000</p> <p></p> <p><b>AF-21.P</b></p> <p><b>2</b></p> <p>0501-1000</p> <p></p> <p><b>AF-19.P</b></p>
---	---

**SIMPLEX**

<p>UV/Y...U</p> <p>1 AL 7</p> <p></p> <p><b>CT-1</b></p> <p>CITROEN-FIAT IVECO NEIMAN-VACHETTE</p>	<p>UV/Y...U</p> <p>1 AL 7</p> <p></p> <p><b>CT-1.P</b></p> <p>CITROEN-FIAT IVECO NEIMAN-VACHETTE</p>	<p>S....</p> <p>....S</p> <p>1 AL 8</p> <p></p> <p><b>CT-2</b></p> <p>CITROEN NEIMAN-VACHETTE</p>
--	--	---





## SIMPLEX

PARA-FOR:  
SIMPLEX (F)

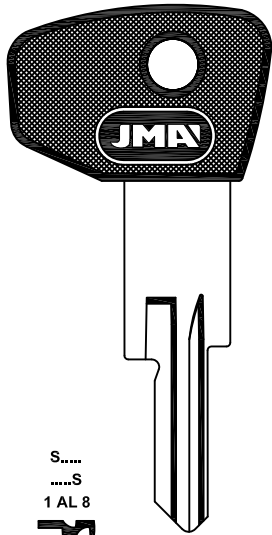

S.....  
.....S  
1 AL 8

CT-2.P

CITROEN  
NEIMAN-VACHETTE

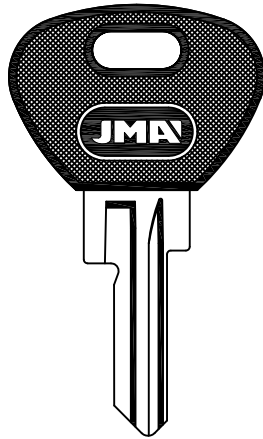

S.....  
.....S  
1 AL 8

CT-2.P1

CITROEN  
NEIMAN-VACHETTE

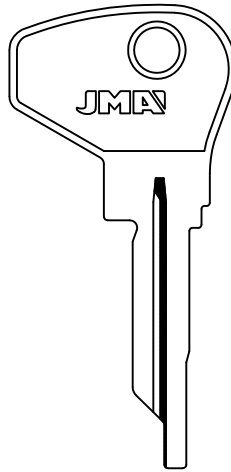

B-T.....T  
1 AL 7

CT-3

CITROEN-MASERATI-FIAT IVECO  
NEIMAN-VACHETTE

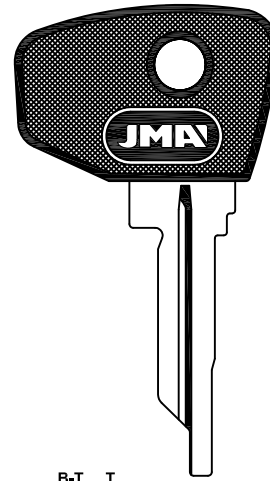

B-T.....T  
1 AL 7

CT-3.P

CITROEN-MASERATI-FIAT IVECO  
NEIMAN-VACHETTE

## SIMPLEX

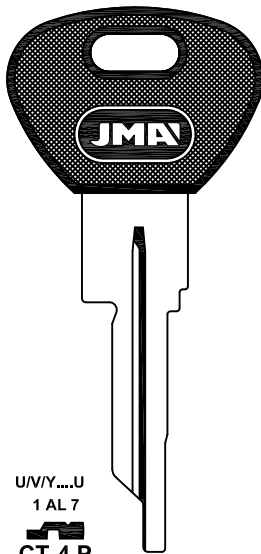

U/V/Y.....U  
1 AL 7

CT-4.P

CITROEN-FIAT IVECO  
NEIMAN-VACHETTE

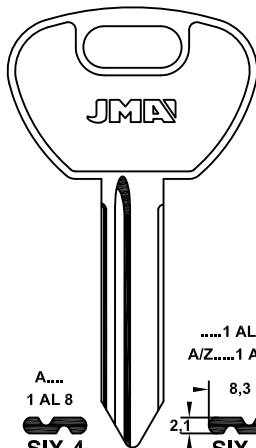

A.....  
1 AL 8  
SIX-4

.....1 AL 8  
A/Z.....1 AL 8  
8,3  
2,1  
SIX-1

CITROEN-PEUGEOT  
NEIMAN

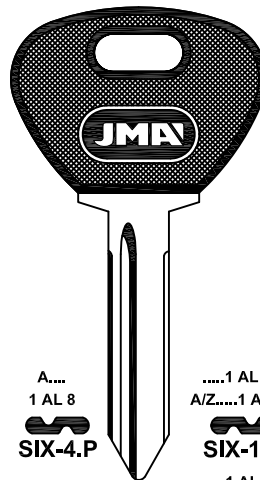

A.....  
1 AL 8  
SIX-4.P

.....1 AL 8  
A/Z.....1 AL 8  
SIX-1.P

CITROEN-PEUGEOT  
NEIMAN

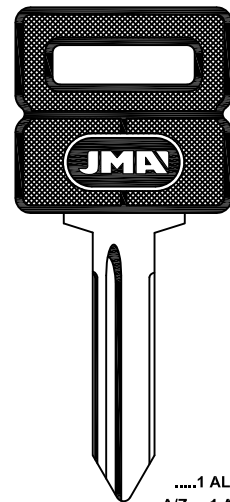

.....1 AL 8  
A/Z.....1 AL 8  
SIX-1.P1

CITROEN-PEUGEOT  
NEIMAN

## SIMPLEX

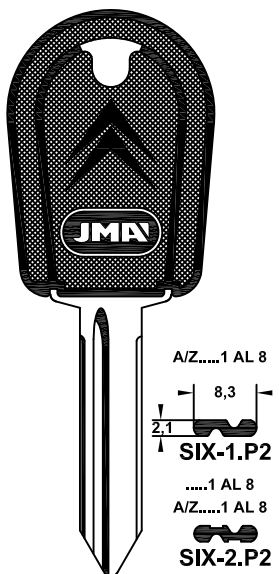

A/Z.....1 AL 8  
8,3  
2,1  
SIX-1.P2

.....1 AL 8  
A/Z.....1 AL 8  
SIX-2.P2

NEIMAN

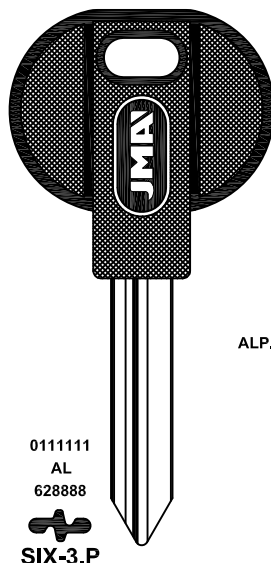

0111111  
AL  
628888

SIX-3.P

CITROEN

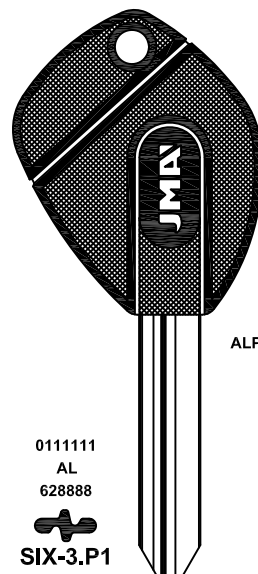

0111111  
AL  
628888

SIX-3.P1

CITROEN-FIAT-LANCIA-PEUGEOT

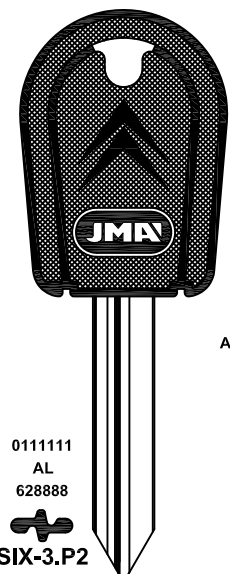

0111111  
AL  
628888

SIX-3.P2

CITROEN

**JMA**<sup>®</sup>

Copyright by Alejandro Altuna S.A. 2014



ATENCIÓN: Concerniente a las marcas y denominaciones comerciales ver nota en índice.  
ATTENTION: Concerning the marks and commercial denominations see note in index.  
ATTENTION: Concernant les marques et dénominations commerciales voir la note dans l'index.  
ACHTUNG: Beziehen auf die marke und handelsname sehen sie die notiz im index.



**PARA-FOR:**











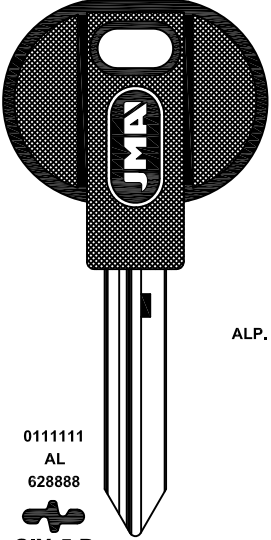

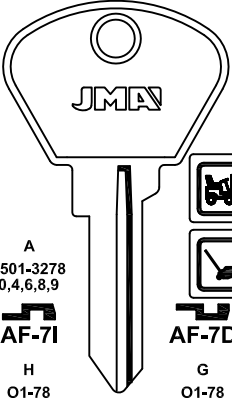
SIMPLEX (F)



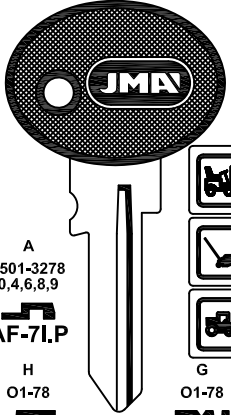



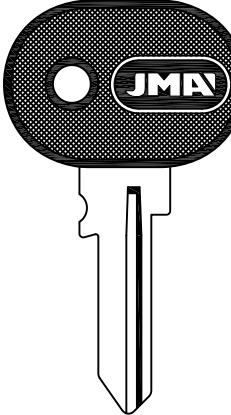

SIPEA (I)

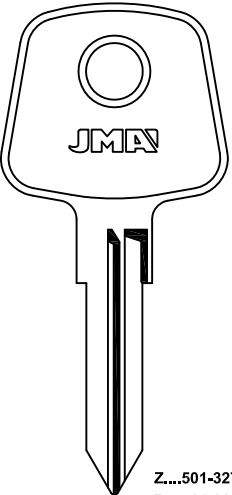

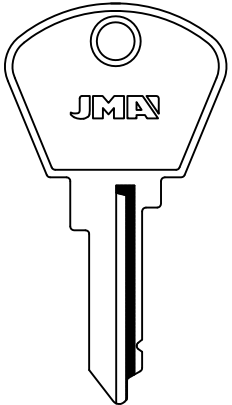

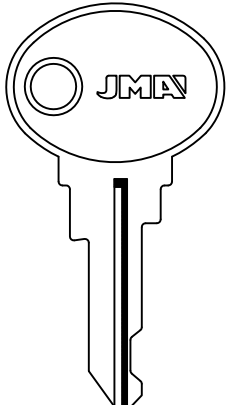

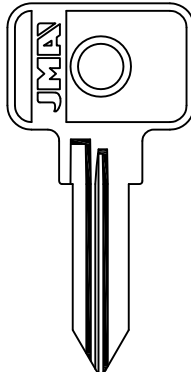

SISPA (I)

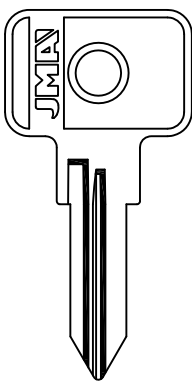
SSANGYONG

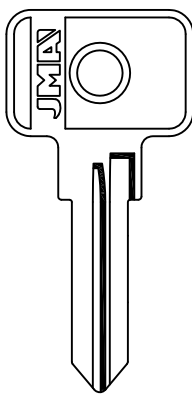
(K)

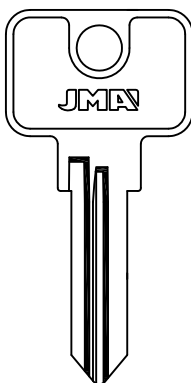
SIMPLEX	SIPEA		
 0111111 AL 628888  <b>SIX-5.P</b> CITROEN	 A 0501-3278 0,4,6,8,9  <b>AF-7I</b> H 01-78  <b>AF-8I</b> F 01-78  <b>AF-9I</b> ALFA-AUTOBIANCHI-FIAT-LANCIA SAFE	 A 0501-3278 0,4,6,8,9  <b>AF-7I.P</b> H 01-78  <b>AF-8I.P</b> F 01-78  <b>AF-9I.P</b> ALFA-AUTOBIANCHI-FIAT-LANCIA SAFE	 A 0501-3278 0,4,6,8,9  <b>AF-7I.P1</b> FERRARI-FIAT-LAMBORGHINI-MASERATI NEIMAN

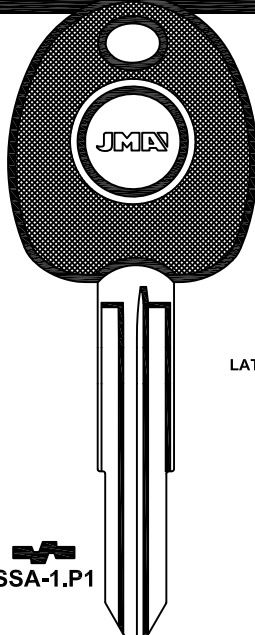
SIPEA			SISPA
 Z....501-3278 P....501-3278  <b>SIP-1</b> OM IVECO-YUGO ZASTAVA-FIAT IVECO	 ....4-6-8-9  <b>SIP-2</b> FIAT-PREMIER MAGNETI MARELLI-NEIMAN	 B....501-3278 B....0-4-6-8-9  <b>SIP-3</b> A.ROMEO-AUTOBIANCHI-FIAT-LANCIA ARTEB-CLAUSOR-NEIMAN	  ....1100-1307  <b>SI-1D</b> AUTOBLOCK

SISPA			SSANGYONG
  <b>SI-3</b> AUTOBLOCK	  <b>SI-4</b> AUTOBLOCK	  <b>SI-5D</b> AUTOBLOCK	 LAT.  <b>SSA-1.P1</b>



**STREBOR**

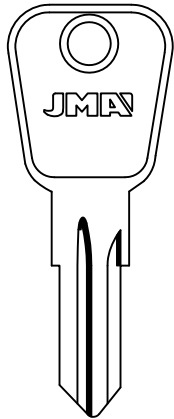

SF...101-199  
SR...301-399  
SS...201-299  
SO...01-99



**STR-3**

UNION

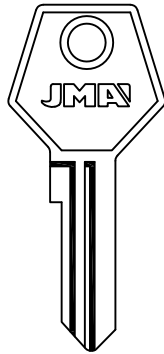

S..1-70



**STR-4**

**STS**

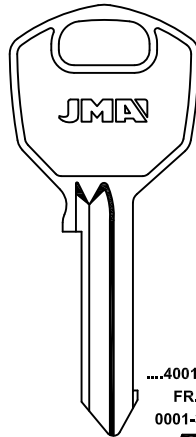

...4001-6000

FR...

0001-3040



**STS-2D**



**STS-5D**

EBRO-NISSAN  
BLOCK-DOM

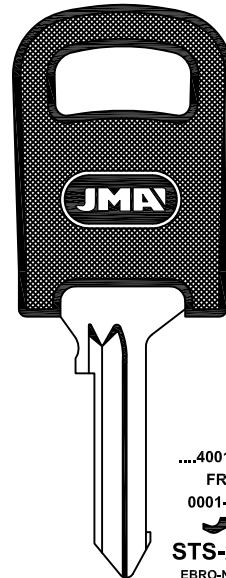

...4001-6000

FR...

0001-3040



**STS-2D.P**

EBRO-NISSAN

BLOCK-DOM

**PARA-FOR:**

STREBOR (GB)

STS (E)

SUBARU (J)

SUZUKI (J)

**STS**

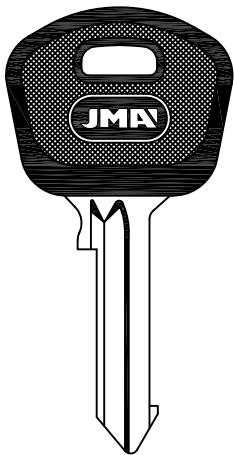

**STS-5D.P**

EBRO-NISSAN  
DOM

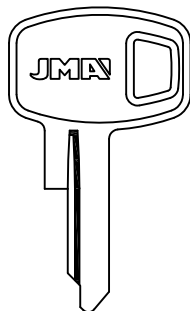

**STS-11**

PIAGGIO

**SUBARU**

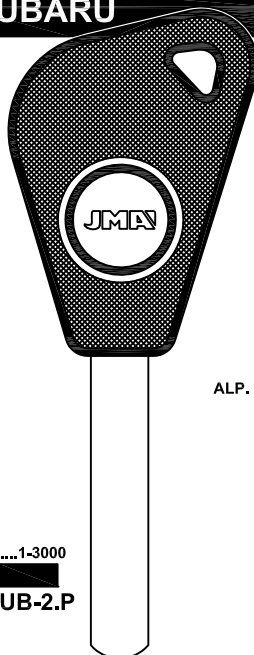

ALP.

T...1-3000



**SUB-2.P**

**SUZUKI**

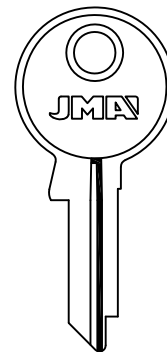

**SUZU-1I**



**SUZU-2I**



**SUZU-1D**



**SUZU-2D**

**SUZUKI**

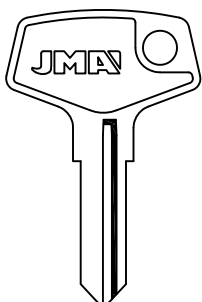

**SUZU-3I**

SUZUKI

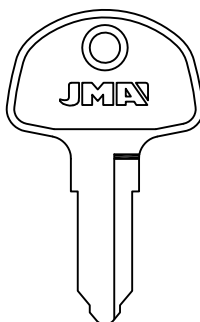

**SUZU-4I**



**SUZU-4D**

BIMOTA-CAGIVA-HONDA-KAWASAKI  
LAVERDA-AUGUSTA-PEUGEOT-SUZUKI

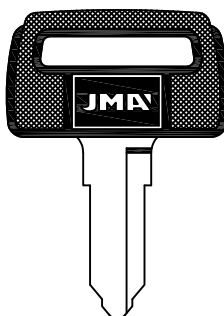

**SUZU-4D.P**

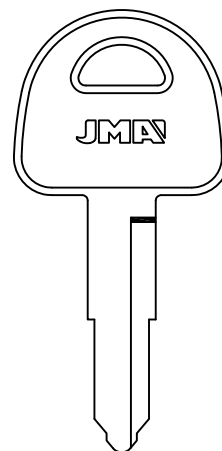

**SUZU-5**

BIMOTA-SUZUKI



PARA-FOR:

SUZUKI (J)

SUZUKI

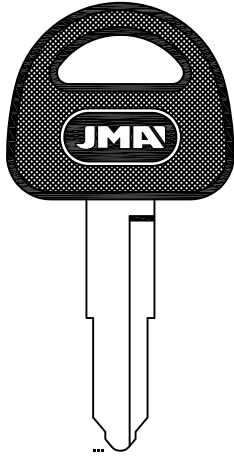

...  
101-499  
751-795  
  
**SUZU-5.P**  
BIMOTA-SUZUKI

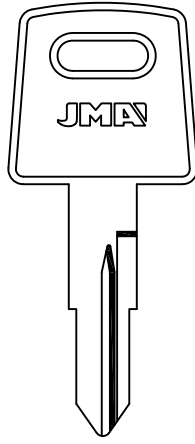

A  
001-133  
  
**SUZU-6**

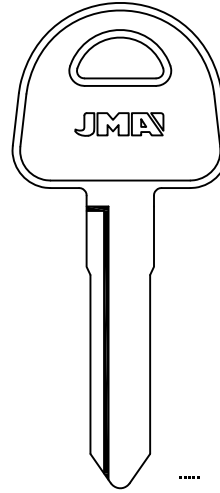

.....  
16501-17704  
  
**SUZU-7**  
GM-MARUTI-SUZUKI



.....  
16501-17704  
  
**SUZU-7.P** **SUZU-7D.P**  
GM-MARUTI-SUZUKI

SUZUKI

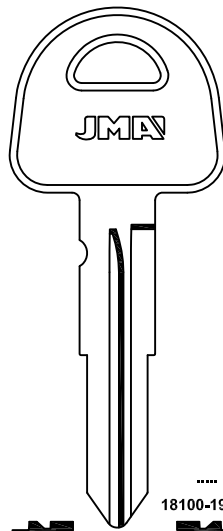

.....  
18100-19229  
  
**SUZU-8**  
SUZUKI

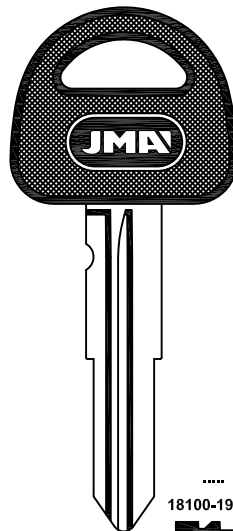

.....  
18100-19229  
  
**SUZU-8.P**  
SUZUKI

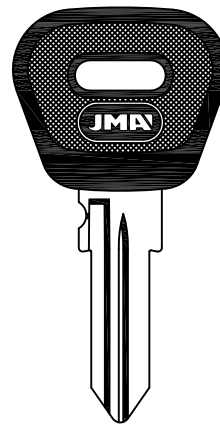

.....1 AL 5  
  
**SUZU-9.P**  
SUZUKI  
CLAUSOR

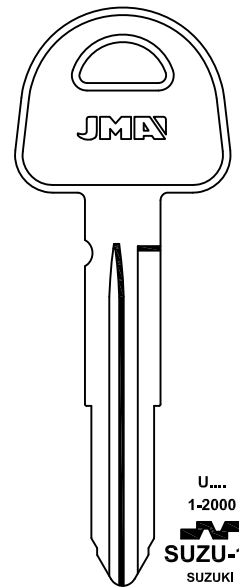

U....  
1-2000  
  
**SUZU-10**  
SUZUKI

SUZUKI

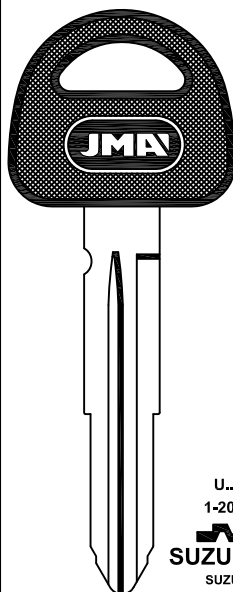

U....  
1-2000  
  
**SUZU-10.P**  
SUZUKI

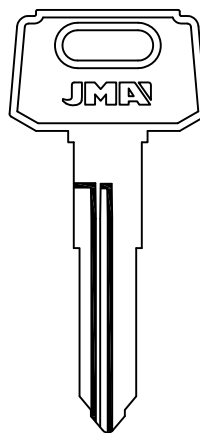

....  
6001-7000  
  
**SUZU-11D**  
SUZUKI

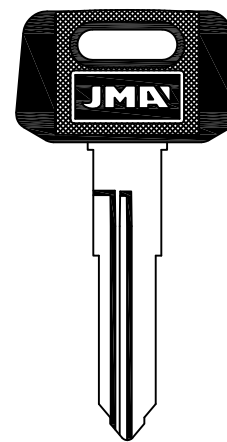

....  
6001-7000  
  
**SUZU-11D.P**  
SUZUKI

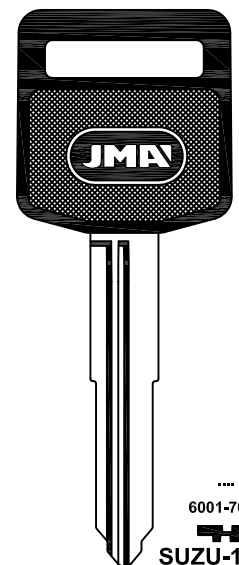

....  
6001-7000  
  
**SUZU-12D.P**  
SUZUKI



**SUZUKI**

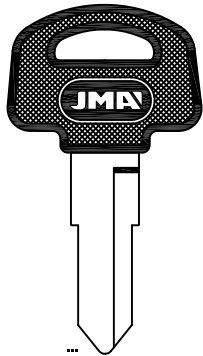

...  
101-499  
751-795  
A00-A99  
**SUZU-13.P**

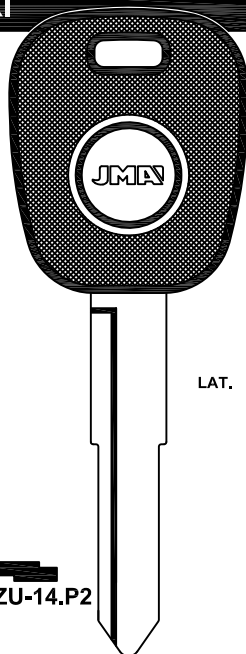

**SUZU-14.P2**

LAT.

**SUZU-13D.P**  
BIMOTA-CAGIVA-HONDA-KAWASAKI  
LAVERDA-AUGUSTA-PEUGEOT-SUZUKI

**TAP-AGIS**



**TAP-1P**

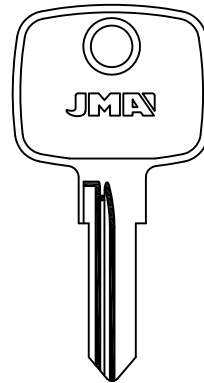

**TAP-2**

**PARA-FOR:**

- SUZUKI (J)
- TAP-AGIS (YU)
- TATA (IND)
- TECUMSEH (A)
- TIBBE (D)
- TITAN (SLO)
- TOOL BOX (USA)

**TATA**

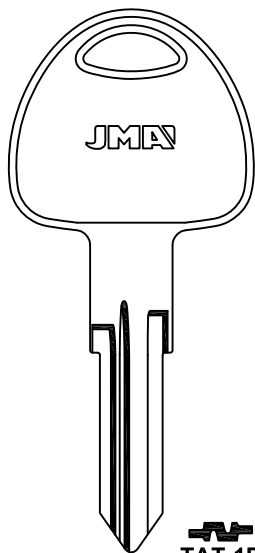

**TAT-1D**



**TAT-1D.P**

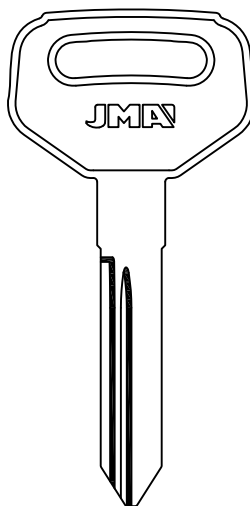

**TAT-2D**

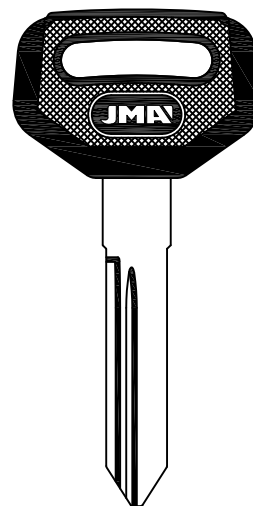

**TAT-2D.P**

**TECUMSEH**

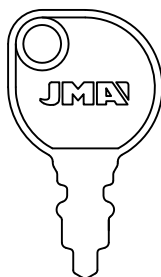

6,2 1,82  
**TEU-1**

INDAK

**TIBBE**

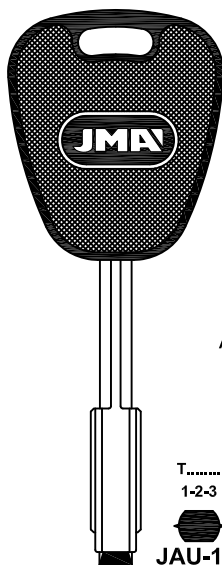

ALP.

T.....  
1-2-3  
**JAU-1.P**

**TITAN**

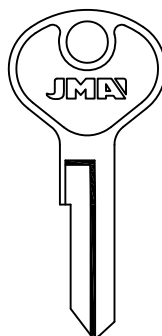

**TIT-7D**

**TOOL BOX**

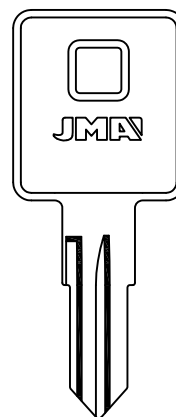









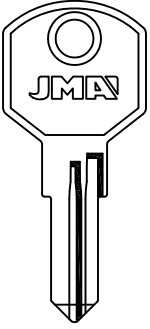

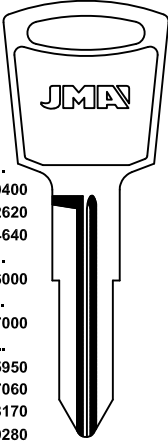

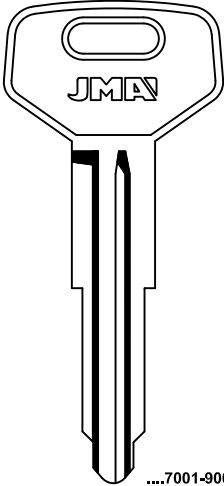

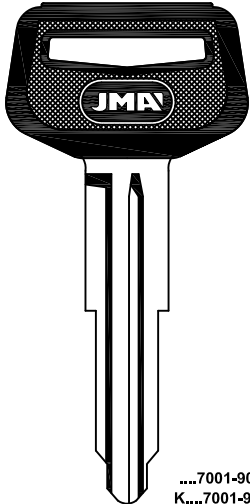

LAT.

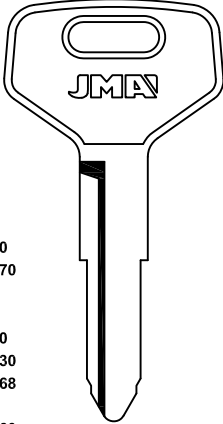



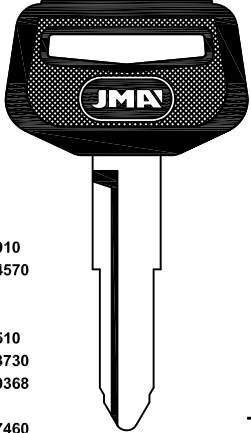



**TOO-1D**

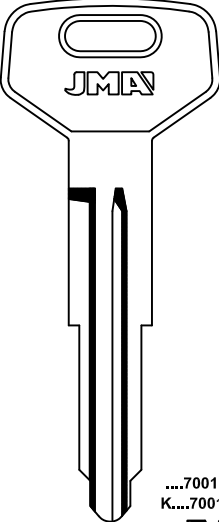

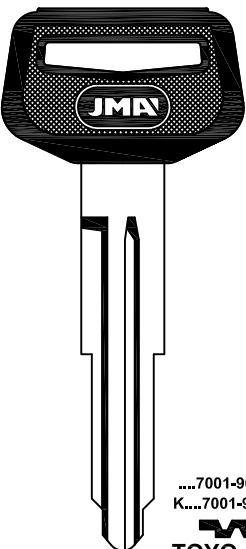
PARA-FOR:  
TOOL BOX (USA)  
TOYOTA (J)

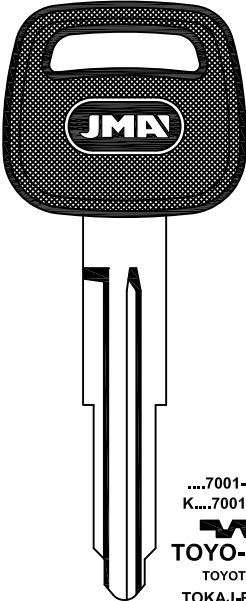
TOOL BOX	TOYOTA		
   <b>TOO-2</b>	<p>LAT.</p> <p>A.... 0001-0400 2221-2620 4441-4640 B.... 5001-6000 C.... 6001-7000 M.... 5551-5950 6661-7060 7771-8170 8814-9280 N.... 1921-2220</p>    <b>TOYO-2</b> GM-TOYOTA TOKAJ-RIKA	   <b>TOYO-3</b> DAIHATSU-TOYOTA TOKAJ-RIKA	   <b>TOYO-3.P</b> DAIHATSU-TOYOTA TOKAJ-RIKA

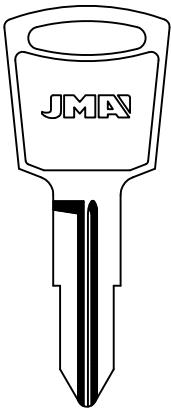
TOYOTA			
<p>K.... 001-400/1511-1910 2221-2620/3731-4570 5001-6368 R.... 401-800/1112-1510 2621-3020/3331-3730 5001-6924/8001-9368 S.... 5951-6350/7061-7460 8171-8570/9281-9680 D.... 6001-7042</p>    <b>TOYO-K1</b> BEDFORD-DAIHATSU-D.MOTOR-HOLDEN-HYUNDAI-SUZUKI-LOTUS-SUZUKI-HINO TOKAJ-RIKA	<p>F.... 5951-6350 7061-7460 8171-8570 9281-9680 P.... 7001-8500</p>  <b>TOYO-4</b> C.... 6001-7042  <b>TOYO-14</b> TOKAJ-RIKA	<p>K.... 001-400/1511-1910 2221-2620/3731-4570 5001-6368 R.... 401-800/1112-1510 2621-3020/3331-3730 5001-6924/8001-9368 S.... 5951-6350/7061-7460 8171-8570/9281-9680 D.... 6001-7042</p>    <b>TOYO-K1.P</b> BEDFORD-DAIHATSU-D.MOTOR-HOLDEN-HYUNDAI-SUZUKI-LOTUS-SUZUKI-HINO TOKAJ-RIKA	<p>F.... 5951-6350 7061-7460 8171-8570 9281-9680 P.... 7001-8500</p>  <b>TOYO-4.P</b> C.... 6001-7042  <b>TOYO-14.P</b> TOKAJ-RIKA

TOYOTA			
<p>....7001-9000 K....7001-9000</p>    <b>TOYO-5</b> TOYOTA TOKAJ-RIKA	<p>....7001-9000 K....7001-9000</p>    <b>TOYO-5.P</b> TOYOTA TOKAJ-RIKA	<p>....7001-9000 K....7001-9000</p>    <b>TOYO-5.P1</b> TOYOTA TOKAJ-RIKA	   <b>TOYO-6</b> TOKAJ-RIKA



**TOYOTA**

**PARA-FOR:**

TOYOTA (J)

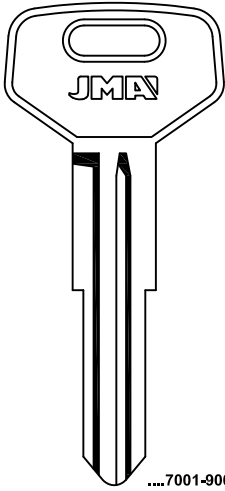

....7001-9000  
K....7001-9000



**TOYO-8**

DAIHATSU-TOYOTA  
TOKAJ-RIKA

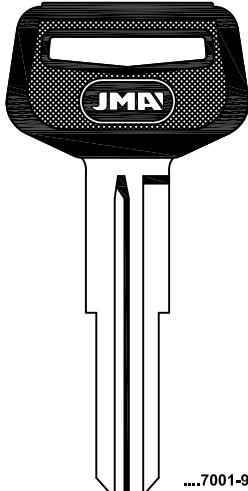

....7001-9000  
K....7001-9000



**TOYO-8LP**

DAIHATSU-TOYOTA  
TOKAJ-RIKA

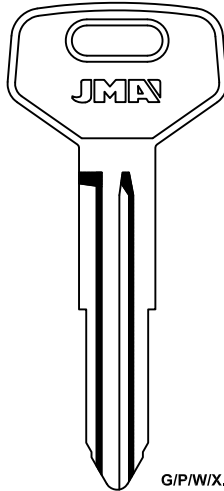

G/P/W/X....  
1-2000



**TOYO-9**

TOYOTA-VOLKSWAGEN  
TOKAJ-RIKA

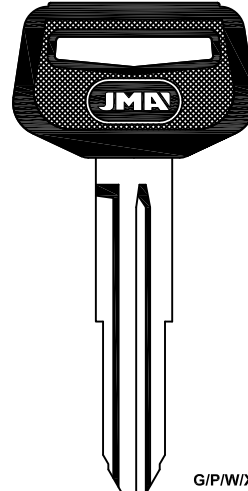

G/P/W/X....  
1-2000



**TOYO-9.P**

TOYOTA-VOLKSWAGEN  
TOKAJ-RIKA

**TOYOTA**

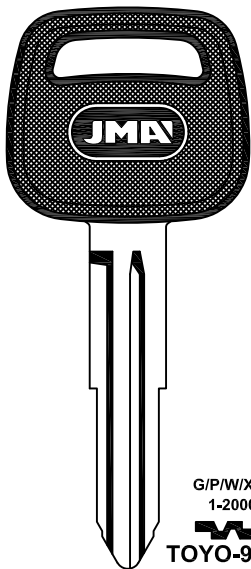

G/P/W/X....  
1-2000



**TOYO-9.P1**

TOYOTA-VOLKSWAGEN  
TOKAJ-RIKA

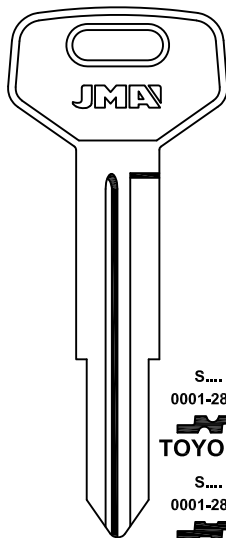

S....  
0001-2878



**TOYO-10**

S....  
0001-2878



**TOYO-11**

TOYOTA  
TOKAJ-RIKA

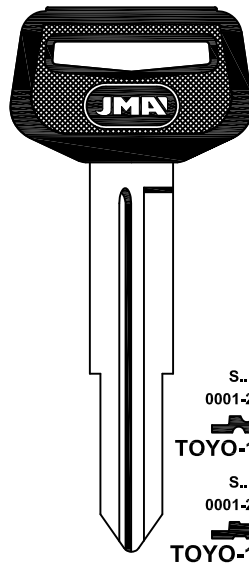

S....  
0001-2878



**TOYO-10.P**

S....  
0001-2878



**TOYO-11.P**

TOYOTA  
TOKAJ-RIKA

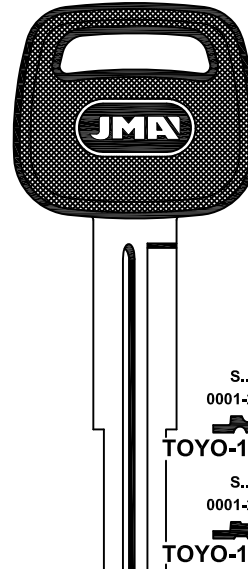

S....  
0001-2878



**TOYO-10.P1**

S....  
0001-2878



**TOYO-11.P1**

TOYOTA  
TOKAJ-RIKA

**TOYOTA**

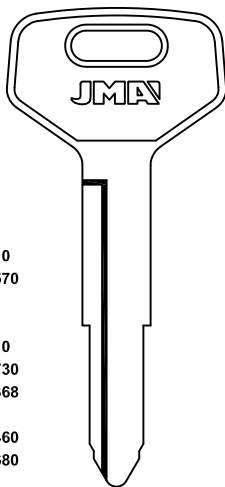

K....  
001-400/1511-1910  
2221-2620/3731-4570  
5001-6368

R....  
401-800/1112-1510  
2621-3020/3331-3730  
5001-6924/8001-9368

S....  
5951-6350/7061-7460  
8171-8570/9281-9680

D....  
6001-7042



**TOYO-12**

TOYOTA  
TOKAJ-RIKA

F....  
5951-6350  
7061-7460  
8171-8570  
9281-9680



**TOYO-13**

C....  
6001-8042  
U....  
3001-4000

Z....  
1-1000



**TOYO-12D**

K....  
001-400/1511-1910  
2221-2620/3731-4570  
5001-6368

R....  
401-800/1112-1510  
2621-3020/3331-3730  
5001-6924/8001-9368

S....  
5951-6350/7061-7460  
8171-8570/9281-9680

D....  
6001-7042



**TOYO-12.P1**

TOYOTA  
TOKAJ-RIKA

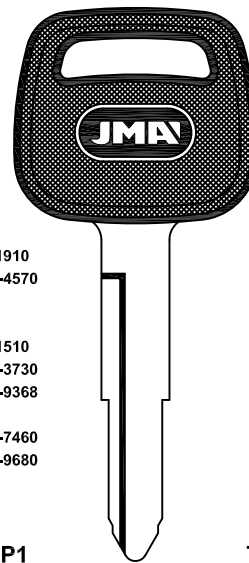

F....  
5951-6350  
7061-7460  
8171-8570  
9281-9680



**TOYO-13.P1**

C....  
6001-8042  
U....  
3001-4000

Z....  
1-1000



**TOYO-12D.P1**





PARA-FOR:

TOYOTA (J)

TOYOTA

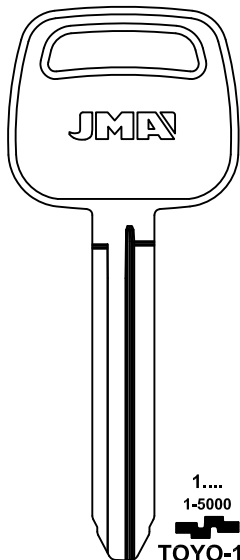

GM-TOYOTA  
TOKAJ-RIKA

1....  
1-5000

TOYO-15

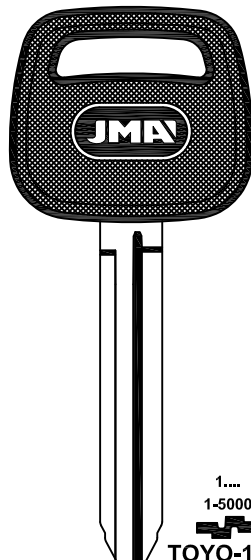

GM-TOYOTA  
TOKAJ-RIKA

1....  
1-5000

TOYO-15.P

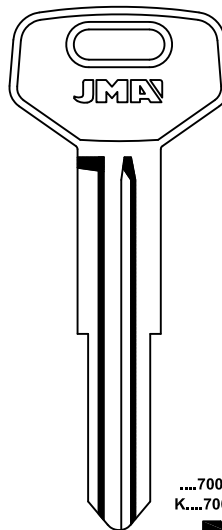

TOYOTA  
TOKAJ-RIKA

....7001-9000  
K....7001-9000

TOYO-16

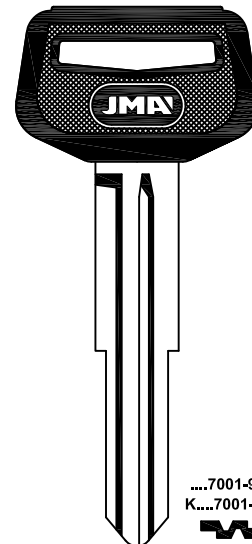

TOYOTA  
TOKAJ-RIKA

....7001-9000  
K....7001-9000

TOYO-16.P

TOYOTA

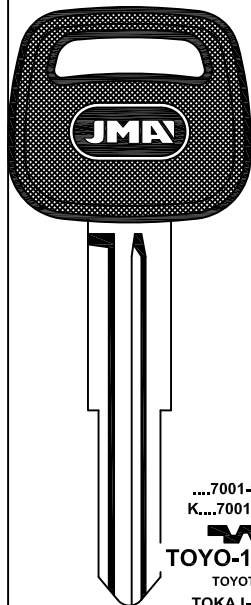

....7001-9000  
K....7001-9000

TOYO-16.P1

TOYOTA  
TOKAJ-RIKA

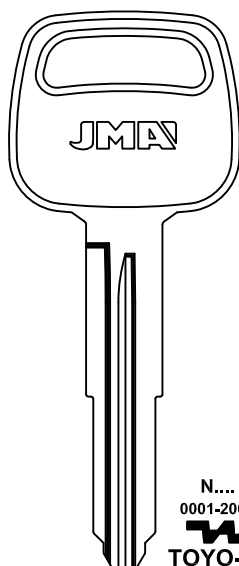

TOKAJ-RIKA

N....  
0001-2000

TOYO-17

TOYOTA

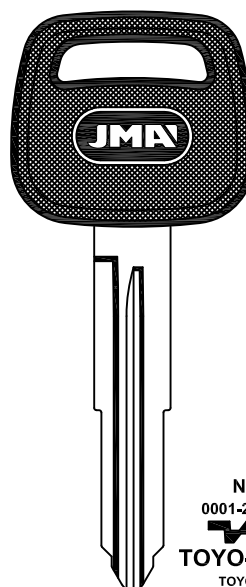

TOKAJ-RIKA

N  
0001-2000

TOYO-17.P

TOYOTA



LAT.  
1 7,8  
3

TOYO-18.P

LEXUS-MAZDA-TOYOTA  
TOKAJ-RIKA

TOYOTA

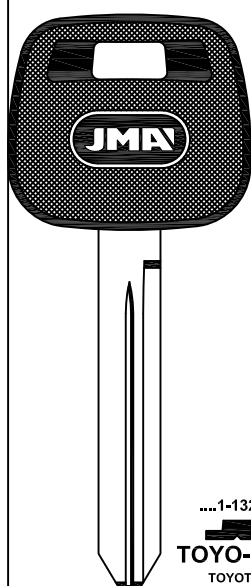

....1-13284

TOYO-19.P

TOYOTA  
VALEO

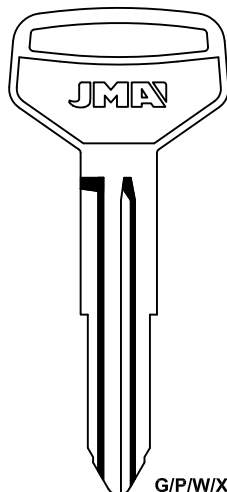

TOYOTA-VOLKSWAGEN  
TOKAJ-RIKA

G/P/W/X....  
1-2000

TOYO-20D

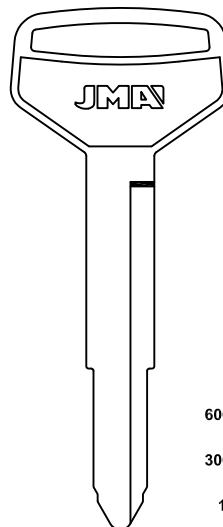

TOYOTA  
TOKAJ-RIKA

C....  
6001-8042  
U....  
3001-4000  
Z....  
1-1000

TOYO-22

K....  
001-400/1511-1910  
2221-2620/3731-4570  
5001-6368  
R....  
401-800/1112-1510  
2621-3020/3331-3730  
5001-6924/8001-9368  
S....  
5951-6350/7061-7460  
8171-8570/9281-9680  
D....  
6001-7042

TOYO-22D





**TOYOTA**

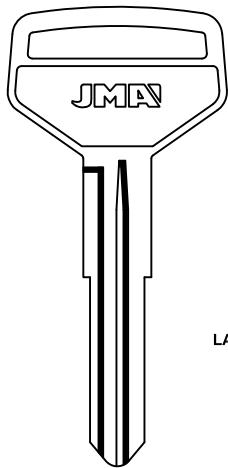

1001-2500  
3001-4500  
  
**TOYO-23**  
TOKAJ-RIKA

LAT.

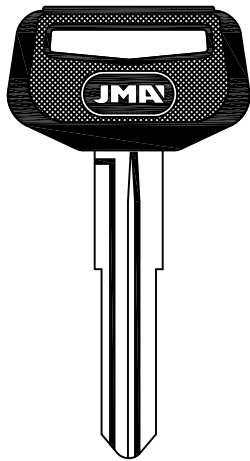

1001-2500  
3001-4500  
  
**TOYO-23.P**  
TOKAJ-RIKA

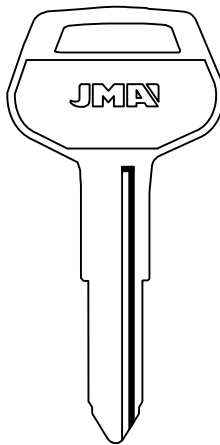

**TOYO-24**

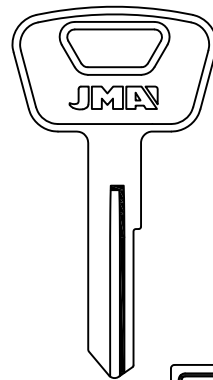

11121-15543  
51112-55424  
5....  
  
**TOYO-25**



**PARA-FOR:**  
TOYOTA (J)  
TRELOCK (D)  
TRIUMPH MOT.  
(USA)

**TOYOTA**

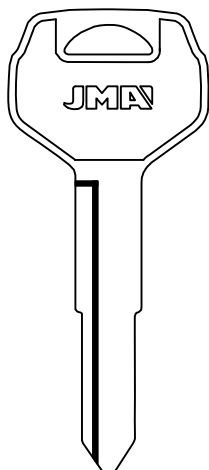

K....1-4130  
R....401-3790  
  
**TOYO-26**

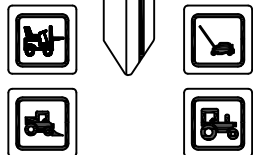
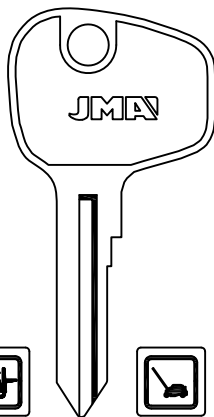

**TOYO-27**

HINO

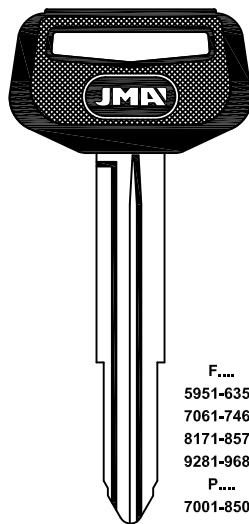

F....  
5951-6350  
7061-7460  
8171-8570  
9281-9680  
P....  
7001-8500  
  
**TOYO-28.P**

TOKAJ-RIKA

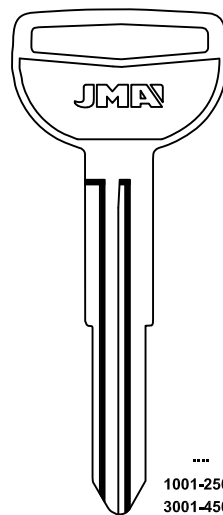

....  
1001-2500  
3001-4500  
  
**TOYO-29**

**TOYOTA**



7.8  
3  
  
**TOYO-30.P1**

LAT.

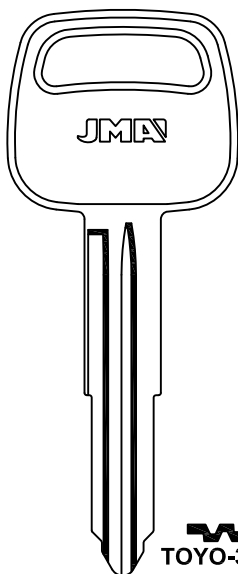

**TOYO-37D**

**TRELOCK**

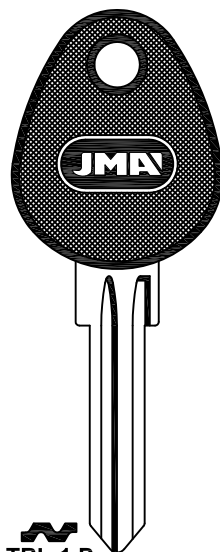

**TRL-1.P**

**TRIUMPH MOT.**

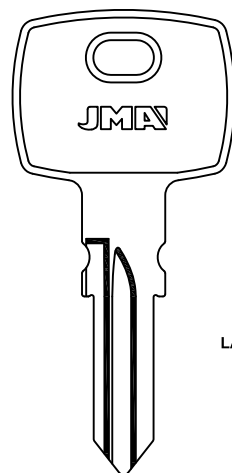

**TRP-1D**

LAT.



ZADI







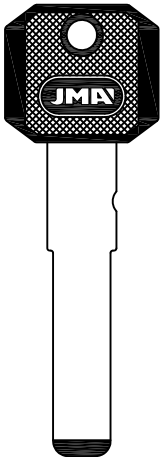





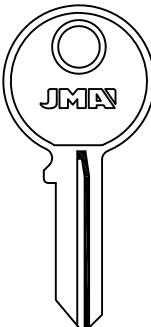





**PARA-FOR:**

TRW-SIPEA (I)



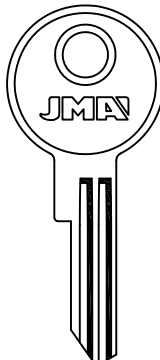
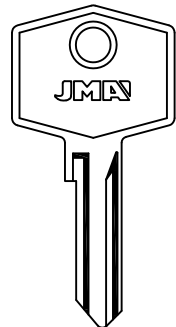



UNION (GB)

TRW-SIPEA		UNION	
	ALP.		LAT.
	FI-16C1		FI-16.P1
			GIOBERT

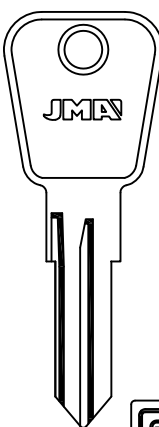
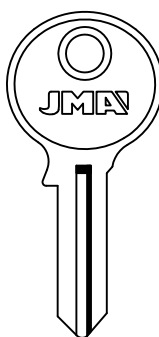
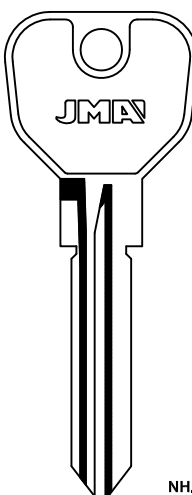
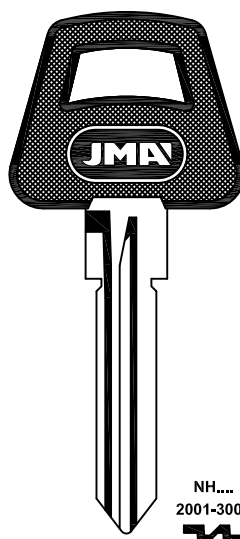
**UNION**

	<p>NRA FFE...1-100 FJA...1-100 FL...251-500 NRA...51-90 YFB...1-75 FMD...1-75 FG...1-30 NF...1-30 EJR...1-75</p> <p> UN-FFE</p> <p>MC...1-40 MRA...251-290 MRN...1-54 MRN...201-250 MRN...251-300</p> <p> UN-MRN</p> <p>FS...1-99 FS...876-955</p> <p> UN-1FS</p>	<p> </p> <p> UN-3</p> <p>FP... 626-750</p> <p> UN-FP</p> <p>FR... 751-875</p> <p> UN-FR</p> <p>HX...100</p> <p> UN-2</p> <p>RM... 911-952</p> <p> UN-44D</p> <p>NGN...1-54</p> <p> UN-NG</p>		
	<p>BRITISH LEYLAND-FORD-HILLMAN-JAGUAR-LAND ROVER-MG-MORRIS-ROVER</p>		<p> </p> <p>FK... 01-99 876-955</p> <p> UN-FK</p> <p>FS... 01-99 876-955</p> <p> UN-FS</p> <p>JAGUAR-VAUXHALL</p>	

**UNION**

			
<p>FT-BC...301-360 BC-FT...101-225 LF...451-575 CB...801-875</p> <p> UN-FT</p> <p>BEDFORD-B.LEYLAND-FORD CEM</p>	<p>TF TF...1001-1140</p> <p> UN-TF</p> <p>NC... 1-1000</p> <p> UN-NC</p>	<p>NH... 2001-3000</p> <p> UN-NH</p> <p>MG-ROVER-TRIUMPH CEM</p>	<p>NH... 2001-3000</p> <p> UN-NH.P</p> <p>MG-ROVER-TRIUMPH CEM</p>



## VACHETTE

PARA-FOR:

VACHETTE (F)

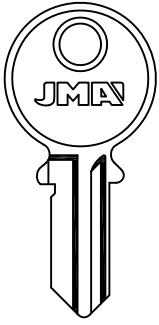

....1 AL 9 AL 0

E...9001-9100

....R9001-9100



VA-3I



VA-3

ISEO-KLIT

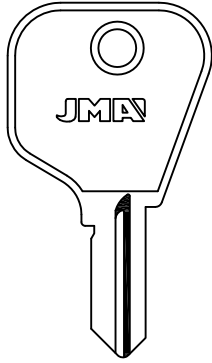

E...

001-649



VA-6

CITROEN-PEUGEOT-TALBOT SIMCA

SIMPLEX

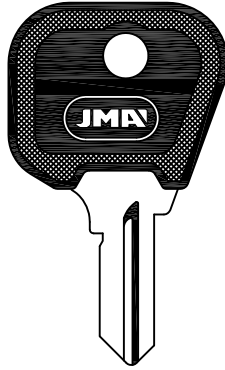

E...

001-649



VA-6.P

CITROEN-PEUGEOT-TALBOT SIMCA

SIMPLEX

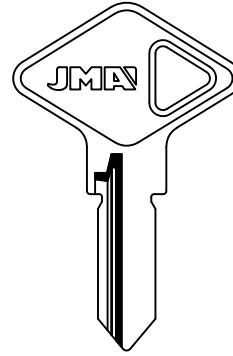

1R...000-999

2R...1000-1837

3R...000-665



VA-7

RENAULT-TALBOT SIMCA

## VACHETTE

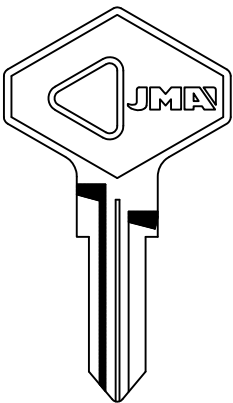

A/Z...

....A/Z

....A/Z 1/9

2700-4816



VA-10

A.MOTORS-CHRYSLER-RENAULT

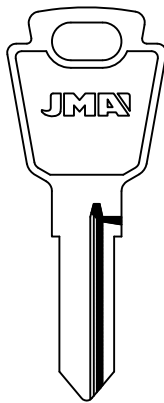

A...000-999

B...000-999

F...000-116



VA-16

TALBOT SIMCA

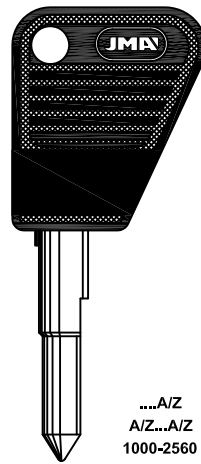

LAT.

....A/Z

A/Z...A/Z

1000-2560

.E...A/Z 0 AL 4



VA-17.P

RENAULT  
NEIMAN

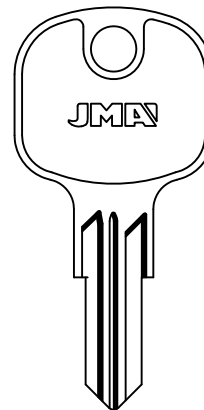

...E

001-649



VA-18

PEUGEOT

## VACHETTE

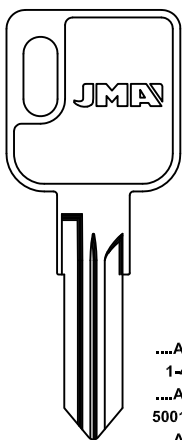

....A/Z 0/9

1-4092

....A/Z 0/9

5001-9092

....A/Z 0/9

1-4092

....A/Z 0/9

5001-9092



VA-34

RENAULT

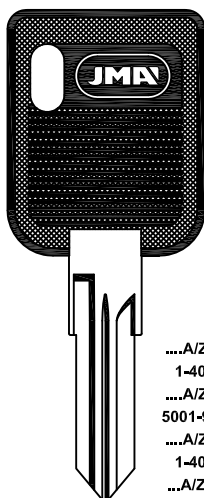

....A/Z 0/9

1-4092

....A/Z 0/9

5001-9092

....A/Z 0/9

1-4092

....A/Z 0/9

5001-9092



VA-34.P

RENAULT

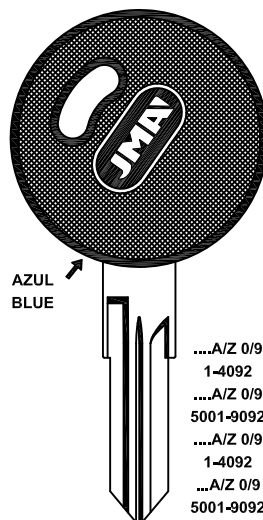

AZUL  
BLUE

....A/Z 0/9

1-4092

....A/Z 0/9

5001-9092

....A/Z 0/9

1-4092

....A/Z 0/9

5001-9092



VA-34.P1

RENAULT



....A/Z 0/9

1-4092

....A/Z 0/9

5001-9092

....A/Z 0/9

1-4092

....A/Z 0/9

5001-9092



VA-61C1

**JMA**<sup>®</sup>

Copyright by Alejandro Altuna S.A. 2014



ATENCIÓN: Concerniente a las marcas y denominaciones comerciales ver nota en índice.

ATTENTION: Concerning the marks and commercial denominations see note in index.

ATTENTION: Concernant les marques et dénominations commerciales voir la note dans l'index.

ACHTUNG: Beziehen auf die marke und handelsname sehen sie die notiz im index.











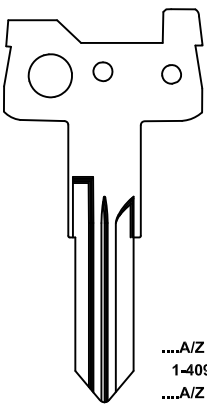



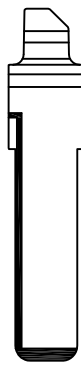



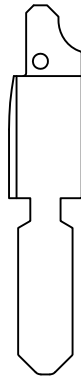

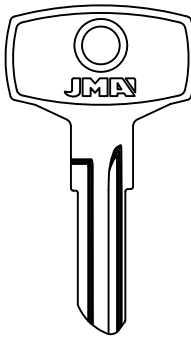

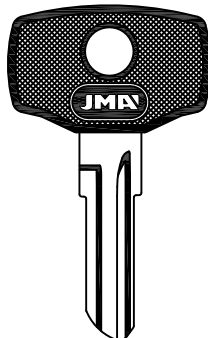

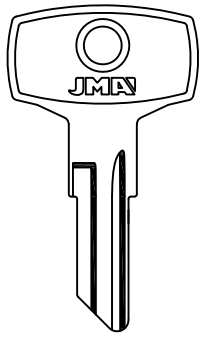

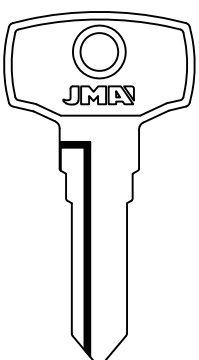

**PARA-FOR:**

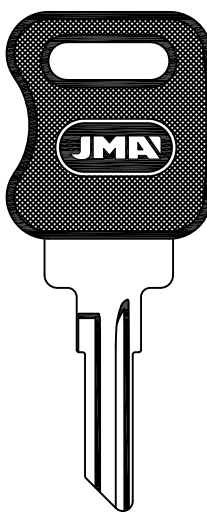
VACHETTE (F)

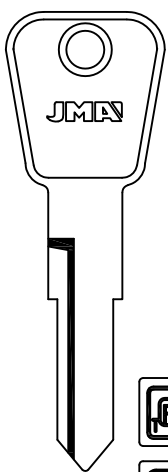
VALEO (F)

VOLGA (RUS)

WASO (D)

VACHETTE	VALEO		
 <p>....A/Z 0/9 1-4092 ....A/Z 0/9 5001-9092 ....A/Z 0/9 1-4092 ...A/Z 0/9 5001-9092</p>  <p><b>VA-61C2</b></p>	 <p>ALP.</p>  <p><b>HU-HAAC3</b></p>	 <p>ALP.</p>  <p><b>HU-HAAC4</b></p>	 <p>ALP.</p>  <p><b>PEU-1C1</b></p>
VALEO	VOLGA		
 <p>ALP.</p>  <p><b>PEU-2C1</b></p>	 <p><b>JMA</b></p>  <p><b>VOL-1</b></p>	 <p><b>JMA</b></p>  <p><b>VOL-1.P</b></p>	 <p><b>JMA</b></p>  <p><b>VOL-2</b></p>  <p><b>VOL-2D</b></p>  <p><b>VOL-3</b></p> <p>GAZ-ZAZ</p>
VOLGA		WASO	
 <p><b>JMA</b></p>  <p><b>VOL-4</b></p>	 <p><b>JMA</b></p>  <p><b>VOL-5.P</b></p>	 <p><b>JMA</b></p>   <p>W... 600-842</p>  <p><b>WAS-1</b></p> <p>JAGUAR-ROVER-SAAB-VOLVO</p>	 <p><b>JMA</b></p> <p>FR...4001-6000 FZ...1-1232</p>  <p><b>WAS-2.P</b></p> <p>JAGUAR-MAZDA-SUBARU-TRIUMPH ARMAN-DOM</p>



## WASO

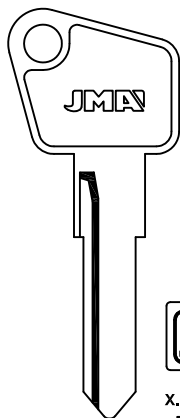

X...1-4088



**WAS-3**

D...1-4088

X...1-4088



**WAS-4**

DAF

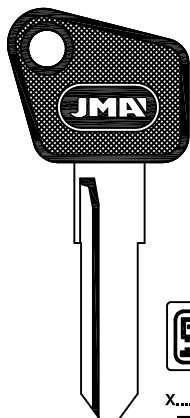

X...1-4088



**WAS-3.P**

D...1-4088

X...1-4088



**WAS-4.P**

DAF

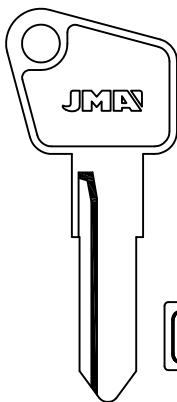

W...600-842



**WAS-5**

M...100-174



**WAS-6**

LOTUS-BEDFORD-DAF

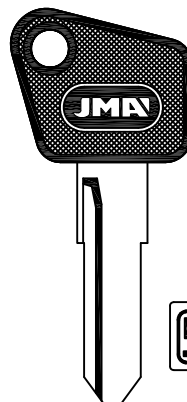

W...600-842



**WAS-5.P**

M...100-174



**WAS-6.P**

LOTUS-BEDFORD-DAF

## PARA-FOR:

WASO (D)

WEST LOCK (USA)

WITTE (D)

YALE (D-GB-USA)

## WASO

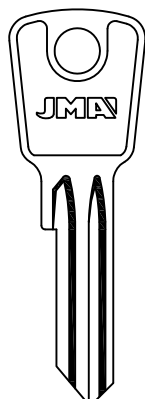

A.....

0 AL 5



**WAS-7I**

TOK

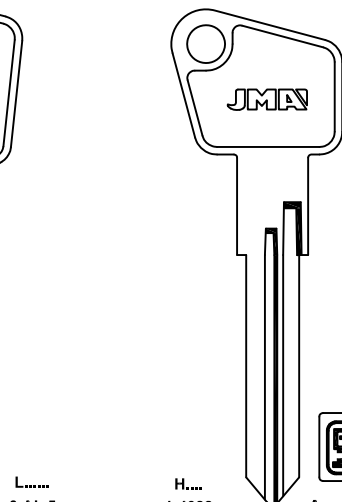

L.....

0 AL 5



**WAS-7D**

UNIPART

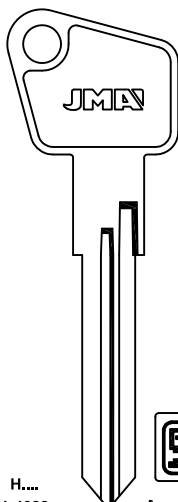

H.....

1-4088



**WAS-8**

A.....

0 AL 5



**WAS-8D**

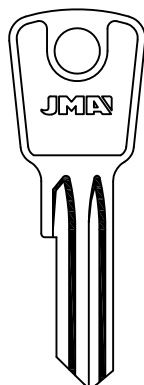

B.....

L.....

0 AL 5



**WAS-9**

TOK WINKHAUS

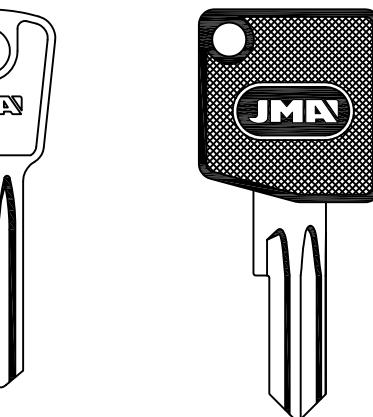

B.....

L.....

0 AL 5



**WAS-10.P**

TRELOCK



B.....

L.....

0 AL 5



**WAS-10D.P**

## WEST LOCK

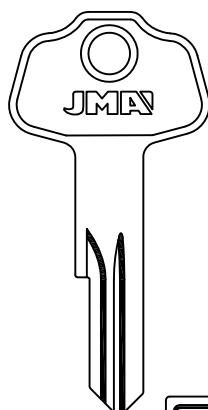

V.....

1 AL 6



**WST-1D**

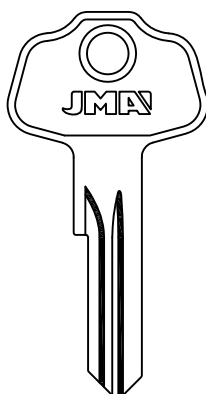

V.....

1 AL 6



**WST-2D**

## WITTE

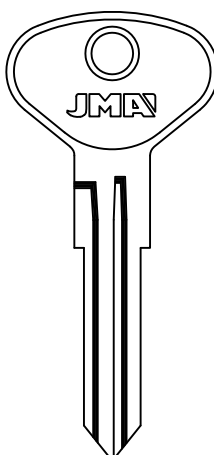

8001-8100



**WIT-1**

## YALE

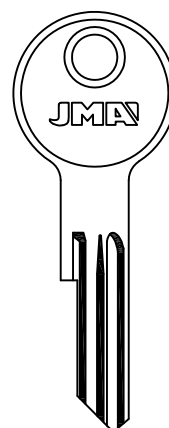

RRL



**YA-18D**

ROLLS ROYCE



**PARA-FOR:**  
 YALE (D-GB-USA)  
 YAMAHA (J)

**YALE**

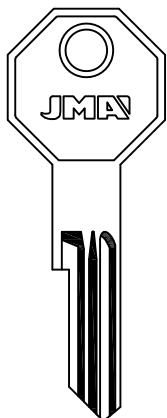

RRM  
 YA-19D  
 ROLLS ROYCE

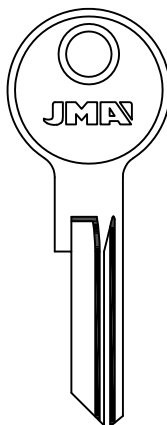

NRRL  
 YA-20I YA-20D  
 ROLLS ROYCE

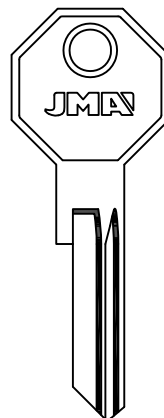

NRRM  
 YA-21I YA-21D  
 ROLLS ROYCE

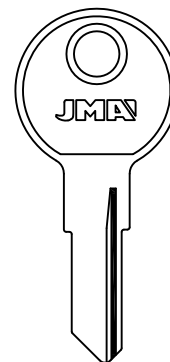

  
 YA-37 YA-37D  
 ADEMCO-BENDIX-CHICAGO  
 FORT-ILLINOIS

**YAMAHA**

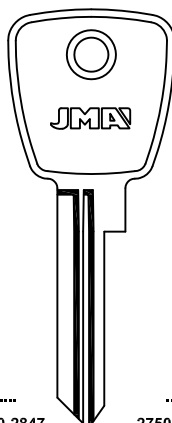

....  
 2840-2847  
 YAMA-1I  
 2550-2557  
 YAMA-2I  
 YAMAHA

....  
 2750-2757  
 YAMA-1D  
 2640-2647  
 YAMA-2D  
 YAMAHA

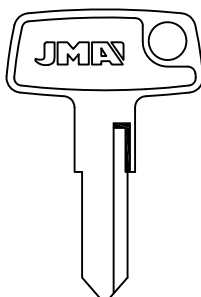

....  
 2611-2650  
 YAMA-3I  
 YAMAHA

....  
 1711-1725  
 YAMA-3D  
 YAMAHA

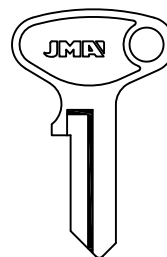

....  
 YAMA-4D  
 YAMAHA

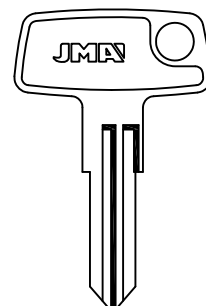

....  
 2651-2675  
 YAMA-5I  
 YAMAHA

....  
 1751-1775  
 YAMA-5D  
 YAMAHA

**YAMAHA**

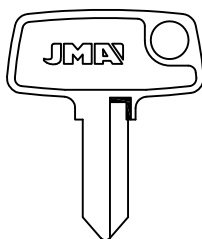

....  
 228-234  
 YAMA-6I  
 YAMAHA

....  
 221-227  
 YAMA-6D  
 YAMAHA

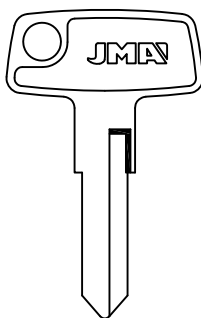

....  
 2676-2700  
 YAMA-7I  
 YAMAHA

....  
 1776-1800  
 YAMA-7D  
 YAMAHA

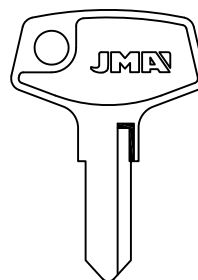

....  
 2109-2115  
 6201-6212  
 YAMA-8I  
 YAMAHA

....  
 1209-1215  
 1711-1725  
 6101-6112  
 YAMA-8D  
 YAMAHA

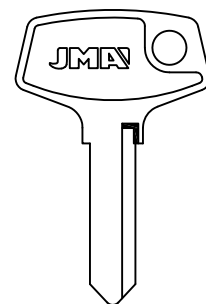

....  
 A201-A206  
 B201-B206  
 YAMA-9I  
 YAMAHA

....  
 A101-A106  
 B101-B106  
 YAMA-9D  
 YAMAHA



# YAMAHA

PARA-FOR:

YAMAHA (J)

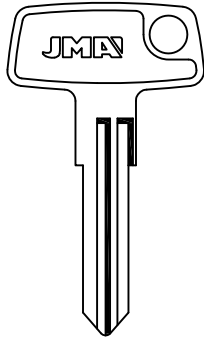

....  
2765-2771  
  
**YAMA-10I**

....  
1855-1861  
  
**YAMA-10D**

....  
2758-2764  
  
**YAMA-11I**

....  
1848-1854  
  
**YAMA-11D**

YAMAHA

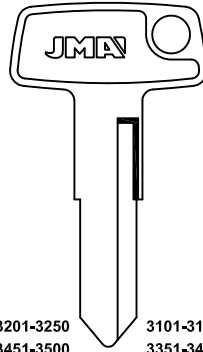

3201-3250  
3451-3500  
4401-4450

**YAMA-12I**

3101-3150  
3351-3400  
4301-4350

**YAMA-12D**

3251-3300  
3851-3900  
4451-4500

**YAMA-13I**

3151-3200  
3751-3800  
4351-4400

**YAMA-13D**

YAMAHA

3801-3850  
4251-4300  
4851-4900

**YAMA-14I**

3401-3450  
4051-4100  
4651-4700

**YAMA-15I**

3651-3700  
4201-4250  
4801-4850

**YAMA-16I**

3601-3650  
4001-4050  
4601-4650

**YAMA-17I**

3701-3750  
4151-4200  
4751-4800

**YAMA-14D**

3301-3350  
3951-4000  
4551-4600

**YAMA-15D**

3551-3600  
4101-4150  
4701-4750

**YAMA-16D**

3501-3550  
3901-3950  
4501-4550

**YAMA-17D**

# YAMAHA

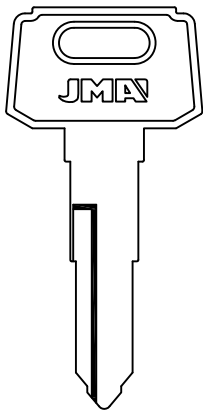

1 AL 4  
32010-79897

A.....  
32010-79897  
  
**YAMA-18I**

B.....  
32010-79897  
  
**YAMA-18D**

C.....  
32010-79897  
  
**YAMA-19I**

D.....  
32010-79897  
  
**YAMA-19D**

E.....  
32010-79897  
  
**YAMA-20I**

F.....  
32010-79897  
  
**YAMA-20D**

MALAGUTI-SUZUKI-YAMAHA

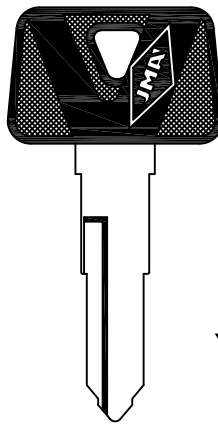

1 AL 4  
32010-79897

A.....  
32010-79897  
  
**YAMA-18I.P**

B.....  
32010-79897  
  
**YAMA-18D.P**

C.....  
32010-79897  
  
**YAMA-19I.P**

D.....  
32010-79897  
  
**YAMA-19D.P**

E.....  
32010-79897  
  
**YAMA-20I.P**

F.....  
32010-79897  
  
**YAMA-20D.P**

MALAGUTI-SUZUKI-YAMAHA

# YAMAHA

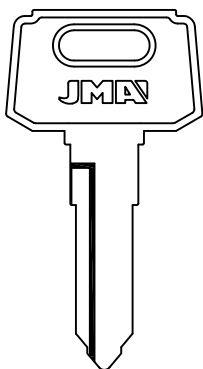

....  
7001-8000  
  
**YAMA-21I**

HERCULES-YAMAHA

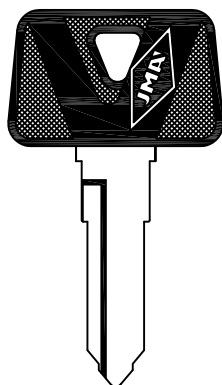

....  
7001-7999  
  
**YAMA-21I.P**

HERCULES-YAMAHA

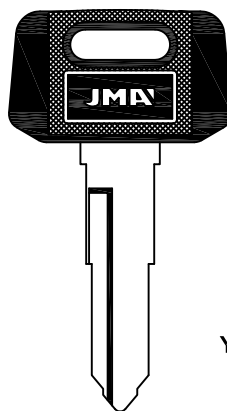

1 AL 4  
32010-79897

A.....  
32010-79897  
  
**YAMA-22I.P**

B.....  
32010-79897  
  
**YAMA-22D.P**

C.....  
32010-79897  
  
**YAMA-23I.P**

D.....  
32010-79897  
  
**YAMA-23D.P**

E.....  
32010-79897  
  
**YAMA-24I.P**

F.....  
32010-79897  
  
**YAMA-24D.P**

YAMAHA





**PARA-FOR:**

YAMAHA (J)

YUGO (YU)

YMS (TW)

ZADI (I)

**YAMAHA**

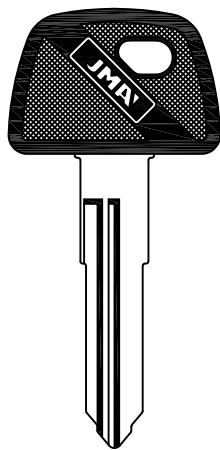

....  
6001-7000

**YAMA-25D.P**  
PUCH-VESPA-YAMAHA

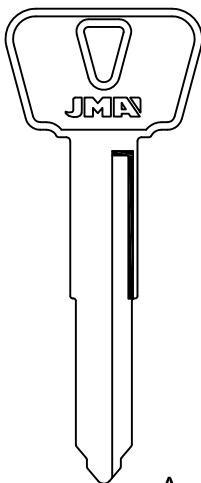

A....  
7000-8000

**YAMA-26**  
YAMAHA

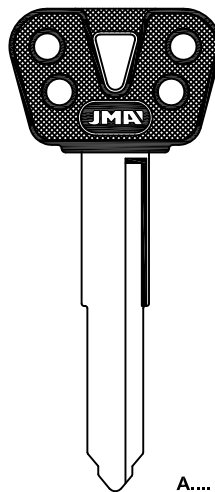

A....  
7000-8000

**YAMA-26P**  
YAMAHA

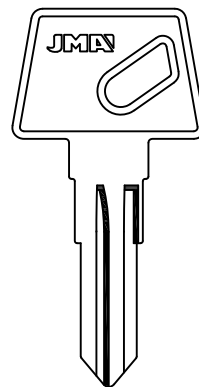

....3000

**YAMA-27**  
ITALJET-MALAGUTI-MBK-YAMAHA

....7000

**YAMA-27D**  
ITALJET-MALAGUTI-MBK-YAMAHA

**YAMAHA**

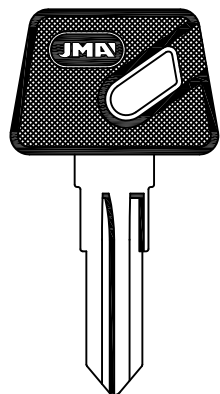

....3000 **YAMA-27P**  
....7000 **YAMA-27DP**

....4000 **YAMA-30.P**  
ITALJET-MALAGUTI-MBK-YAMAHA

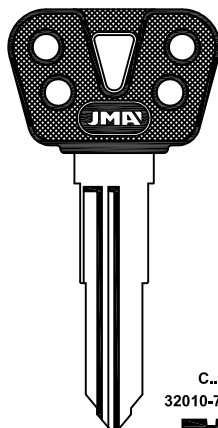

C....  
32010-79897  
 **YAMA-28.P**

E....  
32010-79897  
 **YAMA-29.P**  
YAMAHA

**YUGO**

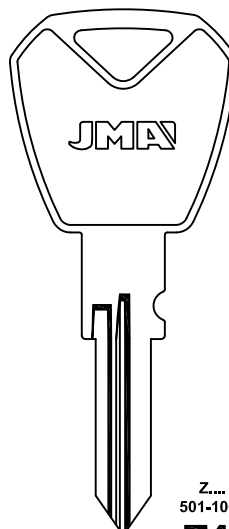

YUGO ZASTAVA

Z....  
501-1000  
 **YU-1D**

**YWS**

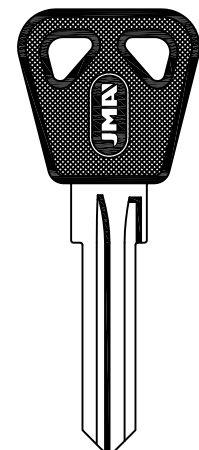

**YW-1.P**

ABUS

**ZADI**

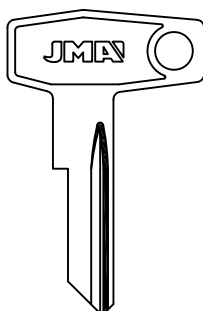

....1-1625  
....5001-6278  
E...1-710



**ZA-1**

BRETER

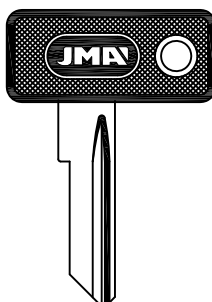

....1-1625  
....5001-6278  
E...1-710



**ZA-1.P**

BRETER

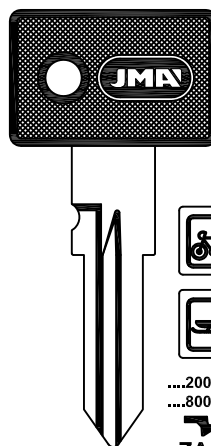

....2001-3554  
....8001-9554



**ZA-2.P**



**ZA-4D.P**

APRILIA-GILERA-PIAGGIO VESPA  
BASTA-VIRO

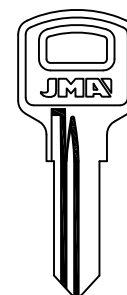

...1-390



**ZA-3D**



ZADI

PARA-FOR:

ZADI (I)

ZIL (RUS)

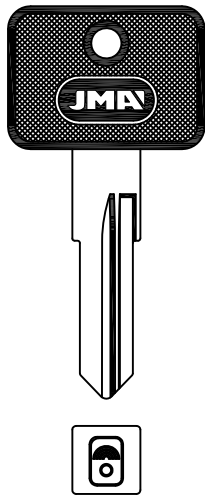

ZA-5.P ZA-5D.P

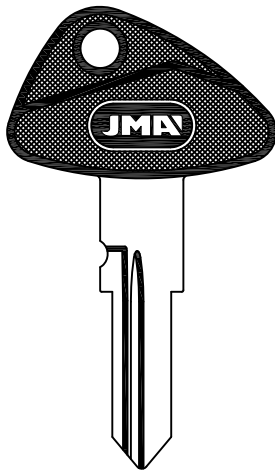

8001-9554  
ZA-6D.P  
BMW

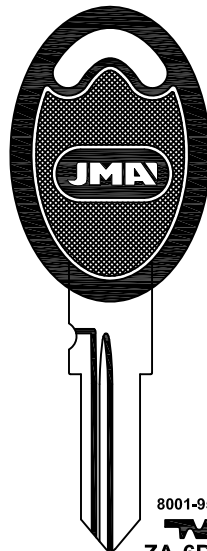

8001-9554  
ZA-6D.P1  
APRILIA-BETA

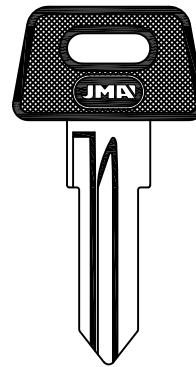

8001-9554  
ZA-7D.P  
GILERA-PIAGGIO

ZADI

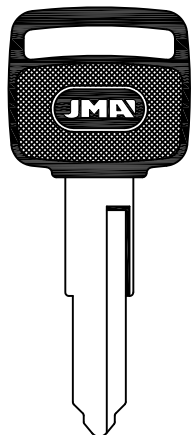

ZA-8.P

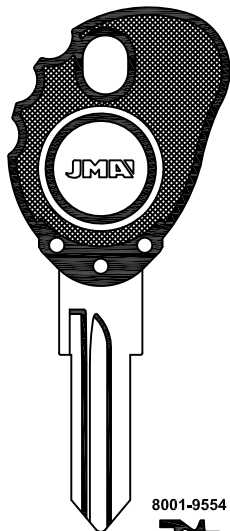

8001-9554  
ZA-9.P  
MALAGUTI-MBK

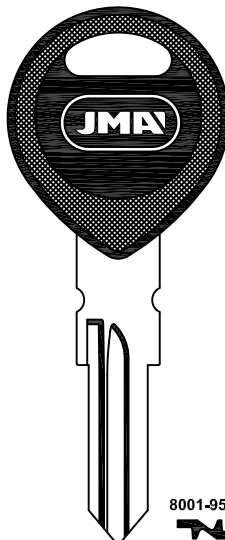

8001-9554  
ZA-9.P1  
PIAGGIO-MBK-YAMAHA

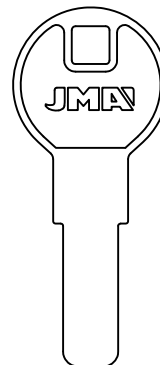

LAT.

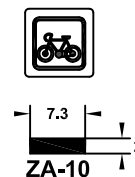

ZA-10

ZADI

ZIL

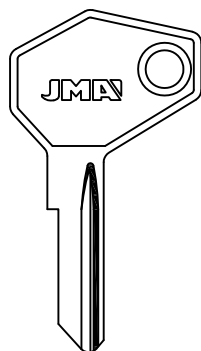

....1-1625  
....5001-6278  
E...1-710

ZA-12

BRETER

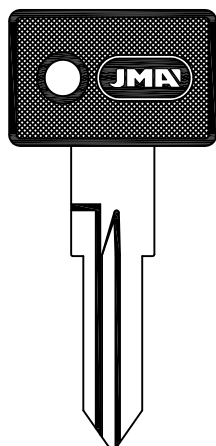

....5001-6475  
ZA-13.P

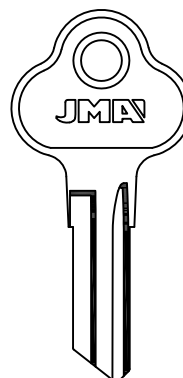

ZI-1



# **LLAVES DE CIERRE**

*IXTEKO GILTZAK*

*SNAP-LOCK KEYS*

*CLES DE BOUCHE D'EAU*

*DORNSCHLÜSSEL*



**THE KEY TO EXCELLENCE**  
GLOBALLY UNLOCKING MILLIONS OF DOORS DAILY

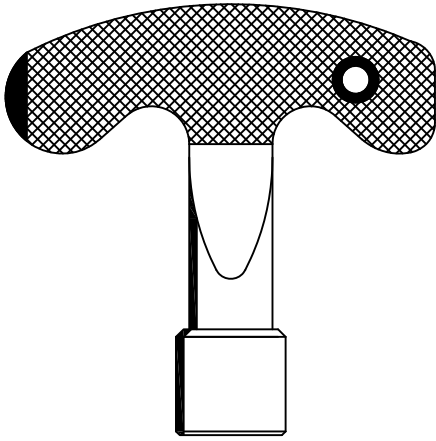

ZAM.

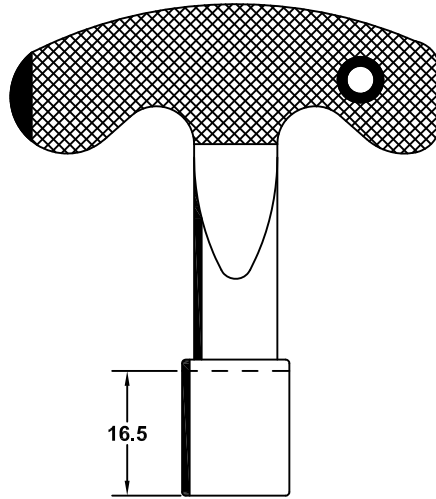

ZAM.



6  
500



7  
501



8  
502



10  
503



6  
504



8  
505



10  
506



8.5  
507



8  
508

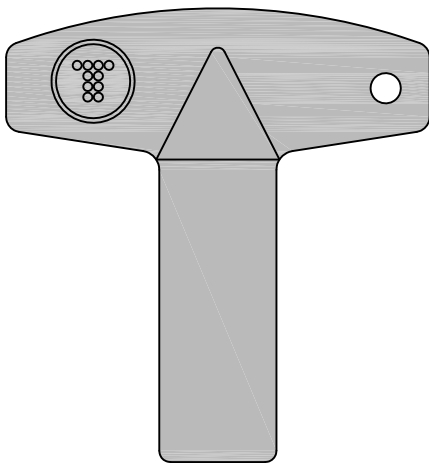

PLAS.

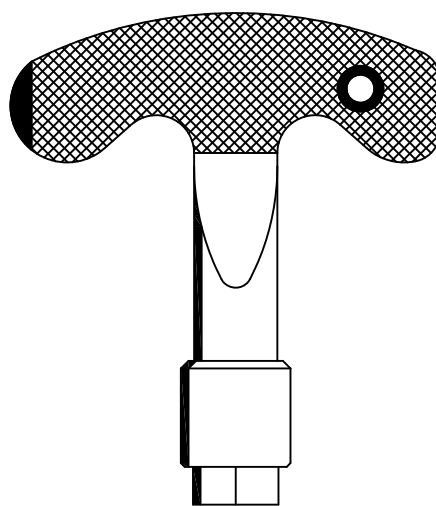

ZAM.

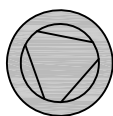

9.5  
509



8  
510



PARA-FOR:

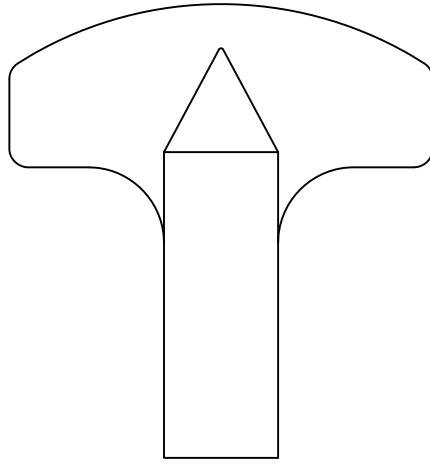

ALU.

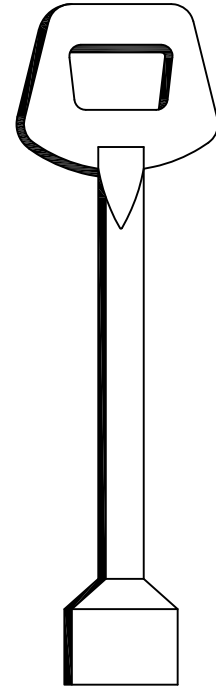

ZAM.



8.5  
511



10  
512

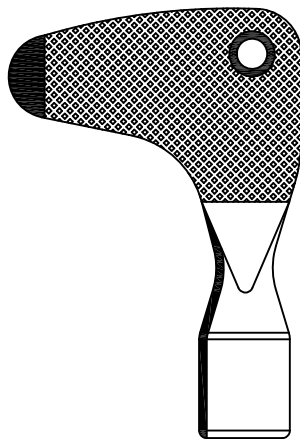

LAT.



8.5  
513  
ORONA



# **LLAVES EN CRUZ**

*GURUTZE-GILTZAK  
CRUCIFORM KEYS  
CLES CRUCIFORMES  
KREUTZSCHLÜSSEL*



**THE KEY TO EXCELLENCE**  
GLOBALLY UNLOCKING MILLIONS OF DOORS DAILY

**PARA-FOR:**







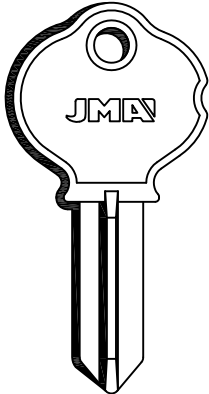
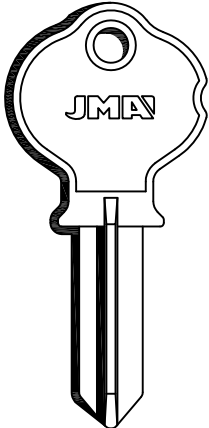
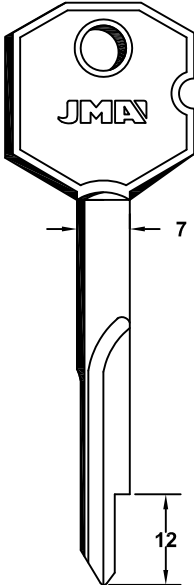
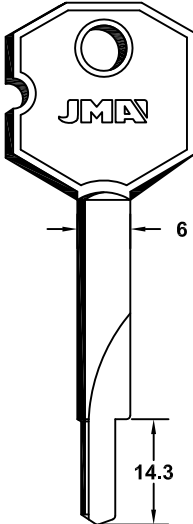

AGC (P)

ALA (I)

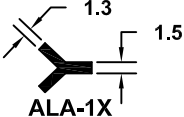
BLUMA (D)

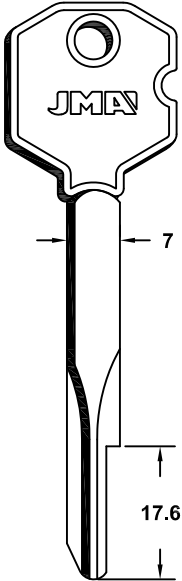
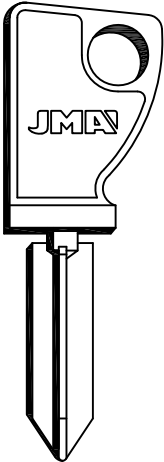
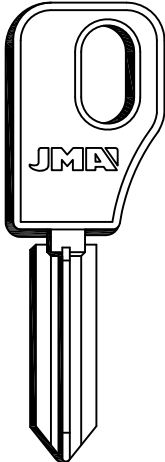
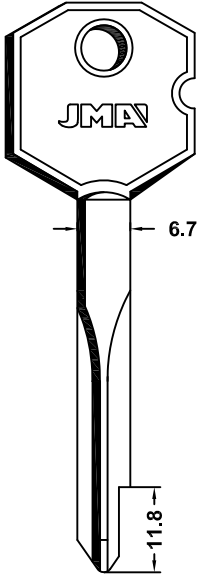
BRICARD (F)

BURG (D)

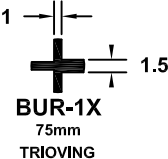
AGC		ALA	BLUMA
			
 AGD-1X CCF3	 AGD-2X CCF3	 ALA-1X	 BLU-1X
BLUMA	BRICARD		BURG
			
 BLU-2X	 BRI-1X	 BRI-2X	 BRI-3X
			 BUR-1X 75mm TRIOVING





## BURG

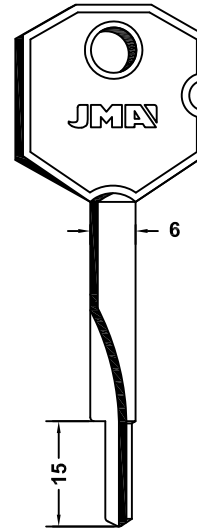
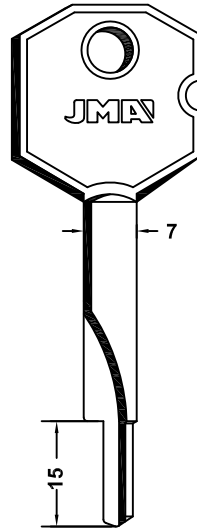
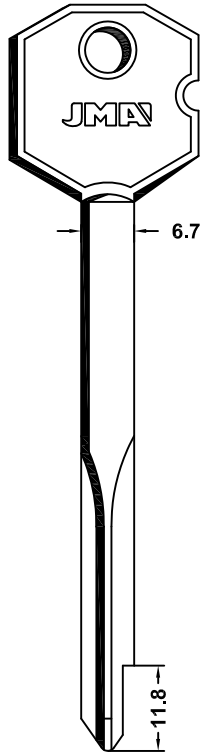
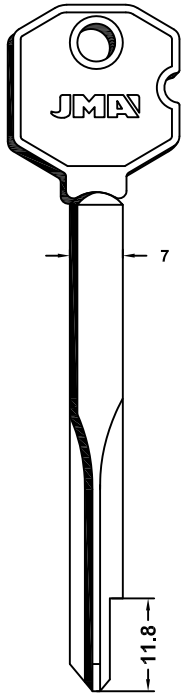

## PARA-FOR:

BURG (D)

CCF (P)

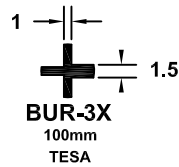
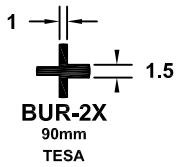



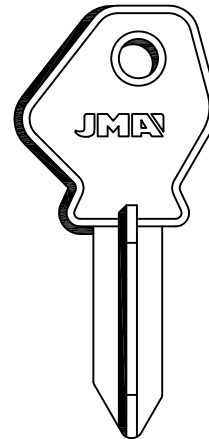
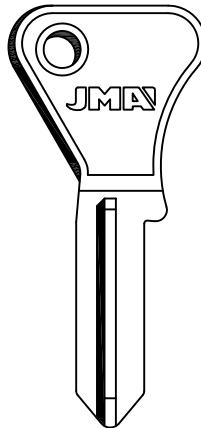
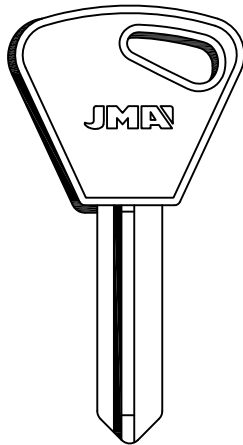
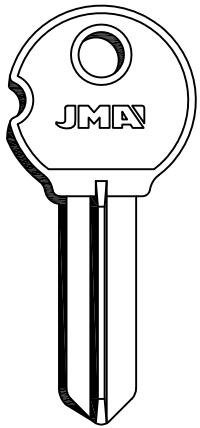

## CCF

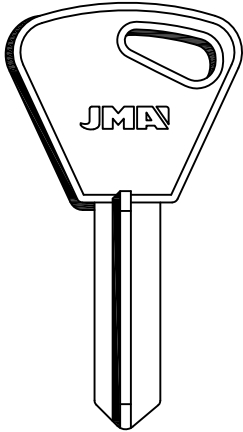
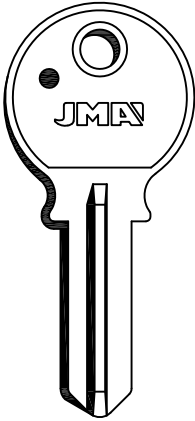
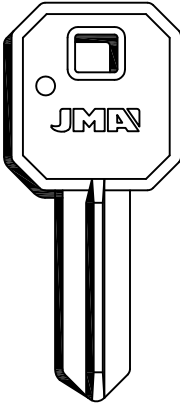
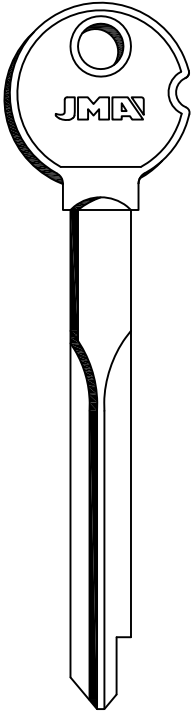

**PARA-FOR:**

- CCF (P)
- CIFIAL (P)
- CRC CAMBOA (P)
- DEBEAURAIN (F)
- DOOR LOCK
- FAYN (TR)
- FIAM (I)

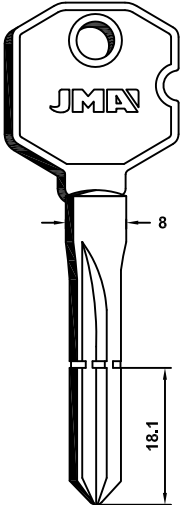
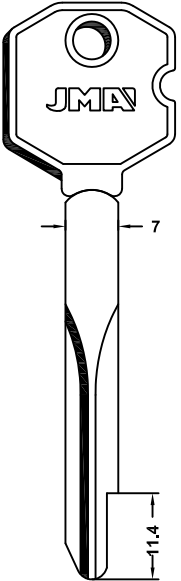
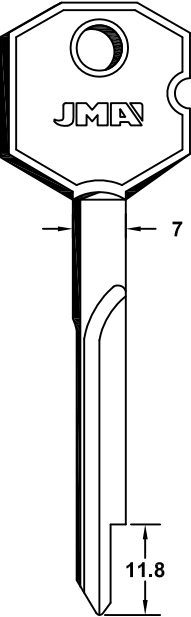
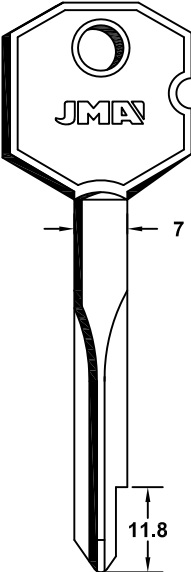
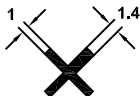
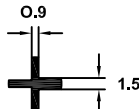
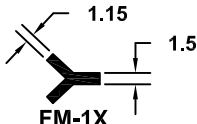
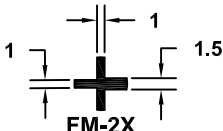
	CCF	CIFIAL	CRC CAMBOA	DEBEAURAIN
				
	 CCF-10X	 CIF-1X CCF4	 CRC-1X	 DEB-1X
DOOR LOCK	FAYN	FIAM		
				
 DOL-1X	 FAY-1X	 FM-1X	 FM-2X	



**FRIPA**

**GERA**

**PARA-FOR:**

- FRIPA (D)
- GERA (D)
- HELCO KFV (D)
- ISEO (I)

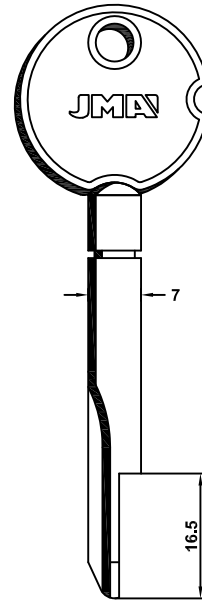
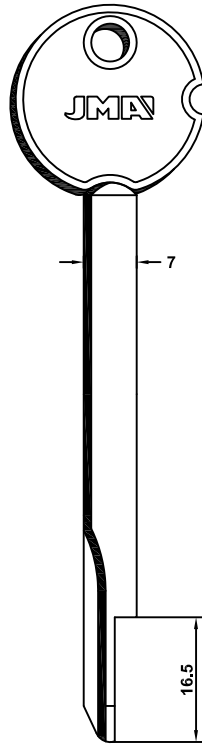
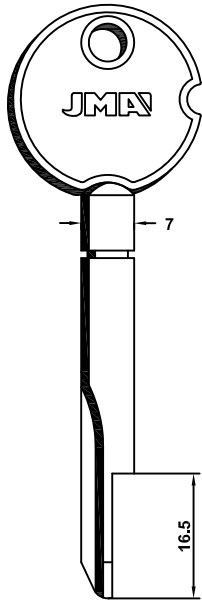
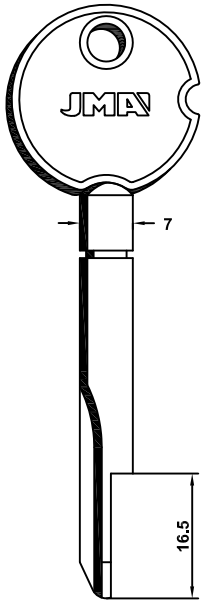

**FRI-1X**

GERA



**FRI-2X**

GERA

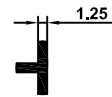

**GEA-1X**

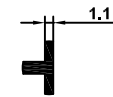

**GEA-3X**

**HELCO KFV**

**ISEO**

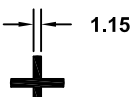
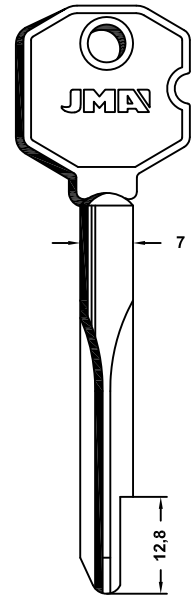
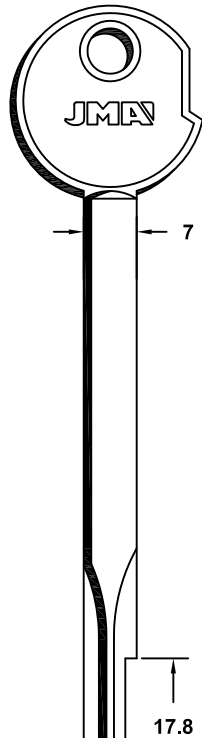
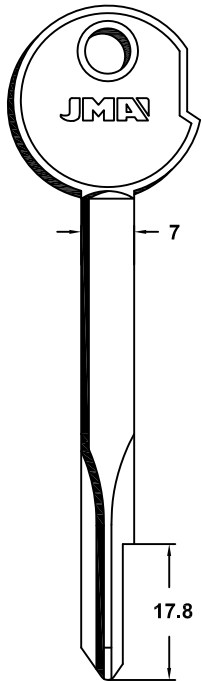
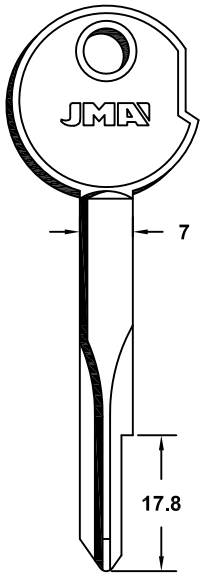

**KFV-1X**  
75mm

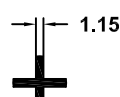

**KFV-2X**  
85mm

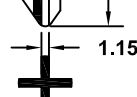

**KFV-3X**  
100mm

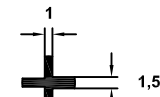

**IS-1X**



PARA-FOR:  
KRESTI (RUS)

KRESTI

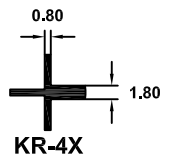
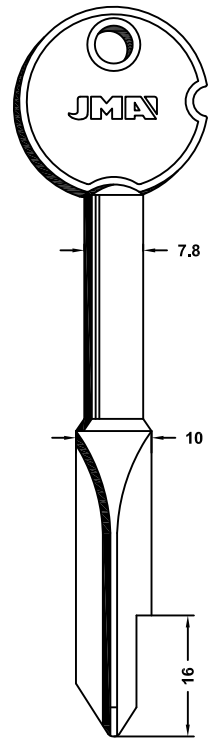
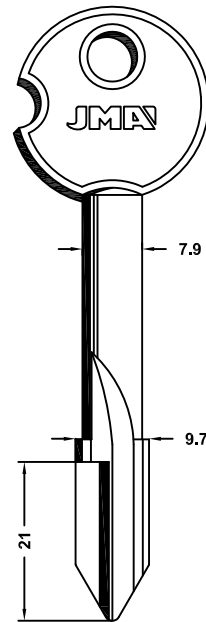
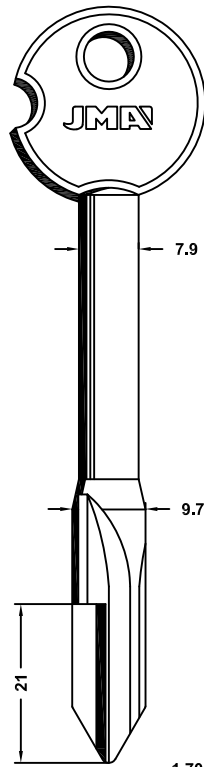
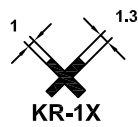
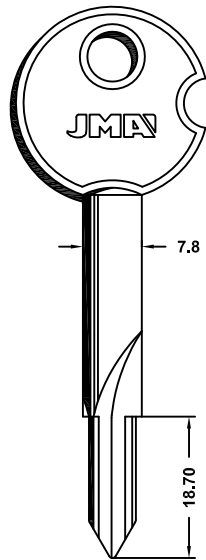

KRESTI

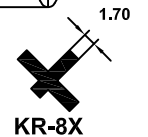
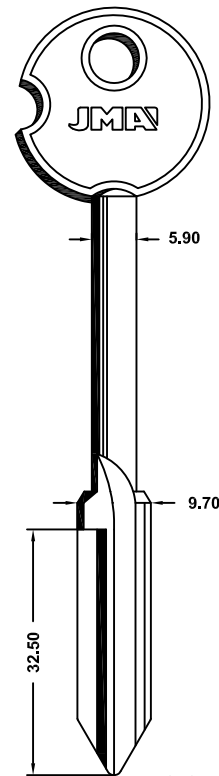
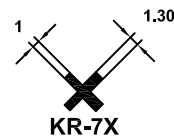
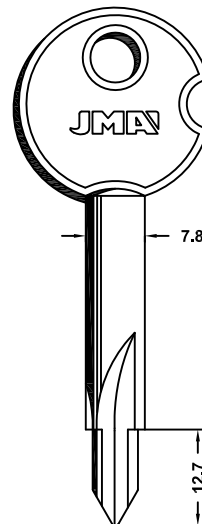
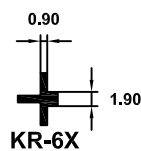
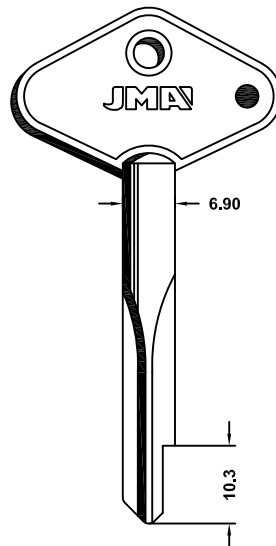
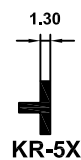
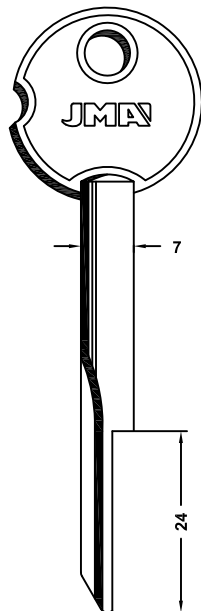

# KRESTI

PARA-FOR:

KRESTI (RUS)

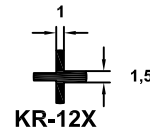
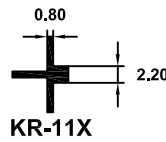
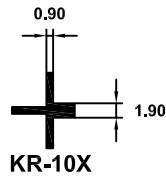
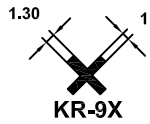
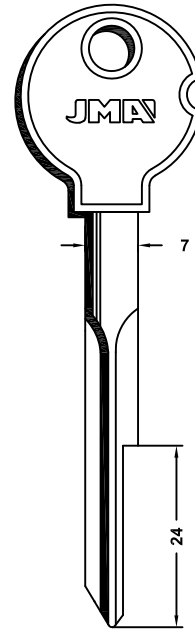
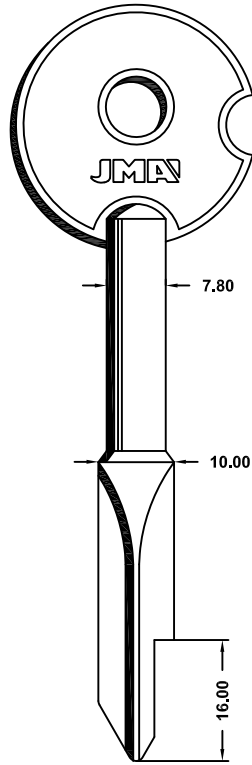
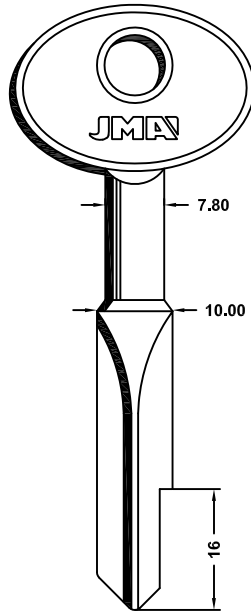
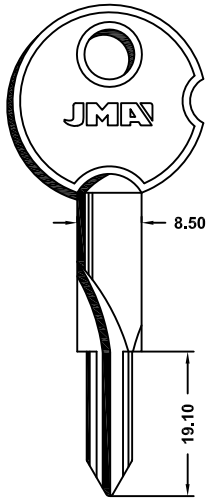

# KRESTI

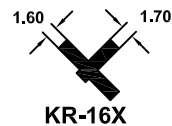
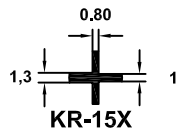
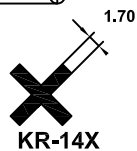
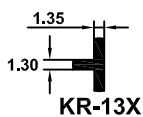
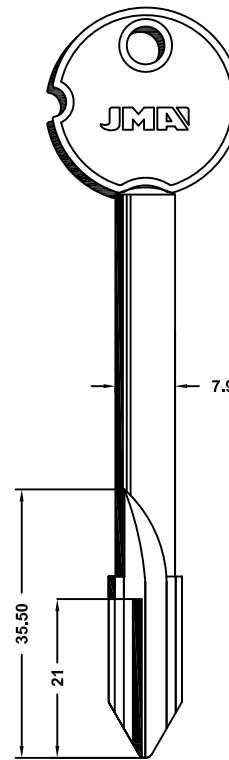
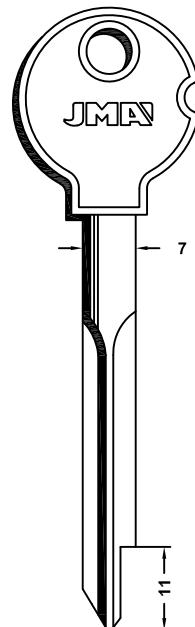
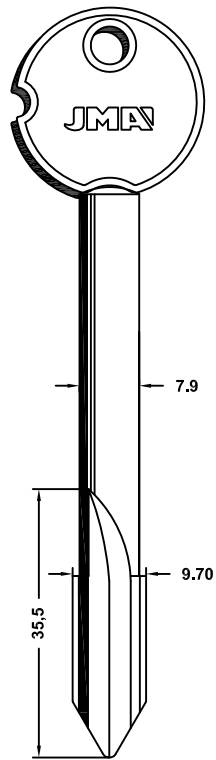
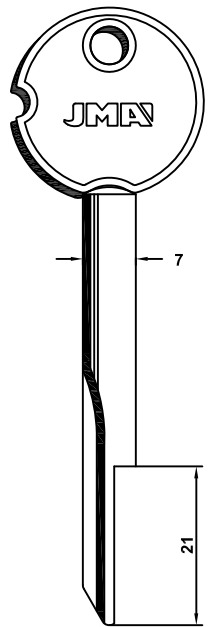

**PARA-FOR:**

KRESTI (RUS)

LOCK-IT (GB)

MAFOR (F)

MINI MOLA (P)

MOREAUX (F)

MSV (P)

NABOB (IL)

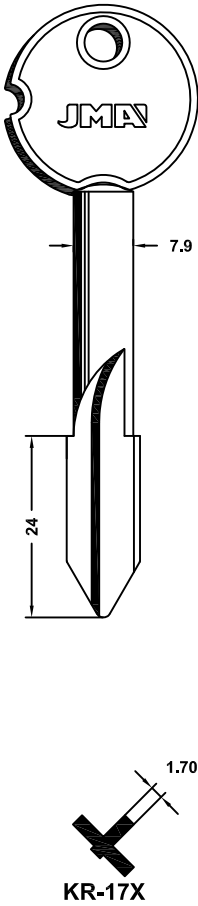
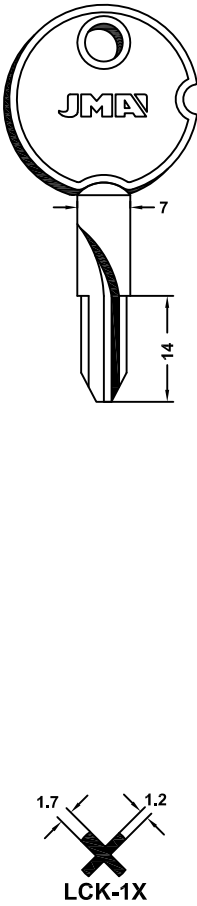
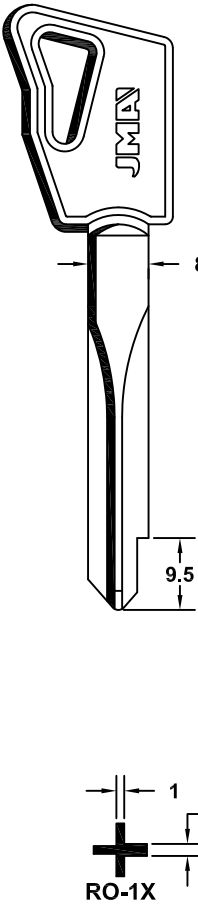
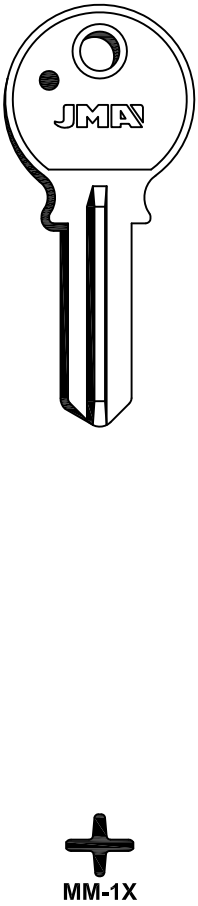
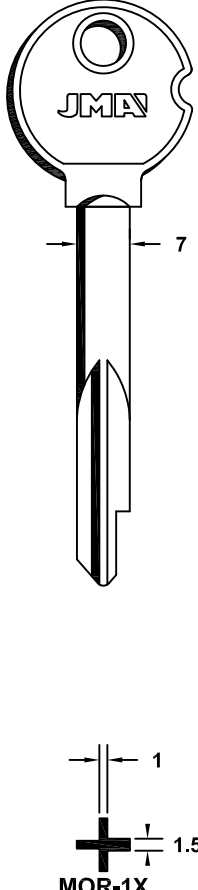
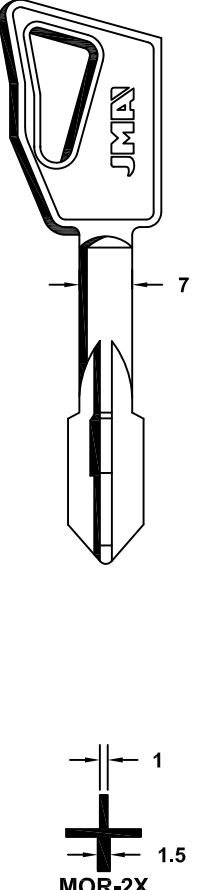
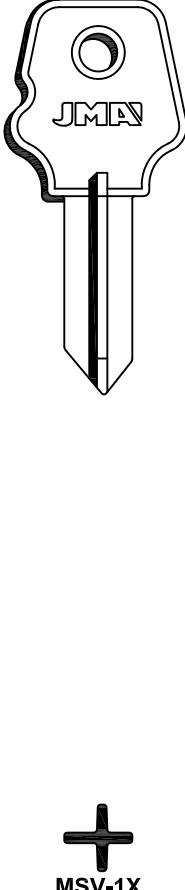
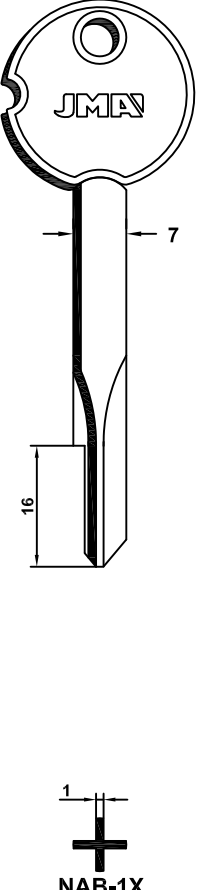
KRESTI	LOCK-IT	MAFOR	MINI MOLA
 <p>KR-17X</p>	 <p>LCK-1X</p>	 <p>RO-1X RONIS-SOS</p>	 <p>MM-1X CCF7 ANA</p>
MOREAUX		MSV	NABOB
 <p>MOR-1X</p>	 <p>MOR-2X</p>	 <p>MSV-1X</p>	 <p>NAB-1X</p>



**NEMEF**

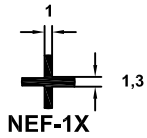
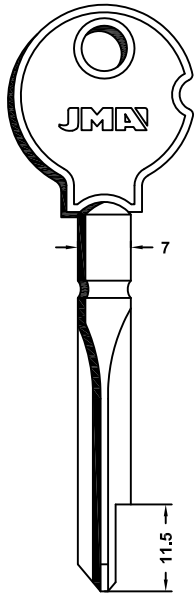

**PAPAIZ**

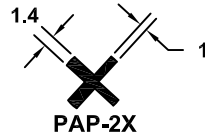
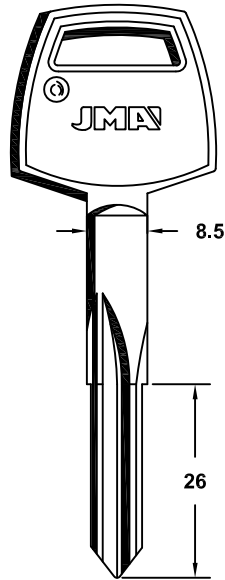
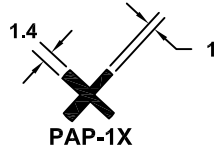
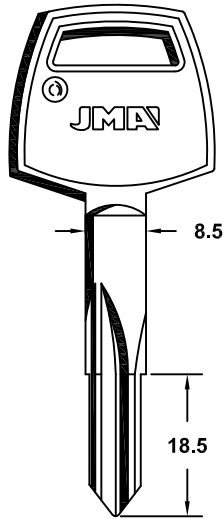

**TUFF**

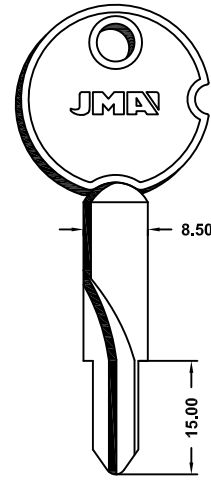

**PARA-FOR:**

- NEMEF (D)
- PAPAIZ (BR)
- TUFF (HK)
- UNIVERSAL
- YALE BKS (I-D)

**TUFF**

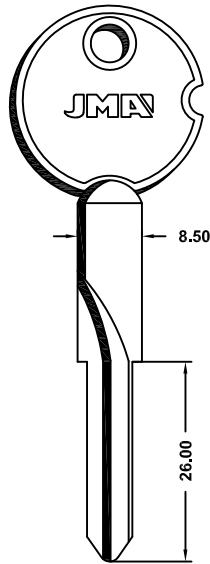
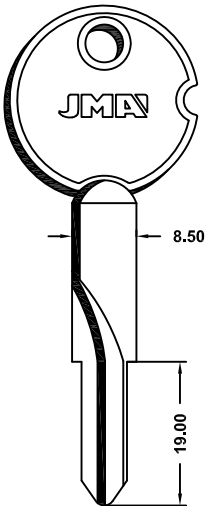

**UNIVERSAL**

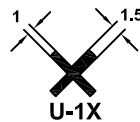
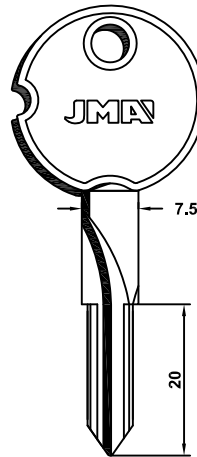

**YALE BKS**

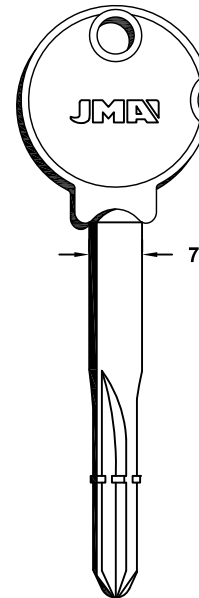



**PARA-FOR:**

YALE BKS (I-D)

ZEISS IKON (D)

**YALE BKS**

**YALE**

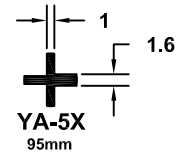
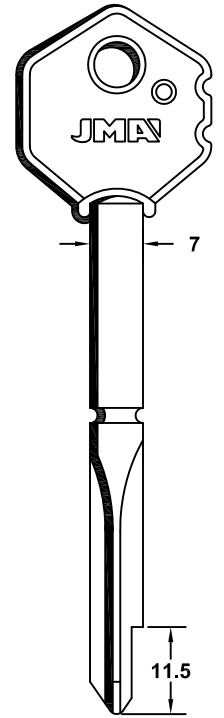
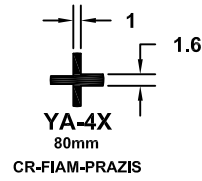
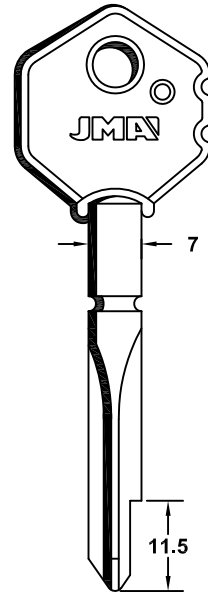
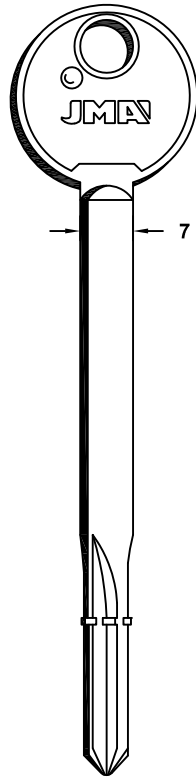
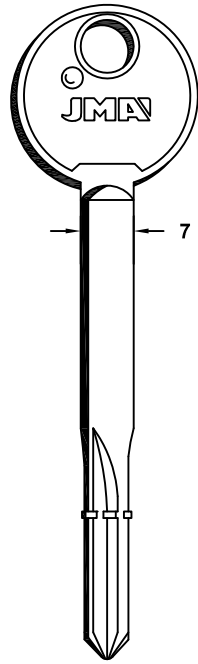

**YALE**

**ZEISS IKON**

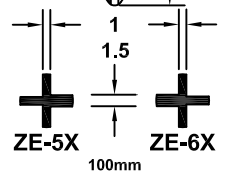
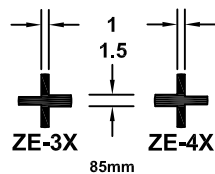
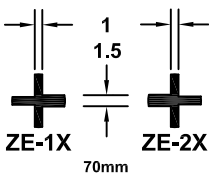
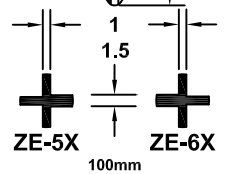
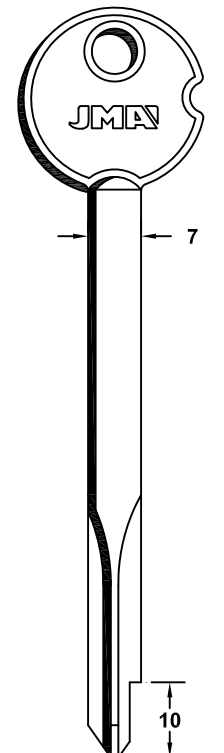
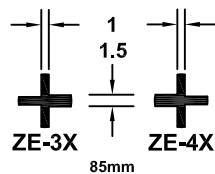
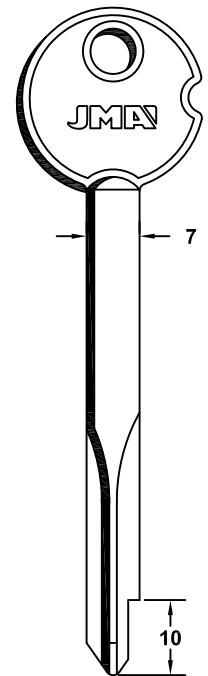
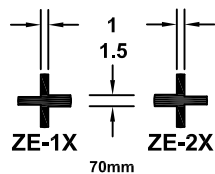
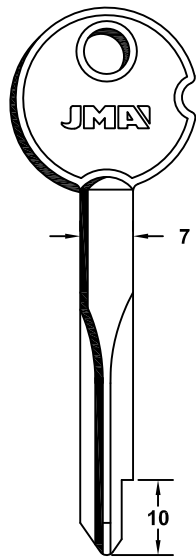
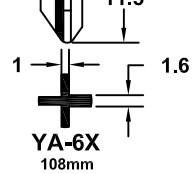
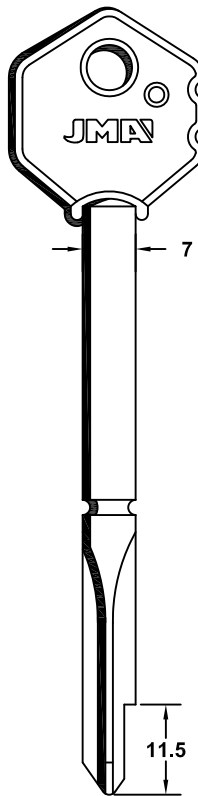

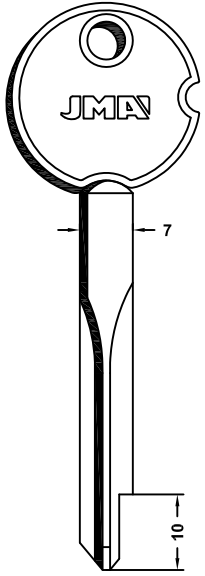

  
**ZE-7X**  
75mm

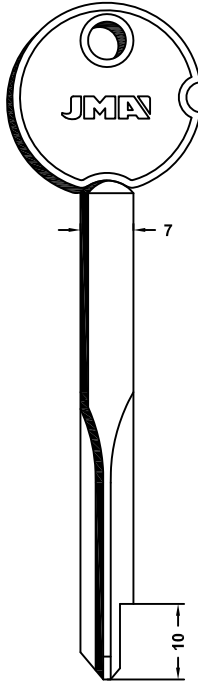

  
**ZE-8X**  
90mm

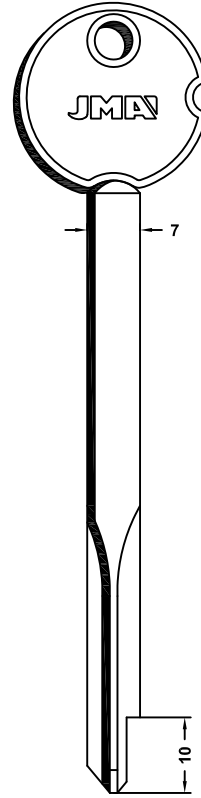

  
**ZE-9X**  
105mm



# **LLAVES DE GORJA ACERO DULCE**

*ALTZAIRU GOZOZKO GORJA-GILTZA  
MILD STEEL BIT KEYS  
CLES A GORGES EN ACIER DOUX  
CHUBBSCHLÜSSEL AUS WEICHSTAHL*

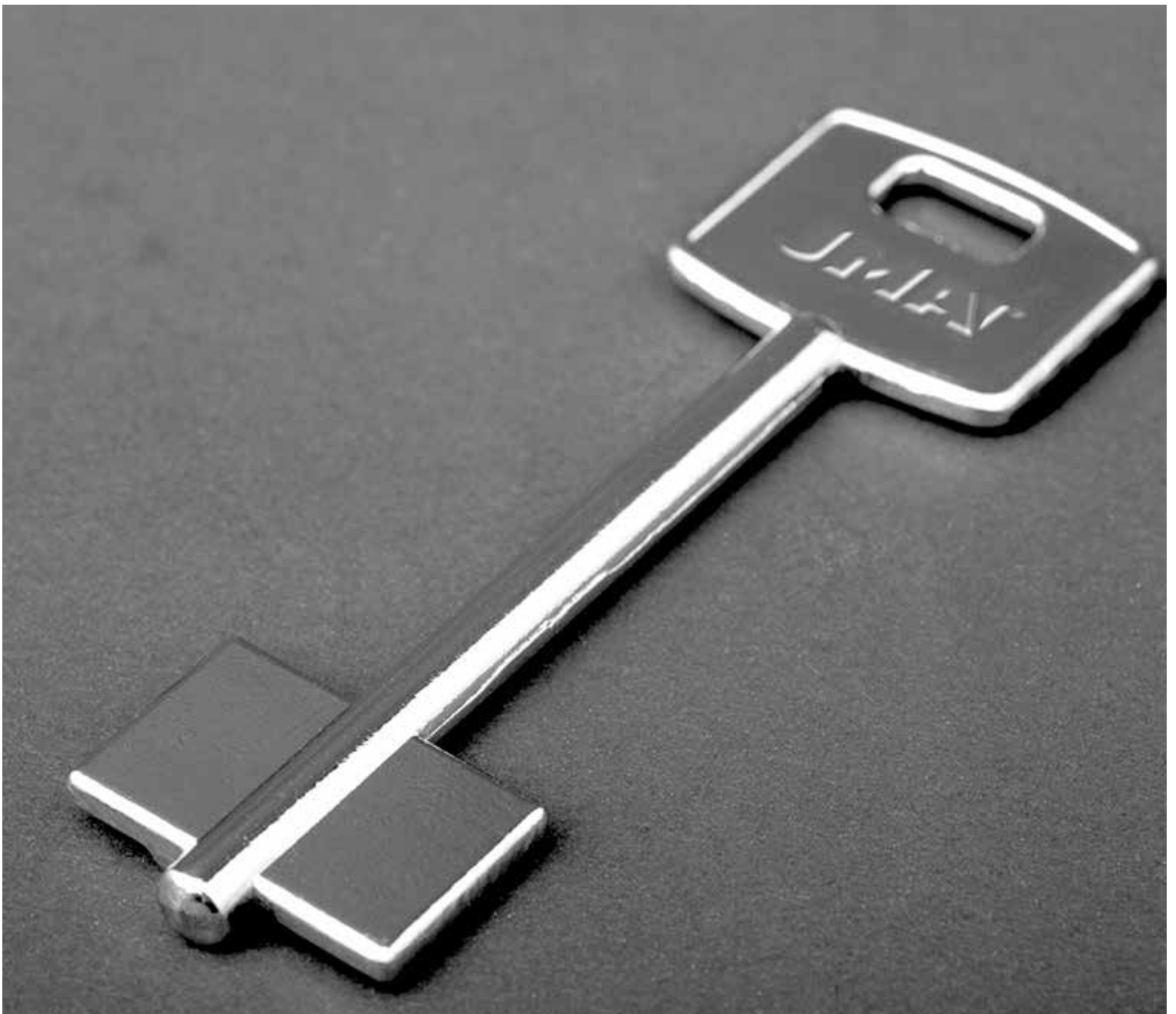

**THE KEY TO EXCELLENCE**  
GLOBALLY UNLOCKING MILLIONS OF DOORS DAILY

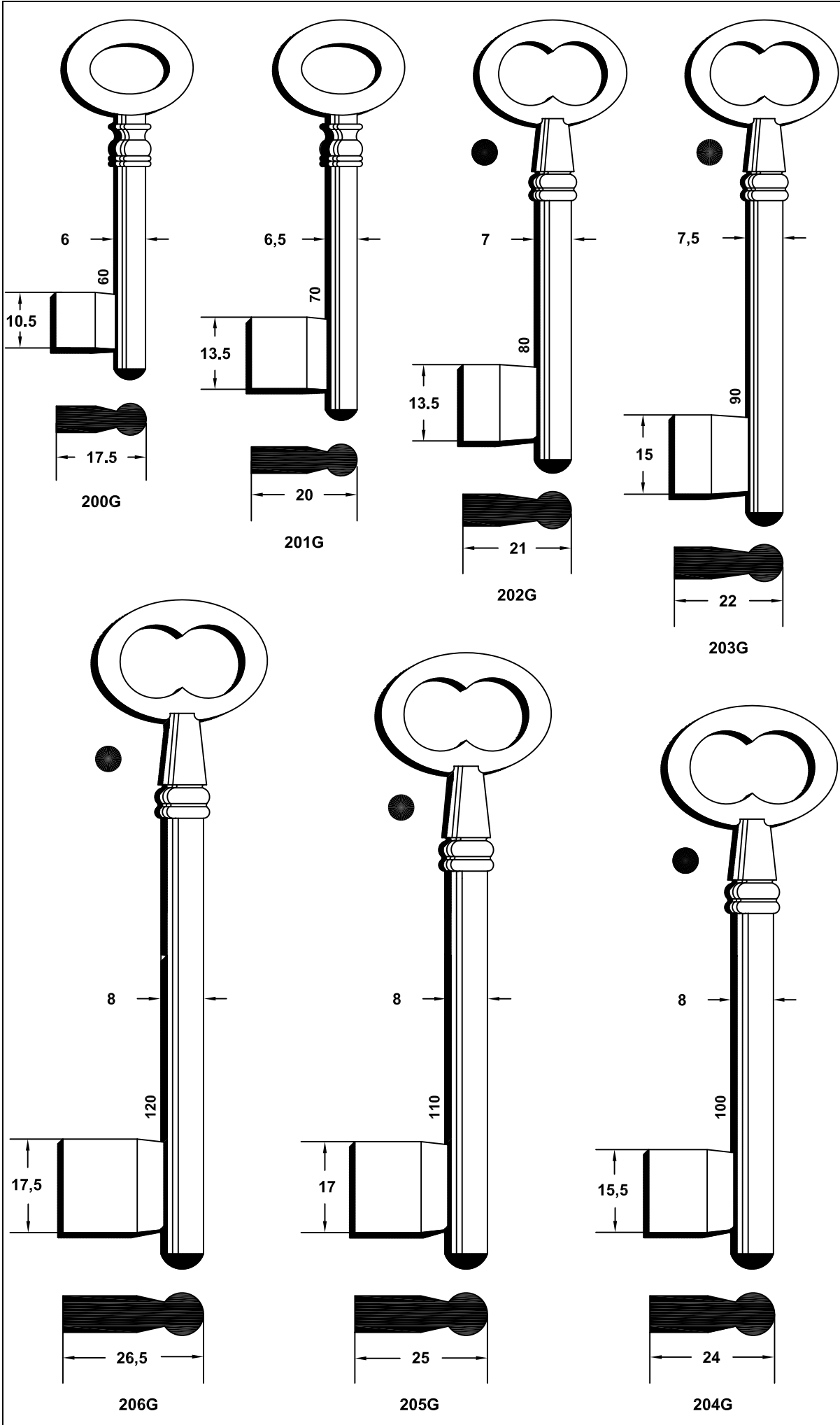

PARA-FOR:

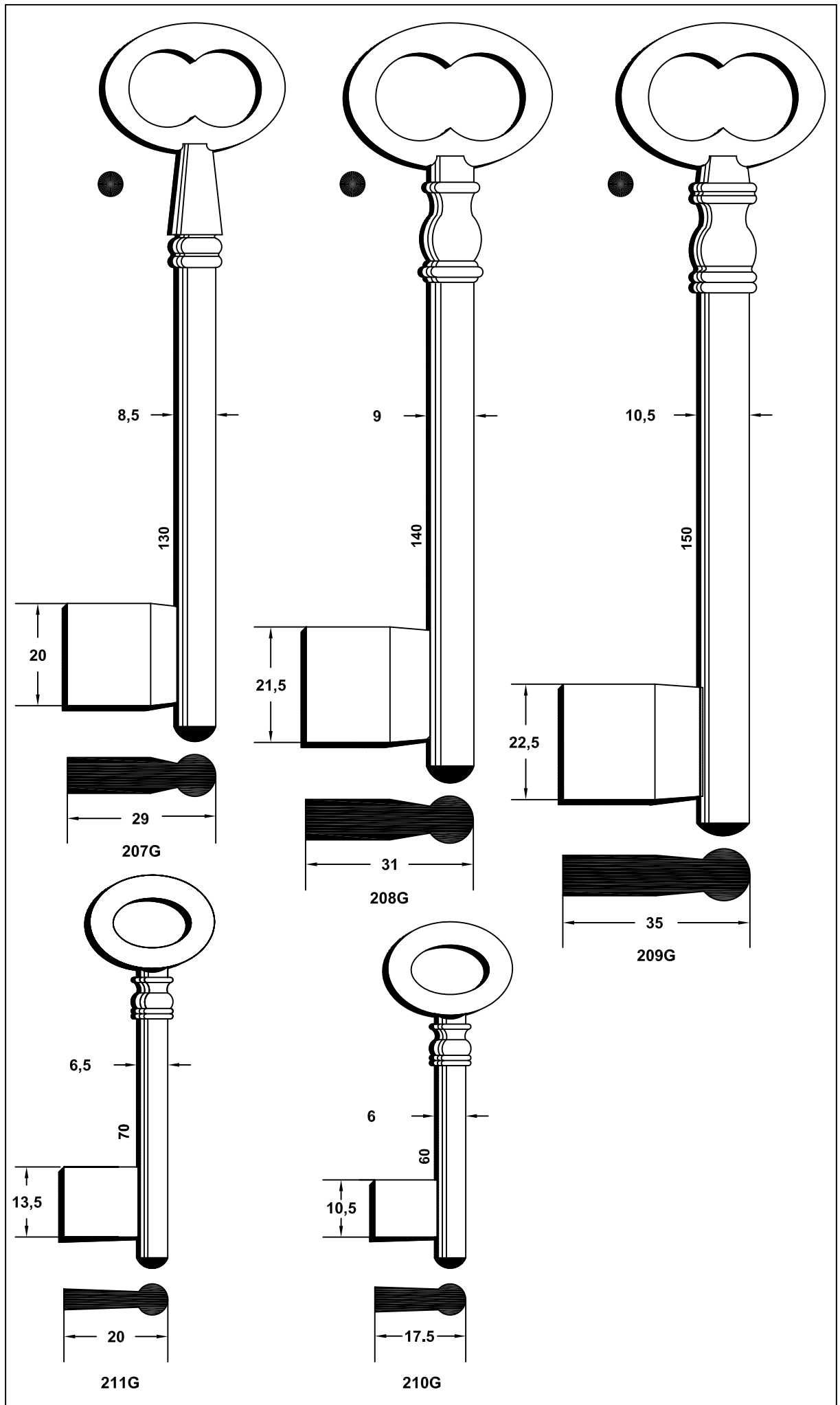

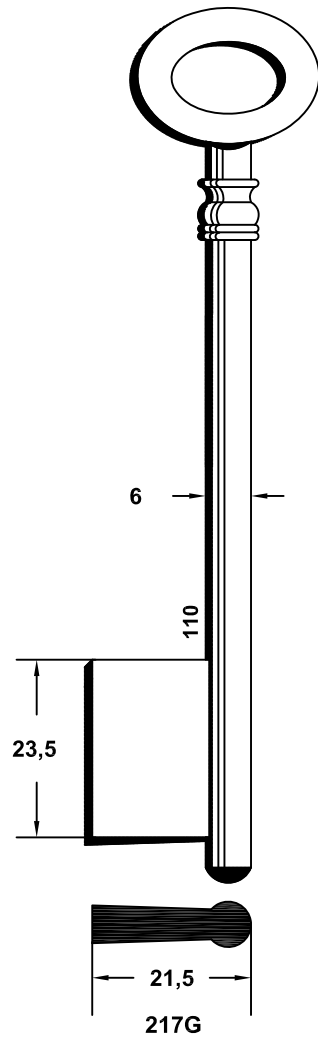
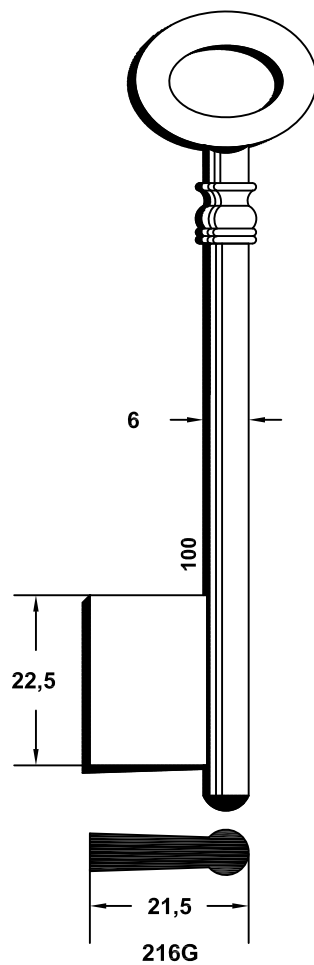
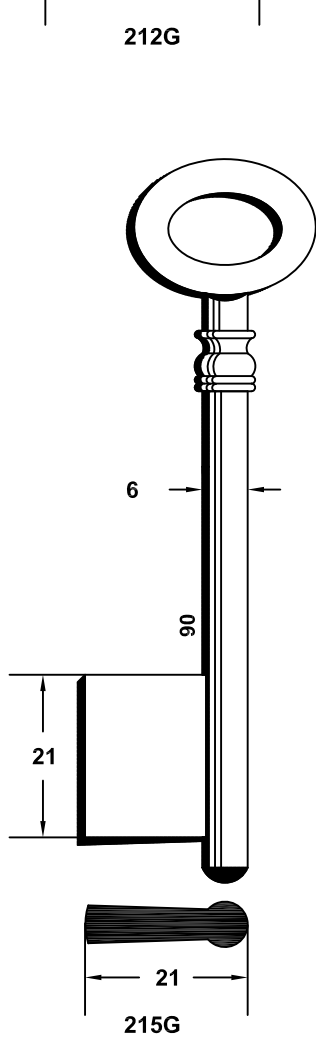
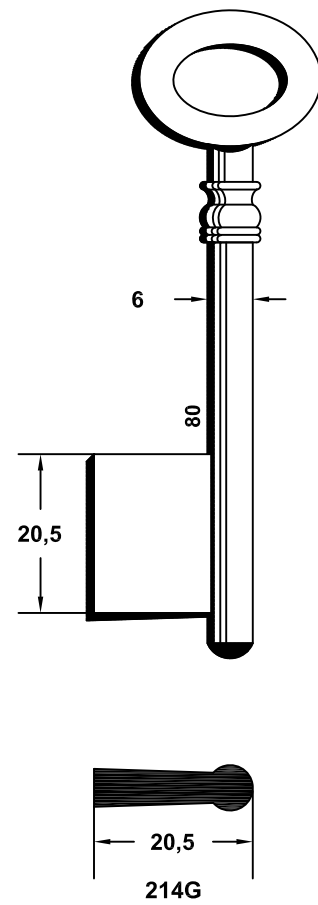
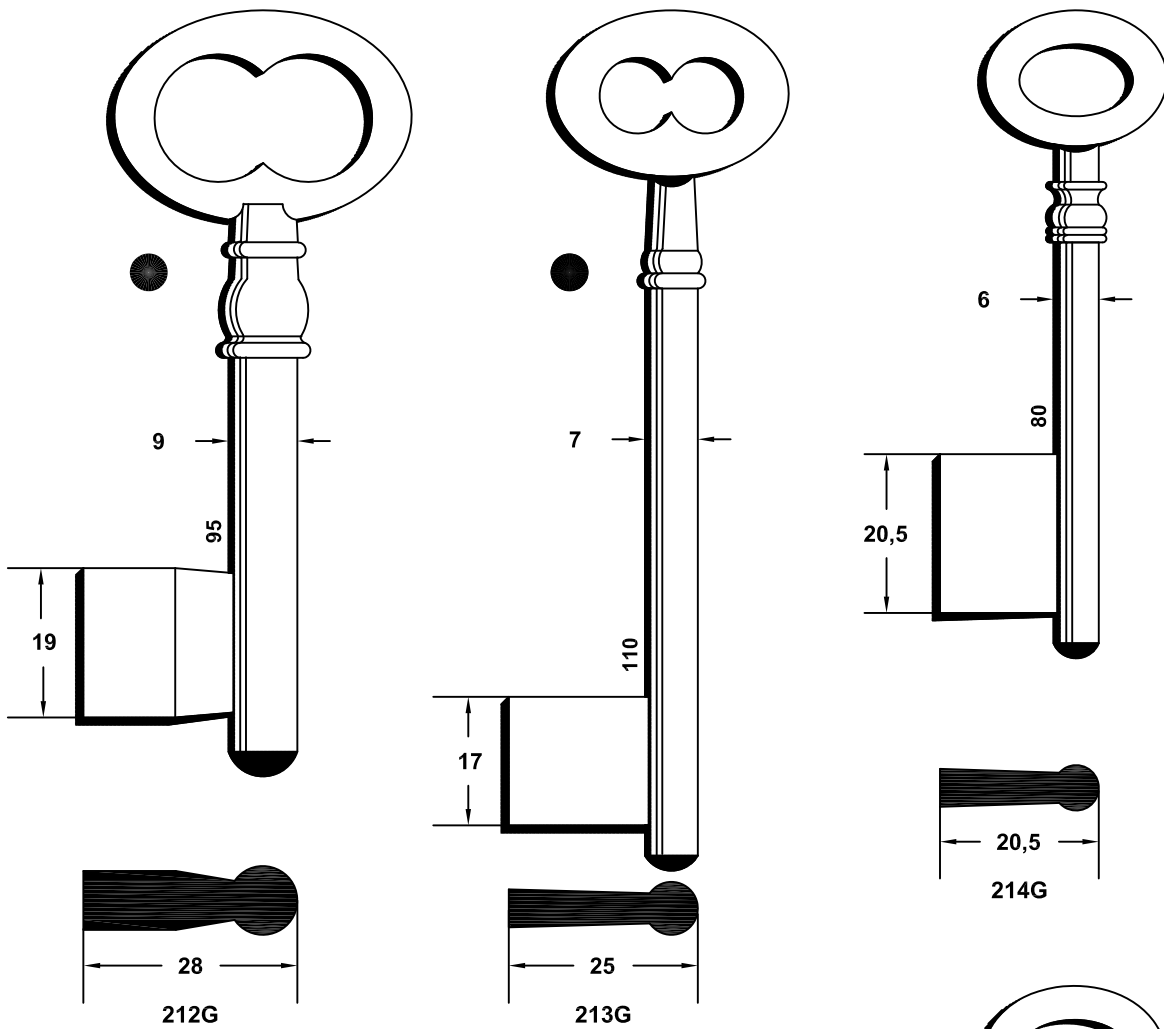

PARA-FOR:

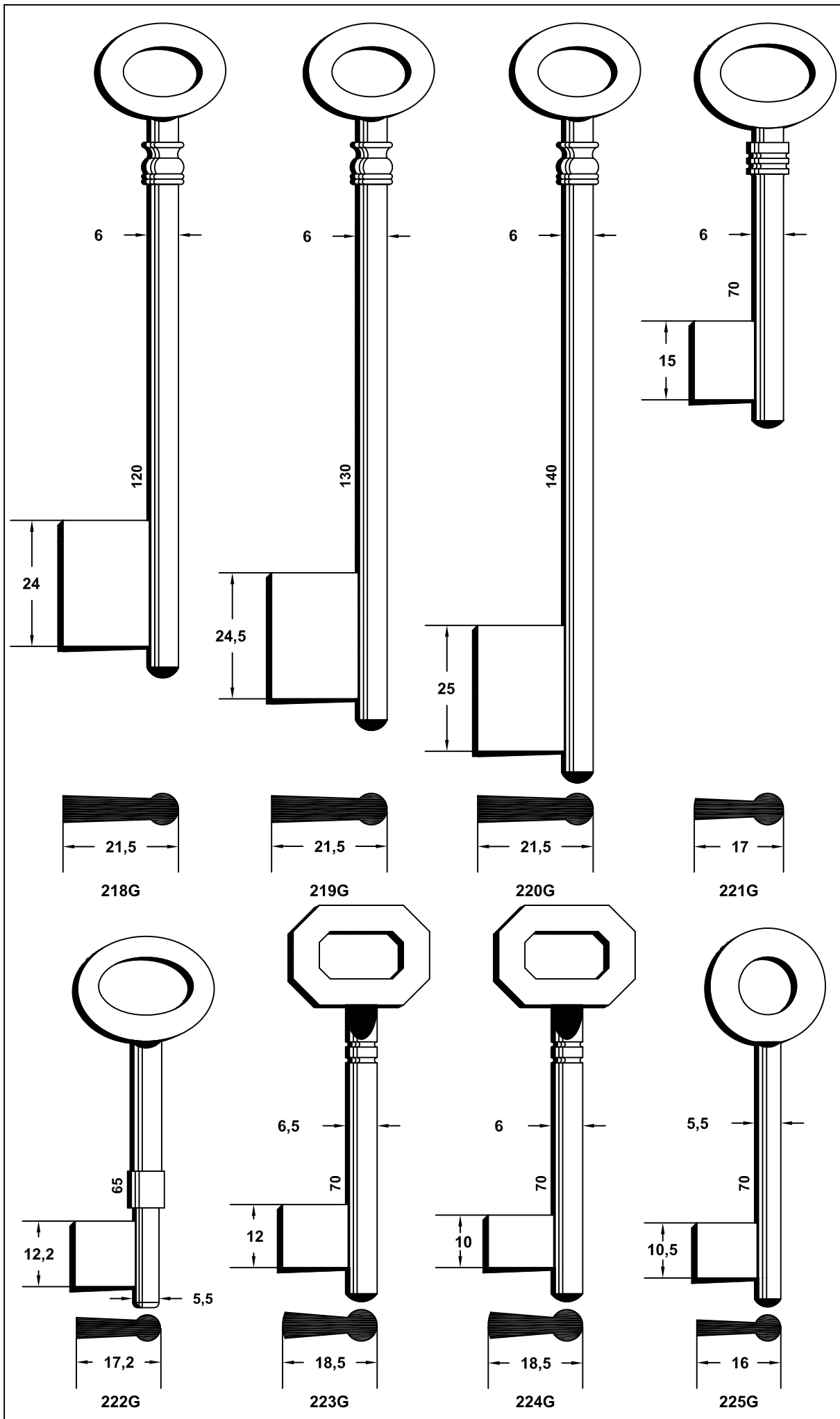



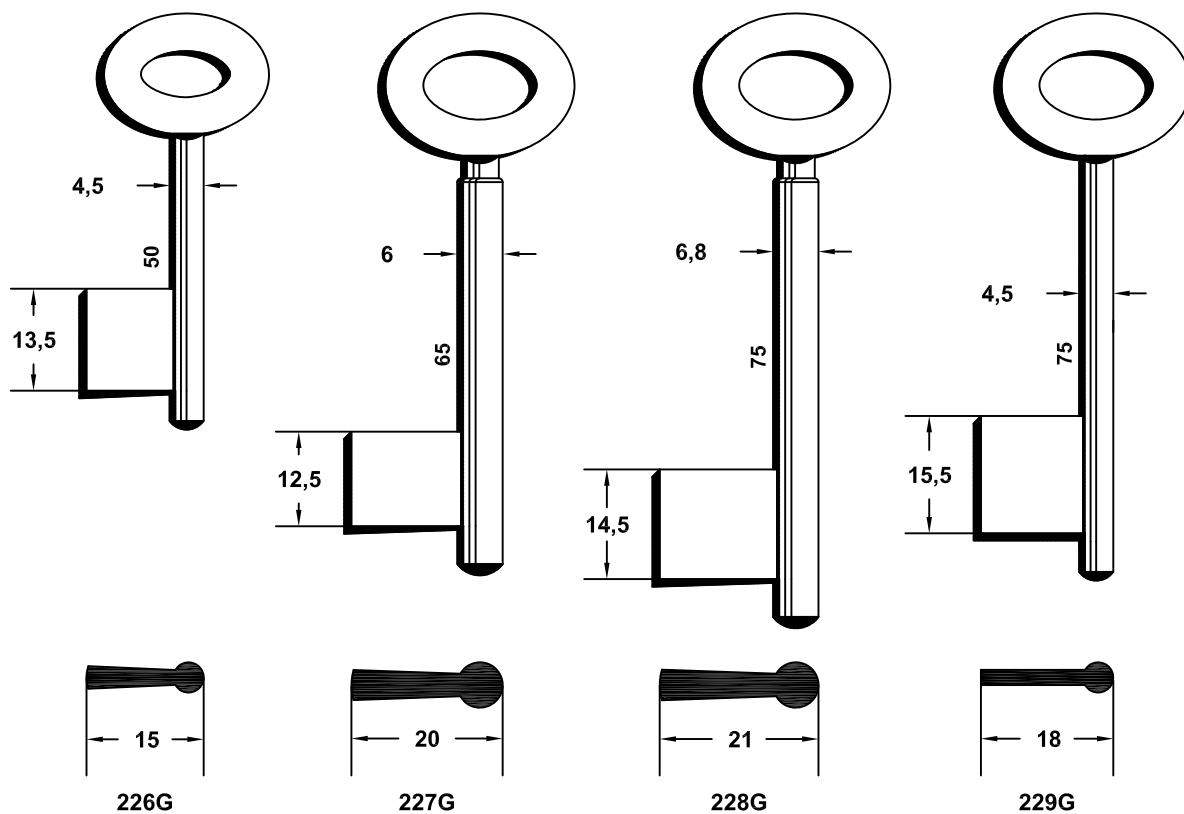

226G

227G

228G

229G

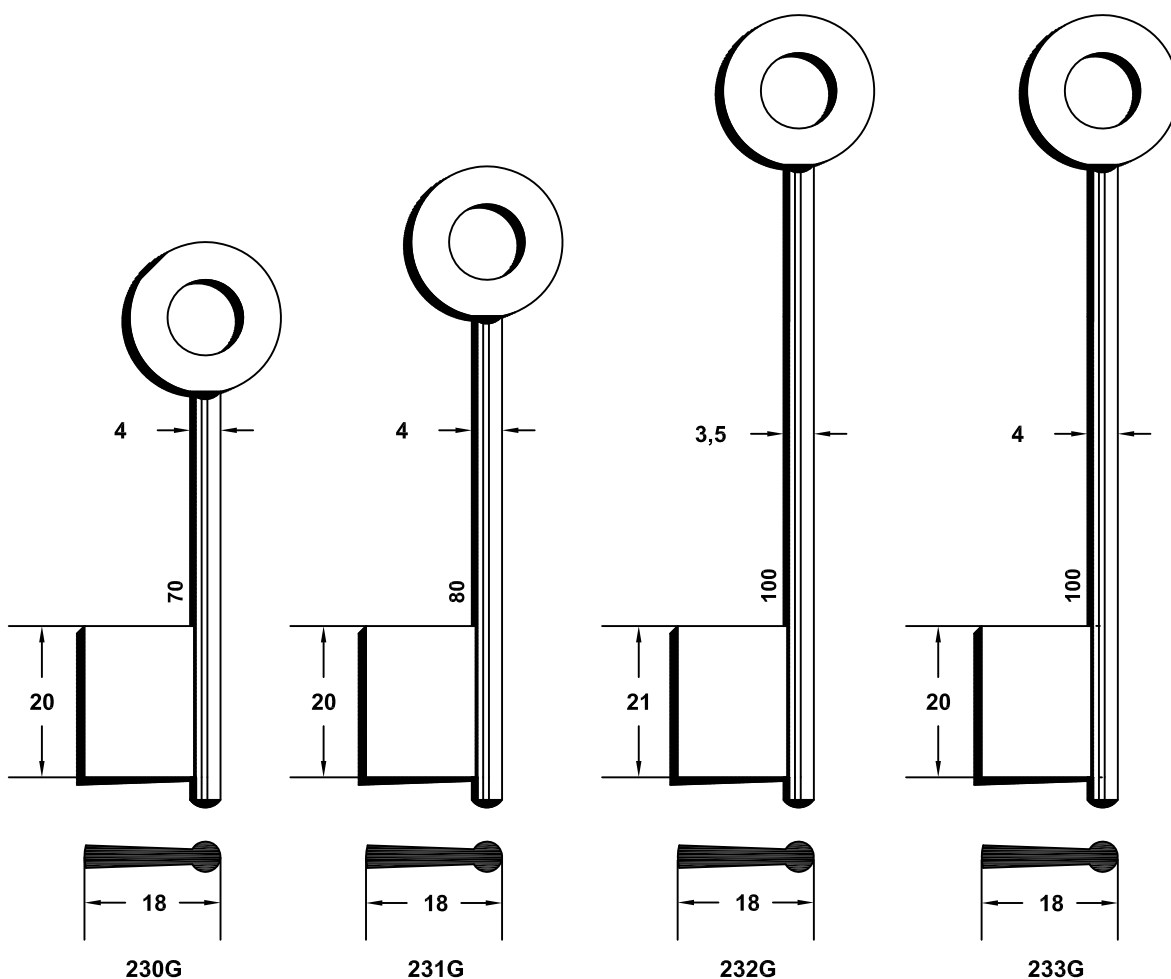

230G

231G

232G

233G



**PARA-FOR:**  
BOINAITI (I)

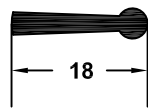
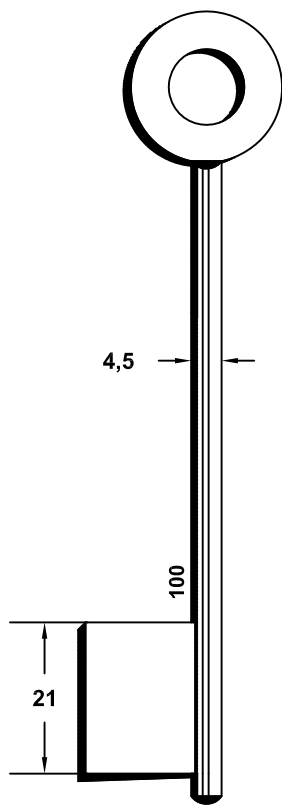

234G

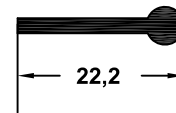
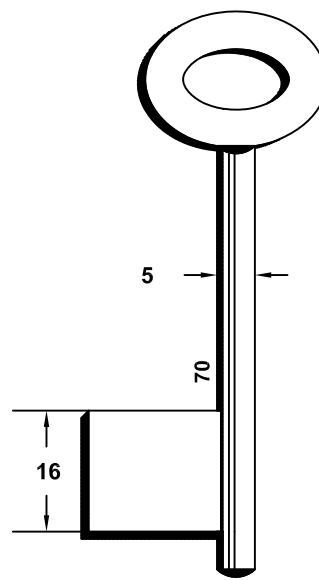

236G

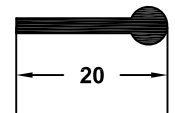
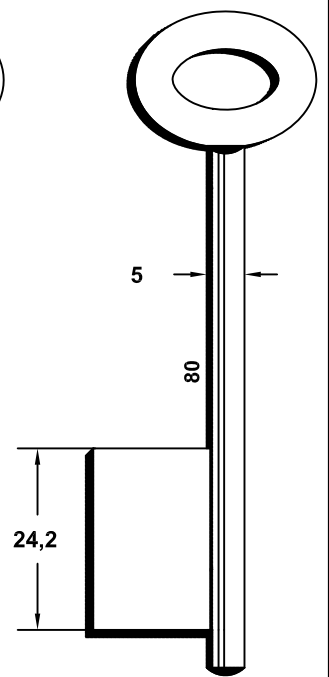

237G

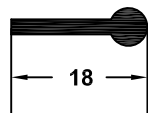
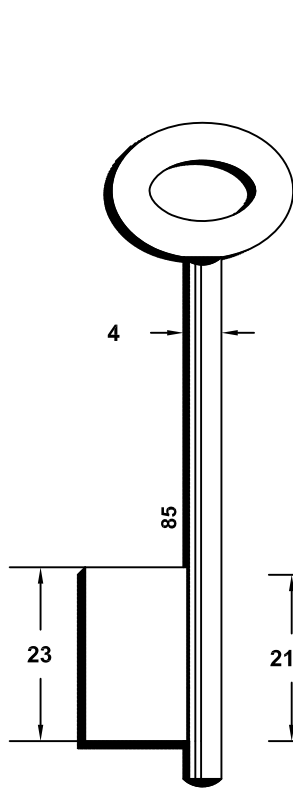

238G

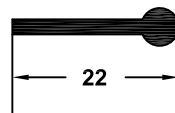
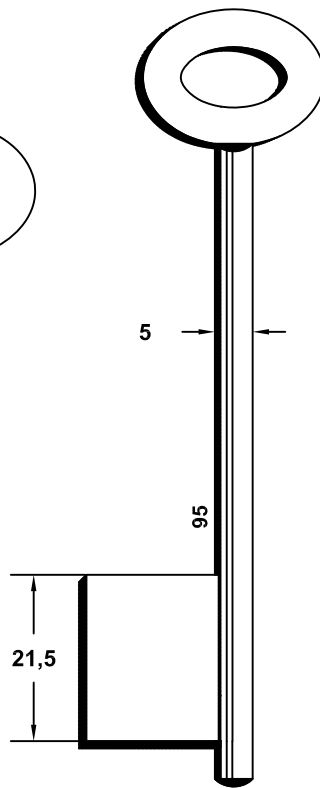

239G

**BOINAITI**

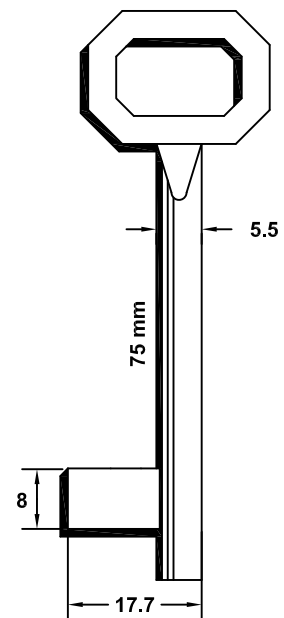

BON-3G



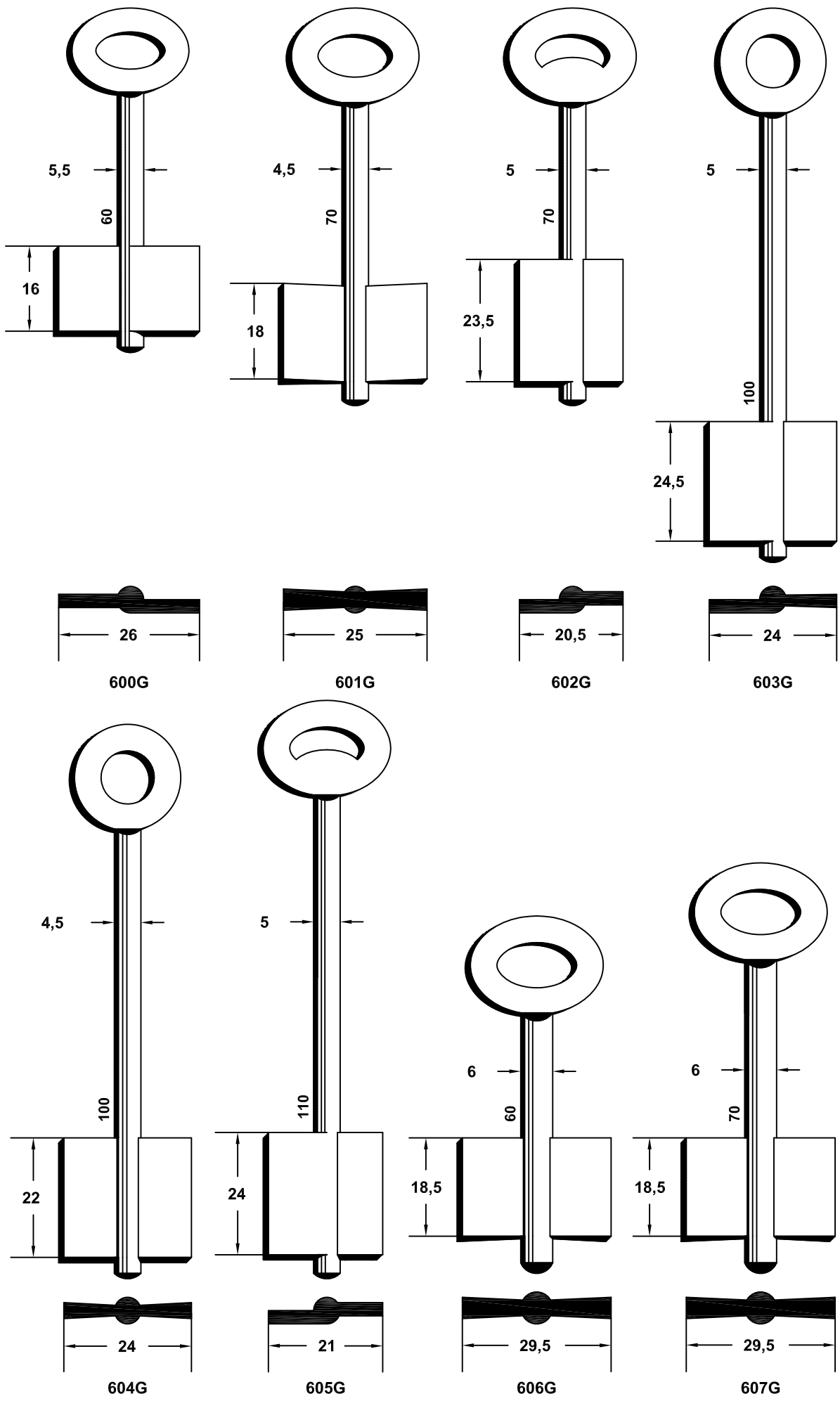

PARA-FOR:

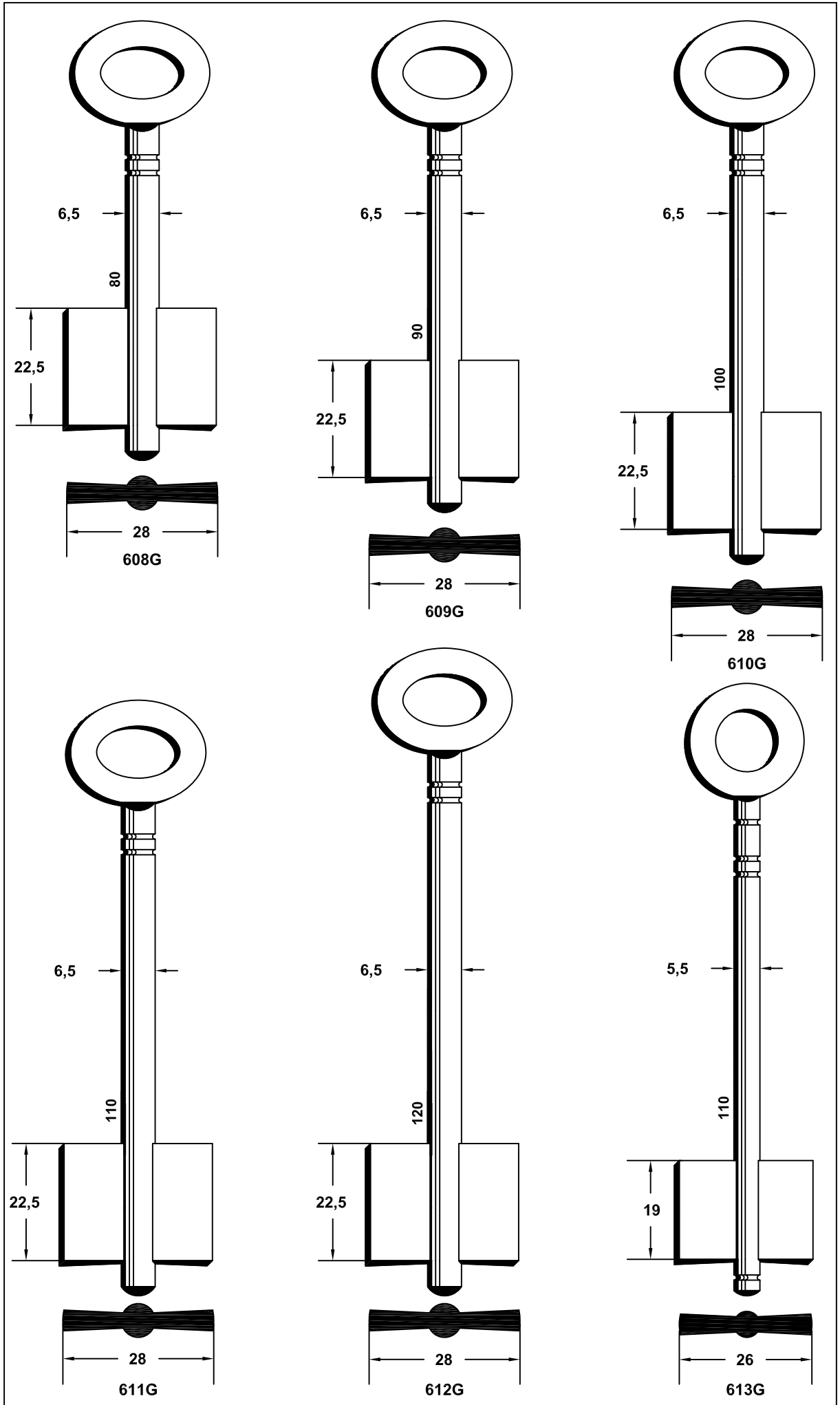

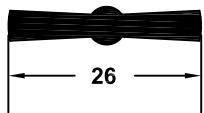
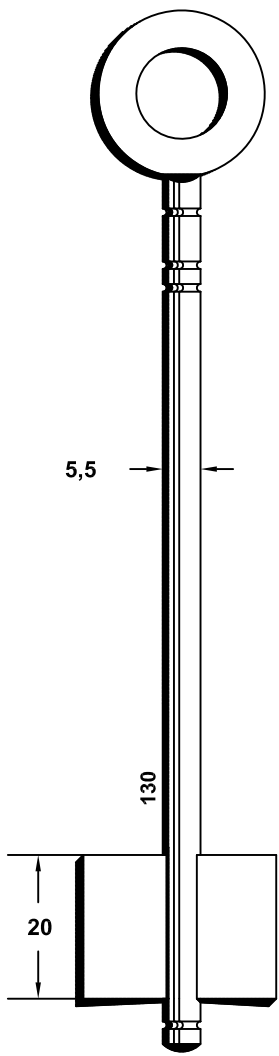

614G

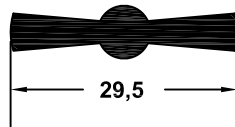
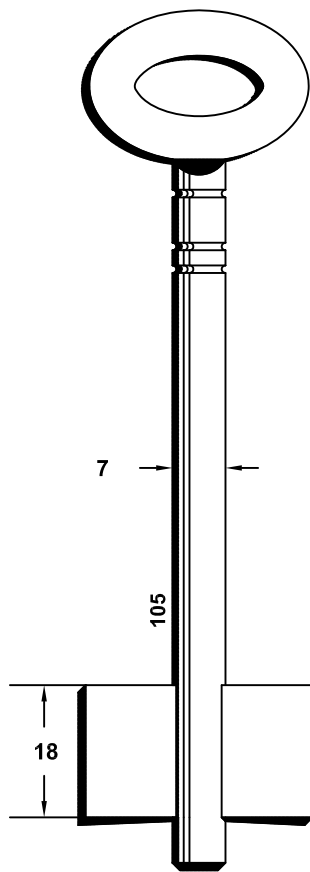

615G

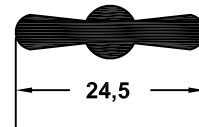
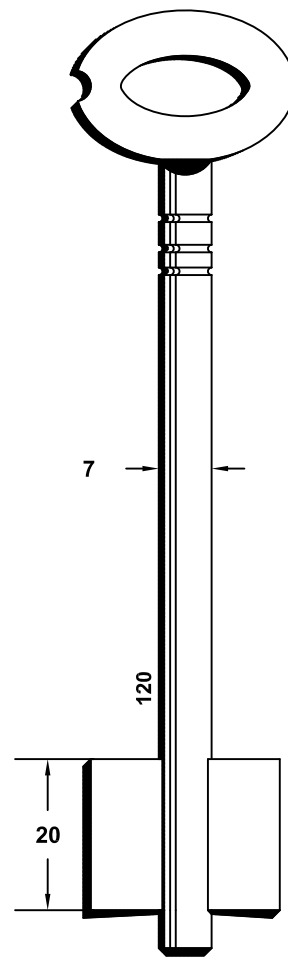

616G

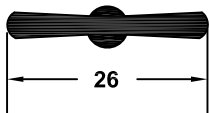
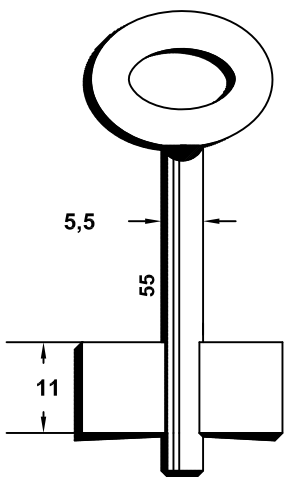

618G

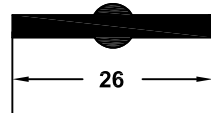
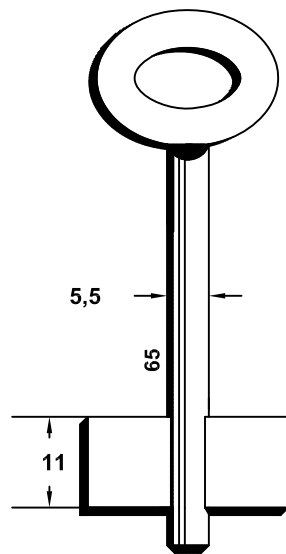

619G

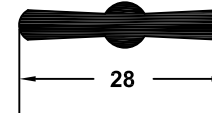
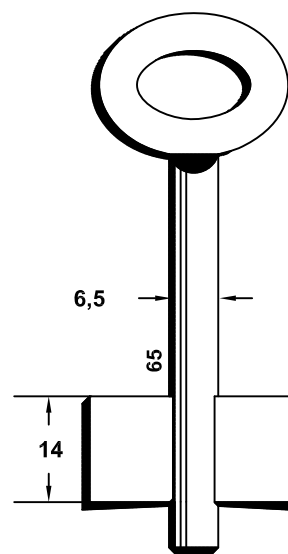

620G



PARA-FOR:

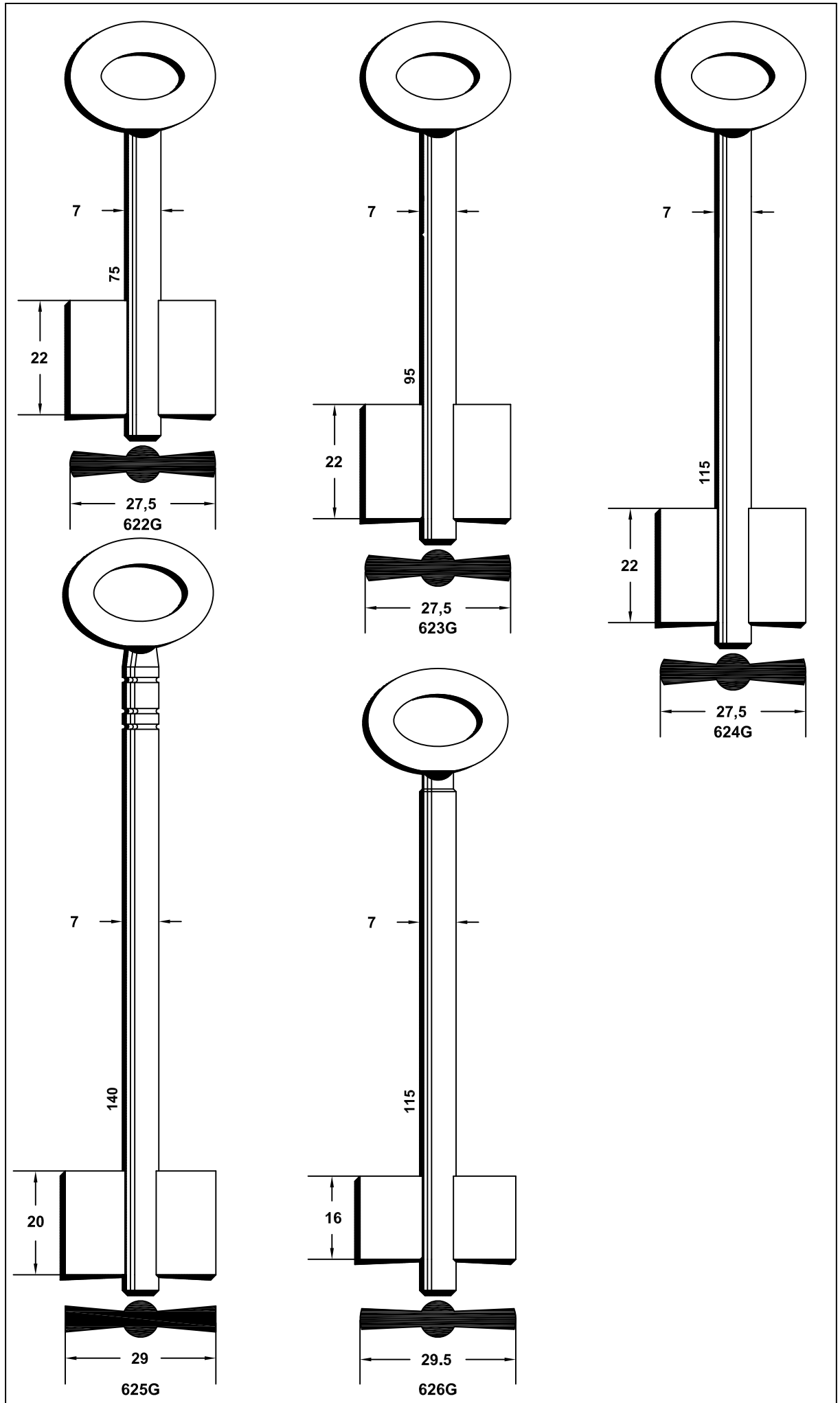

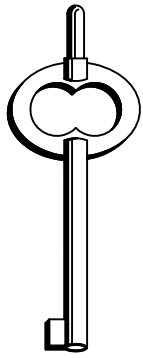

74G

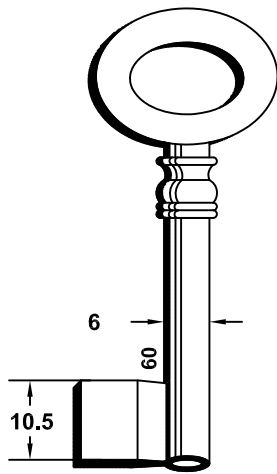

1200G

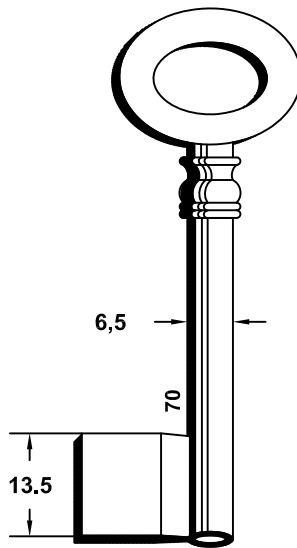

1201G

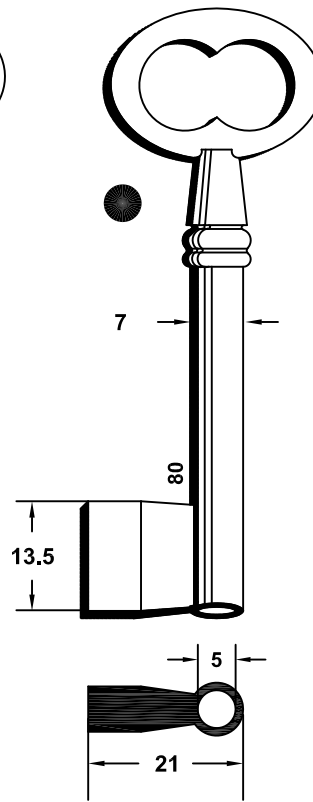

1202G

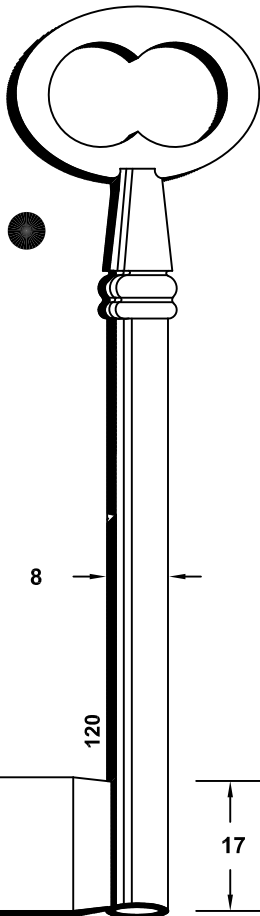

1206G

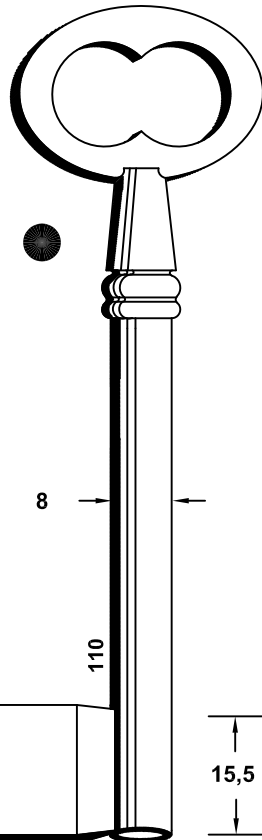

1205G

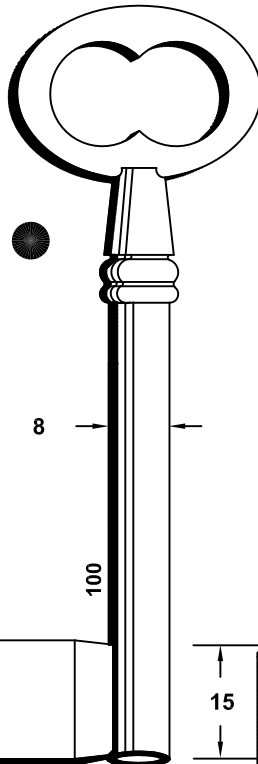

1204G

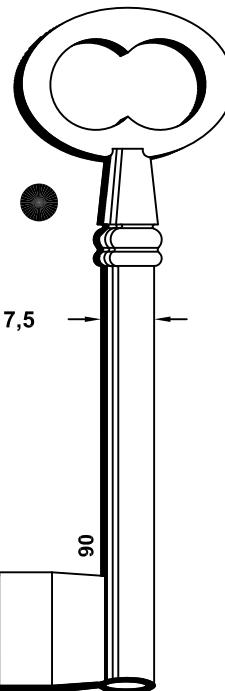

1203G

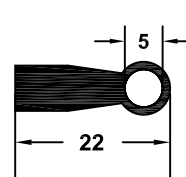
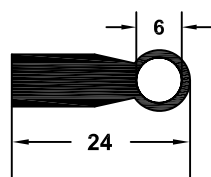
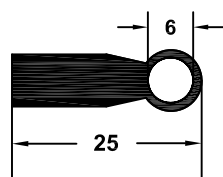
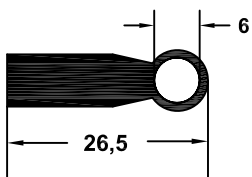



PARA-FOR:

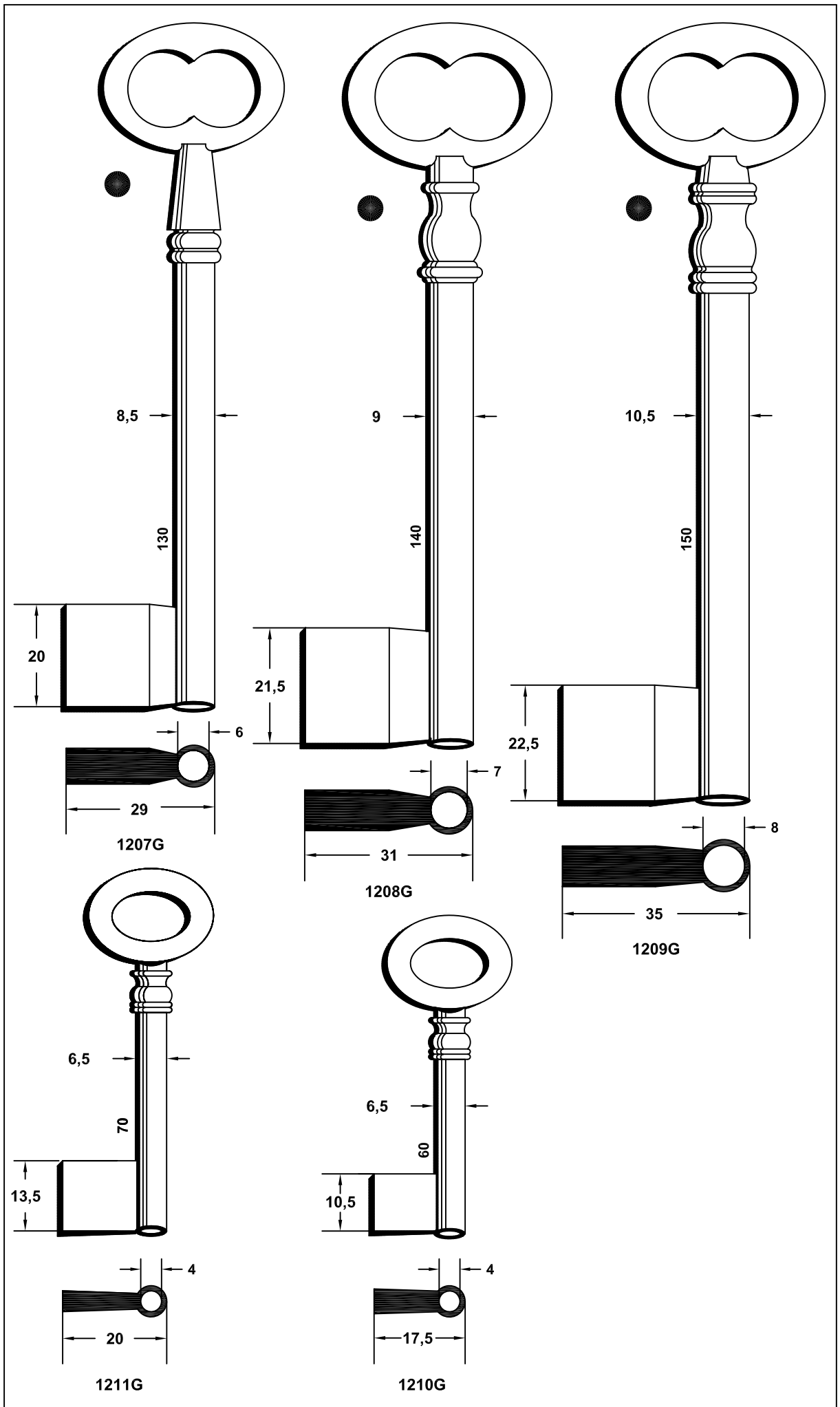

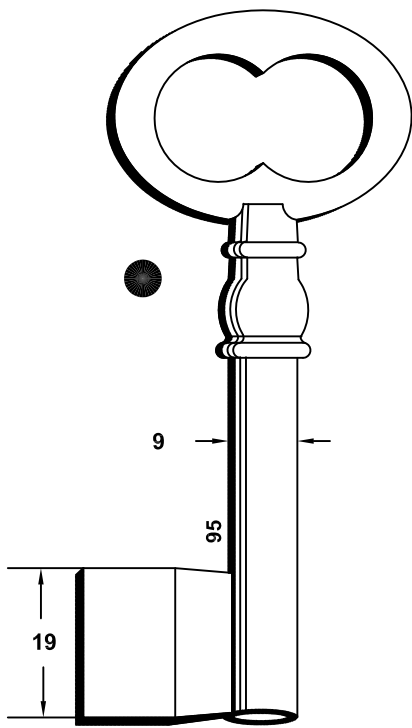

1212G

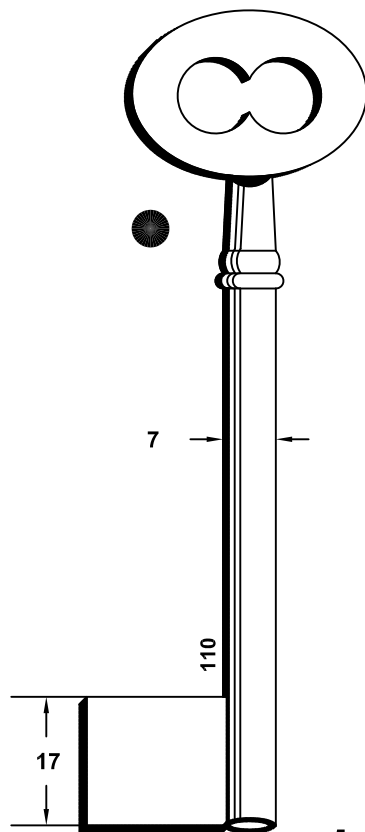

1213G

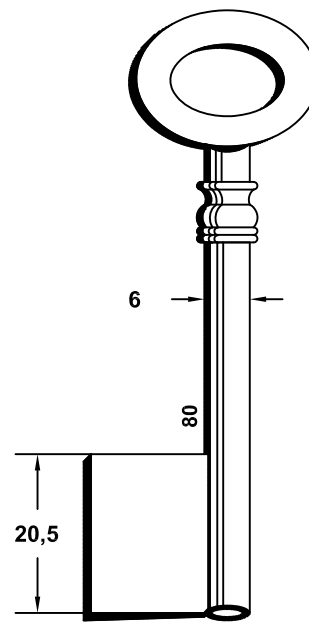

1214G

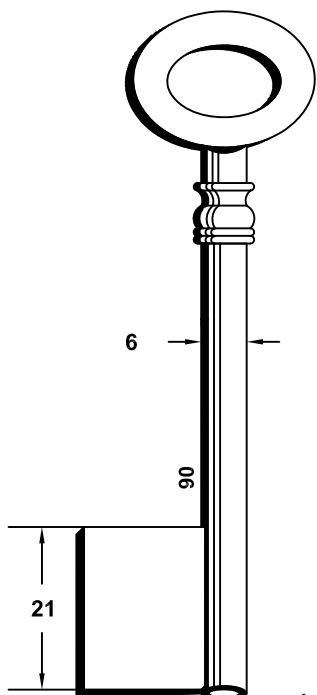

1215G

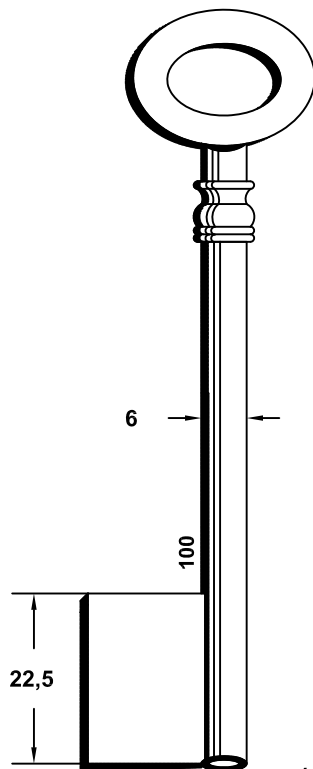

1216G

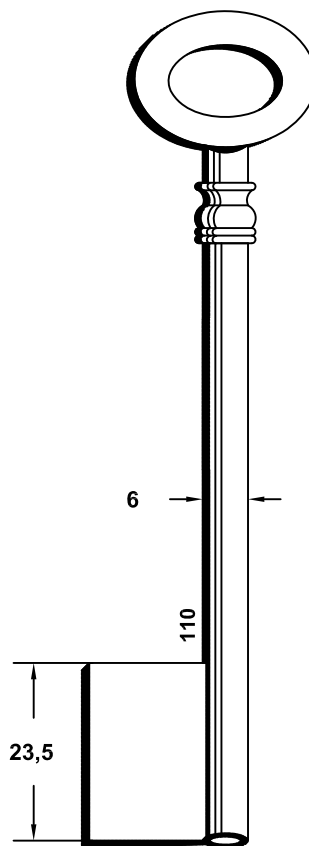

1217G



PARA-FOR:

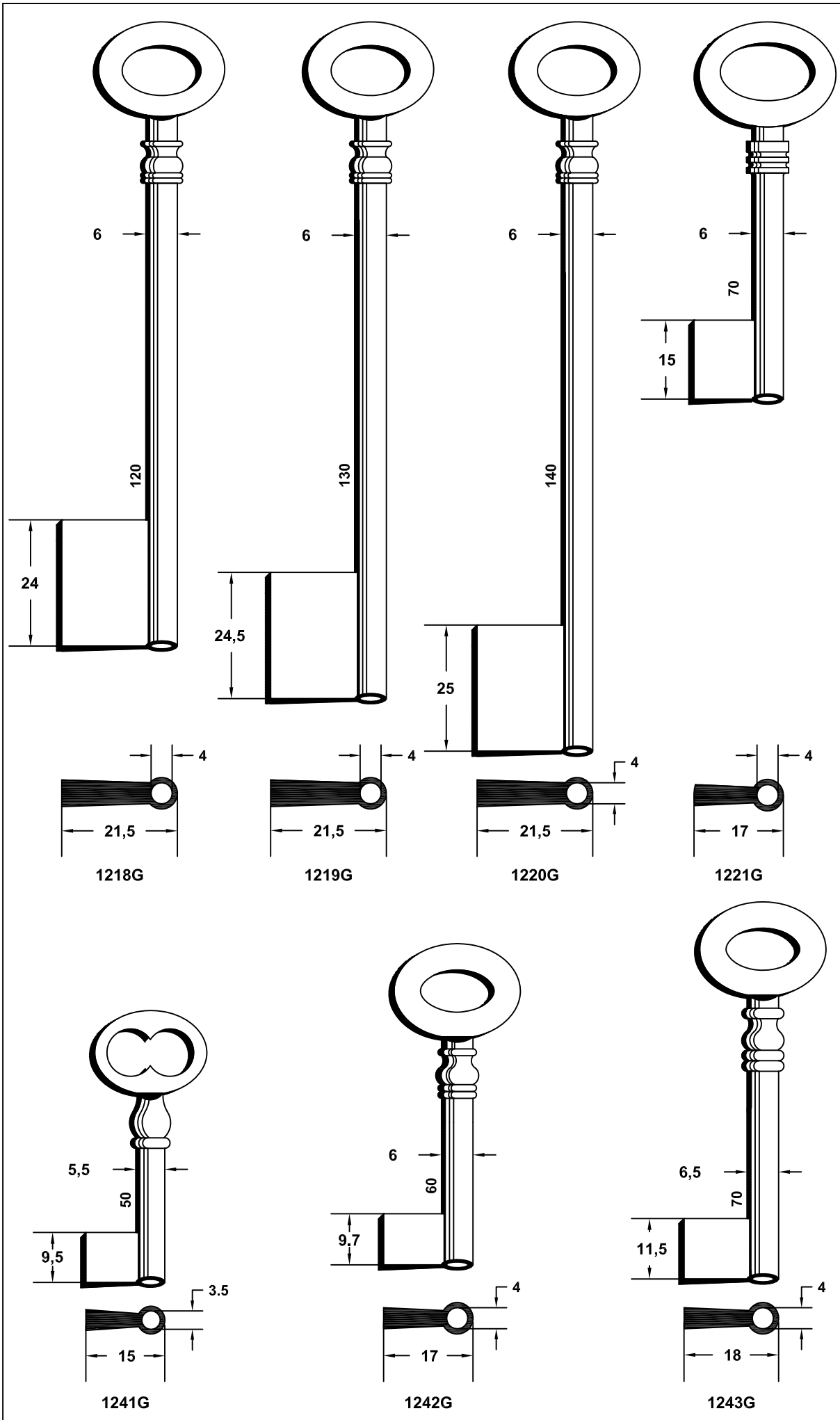

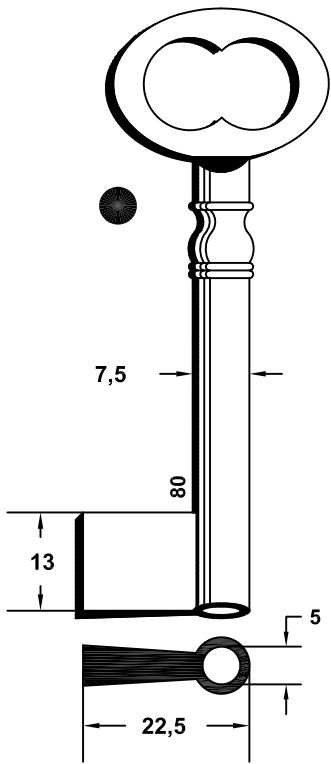

1244G

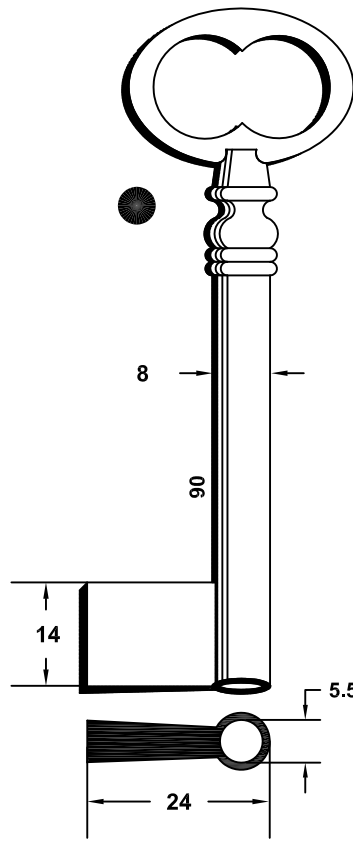

1245G

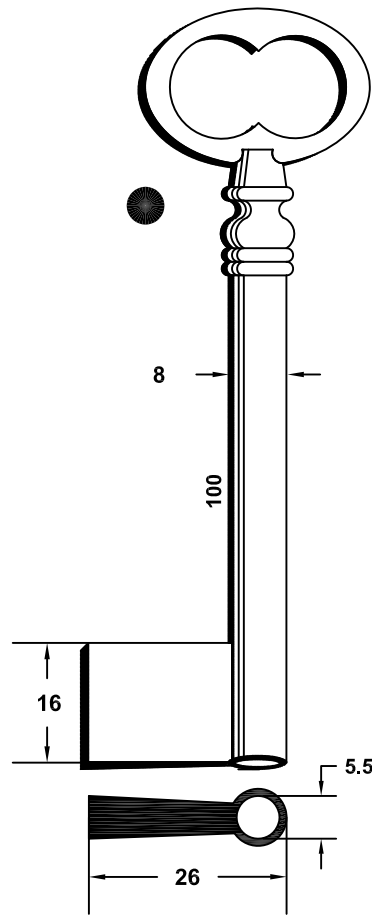

1246G

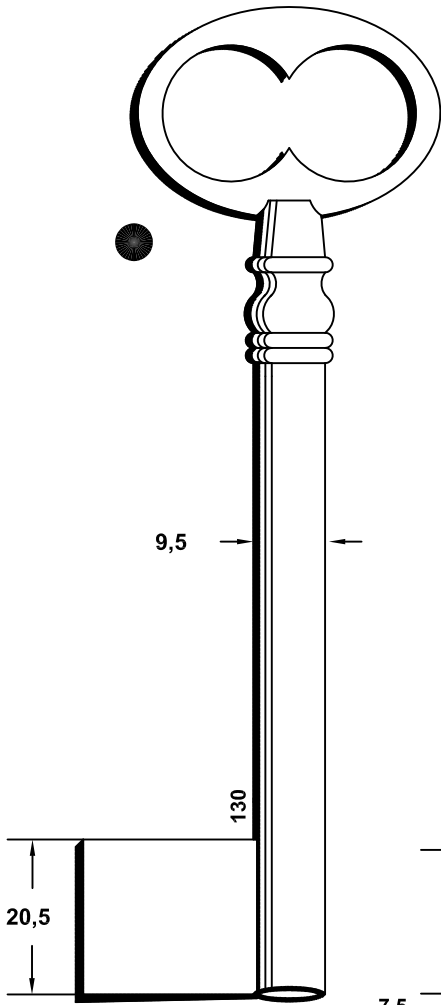

1249G

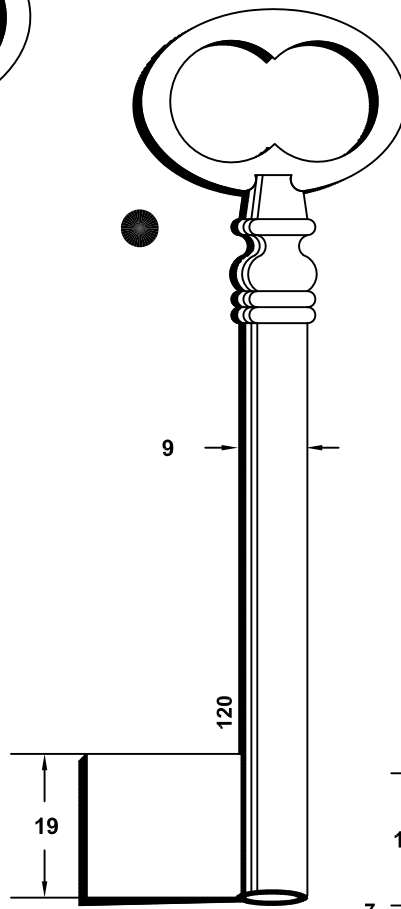

1248G

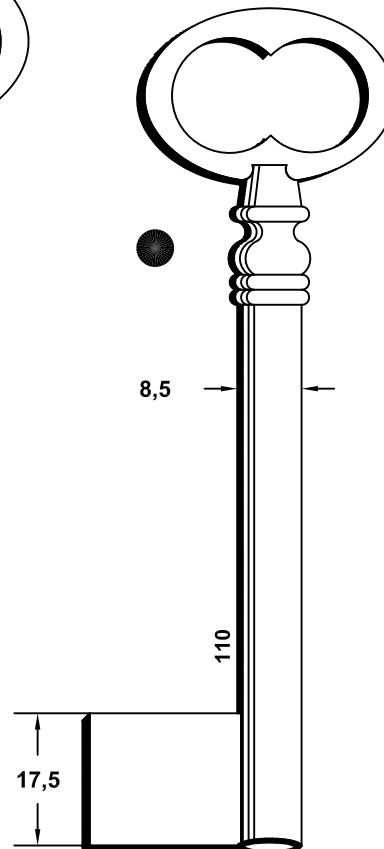

1247G



PARA-FOR:

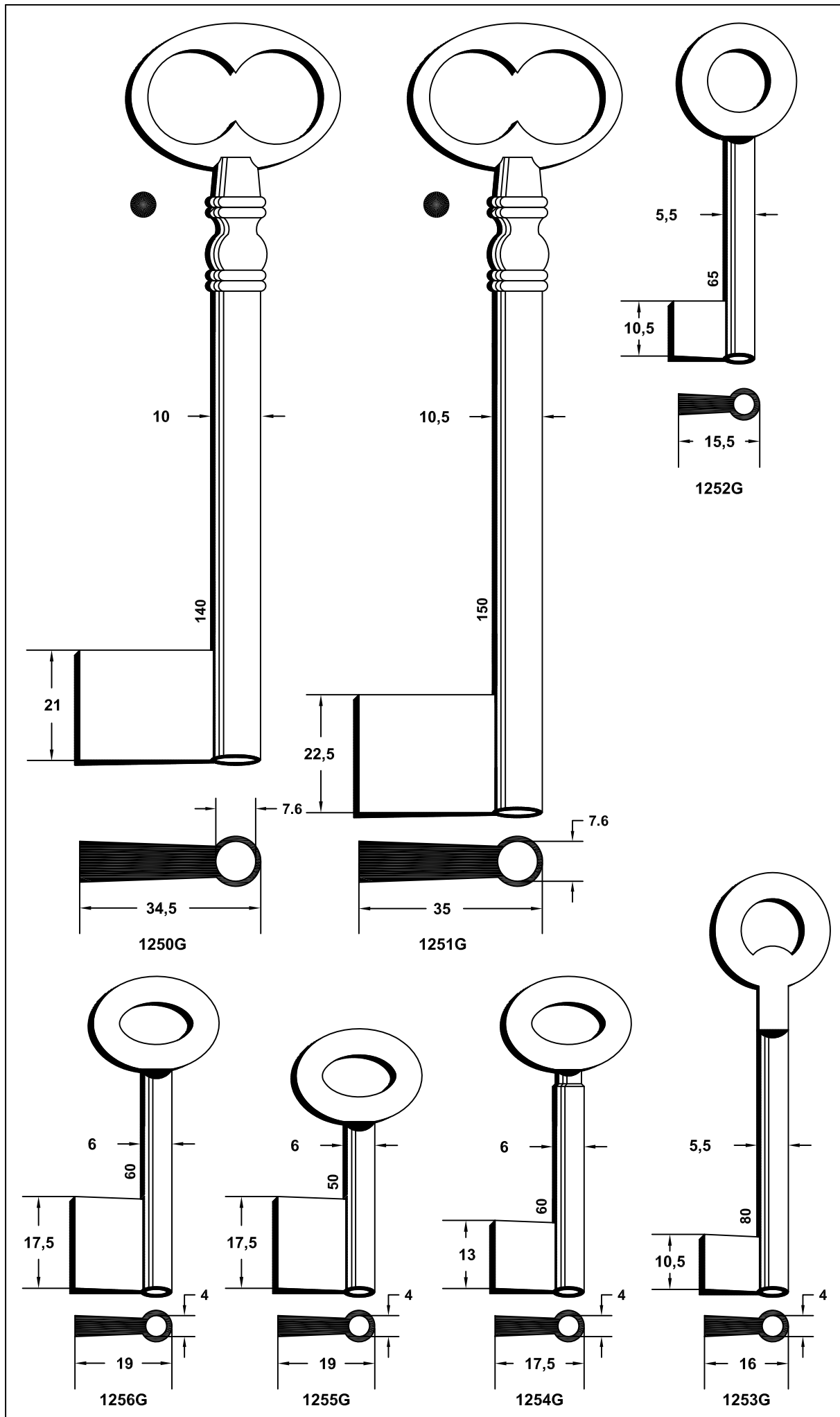

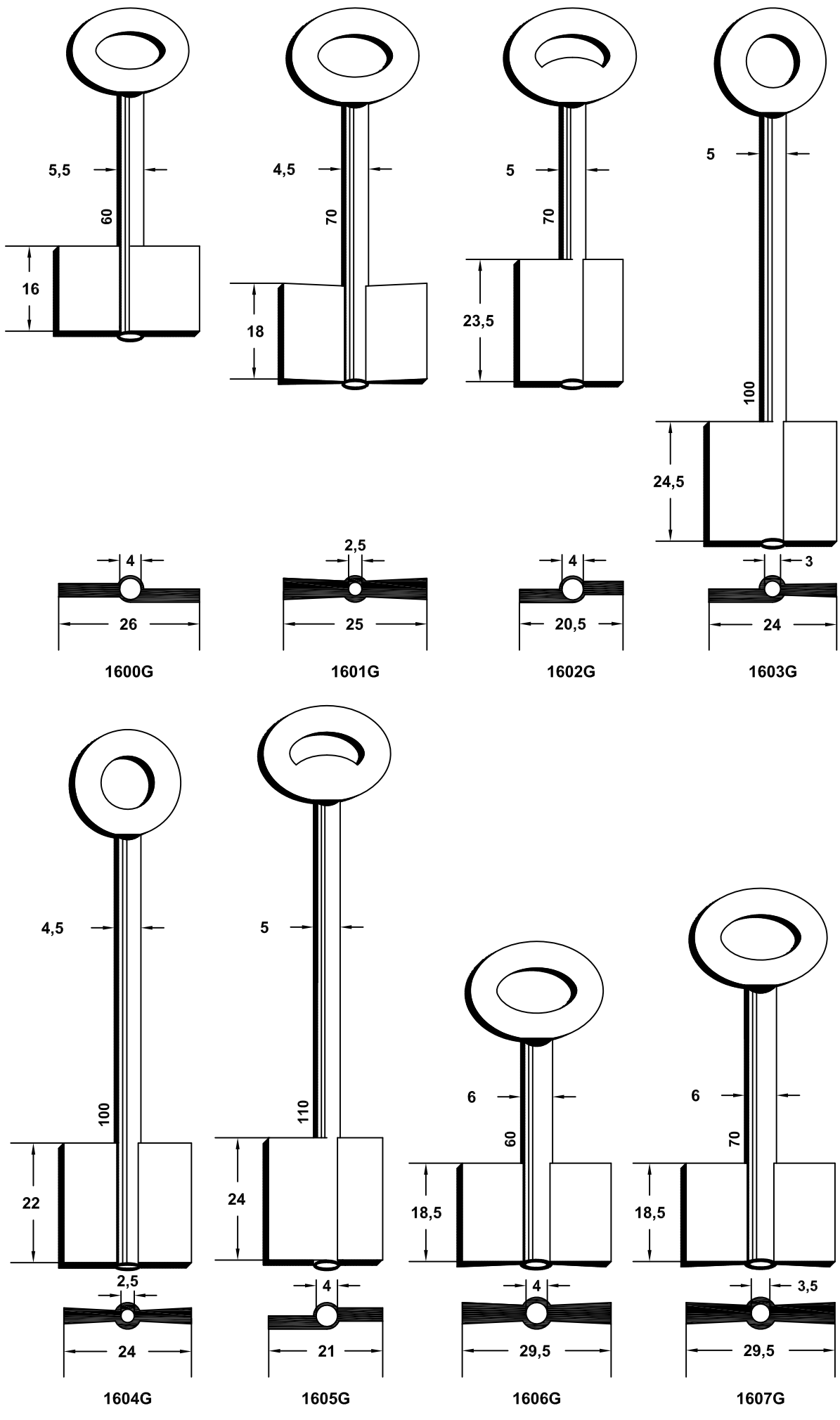

PARA-FOR:

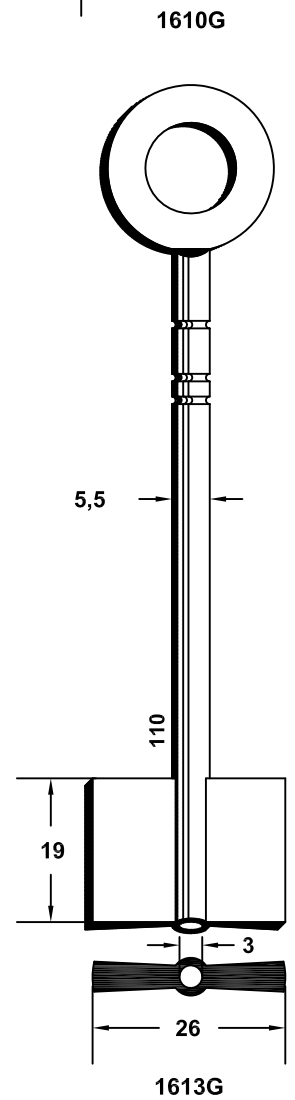
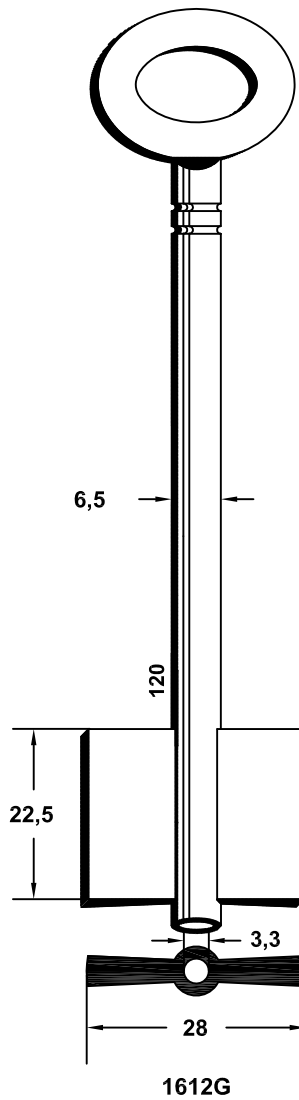
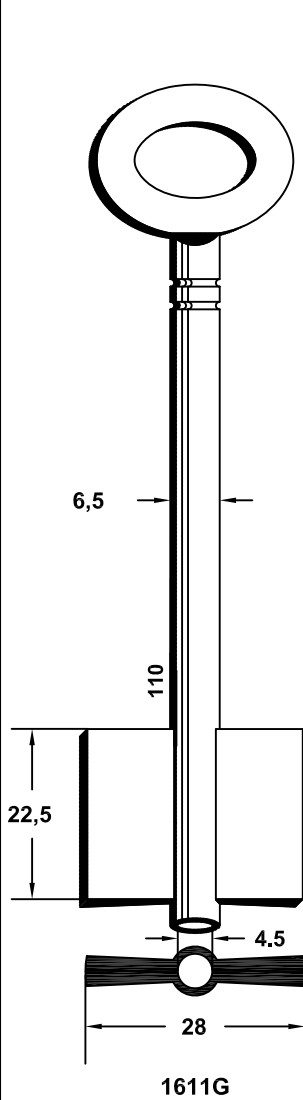
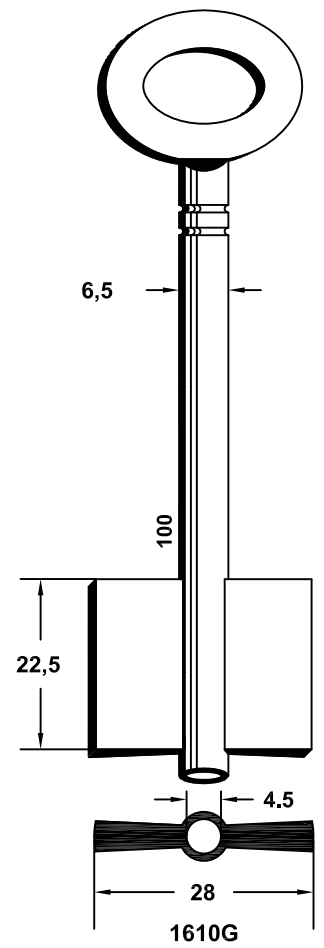
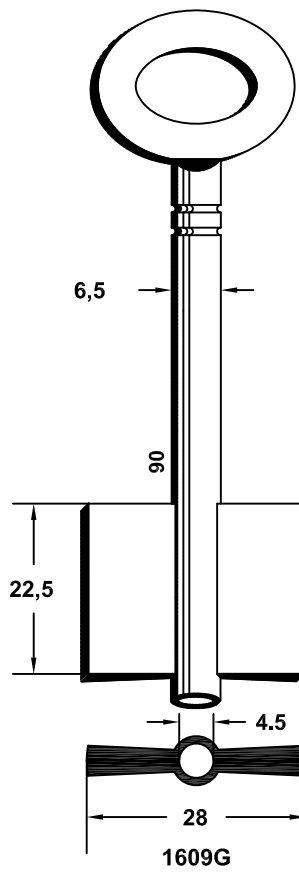
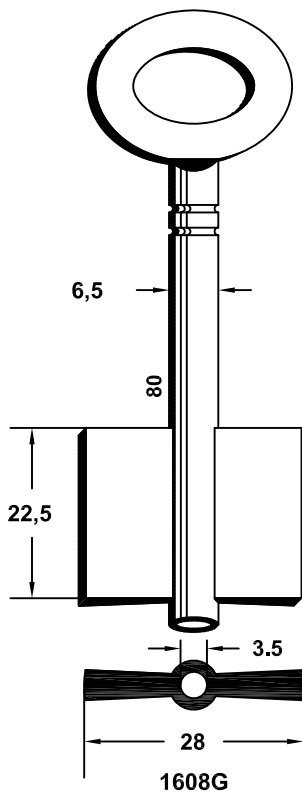



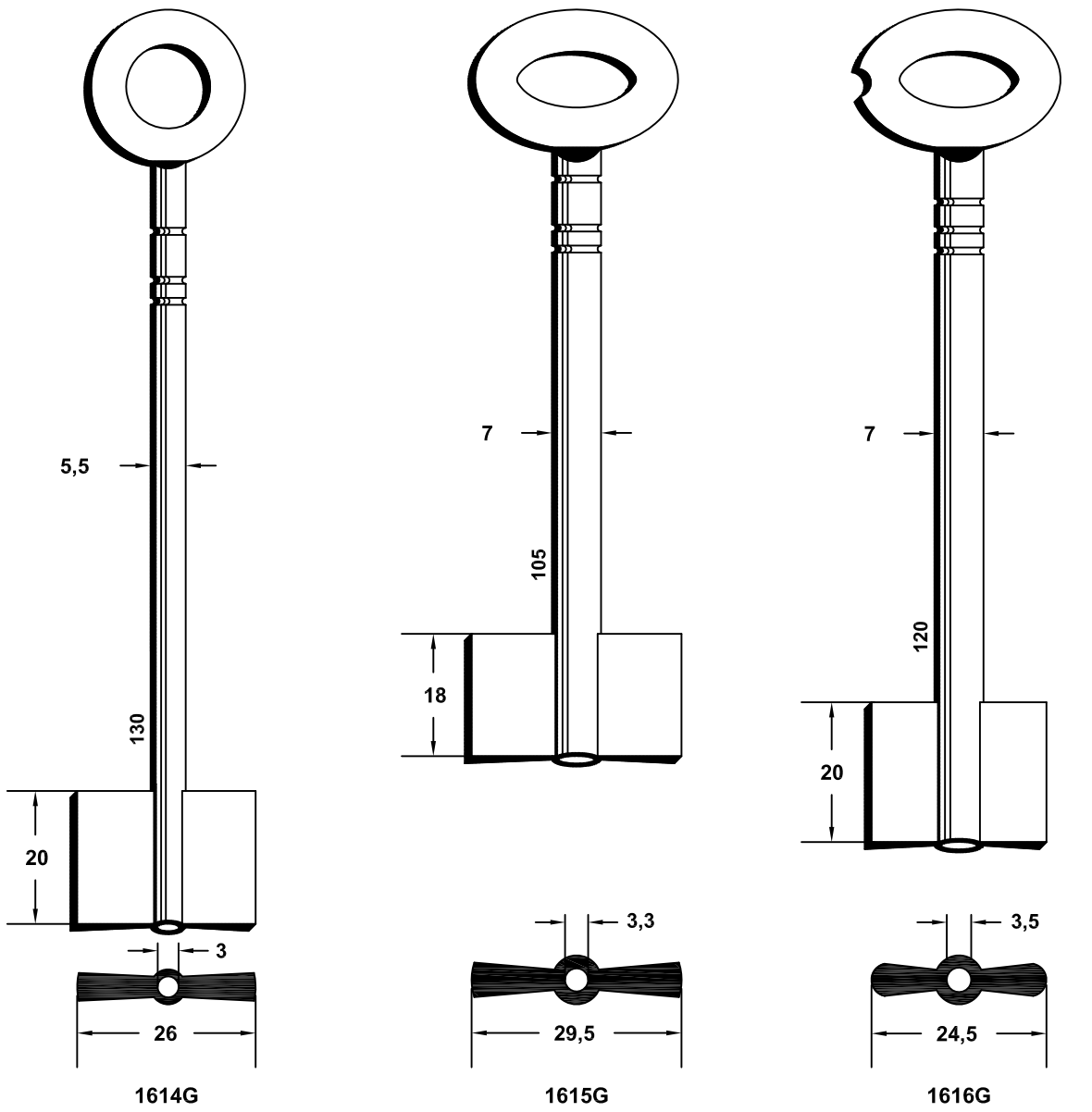

1614G

1615G

1616G

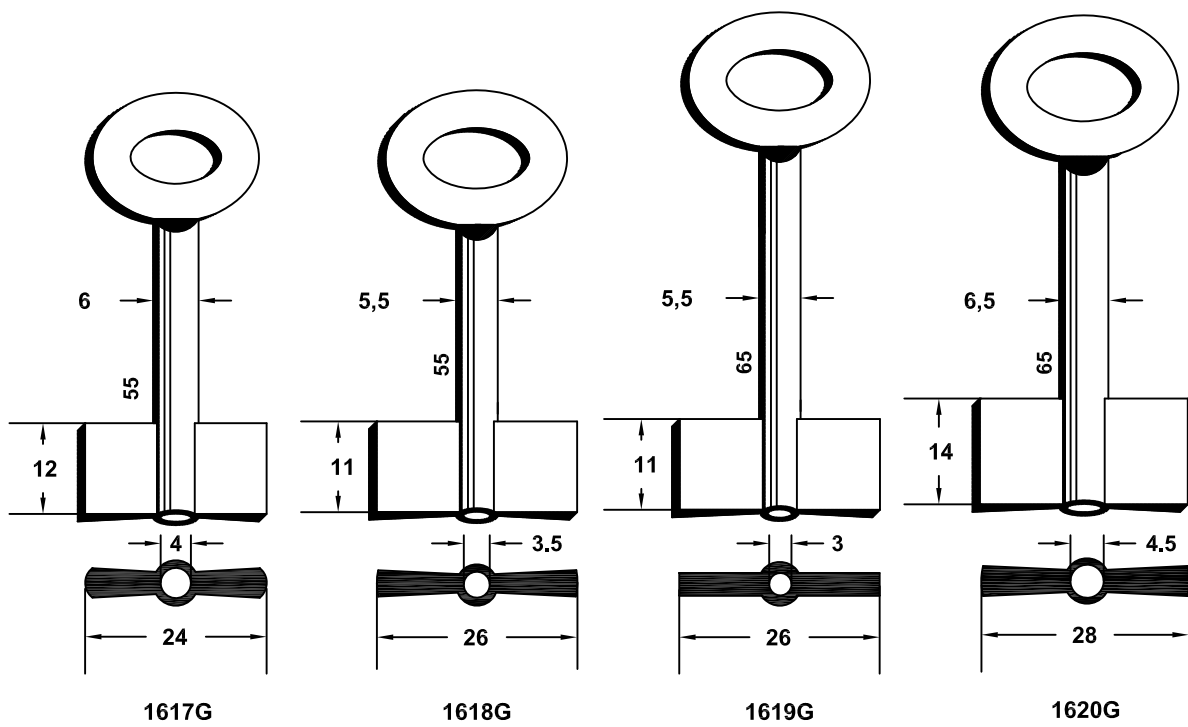

1617G

1618G

1619G

1620G



PARA-FOR:

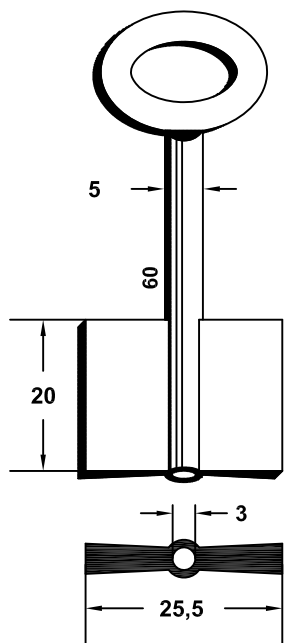

1621G

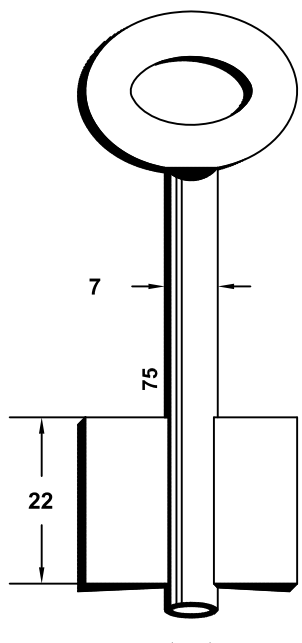

1622G

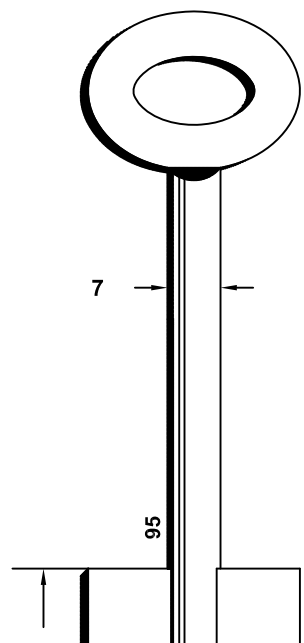

1623G

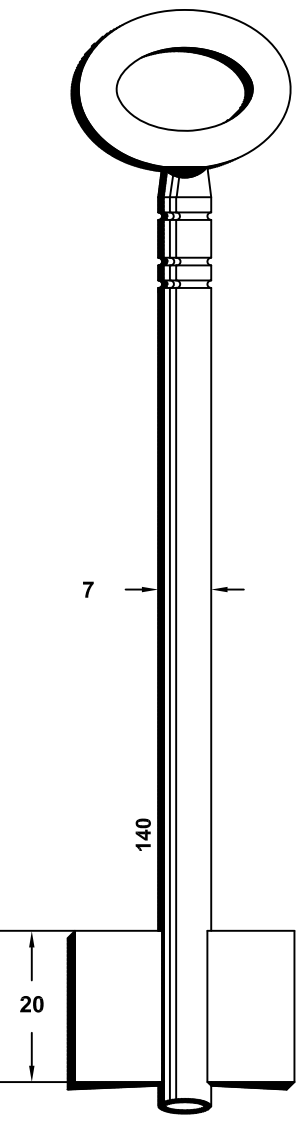

1625G

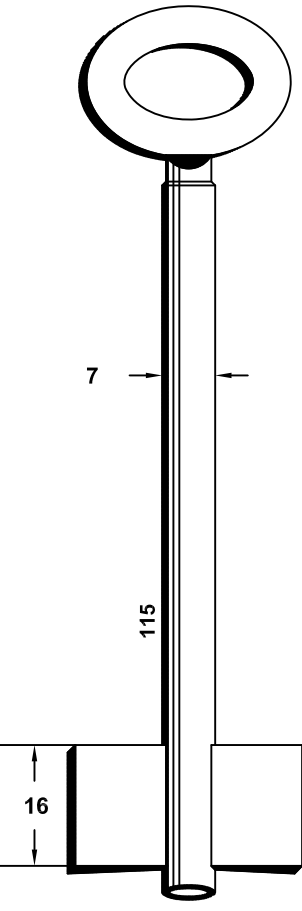

1626G

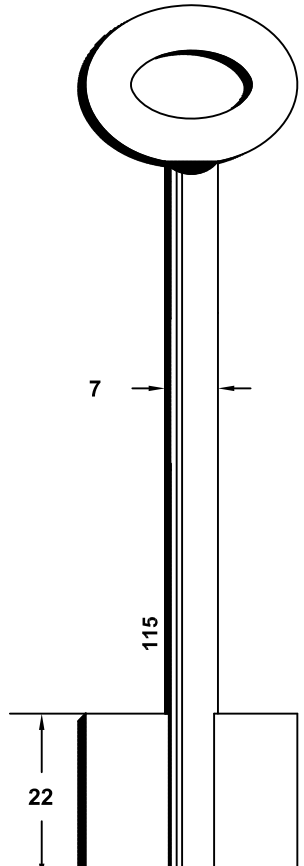

1624G



# **LLAVES DE GORJA LATÓN**

*LETOIZKO GORJA GILTZAK*

*BRASS BIT KEYS*

*CLES A GORGES EN LAITON*

*CHUBBSCHLÜSSEL AUS MESSING*



**THE KEY TO EXCELLENCE**  
GLOBALLY UNLOCKING MILLIONS OF DOORS DAILY

PARA-FOR:

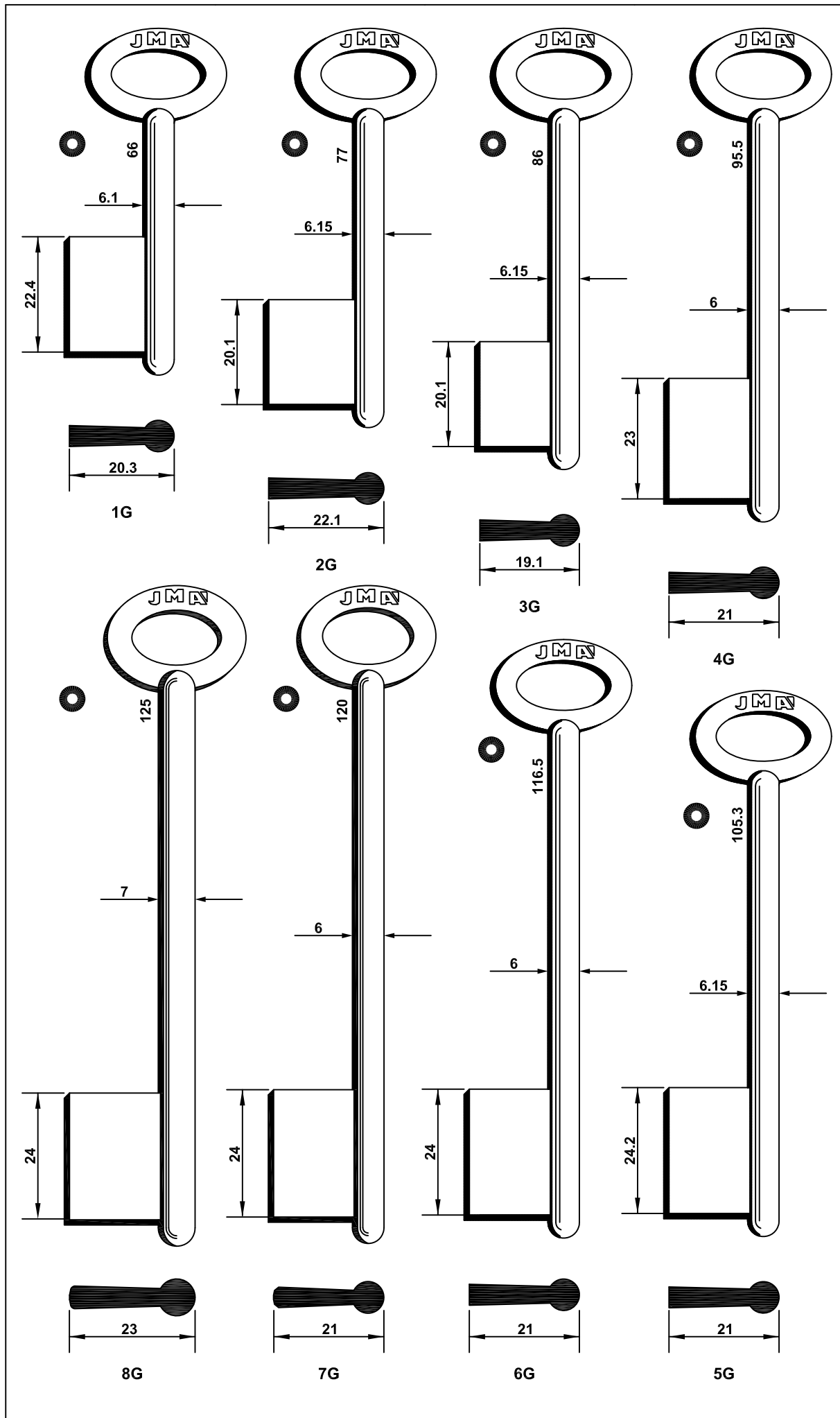

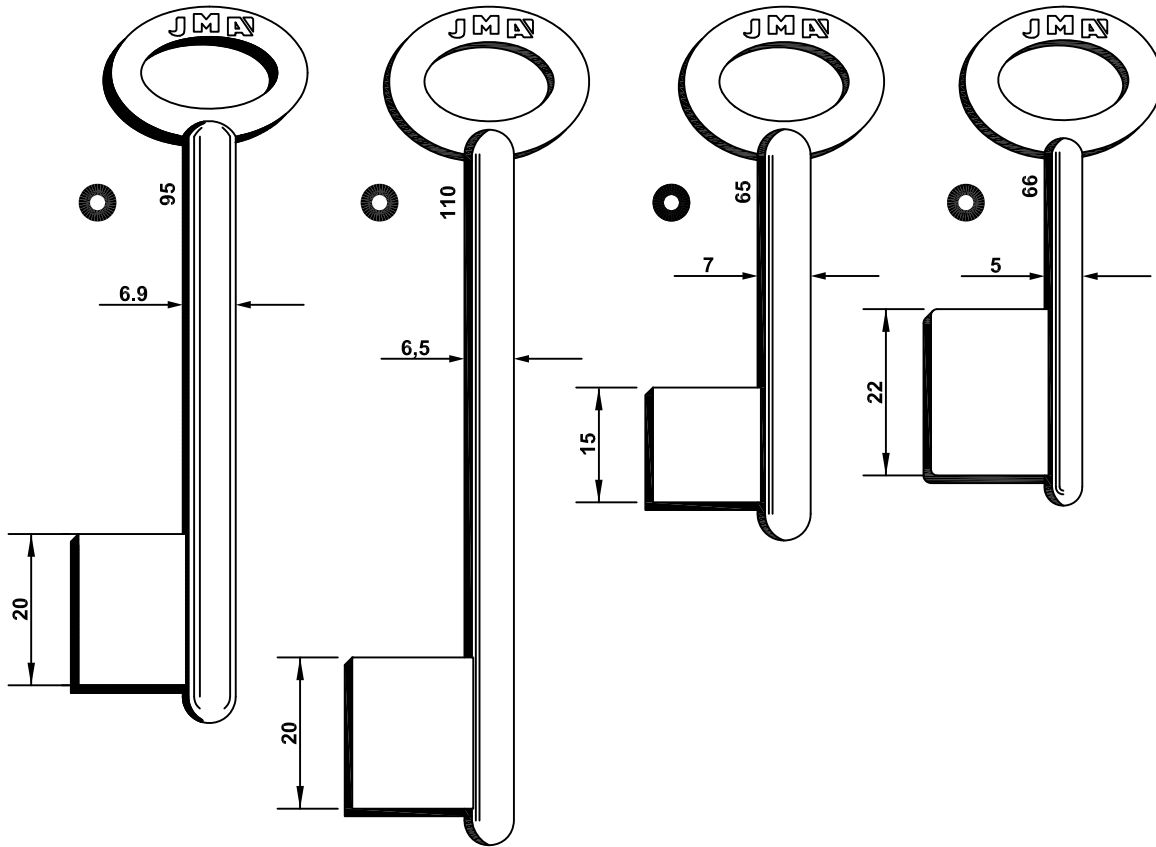

11G

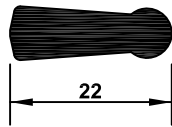

12G

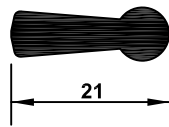

13G

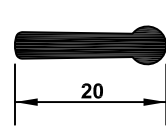

14G

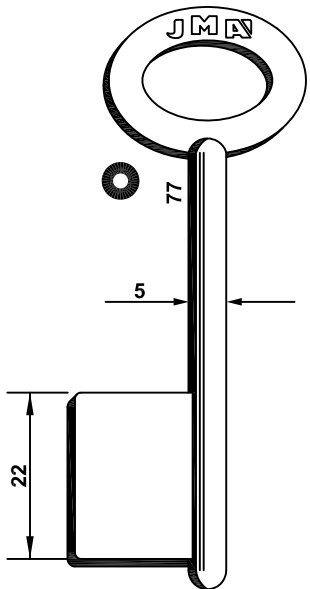

15G

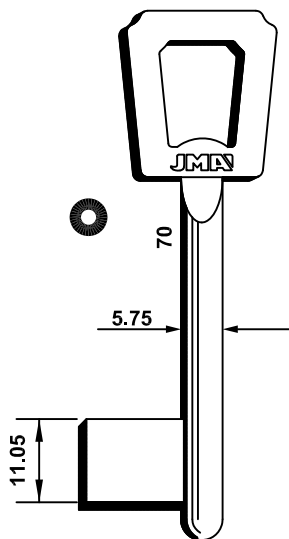

16G

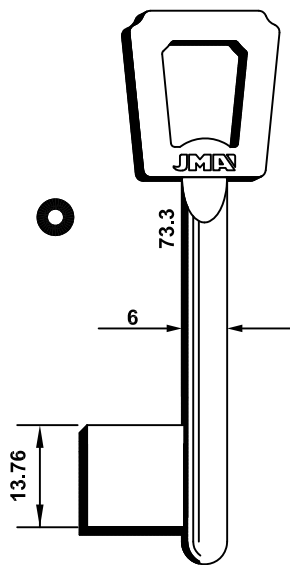

17G

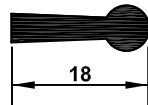
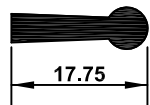
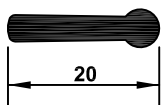

PARA-FOR:

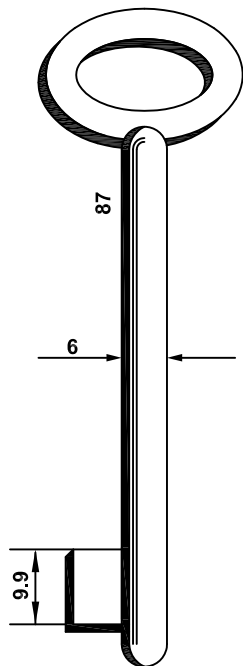

19G

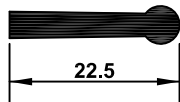
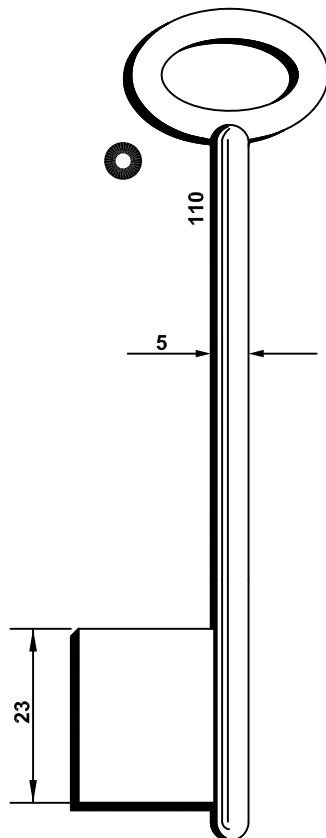

21G

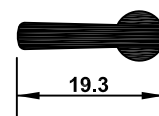
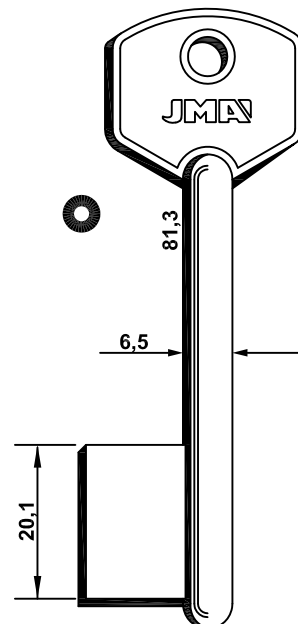

23G

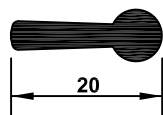
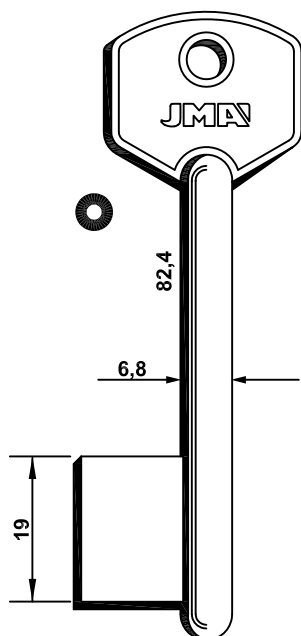

24G

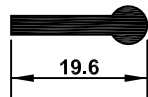
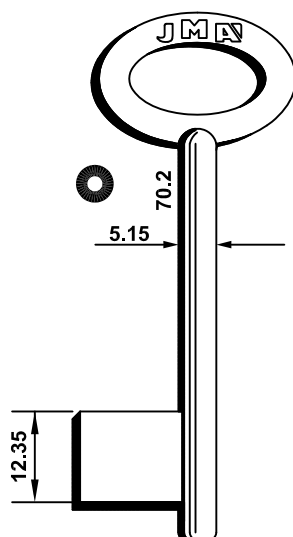

25G



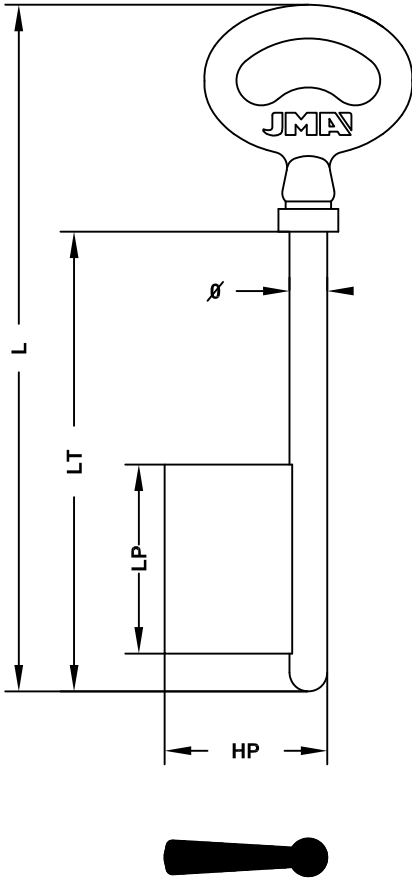

REF.	Ø	L	LT	LP	HP
AD-3	5	90	60	25	21,5
AD-4	5	95	65	25	21,5
AD-5	5	100	70	25	21,5
AD-16	5	110	80	30	21,5
AD-17	5	120	89	35	21,5
AD-6	5,5	80	59	25	22
AD-7	5,5	95	64	25	22
AD-18	5,5	95	64	30	22
AD-8	5,5	100	70	25	21,5
AD-19	5,5	110	80	30	22
AD-20	5,5	120	89	35	22
AD-1	5,8	75	43	18	14
AD-9	5,8	80	50	25	19
AD-21	5,8	95	65	30	22
AD-10	6	90	59	25	22
AD-11	6	95	65	25	22
AD-12	6	100	70	25	22
AD-23	6	110	80	30	22
AD-24	6	120	88	35	22
AD-25	6	140	108	35	22
AD-26	6,5	95	65	30	23
AD-13	6,5	100	70	25	22
AD-29	6,5	100	70	30	23
AD-27	6,5	110	80	30	23
AD-28	6,5	120	90	35	23

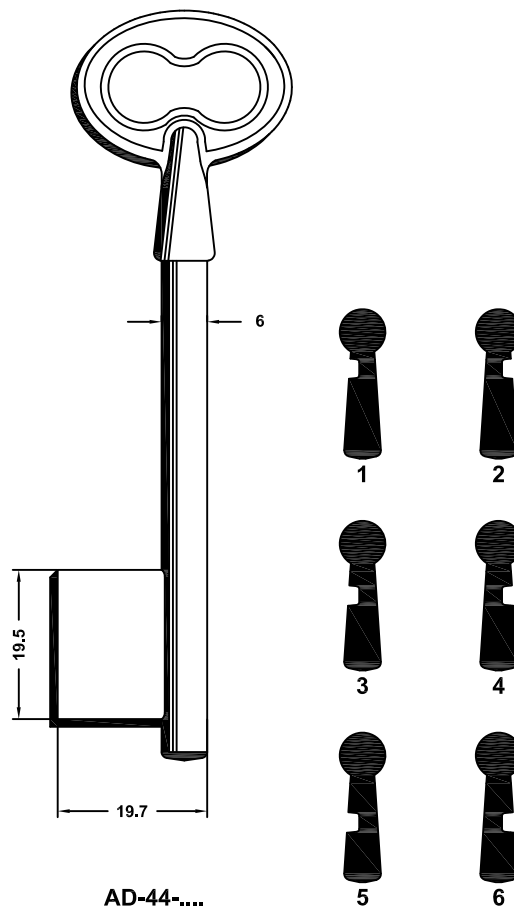
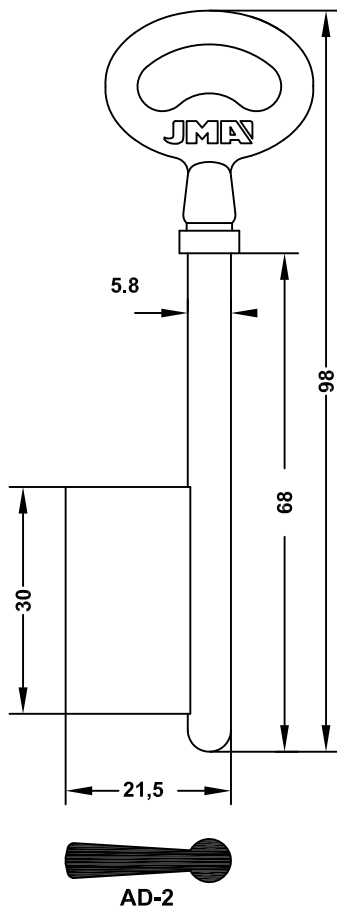

**PARA-FOR:**

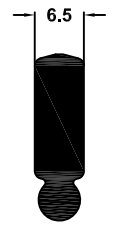

**ADPLE-11**

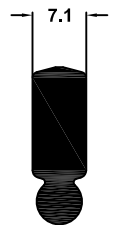
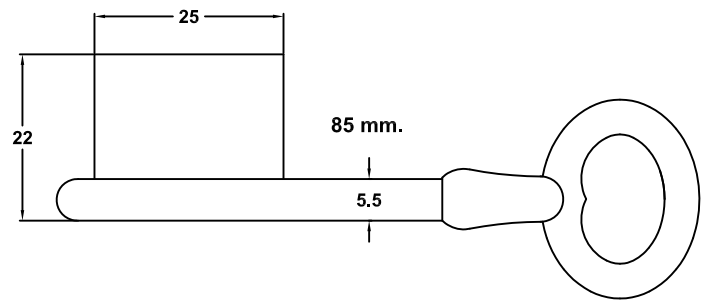

**ADPLE-22**

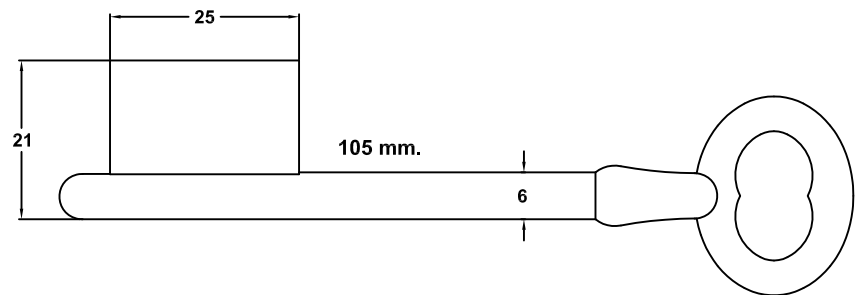

**ADPLE-33**

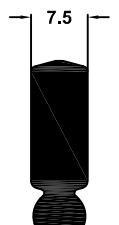
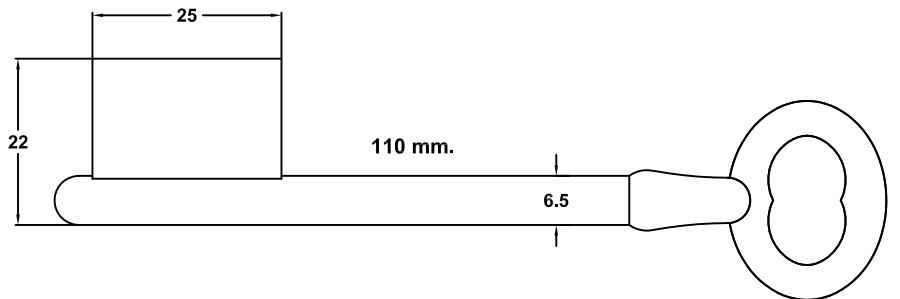

**ADPLE-44**

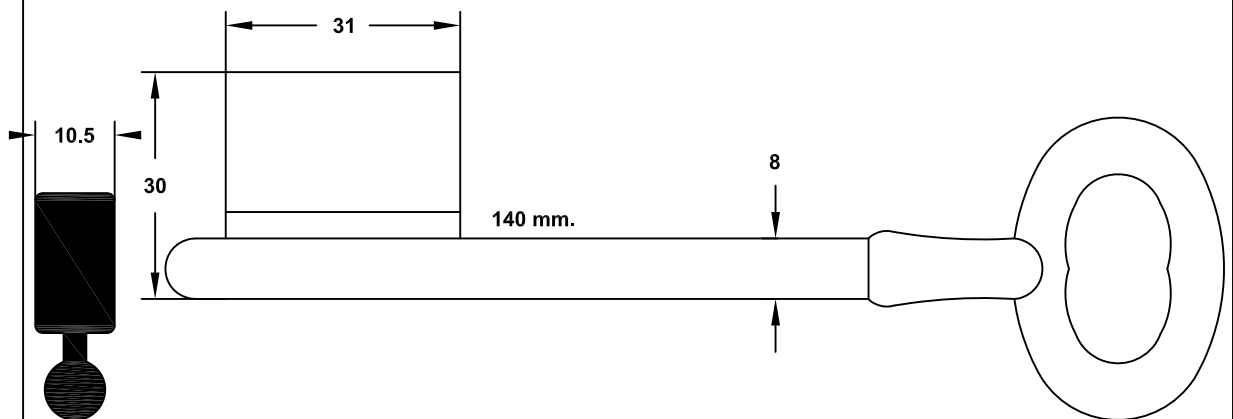
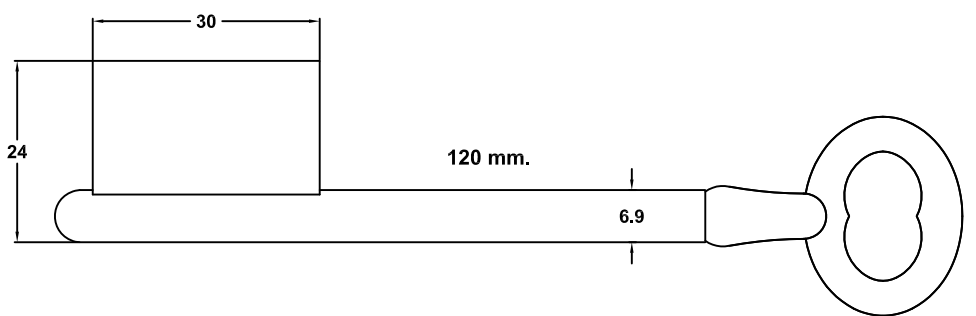

**ADPLE-55**





126

AGA

PARA-FOR:

126 (S)

AGA (E)

ASSA (S)

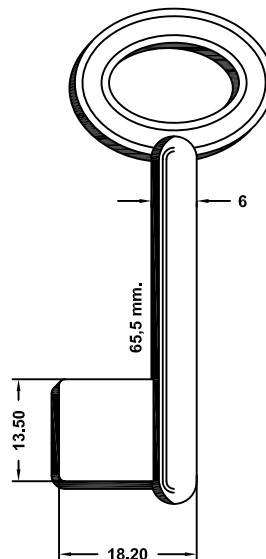
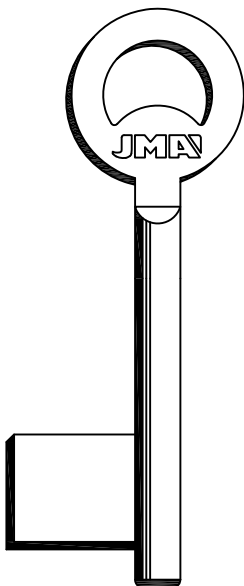
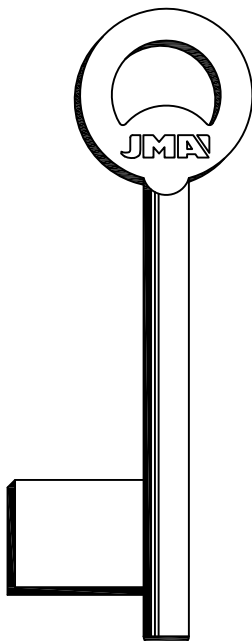
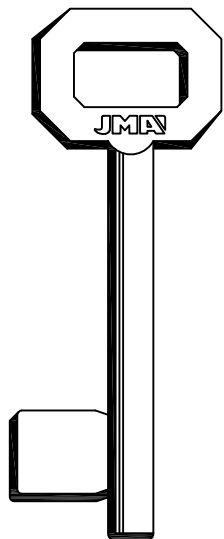

126H-60G



126N-60G



126PP-60G



AGA-1G

ASSA

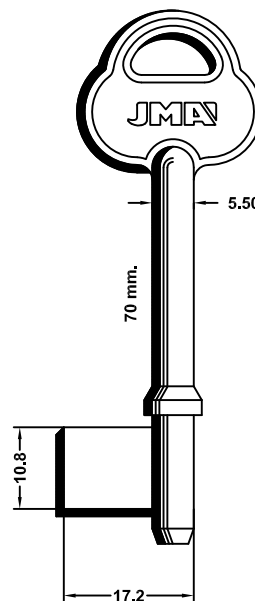
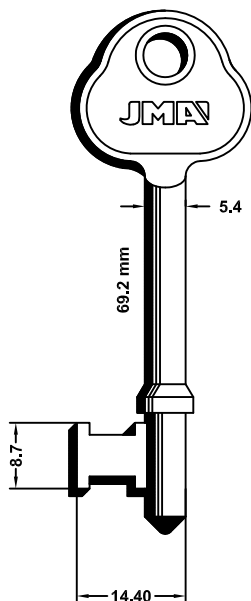
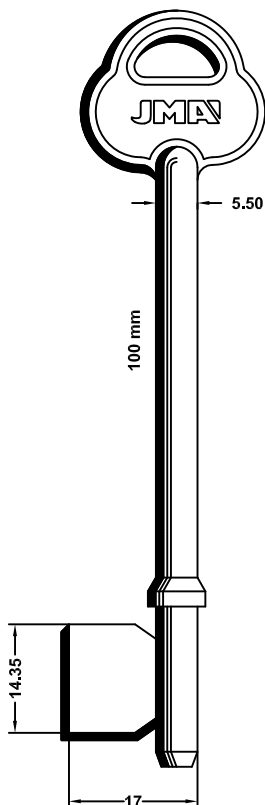
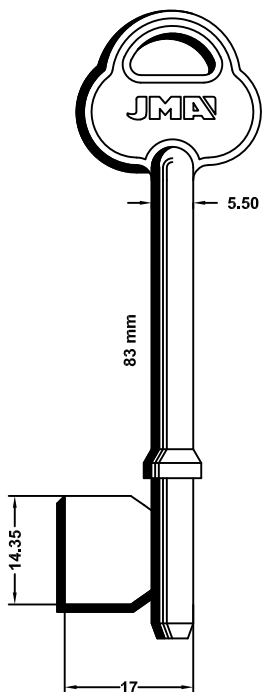

AS-1G



AS-2G



AS-3G



AS-6G/1



**PARA-FOR:**

ASSA (S)

BODA (SF)

BRICARD (F)

CHUBB (GB)

**ASSA**

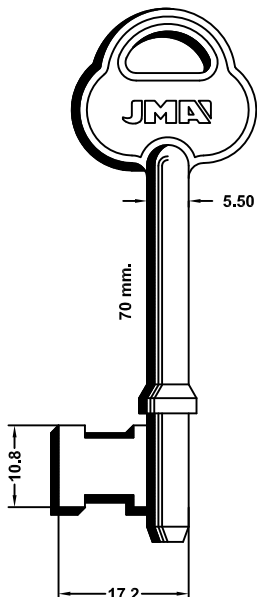

AS-6G/2

**BODA**

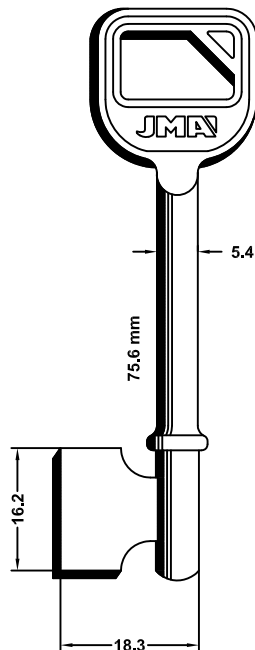

BOD-4G

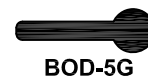
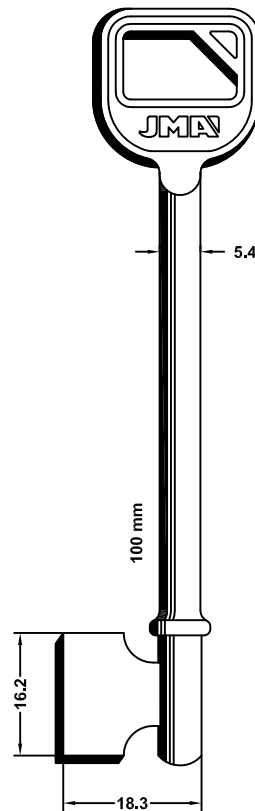

BOD-5G

**BRICARD**

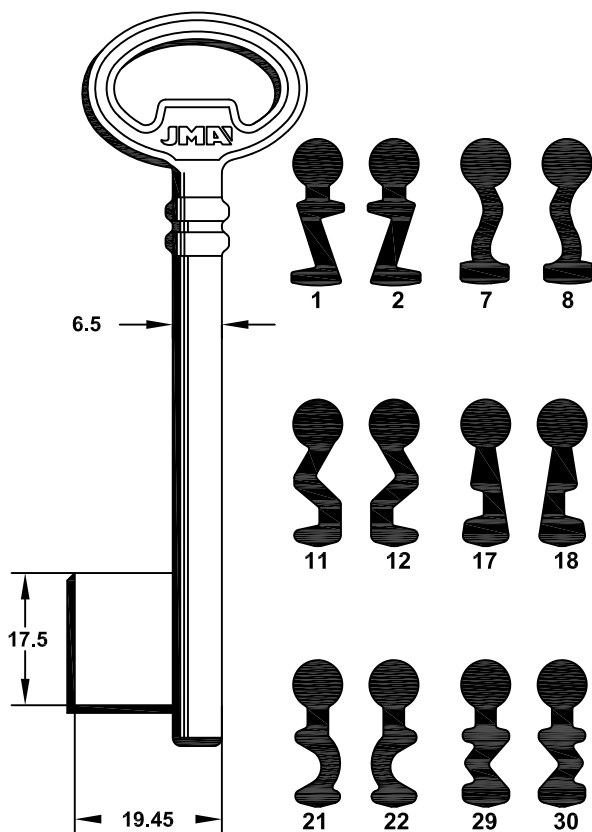

BRI-6L...

**CHUBB**

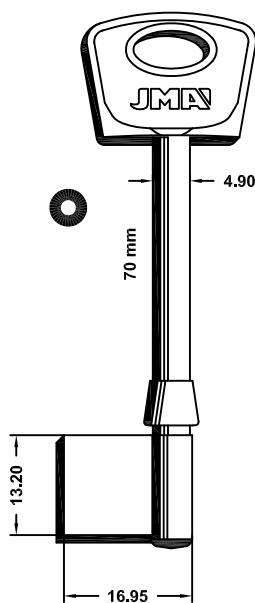

CHU-1G

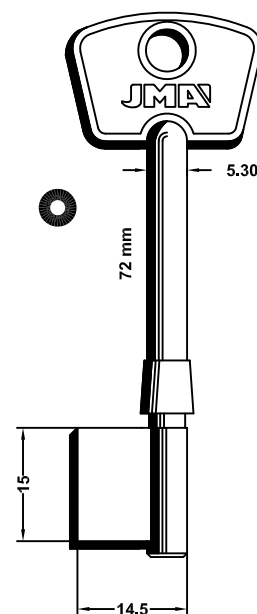

CHU-2G



**DAR-MAR**

**PARA-FOR:**  
 DAR-MAR (PL)  
 DEBEAURAIN (F)  
 ELZETT (H)

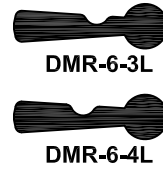
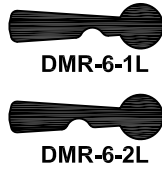
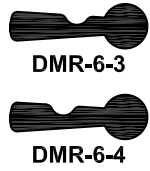
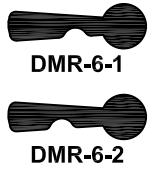
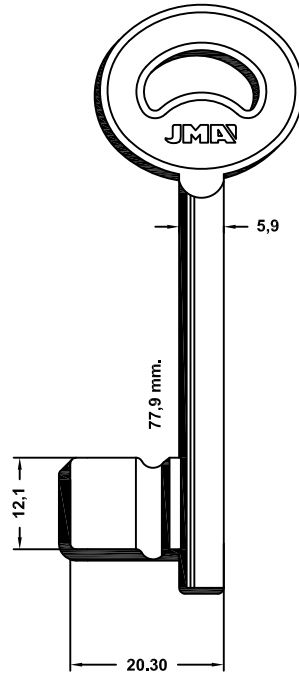
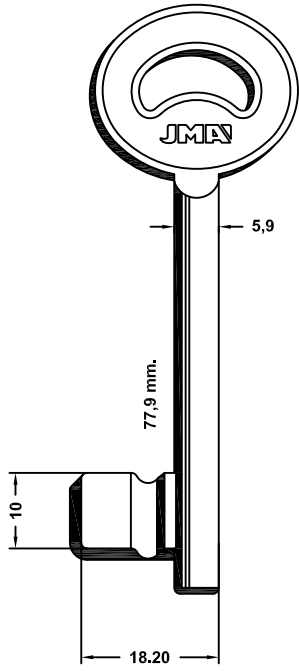

**DAR-MAR**





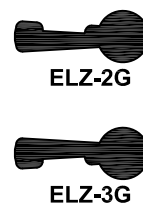
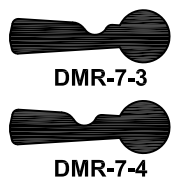
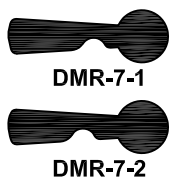
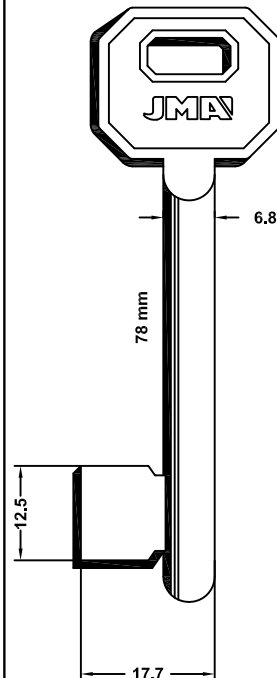
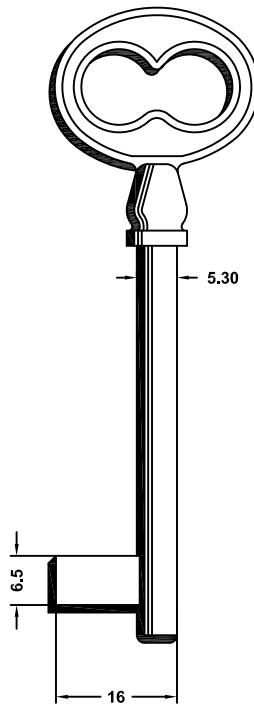
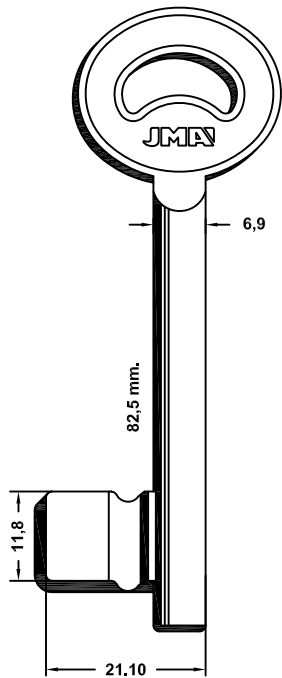





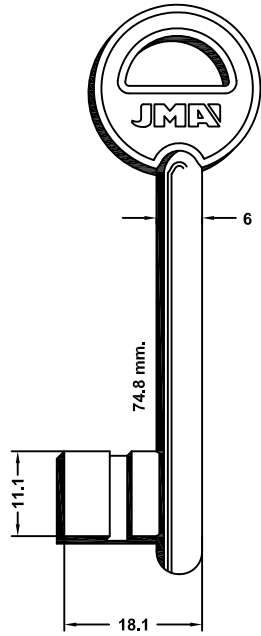
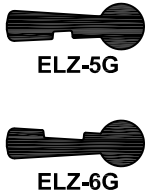
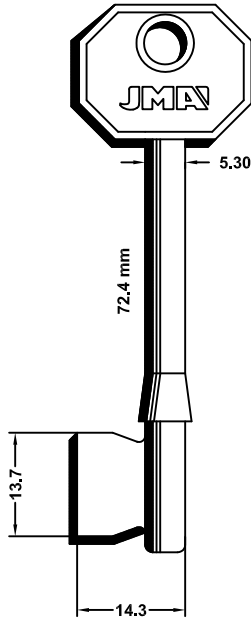

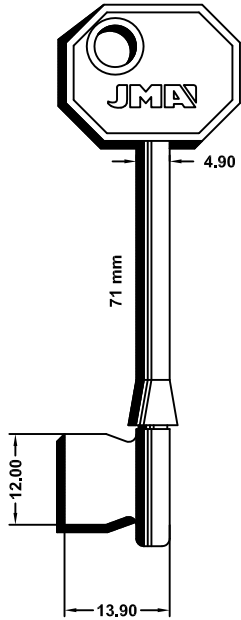

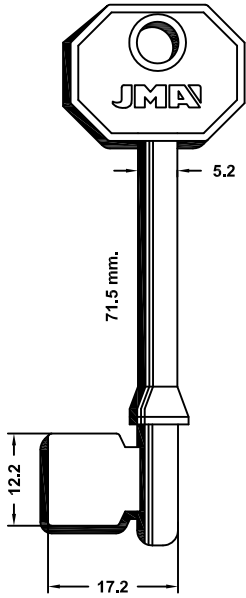
**DEBEAURAIN**

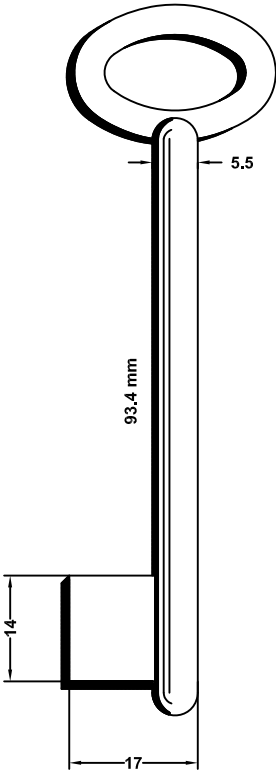
**ELZETT**

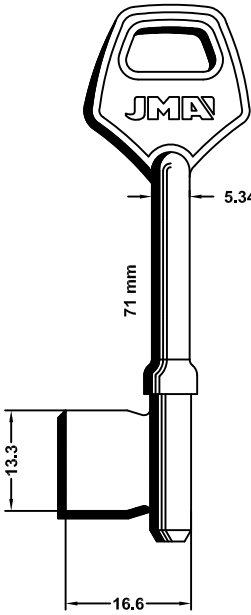

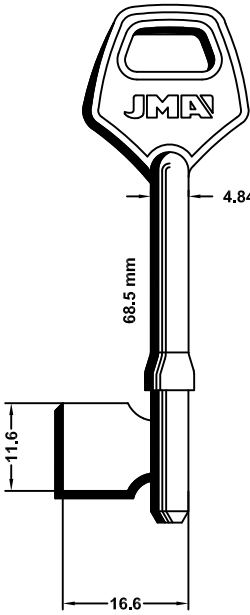
**PARA-FOR:**

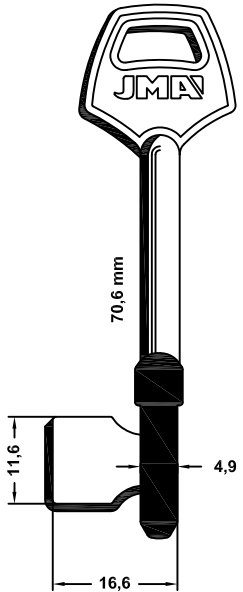
- ELZETT (H)
- ERA (GB)
- ESA (E)
- FAS-YALE (S)

ELZETT	ERA		
 <p>74.8 mm.</p> <p>11.1</p> <p>18.1</p> <p>6</p>  <p>ELZ-5G</p> <p>ELZ-6G</p>	 <p>72.4 mm</p> <p>13.7</p> <p>14.3</p> <p>5.30</p>  <p>ER-1G</p>	 <p>71 mm</p> <p>12.00</p> <p>13.90</p> <p>4.90</p>  <p>ER-4G</p>	 <p>71.5 mm.</p> <p>12.2</p> <p>17.2</p> <p>5.2</p>  <p>ER-5G</p>
ESA	FAS-YALE		
 <p>93.4 mm</p> <p>14</p> <p>17</p> <p>5.5</p>  <p>ES-1G</p>	 <p>71 mm</p> <p>13.3</p> <p>16.6</p> <p>5.34</p>  <p>FA-1G</p>	 <p>68.5 mm</p> <p>11.6</p> <p>16.6</p> <p>4.84</p>  <p>FA-2G</p>	 <p>70.6 mm</p> <p>11.6</p> <p>16.6</p> <p>4.9</p>  <p>FA-2PPG</p>



# FAS-YALE

# PARA-FOR:

FAS-YALE (S)

FICHET (F)

GPZ (RUS)

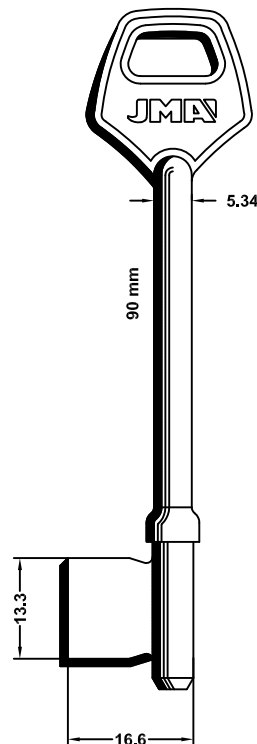
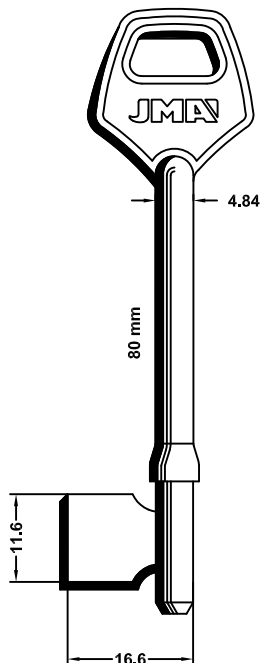
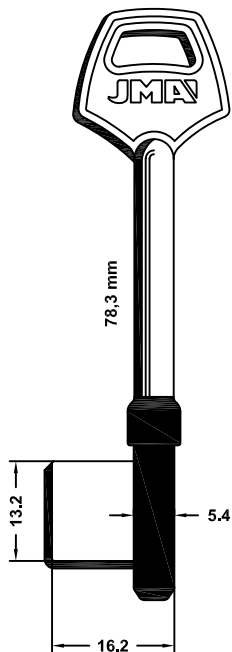
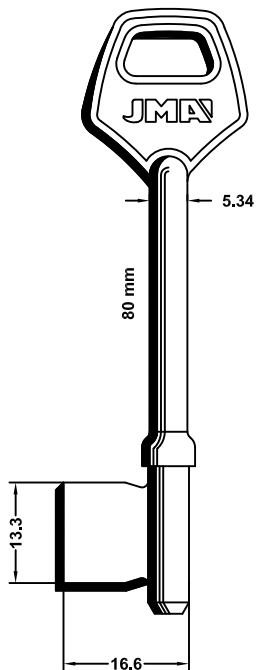

## FAS-YALE





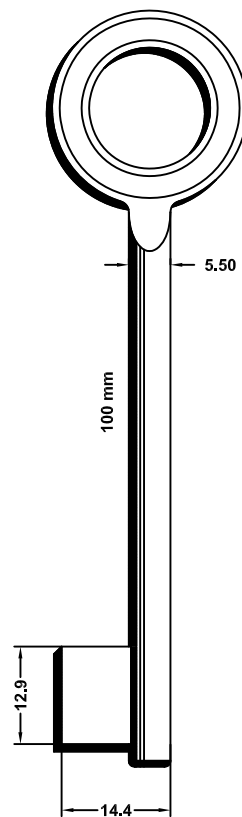
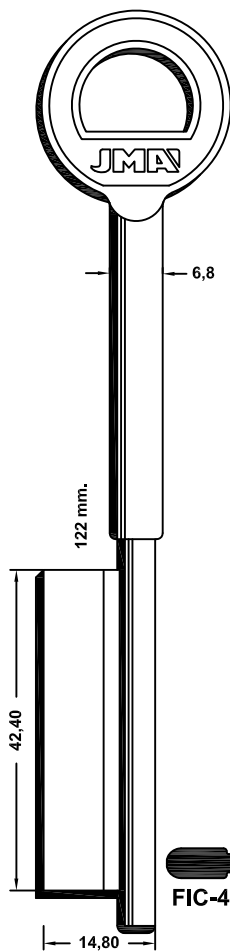
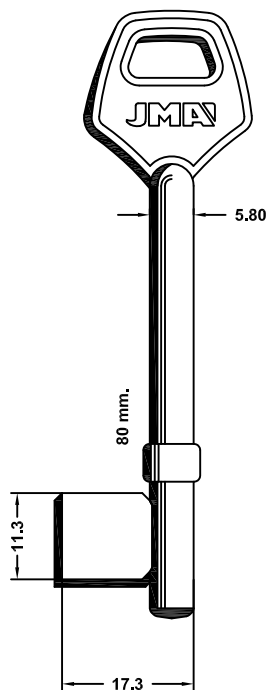
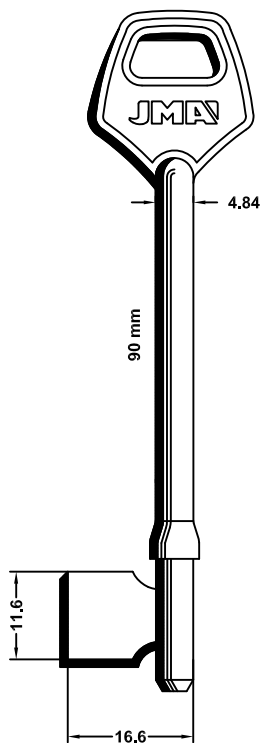





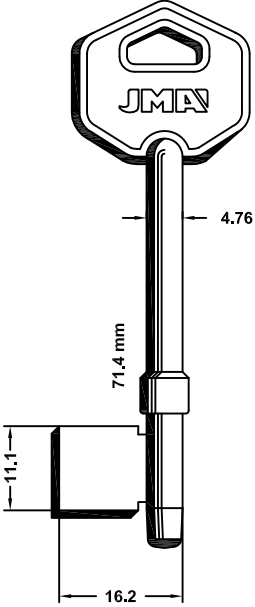

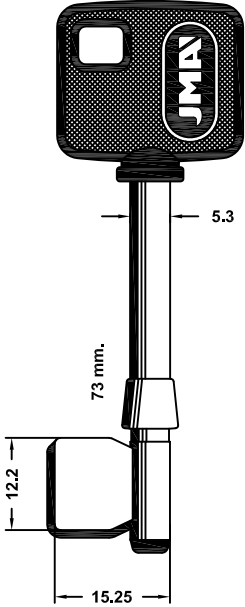

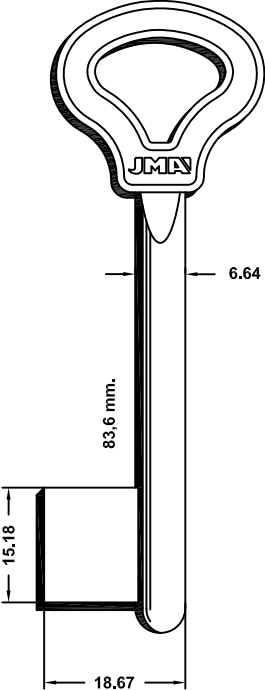

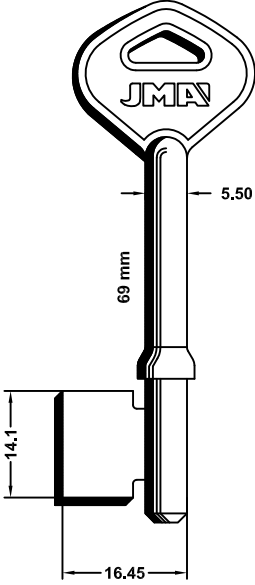
## FICHET

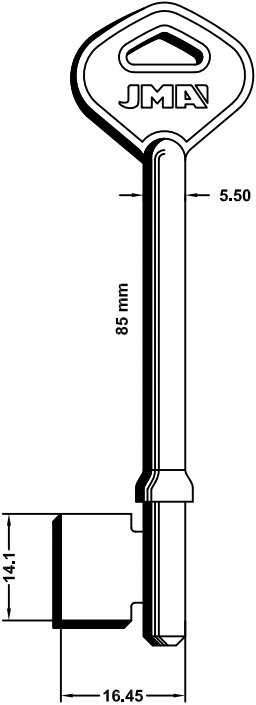
## GPZ

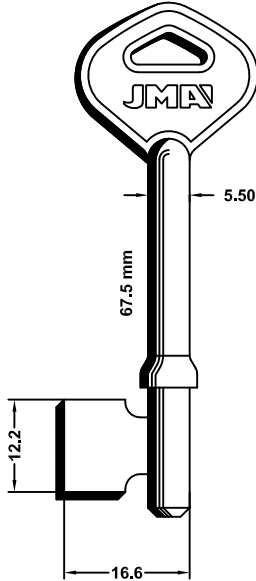

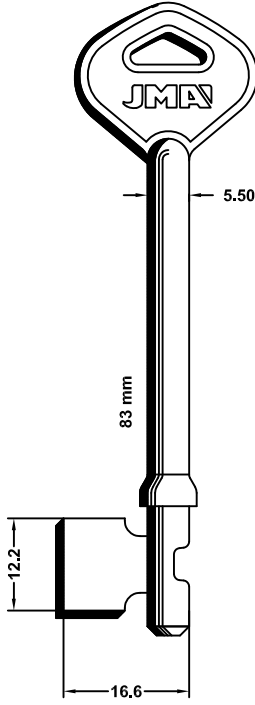
**PARA-FOR:**

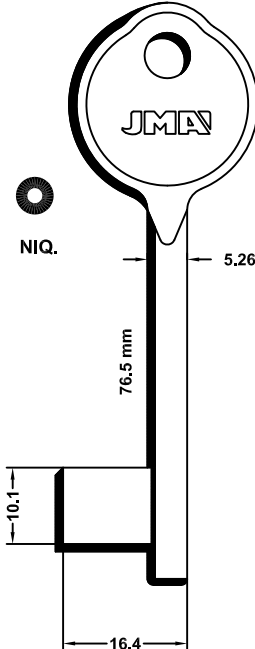
- GUARDIAN (GB)
- HENDERSON (GB)
- LAR (E)
- LÅSBOLAGET (S)
- MCM (E)

GUARDIAN	HENDERSON	LAR	LÅSBOLAGET
 <p>4.76 71.4 mm 11.1 16.2</p>  <p><b>GUR-1G</b></p>	 <p>5.3 73 mm. 12.2 15.25</p>  <p><b>HEN-1G.P</b></p>	 <p>6.64 83.6 mm. 15.18 18.67</p>  <p><b>LAR-1G</b></p>	 <p>5.50 69 mm 14.1 16.45</p>  <p><b>LASB-1G</b></p>
LÅSBOLAGET			MCM
 <p>5.50 85 mm 14.1 16.45</p>  <p><b>LASB-2G</b></p>	 <p>5.50 67.5 mm 12.2 16.6</p>  <p><b>LASB-3G</b></p>	 <p>5.50 83 mm 12.2 16.6</p>  <p><b>LASB-4G</b></p>	 <p>NIQ. 5.26 76.5 mm 10.1 16.4</p>  <p><b>MCM-1G</b></p>



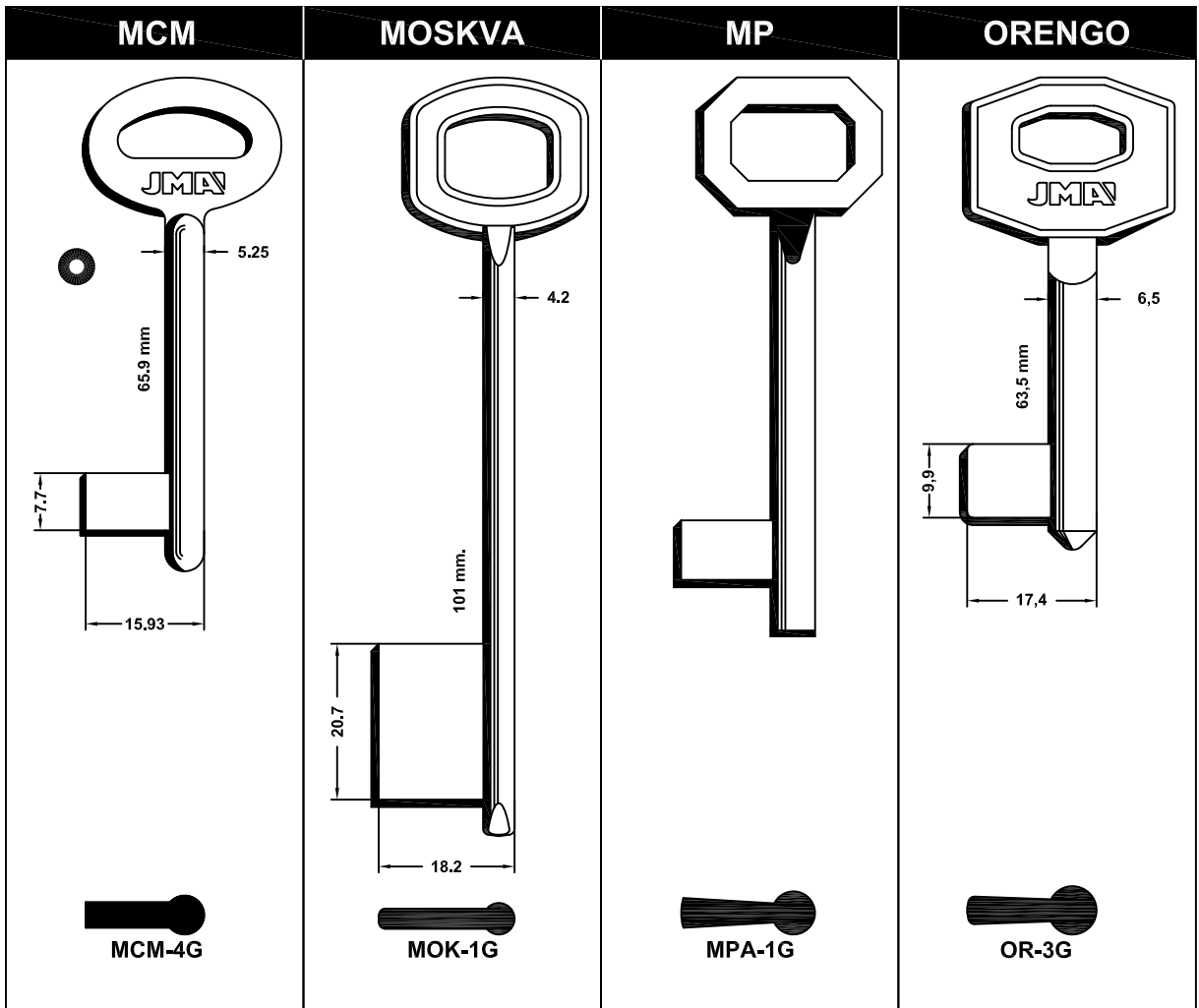

**PARA-FOR:**  
MCM (E)  
MOSKVA (RUS)  
MP (I)  
ORENGO (E)  
OSTMARK (D)  
PASSEPARTOUT

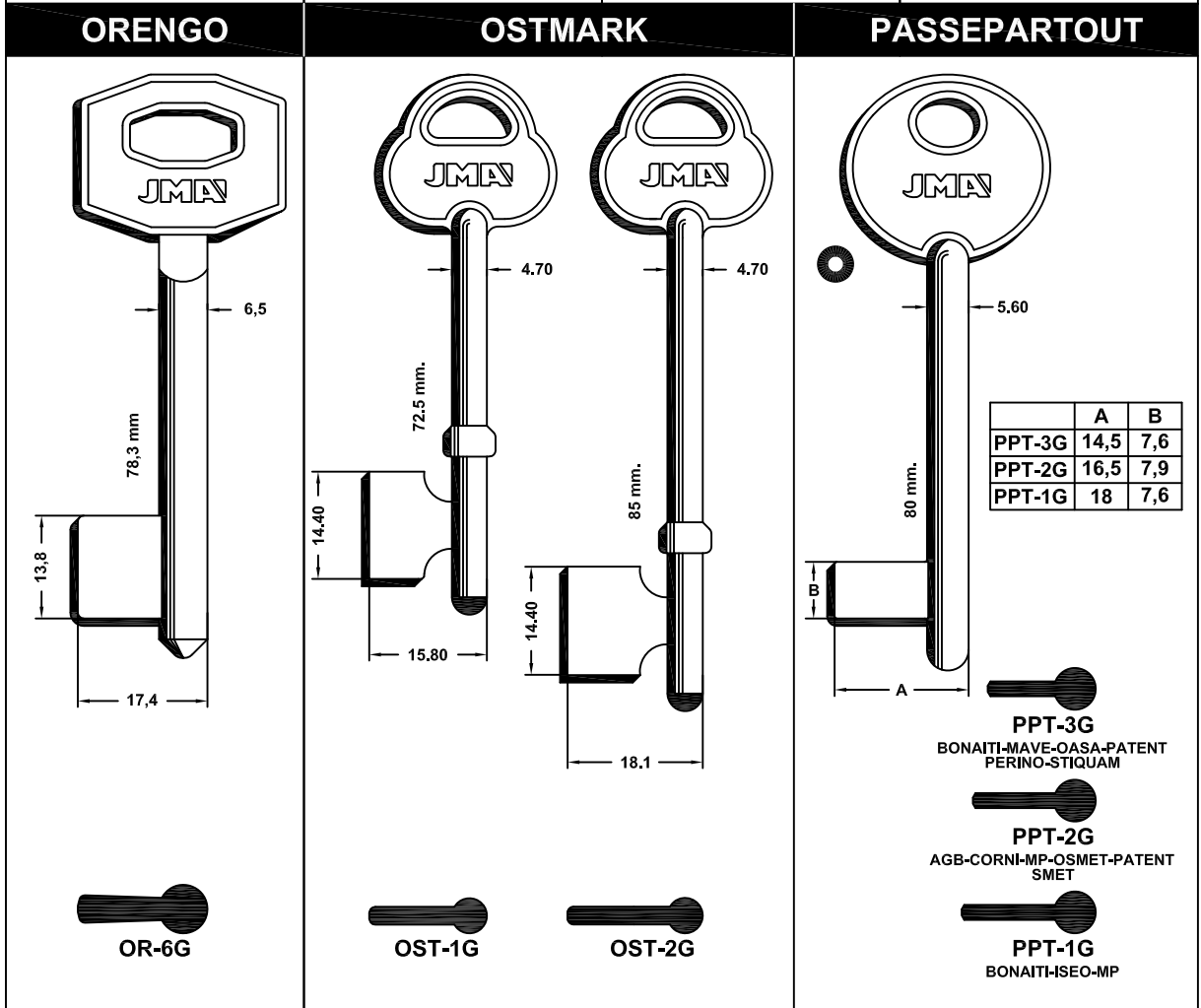

**PARA-FOR:**

- RENAG (N)
- REX (N)
- TESA (E)
- TRIO-VING (N)

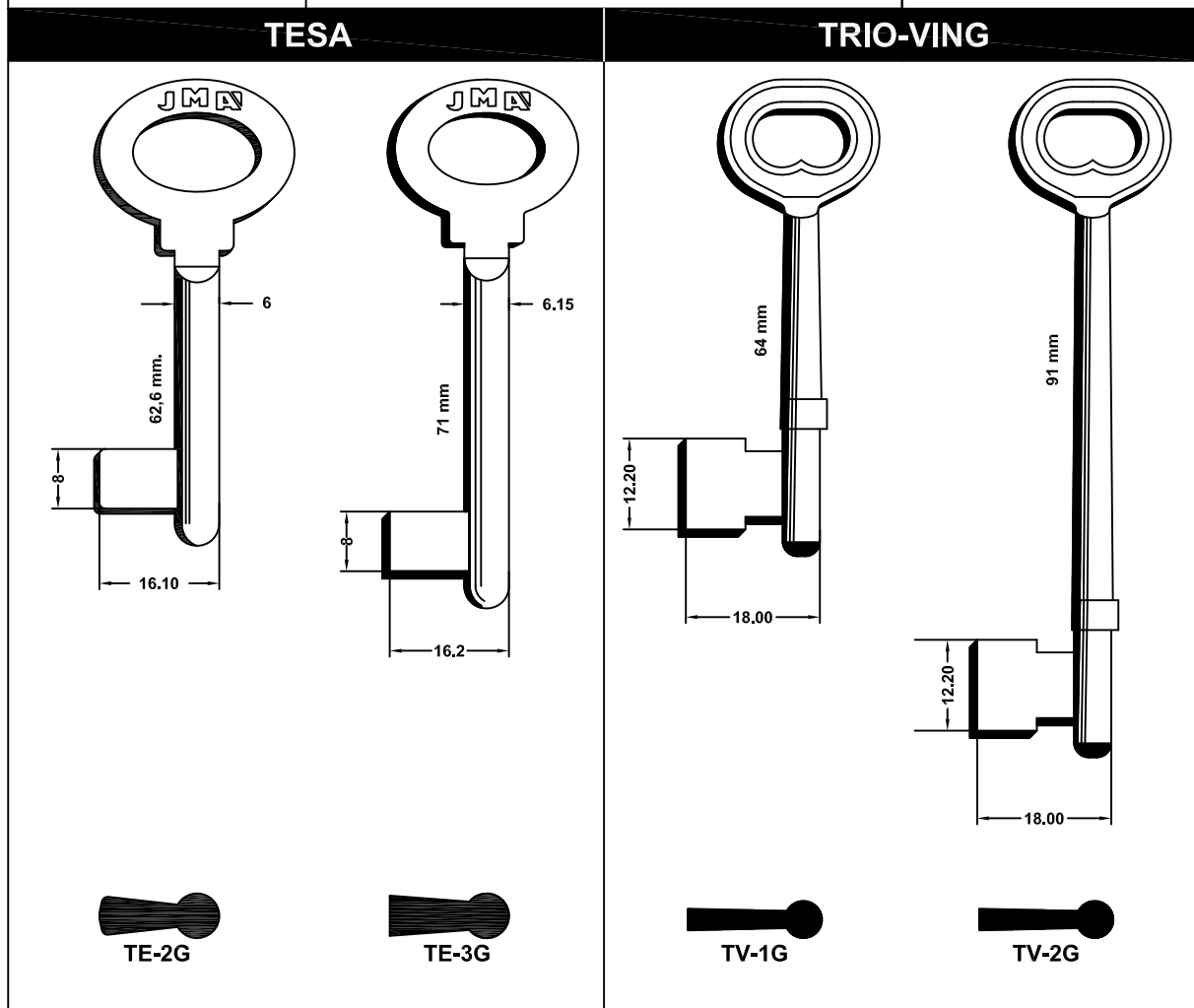
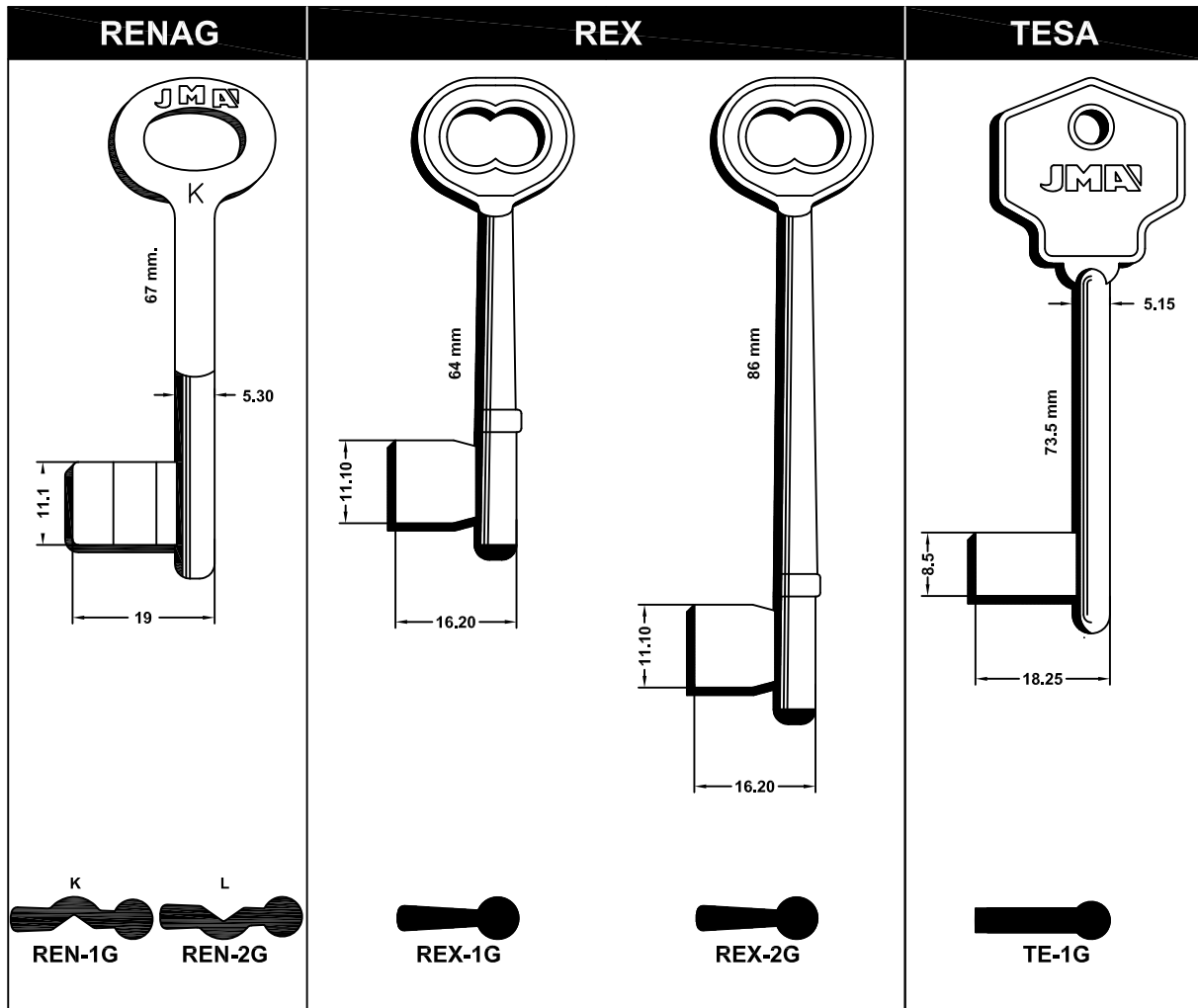



**TRIO-VING**

**PARA-FOR:**

**TRIO-VING (N)**

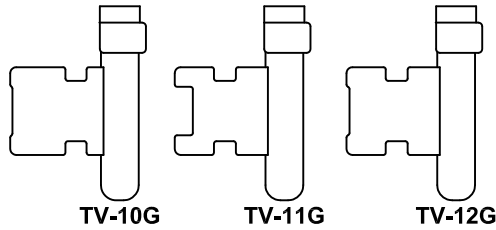
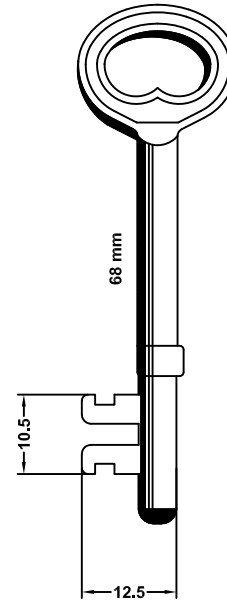
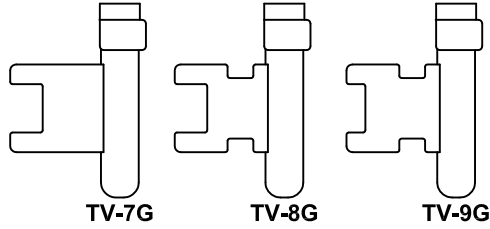
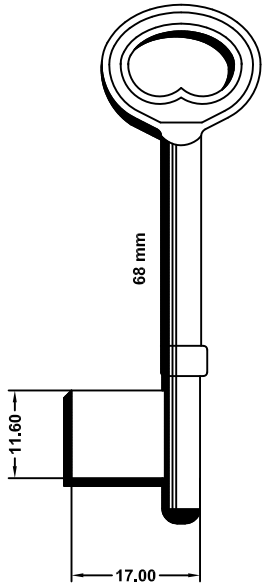

**TV-3G**



**TV-5G**

**TRIO-VING**

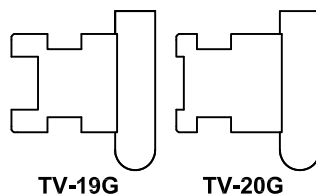
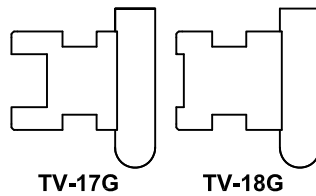
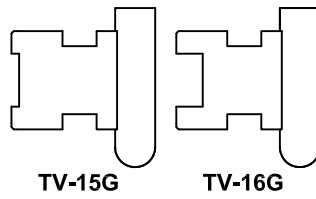
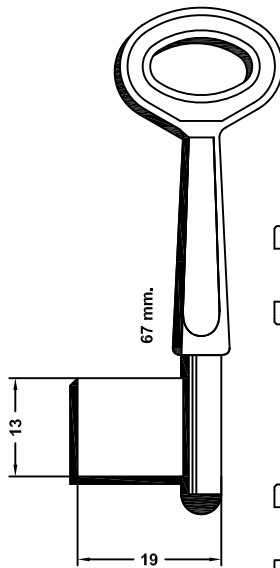
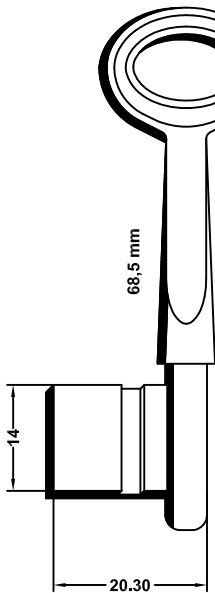

**TV-13G**



**TV-14G**

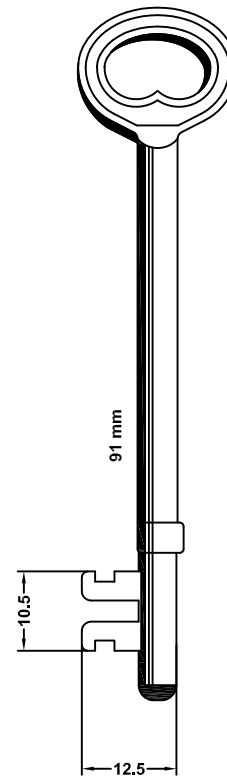

**TV-21G**



**PARA-FOR:**

TRIO-VING (N)

UCEM (E)

UNION (GB)

WMS (GB)

YALE (GB)

TRIO-VING		UCEM	
UCEM	UNION	WMS	YALE



**AKARSAN**

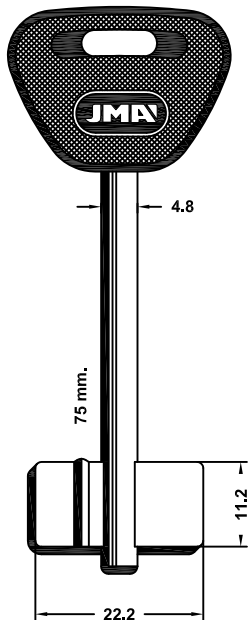

**AKA-1PG**

**ANTONIOLI**

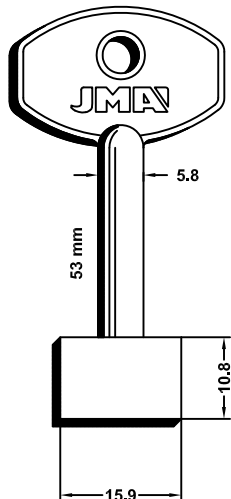

**ANT-1G**

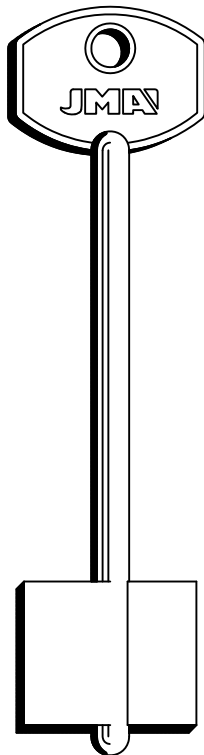

**ANT-2G**

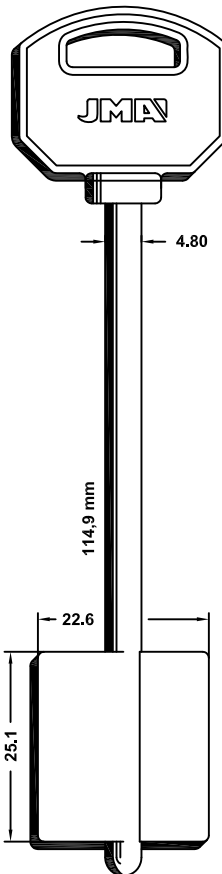

**ANT-3G**

**PARA-FOR:**

AKARSAN (TR)

ANTONIOLI (I)

ASSA (S)

ATRA (I)

**ANTONIOLI**

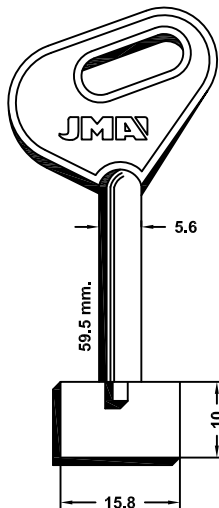

**ANT-4G**

AUNO

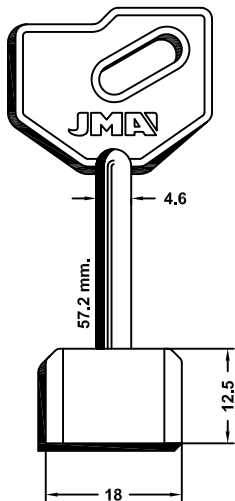

**ANT-5G**

AUNO

**ASSA**

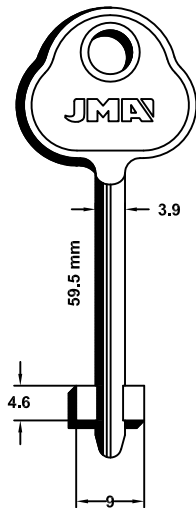

**AS-4G**

**ATRA**

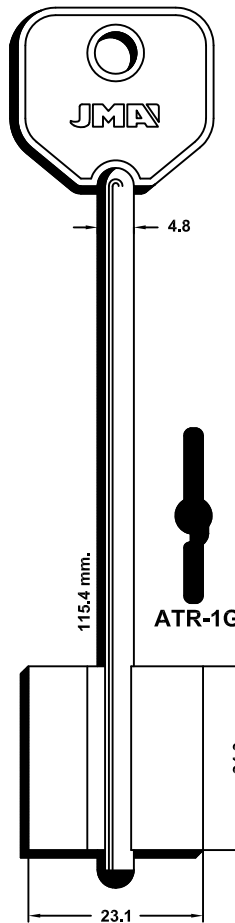

**ATR-1G**



**PARA-FOR:**

ATRA (I)

BETA (I)

**ATRA**

**BETA**

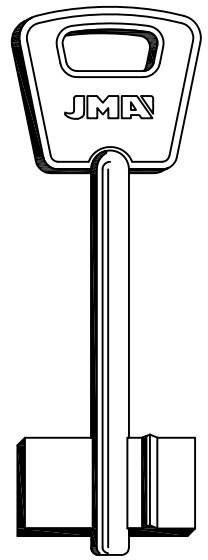
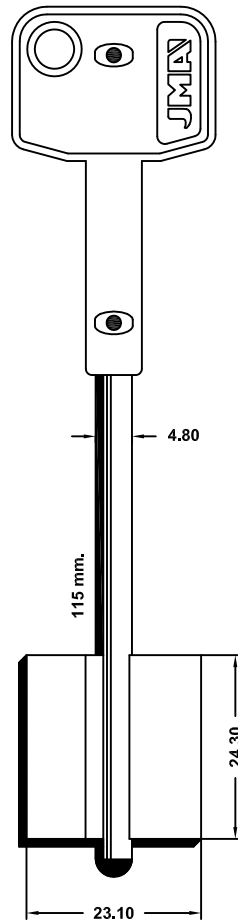
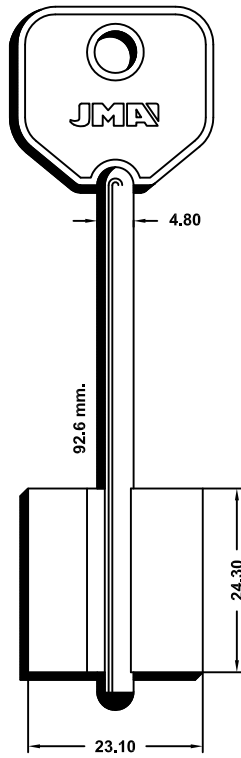

**BETA**

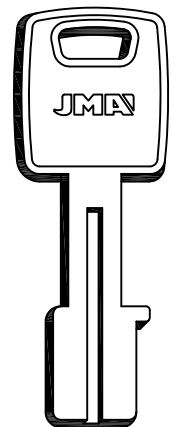
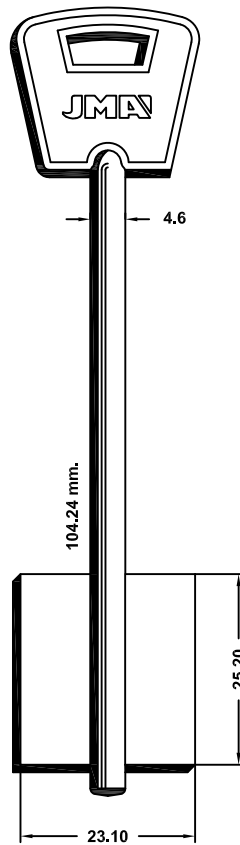
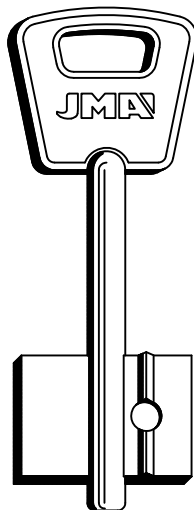

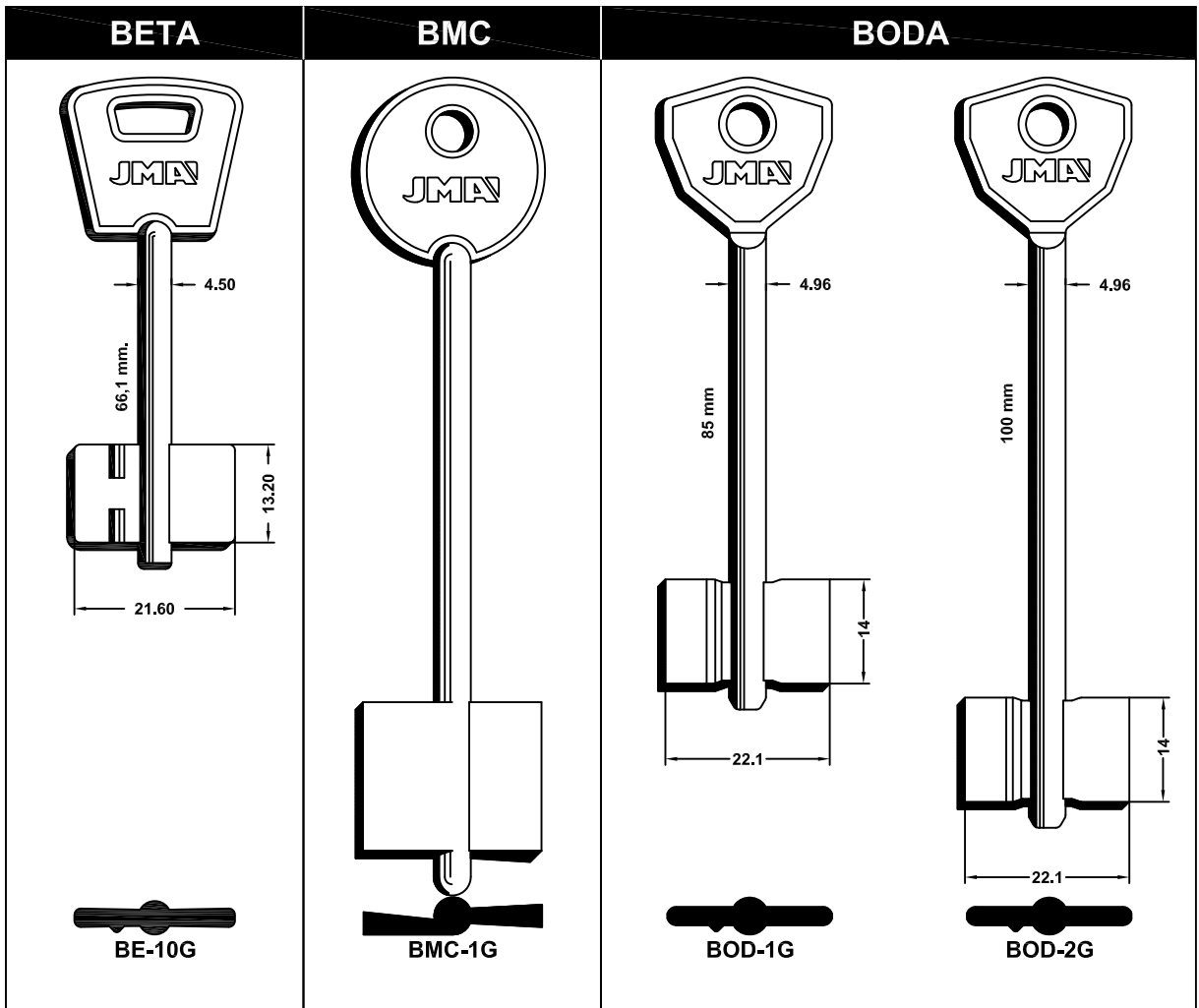

**PARA-FOR:**

- BETA (I)
- BMC (I)
- BODA (SF)
- BOGATIR (RUS)
- BOXAFE (I)

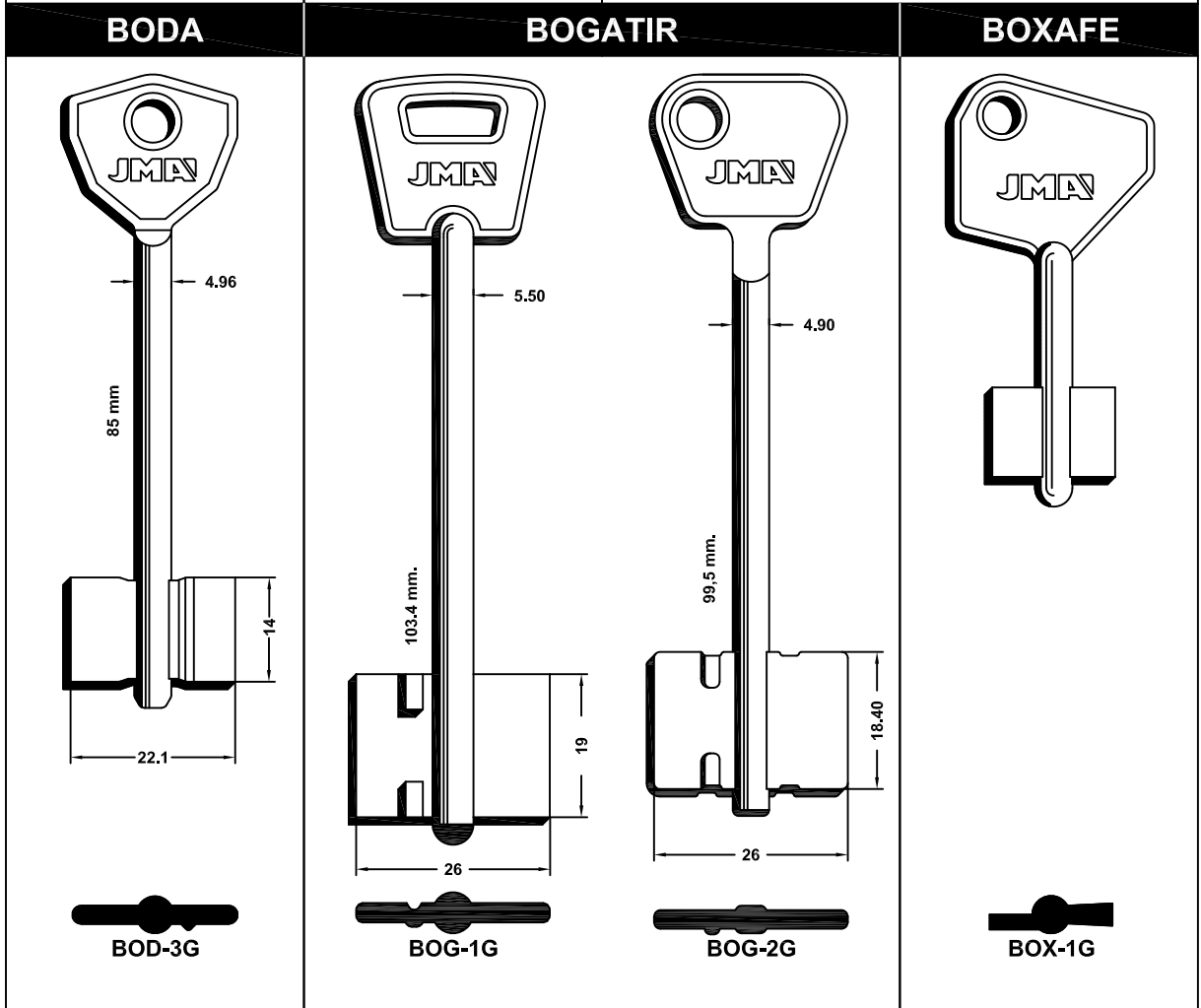

**PARA-FOR:**

CAF (I)

CERUTTI (I)

**CAF**

**CERUTTI**

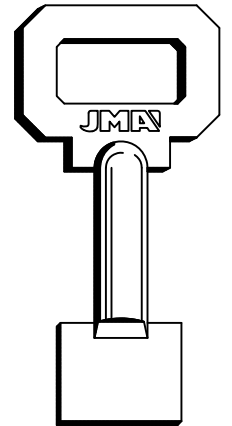
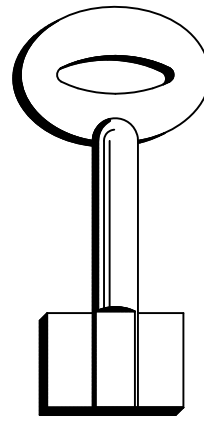
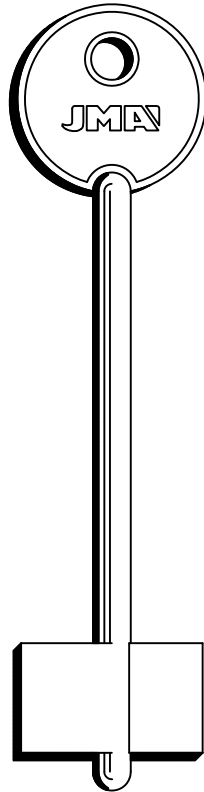
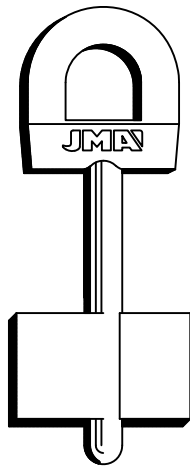

CAF-1G



CAF-2G



CRT-1G



CRT-2G

**CERUTTI**

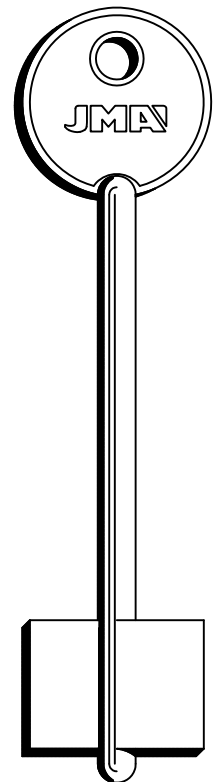
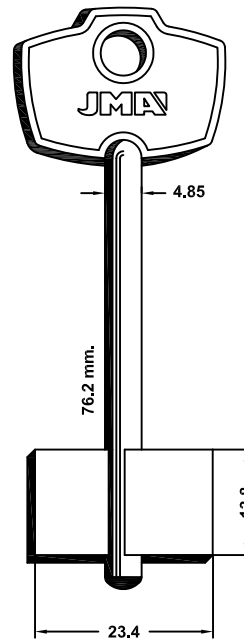
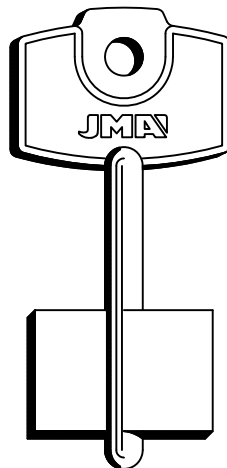
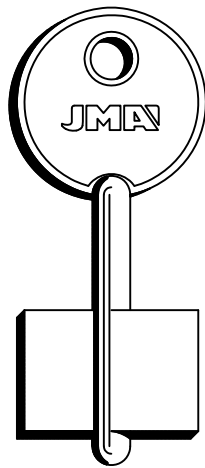

CRT-3G



CRT-4G



CRT-7G



CRT-8G



**CERUTTI**

**PARA-FOR:**

CERUTTI (I)

CHUBB (GB)

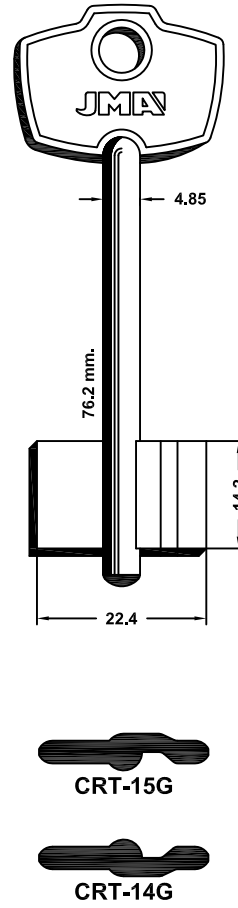
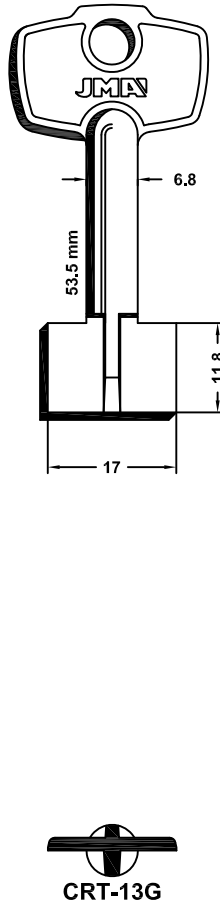
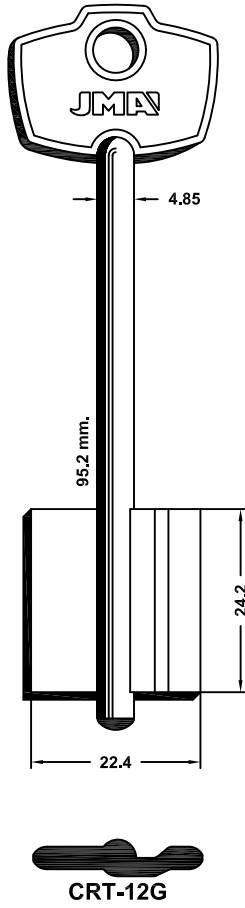
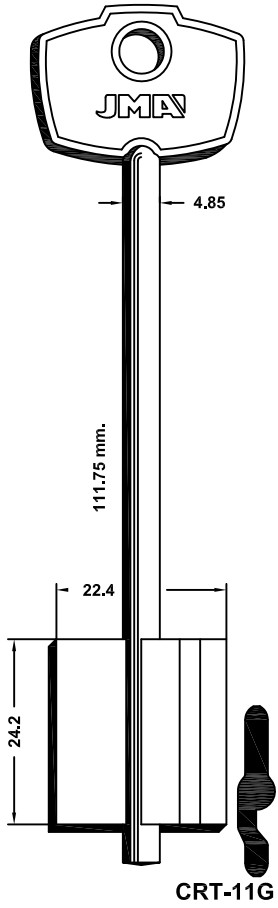

**CERUTTI**

**CHUBB**

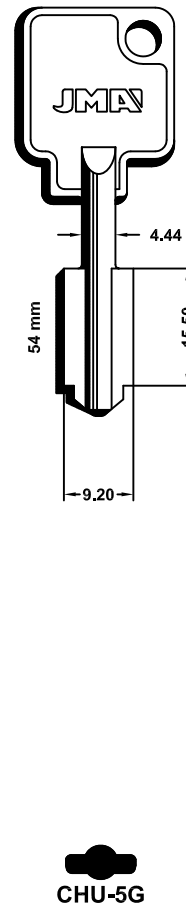
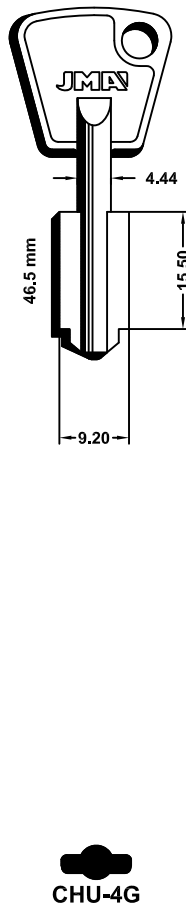
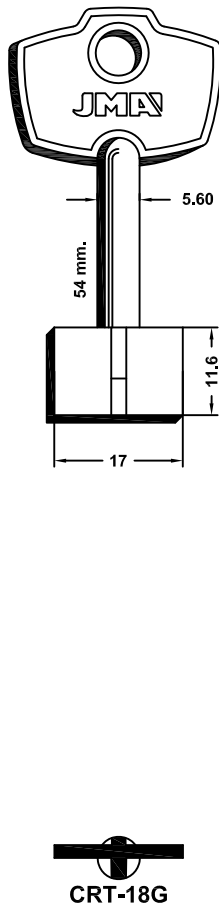
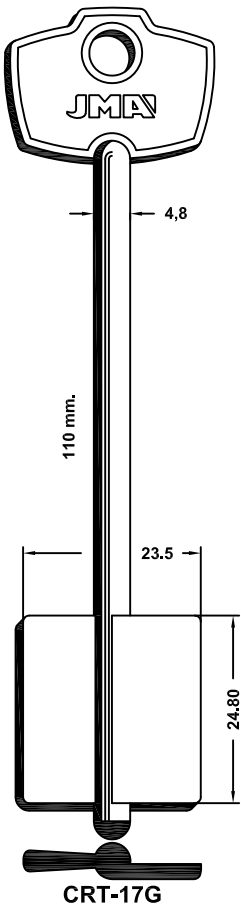

PARA-FOR:

CISA (I)

CISA

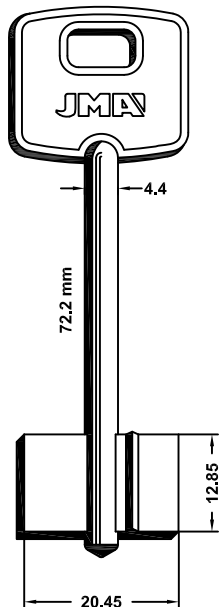

CI-1G



CI-2G

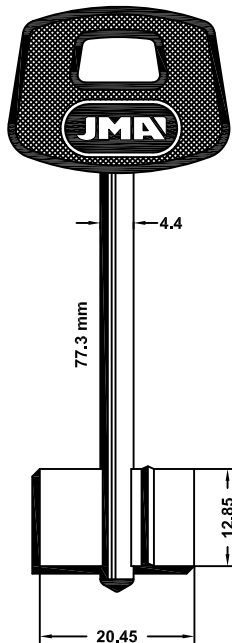

CI-1PG

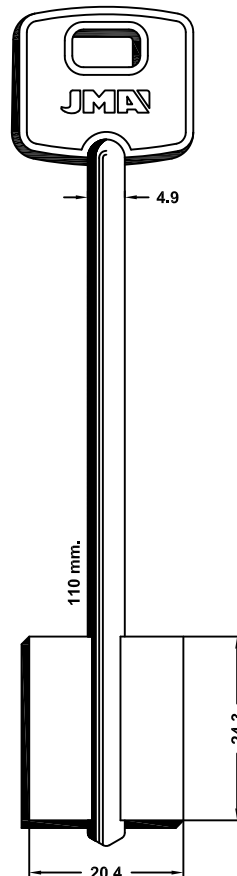

CI-3G



CI-4G

CISA

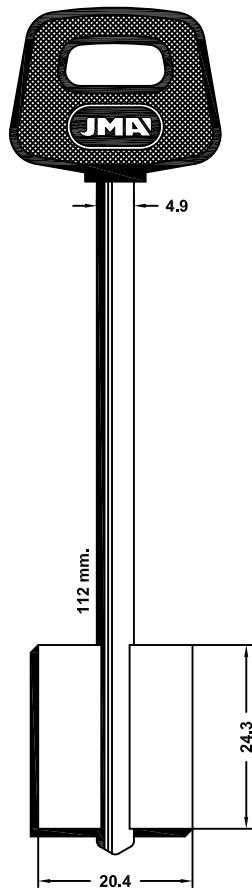

CI-3PG

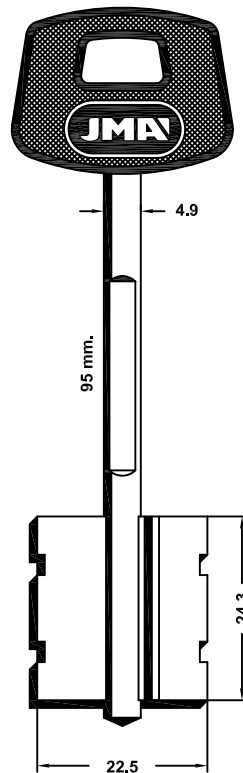

CI-5PG

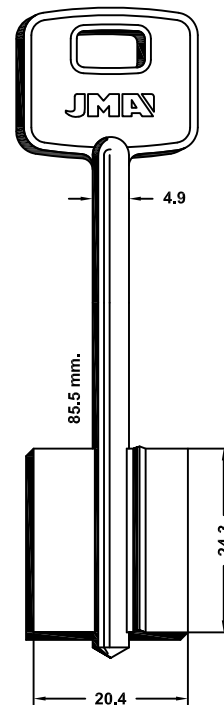

CI-6G



CI-10G





**CISA**

**PARA-FOR:**

CISA (I)

CLASS (RUS)

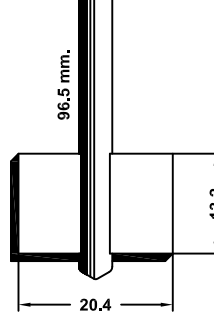
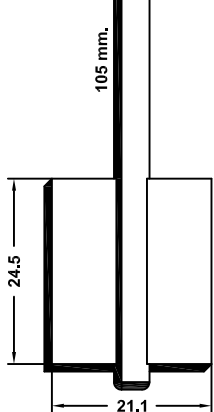
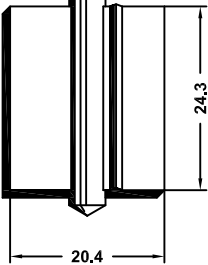
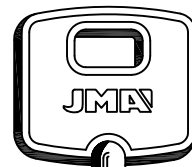
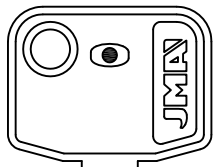

CI-6PG

CI-7TG

CI-8G



CI-12TG

**CISA**

**CLASS**

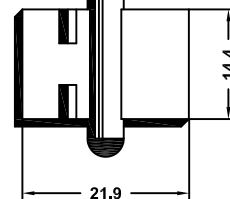
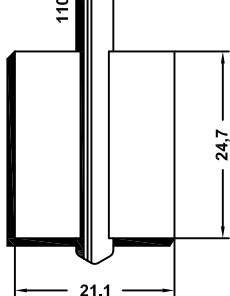
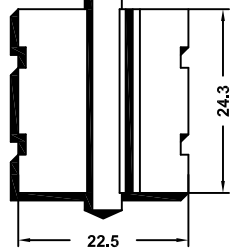
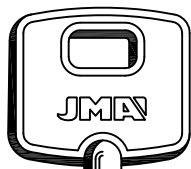

CI-9PG

CI-13G

CLA-3G



CI-14G



**PARA-FOR:**

CORNI (I)

CR (I)

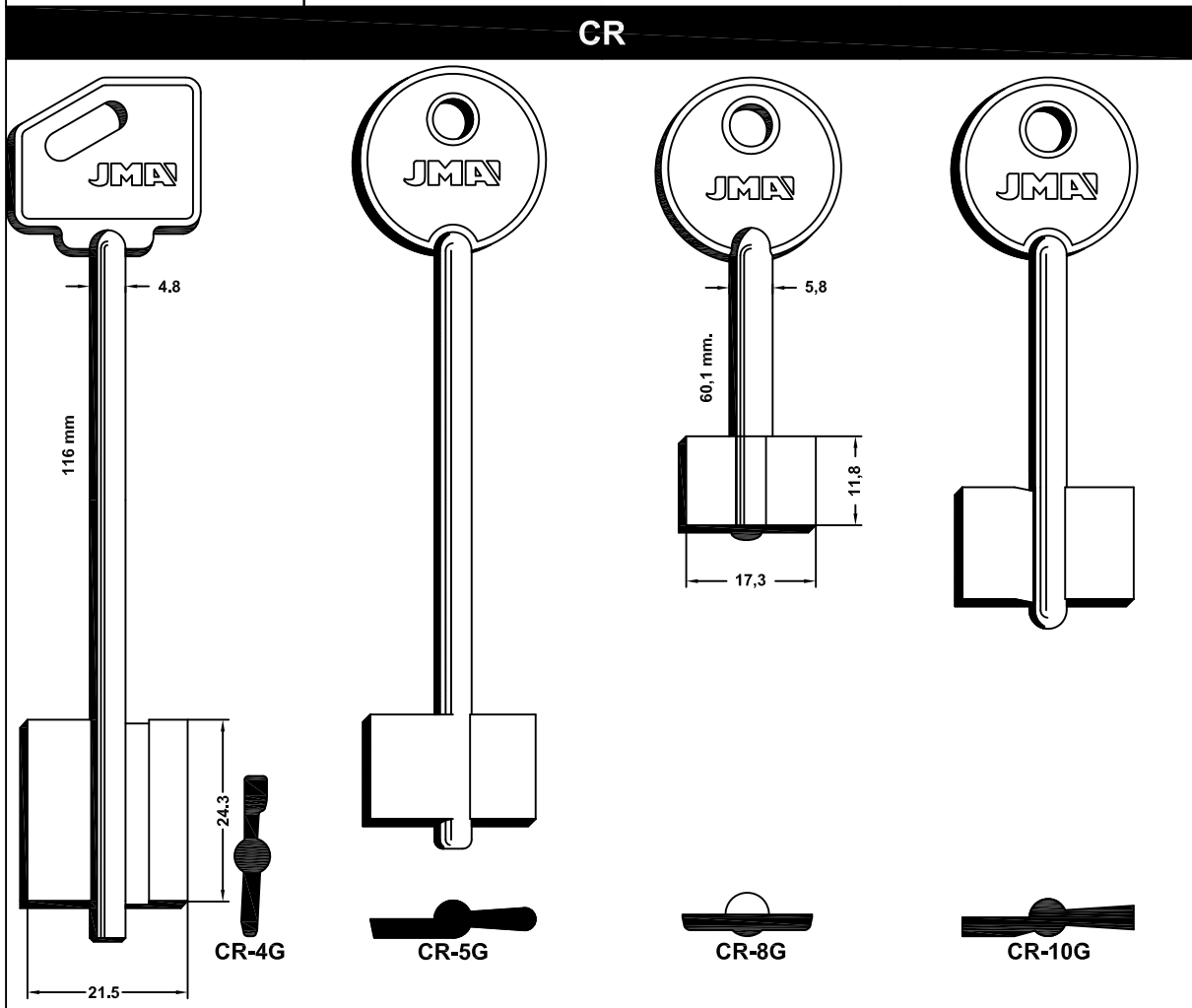
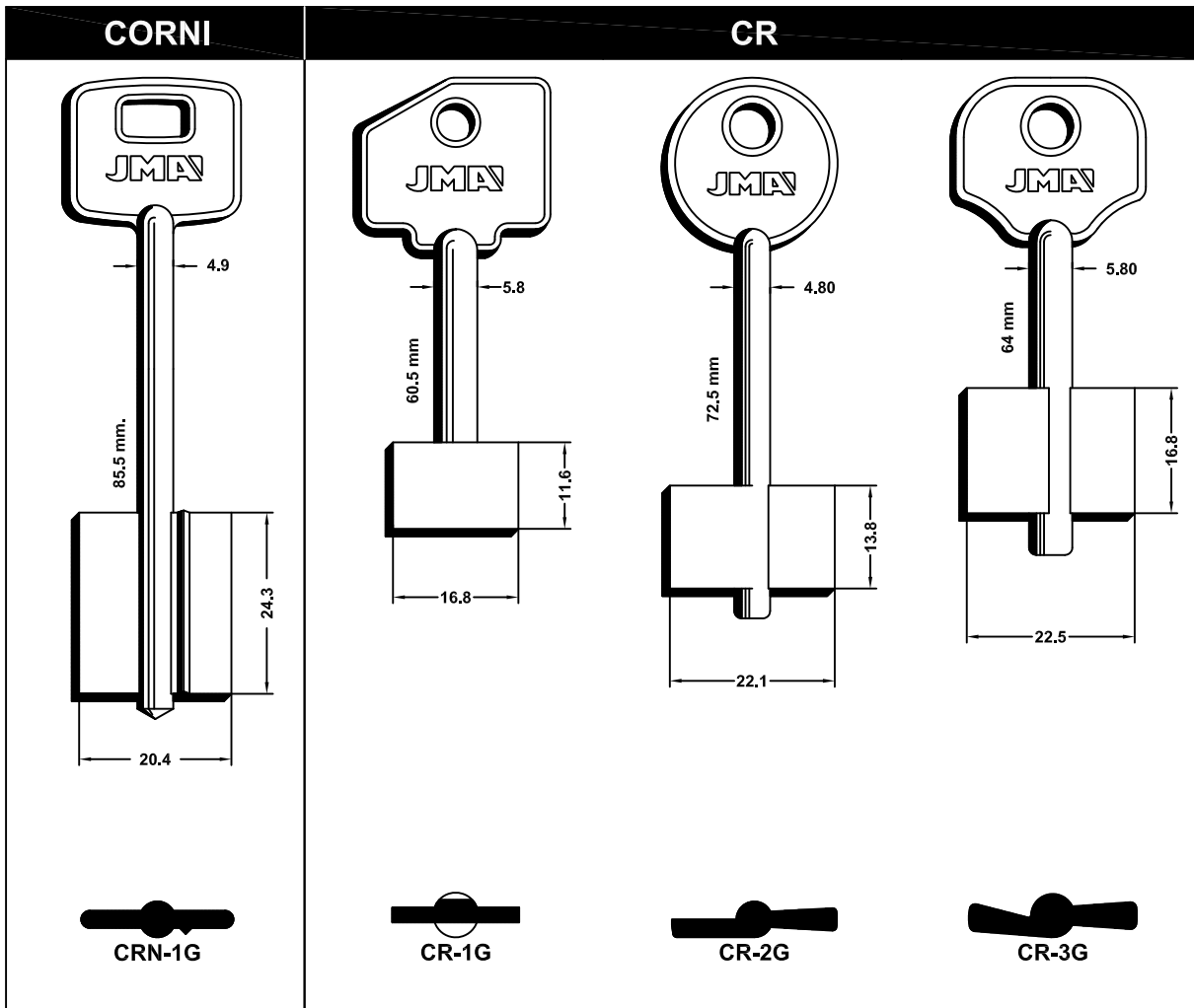

CR

PARA-FOR:

CR (I)

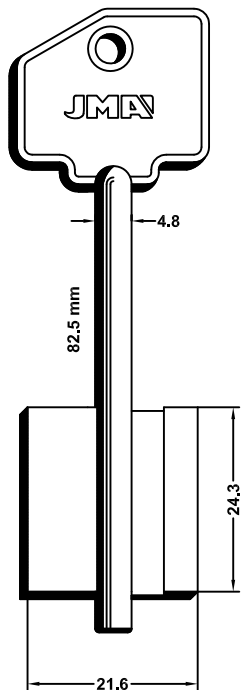

CR-11G

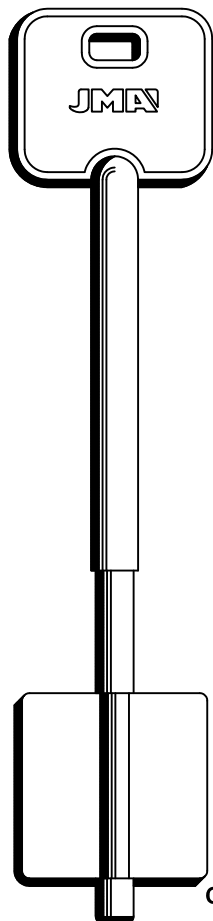

CR-12G

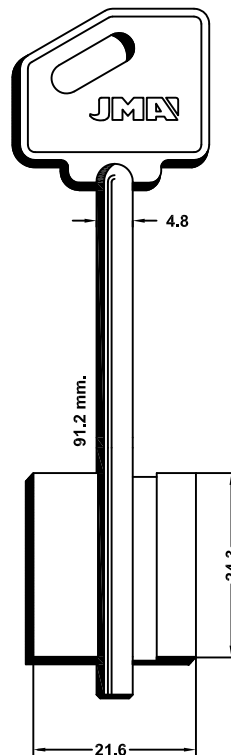

CR-14G

CR

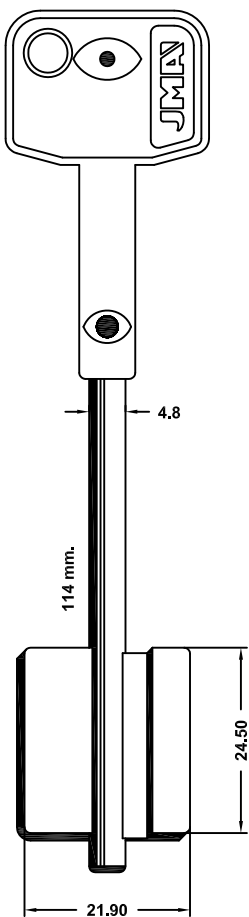

CR-17TG

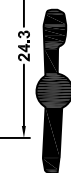
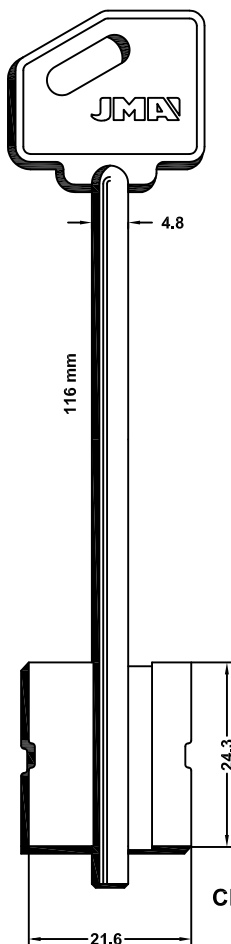

CR-18G

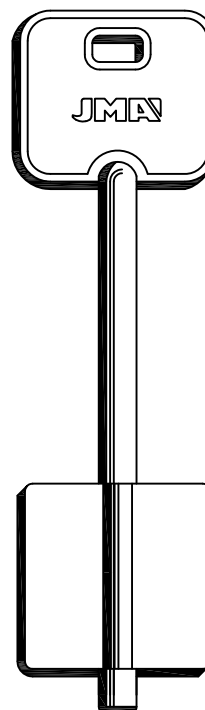

CR-19G



**PARA-FOR:**  
 DEKABA (BG)  
 DVERNIAK (RUS)

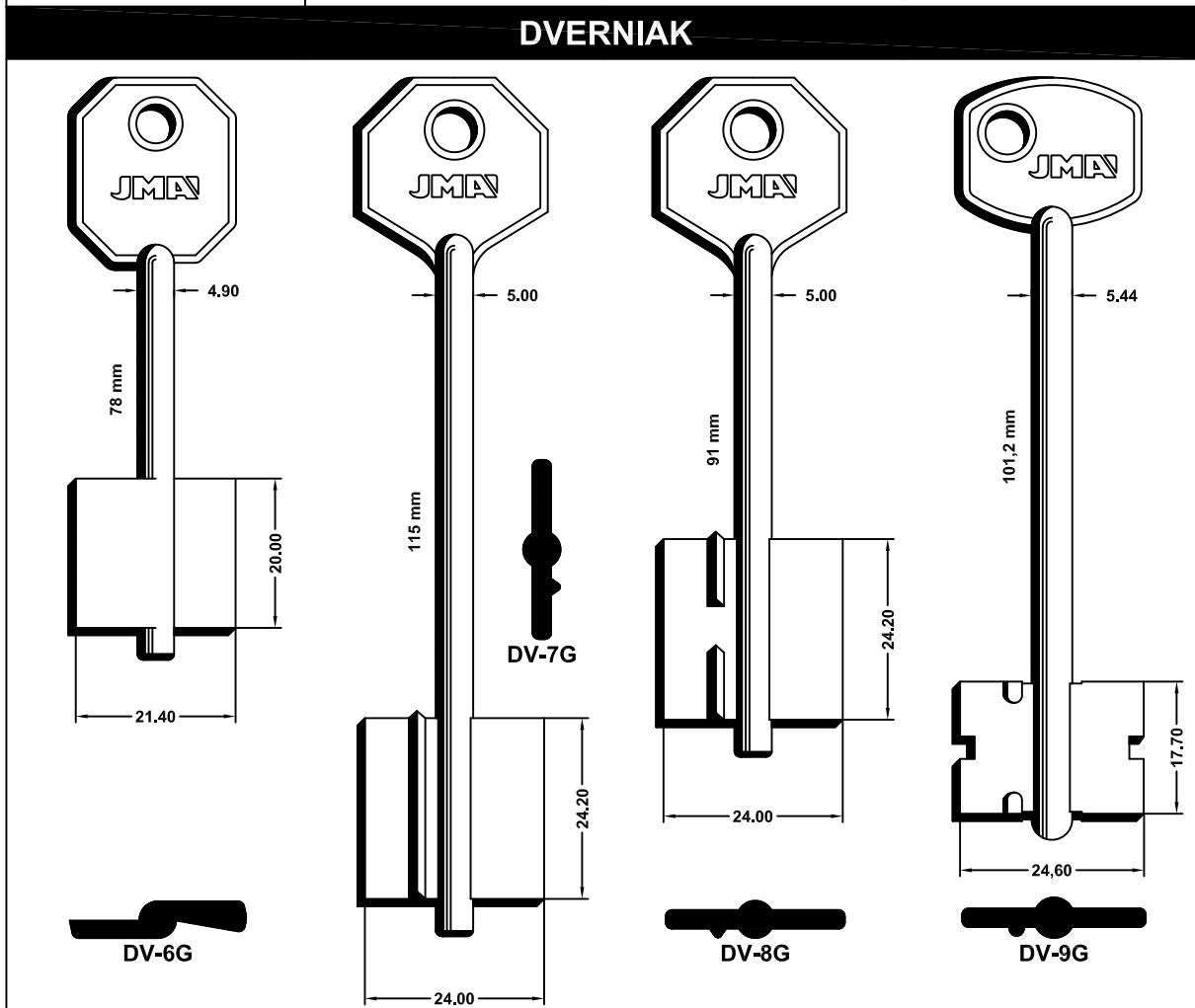
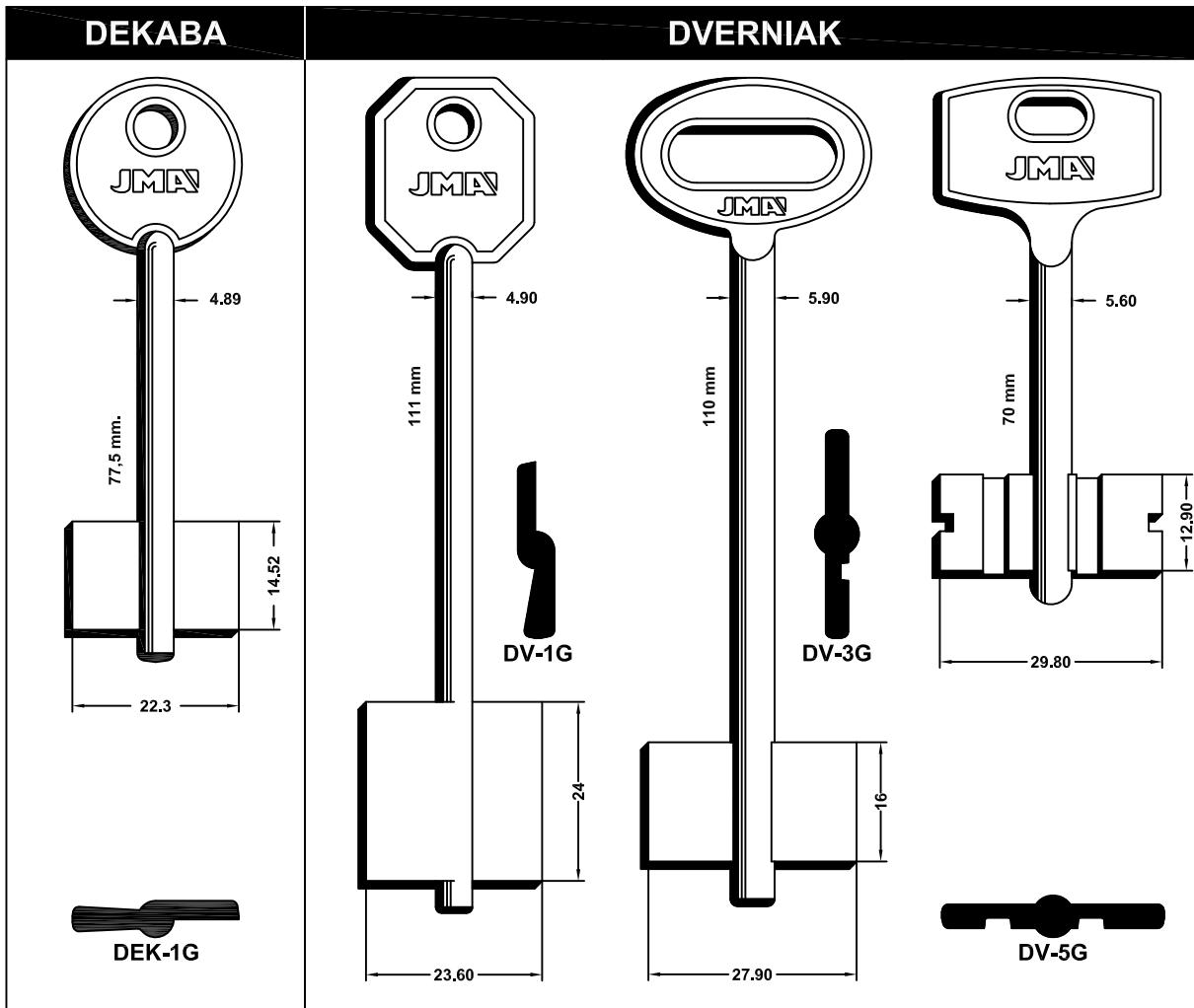

# DVERNIAK

**PARA-FOR:**  
 DVERNIAK (RUS)  
 ELBOR (RUS)

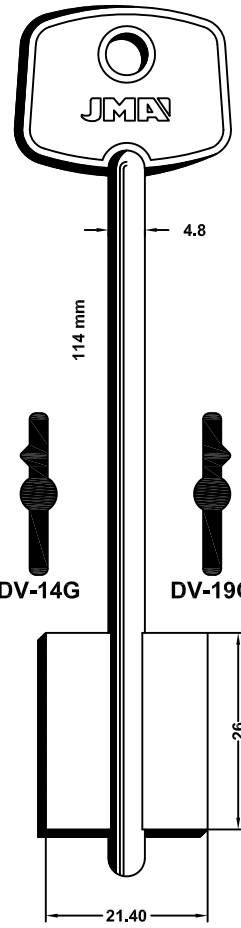
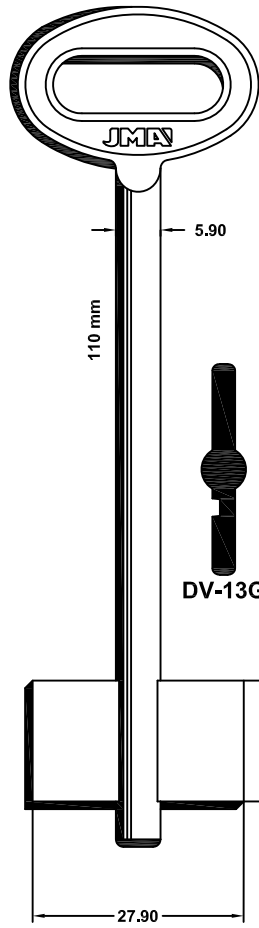
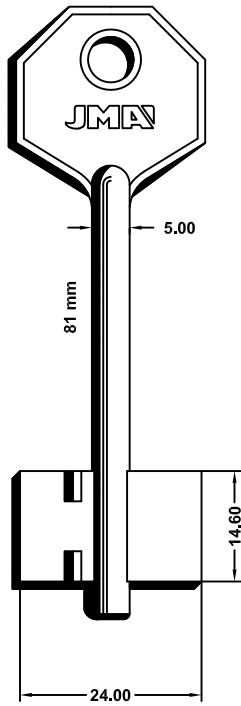
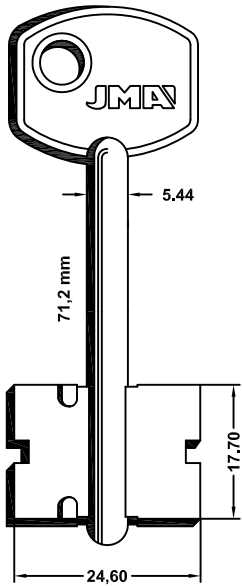

# DVERNIAK

# ELBOR

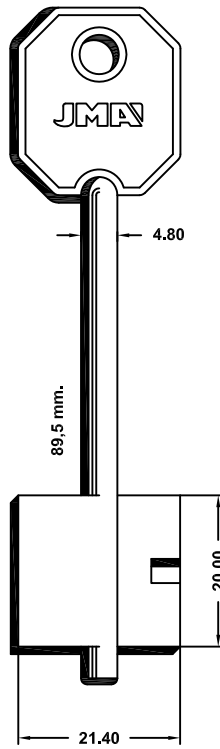
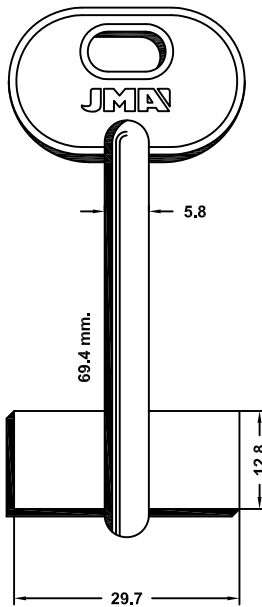
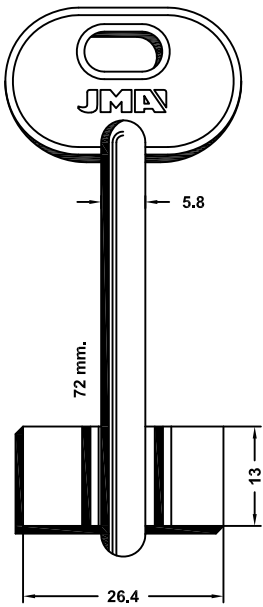

METTEM

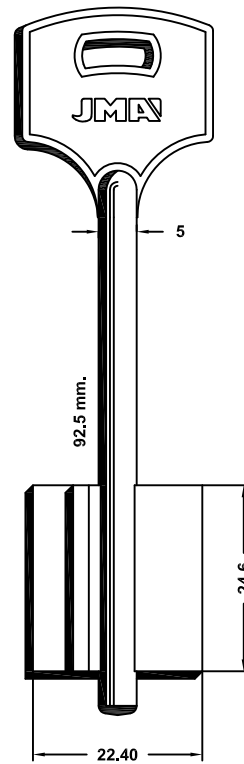

**PARA-FOR:**

ELZETT (H)  
 EREVAN (RUS)  
 ESETY (I)

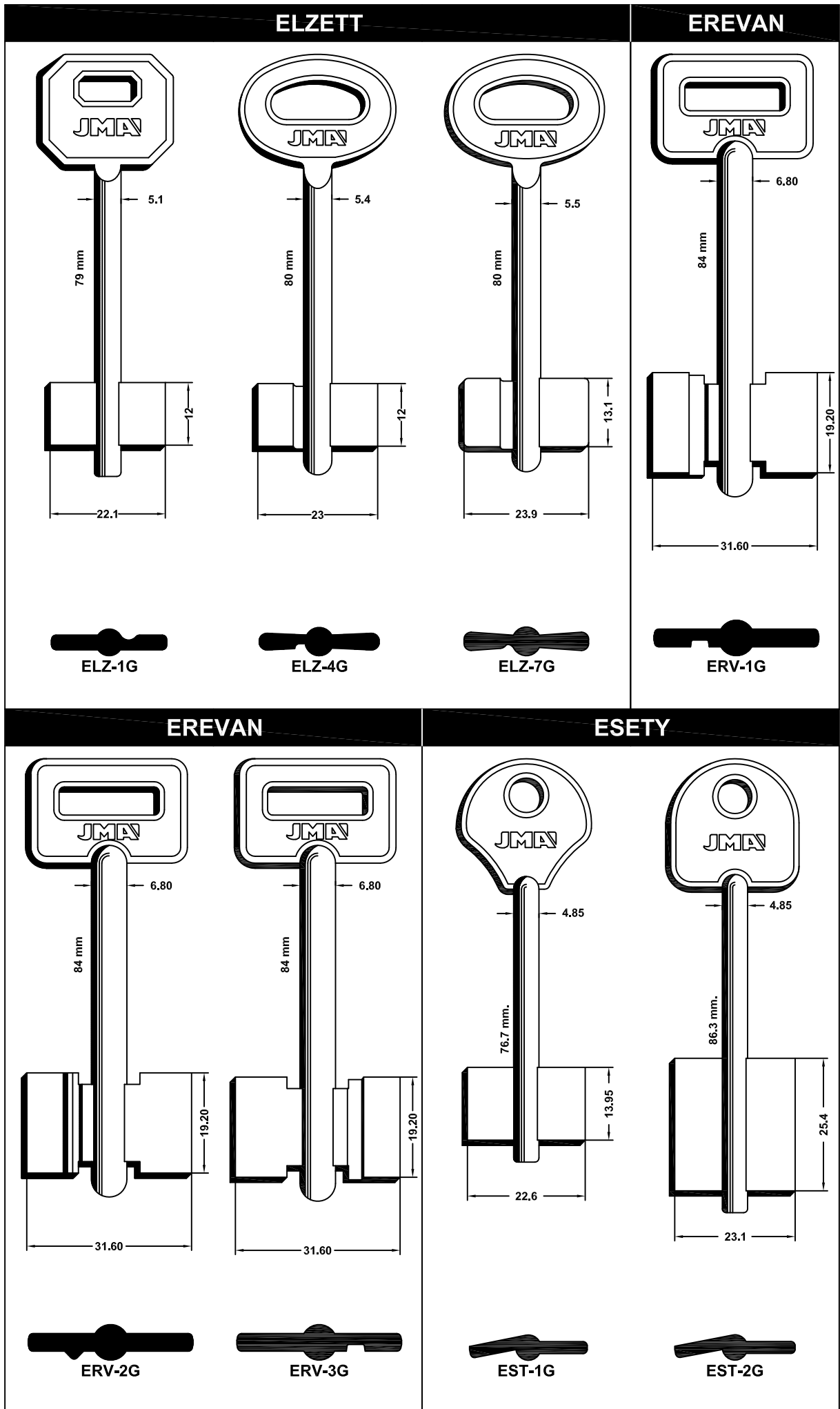

**ESETY**

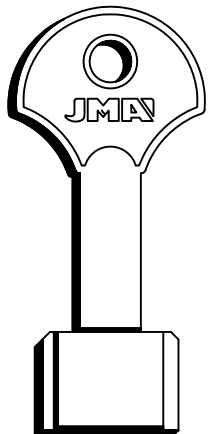

**EST-3G**

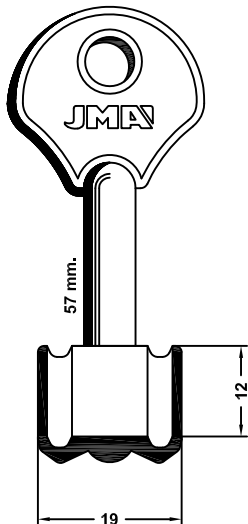

**EST-4G**

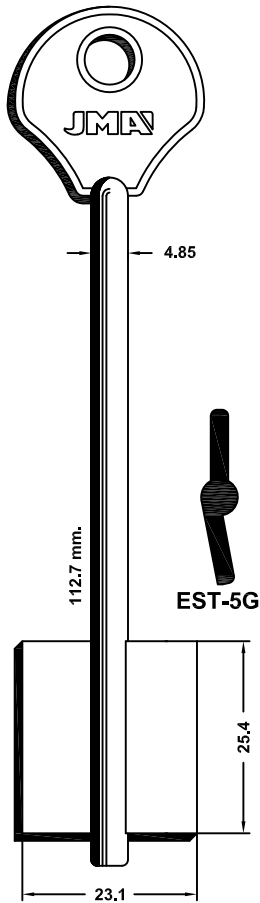

**EST-5G**

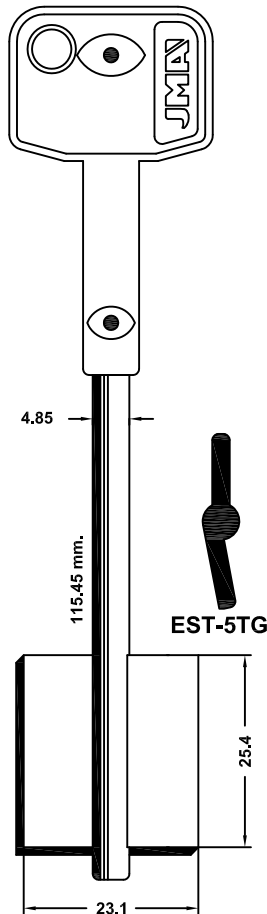

**EST-5TG**

**PARA-FOR:**

ESETY (I)

EUROTEMPLE (I)

**ESETY**

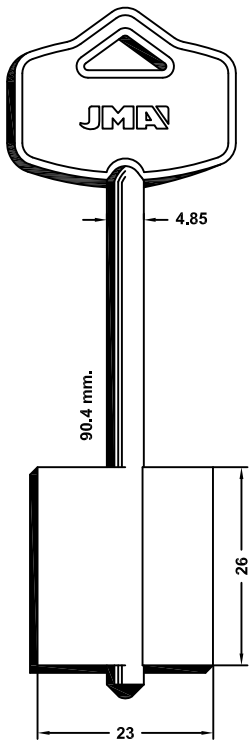

**EST-6G**

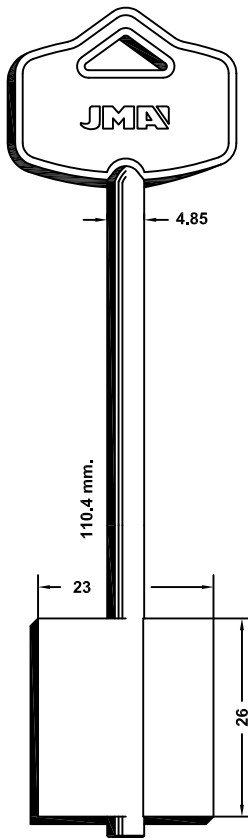

**EST-7G**

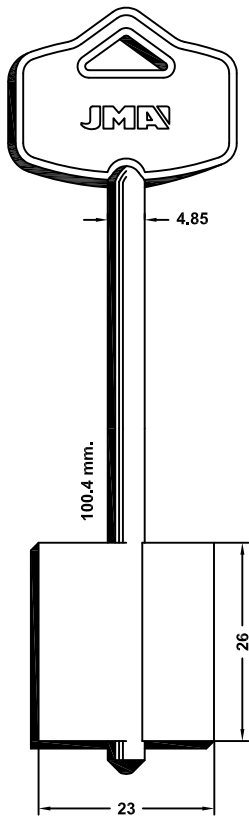

**EST-10G**

**EUROTEMPLE**

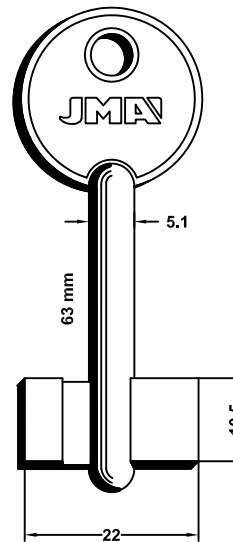

**EUT-1G**

SAG



**PARA-FOR:**  
 EUROTÉMPLE (I)  
 EZCURRA (E)

**EUROTÉMPLE**

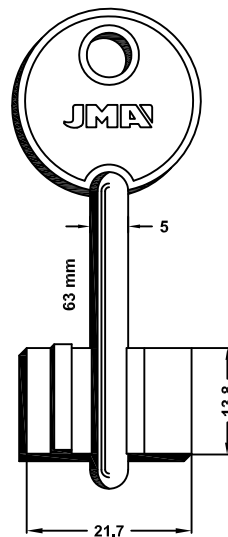
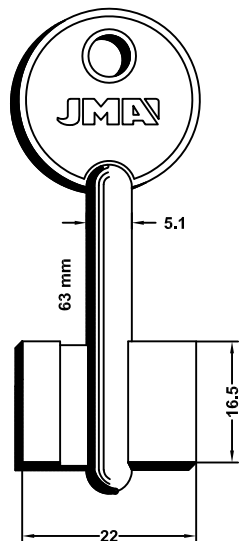

**EZCURRA**

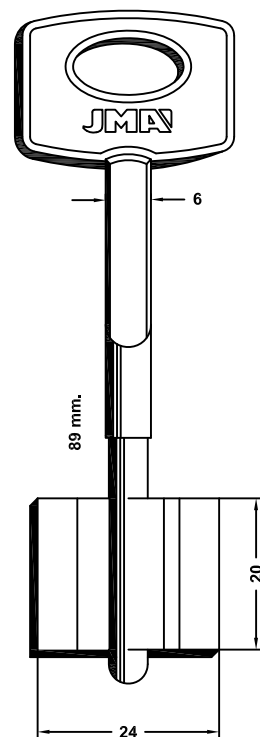
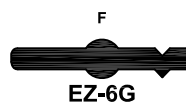
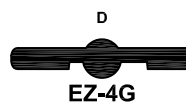
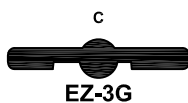
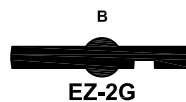
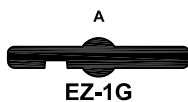
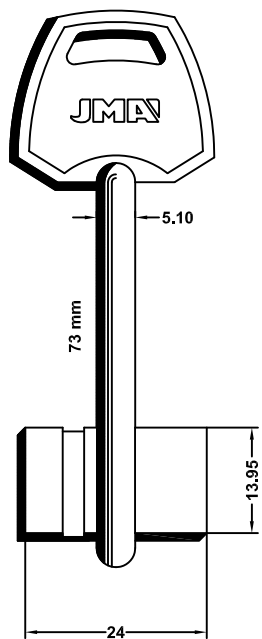



**EZCURRA**

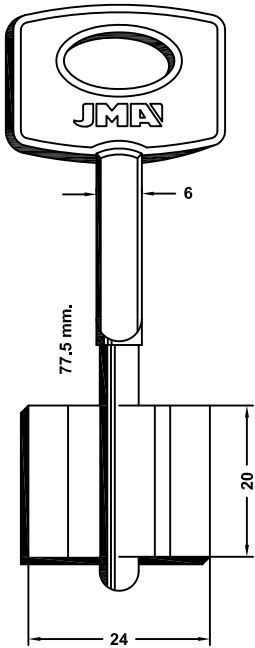

**FAC**

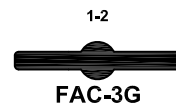
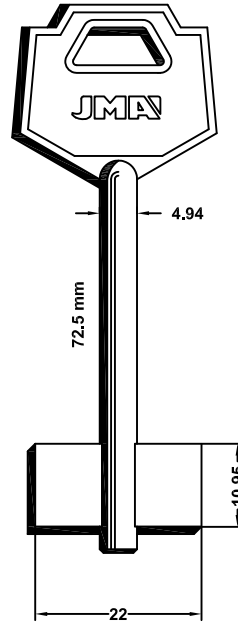
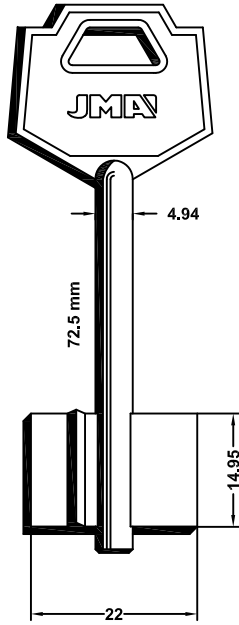
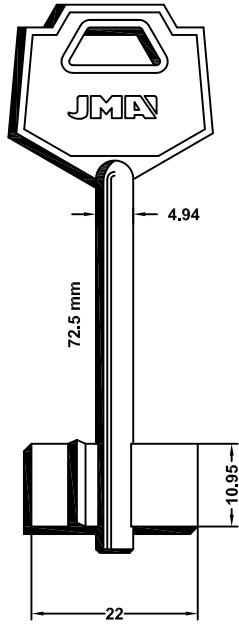

**PARA-FOR:**

EZCURRA (E)

FAC (E)

FEB (I)

FETIS (E)

**FAC**

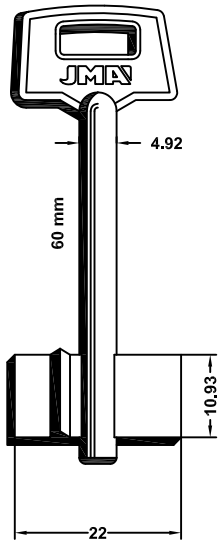

**FEB**

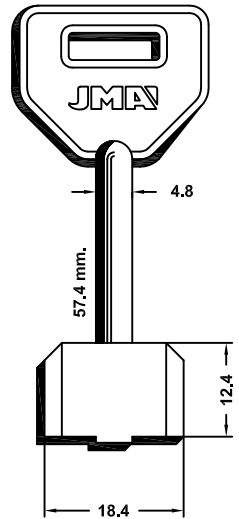
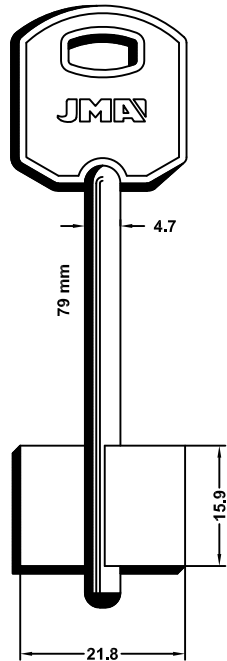

**FETIS**

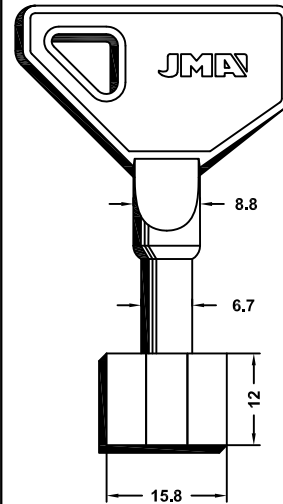

PARA-FOR:

FIAM (I)

FIAM

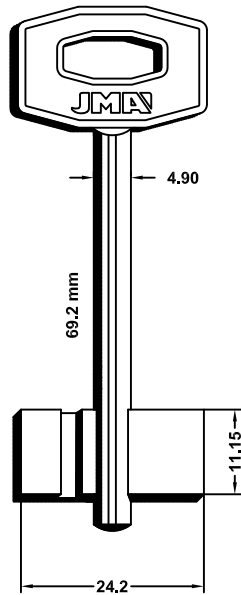

FM-1G

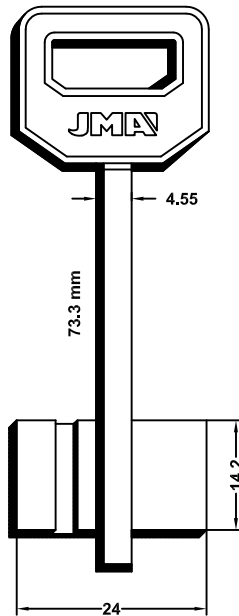

FM-2G

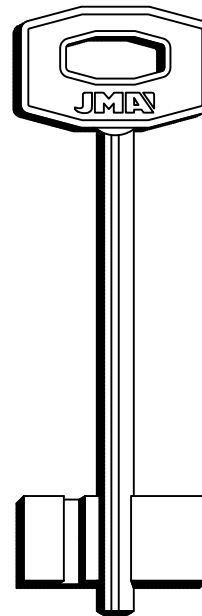

FM-3G

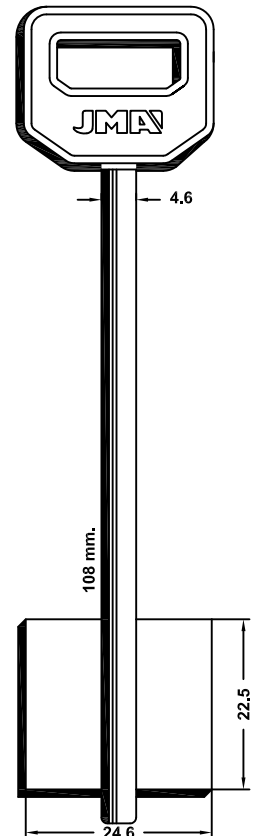

FM-4G

FIAM

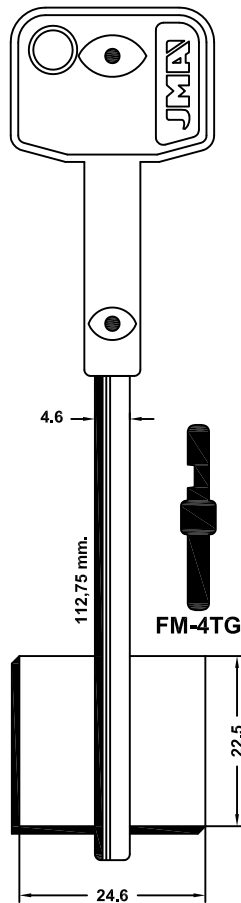

FM-4TG

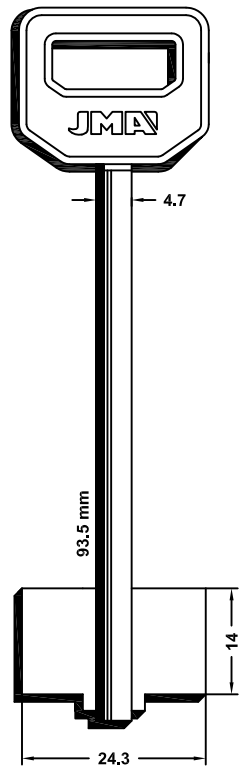

FM-5G

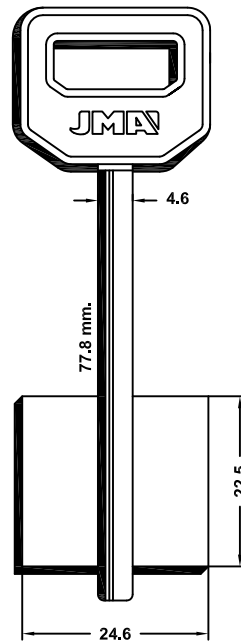

FM-6G

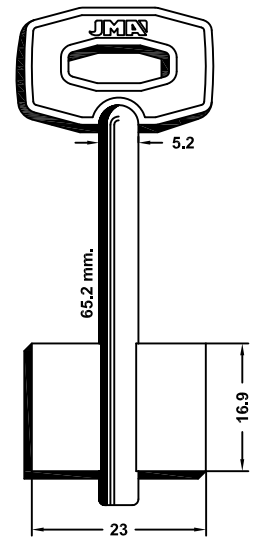

FM-7G



FIAM

PARA-FOR:

FIAM (I)

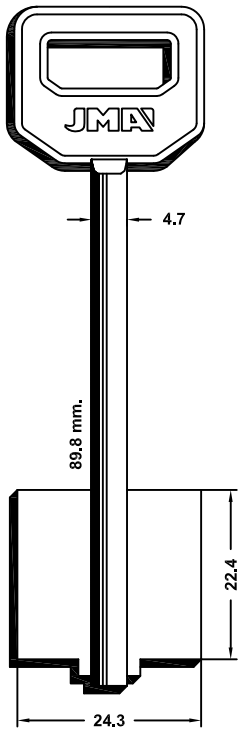

FM-8G

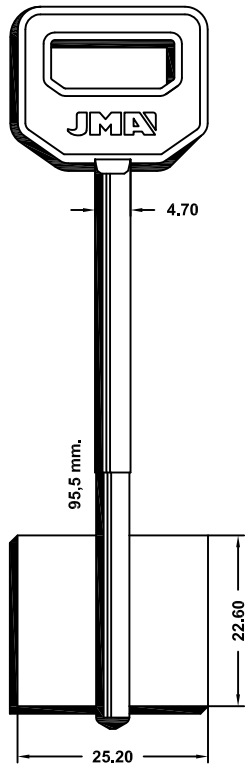

FM-13G

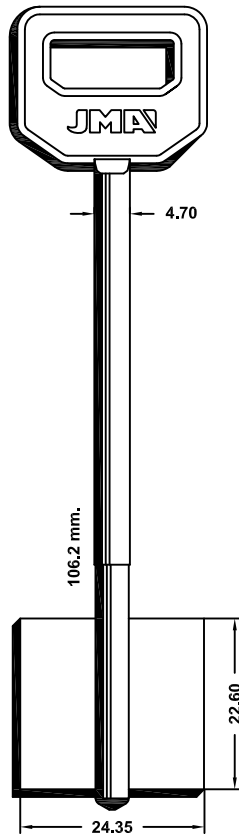

FM-14G

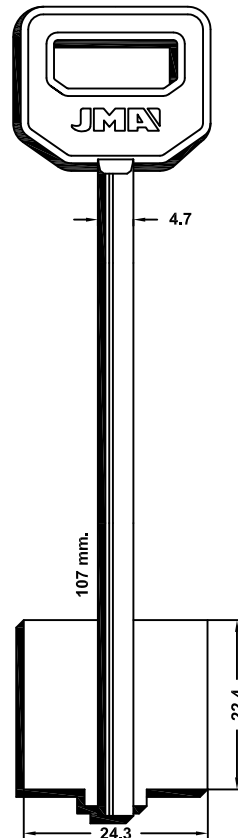

FM-15G

FIAM

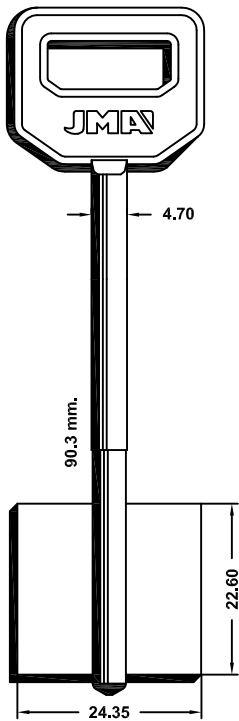

FM-16G

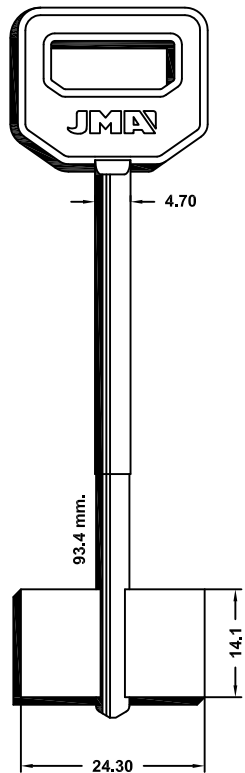

FM-17G

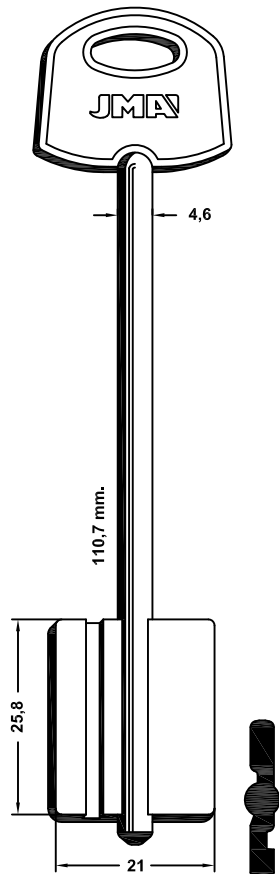

FM-20G

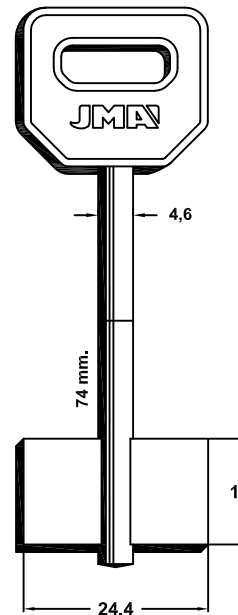

FM-21G

ISEO



**PARA-FOR:**

- FICHET (F)
- GARDIAN (RUS)
- GIMAST (I)
- GIPIS (I)
- GMG (I)

	FICHET	GARDIAN	GIMAST	
	<p>FIC-200</p>	<p>GARD-1G</p>	<p>GIM-1TG</p>	
	GIPIS		GMG	
	<p>GPS-1G</p>	<p>GPS-2G</p>	<p>GMG-1G</p>	<p>GMG-2G</p>



**IDM**

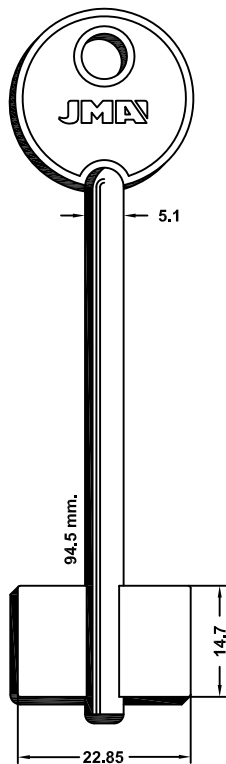

**IDM-1G**

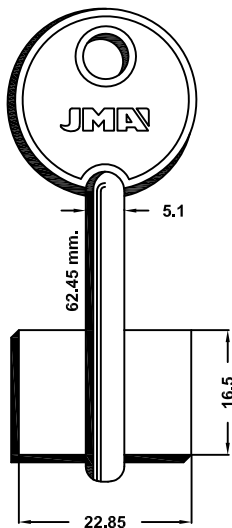

**IDM-2G**

SAG

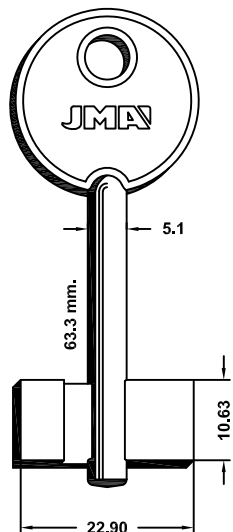

**IDM-3G**

SAG

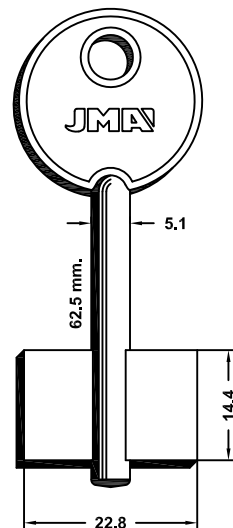

**IDM-4G**

**PARA-FOR:**

IDM (I)

ISEO (I)

**IDM**

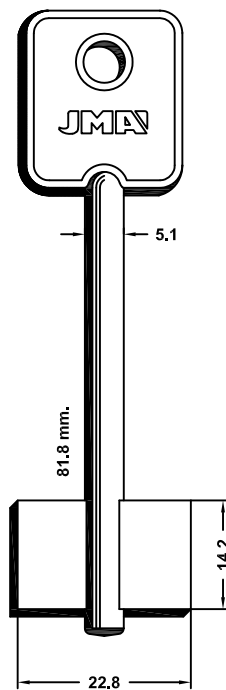

**IDM-5G**

FACEF-DOMUS

**ISEO**

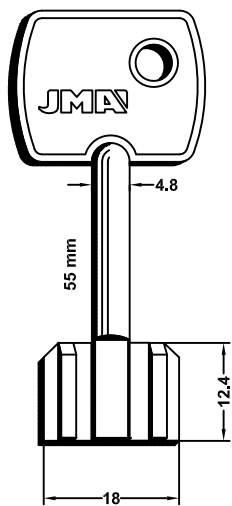

**IS-1G**

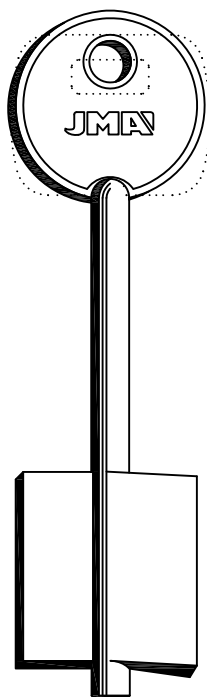

**IS-2G**

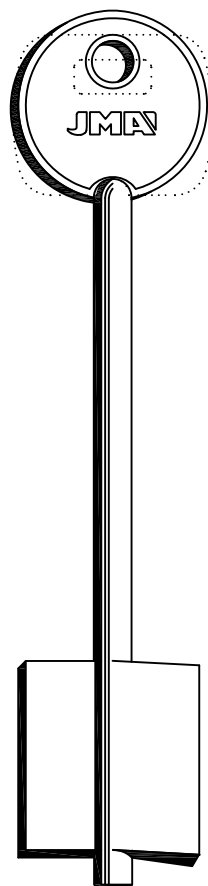

**IS-3G**



**PARA-FOR:**

ISEO (I)

ITAL (I)

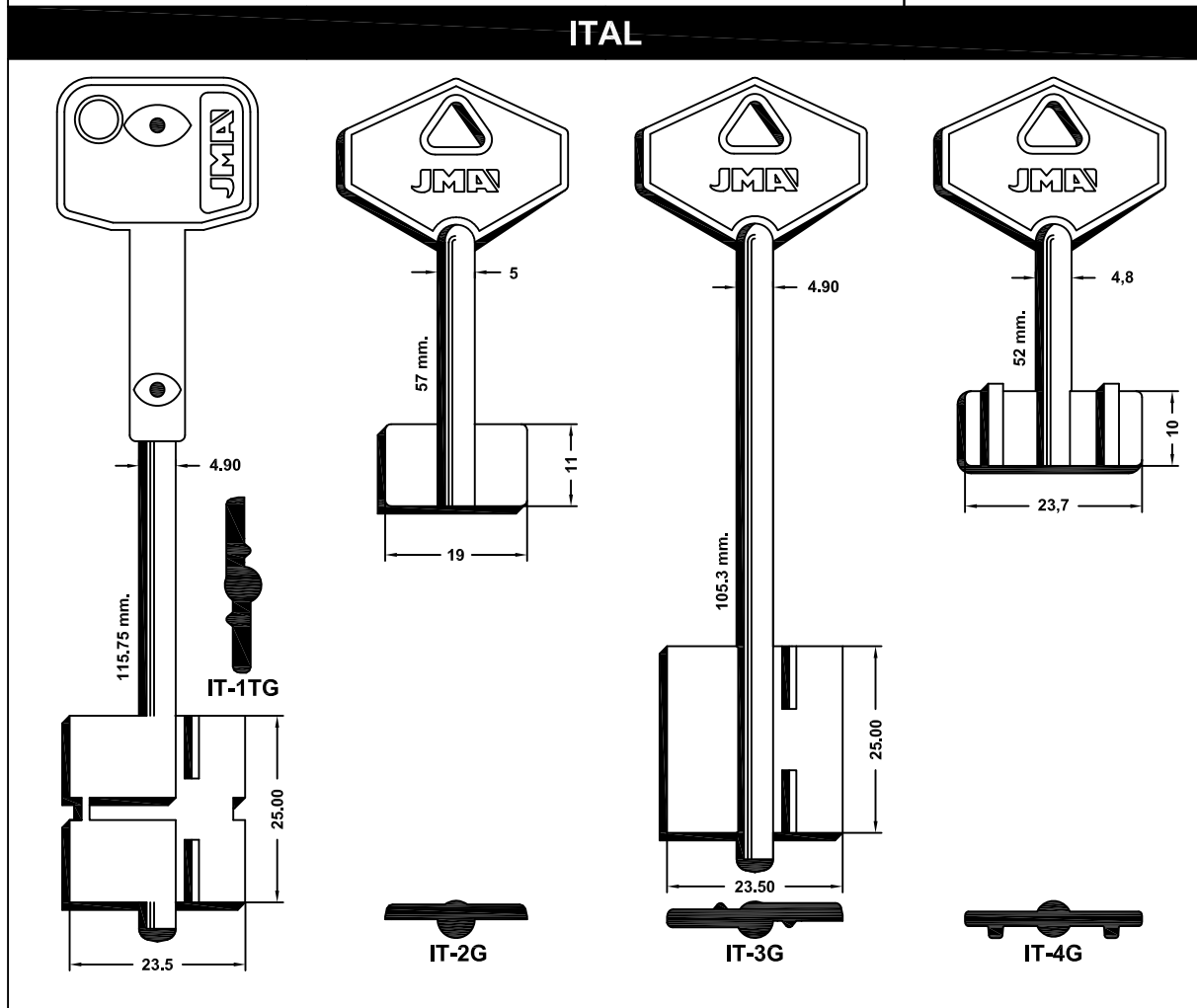
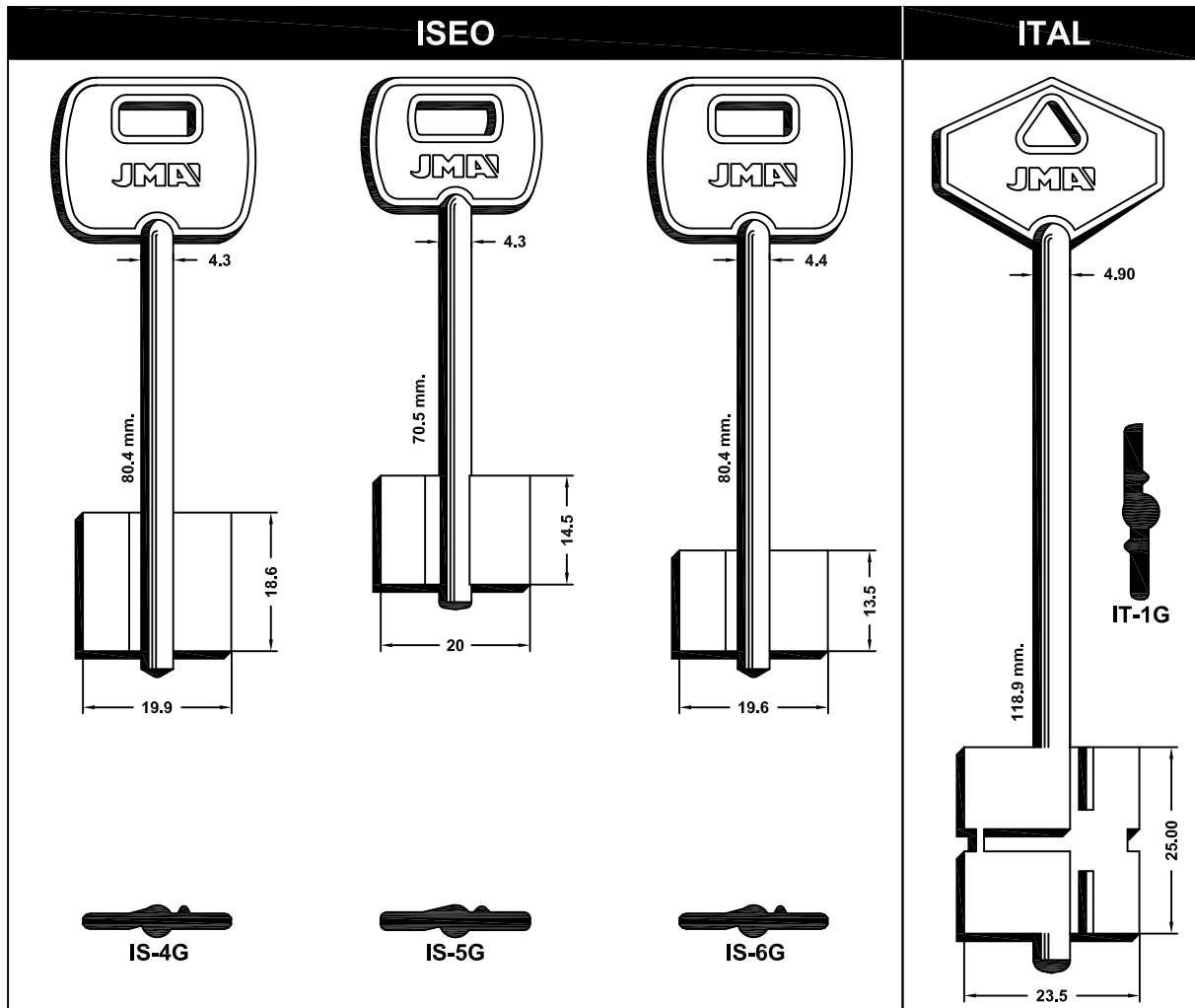

# JUWEL

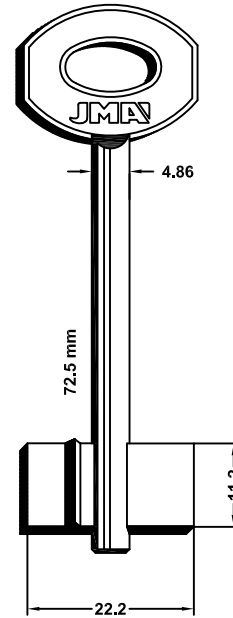
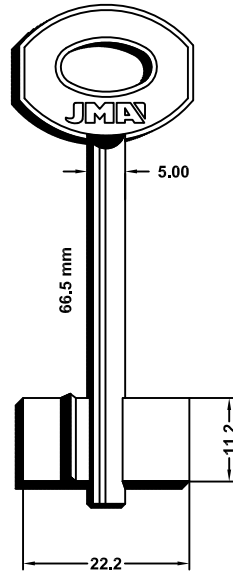
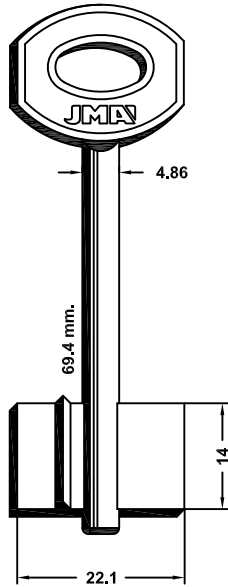
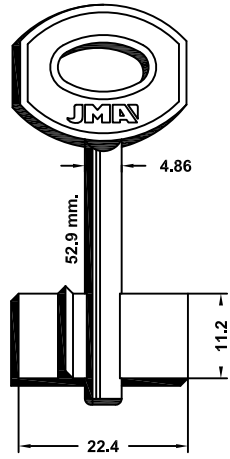

**JW-20G**

BURG-WACHTER



**JW-30G**

BURG-WACHTER



**JW-40G**

BURG-WACHTER



**JW-45G**

BURG-WACHTER

# JUWEL

# KALE

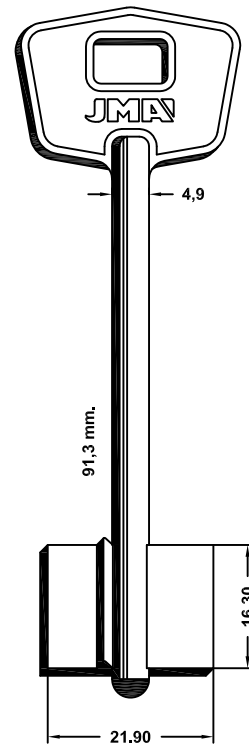
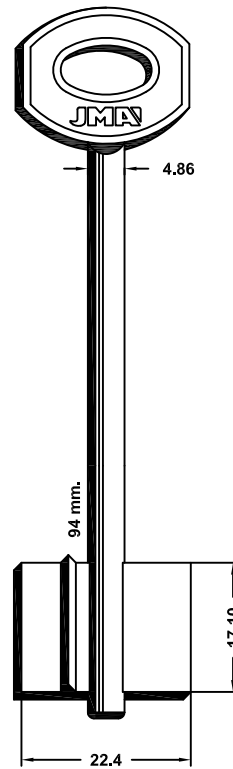
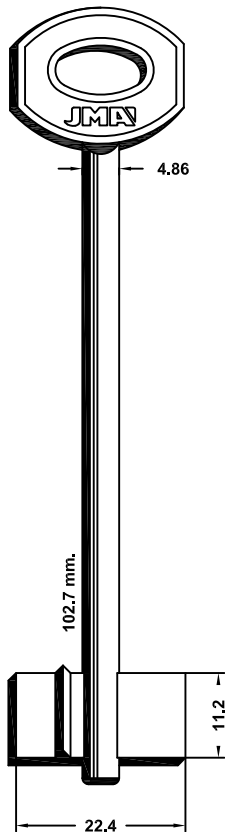
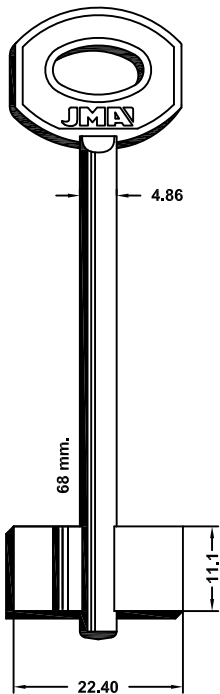

**JW-50G**



**JW-70G**

BURG-WACHTER



**JW-90G**



**KAE-1G**

# PARA-FOR:

JUWEL (I)

KALE (TR)



**PARA-FOR:**

KASSEL (I)

KERBEROS (RUS)

**KASSEL**

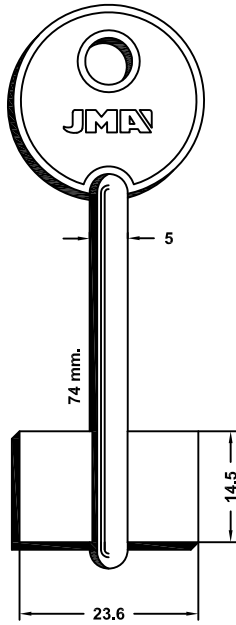

**KAS-1G**

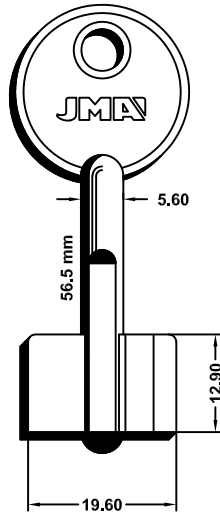

**KAS-2G**

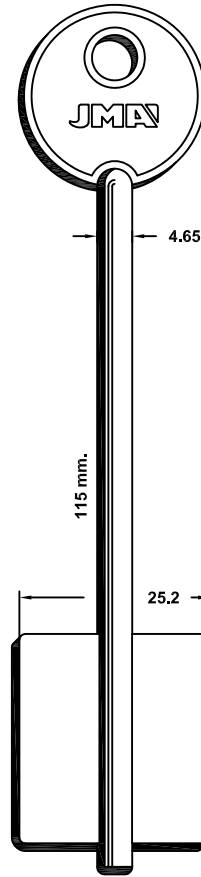

**KAS-4G**

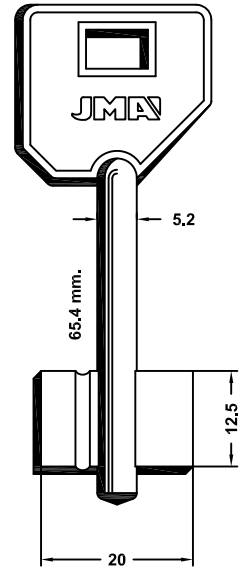

**KAS-6G**

**KERBEROS**

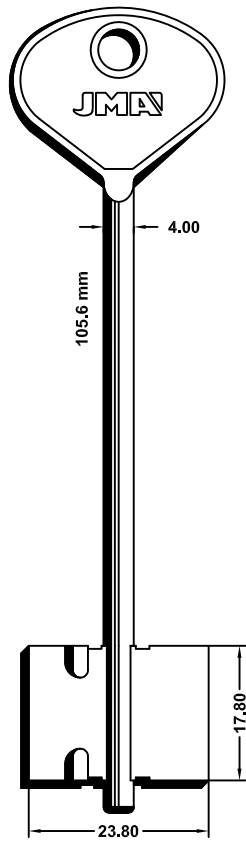

**CER-1G**

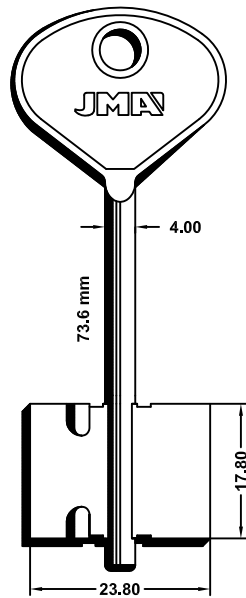

**CER-2G**

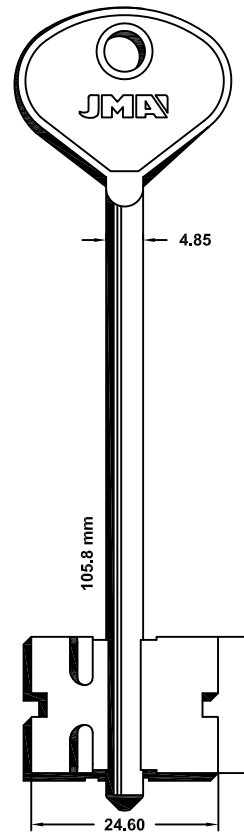

**CER-3G**

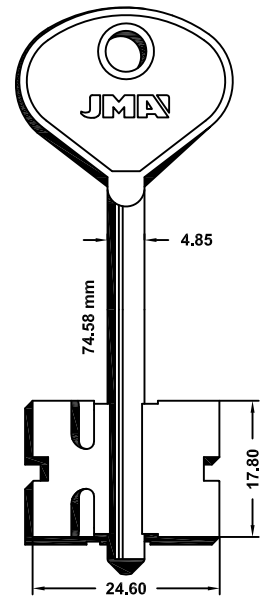

**CER-4G**



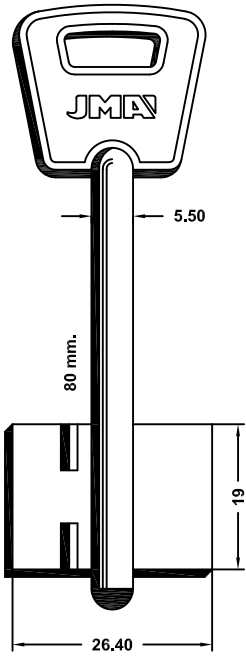
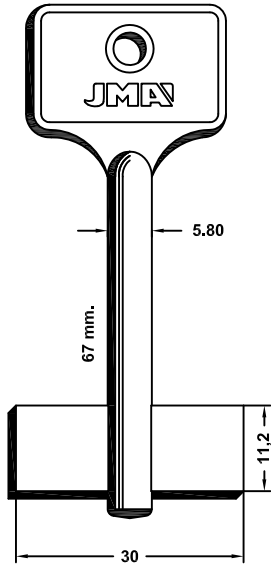
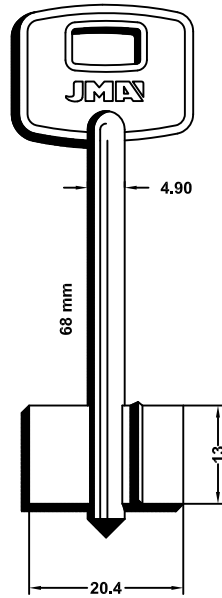
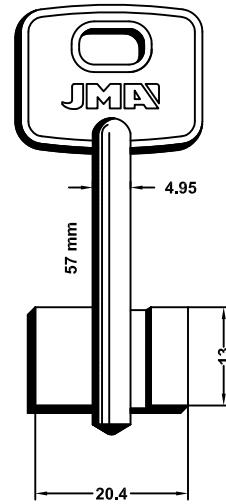

**KREPISH****KRP-1G****KURZEME****KUR-1G****LINCE****LIN-2G****LIN-3G****PARA-FOR:**

KREPISH (RUS)

KURZEME (RUS)

LINCE (E)

MCM (E)

METAL (BG)

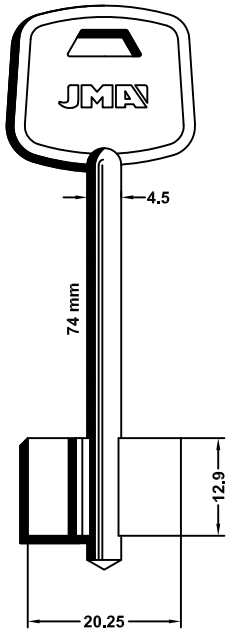
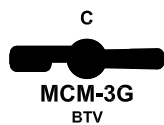
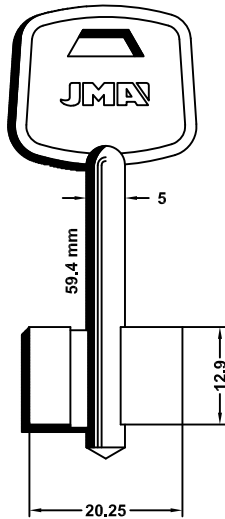
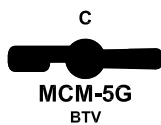
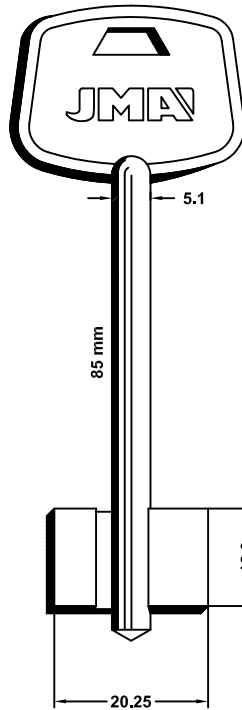
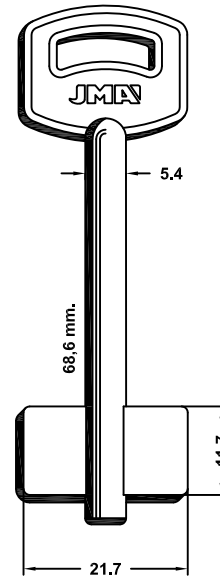
**MCM****MCM-2G****MCM-3G  
BTV****MCM-5G  
BTV****METAL****MTL-1G**

**PARA-FOR:**

METAL (BG)

MOIA (I)

MOTTURA (I)

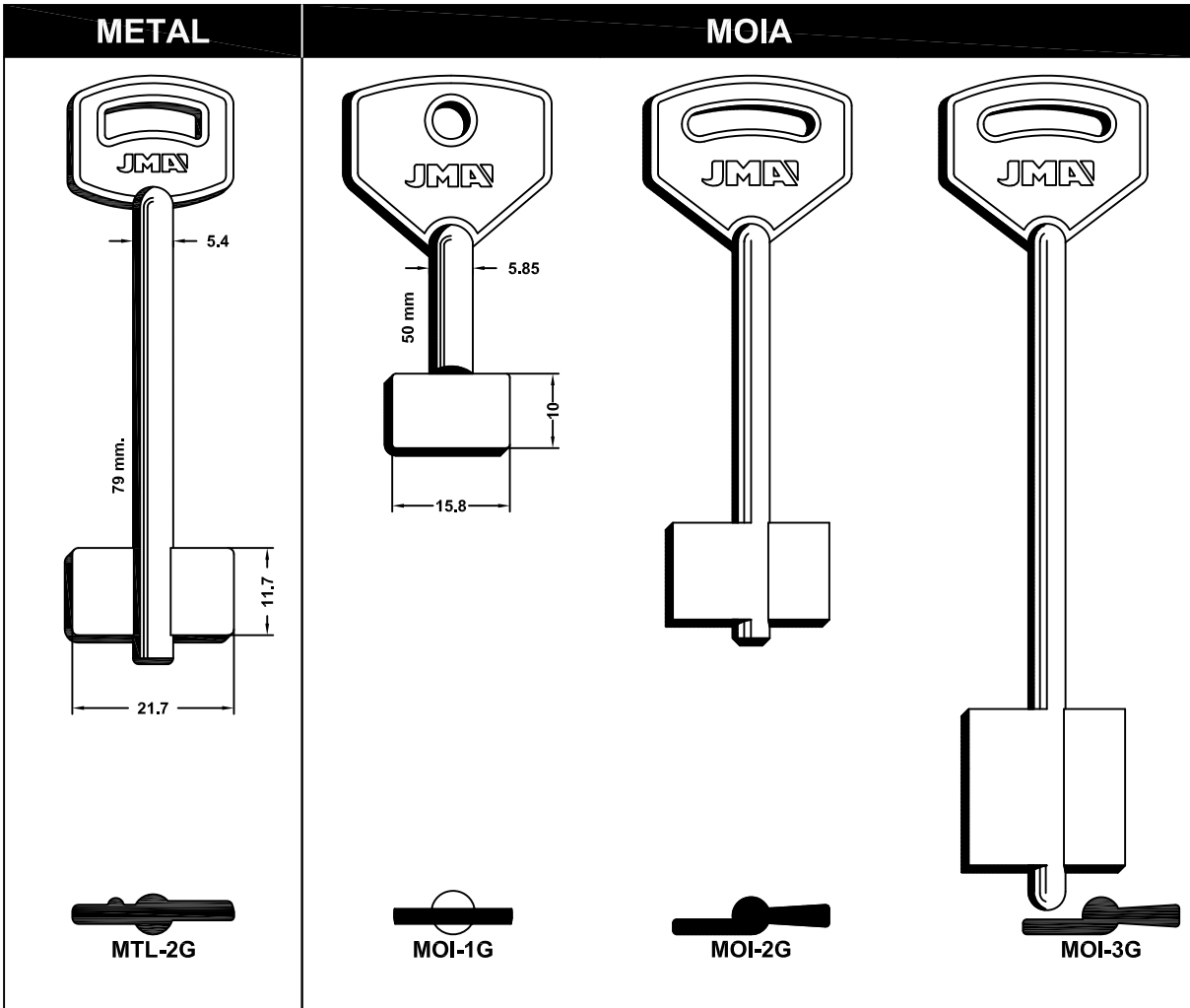

**MOTTURA**

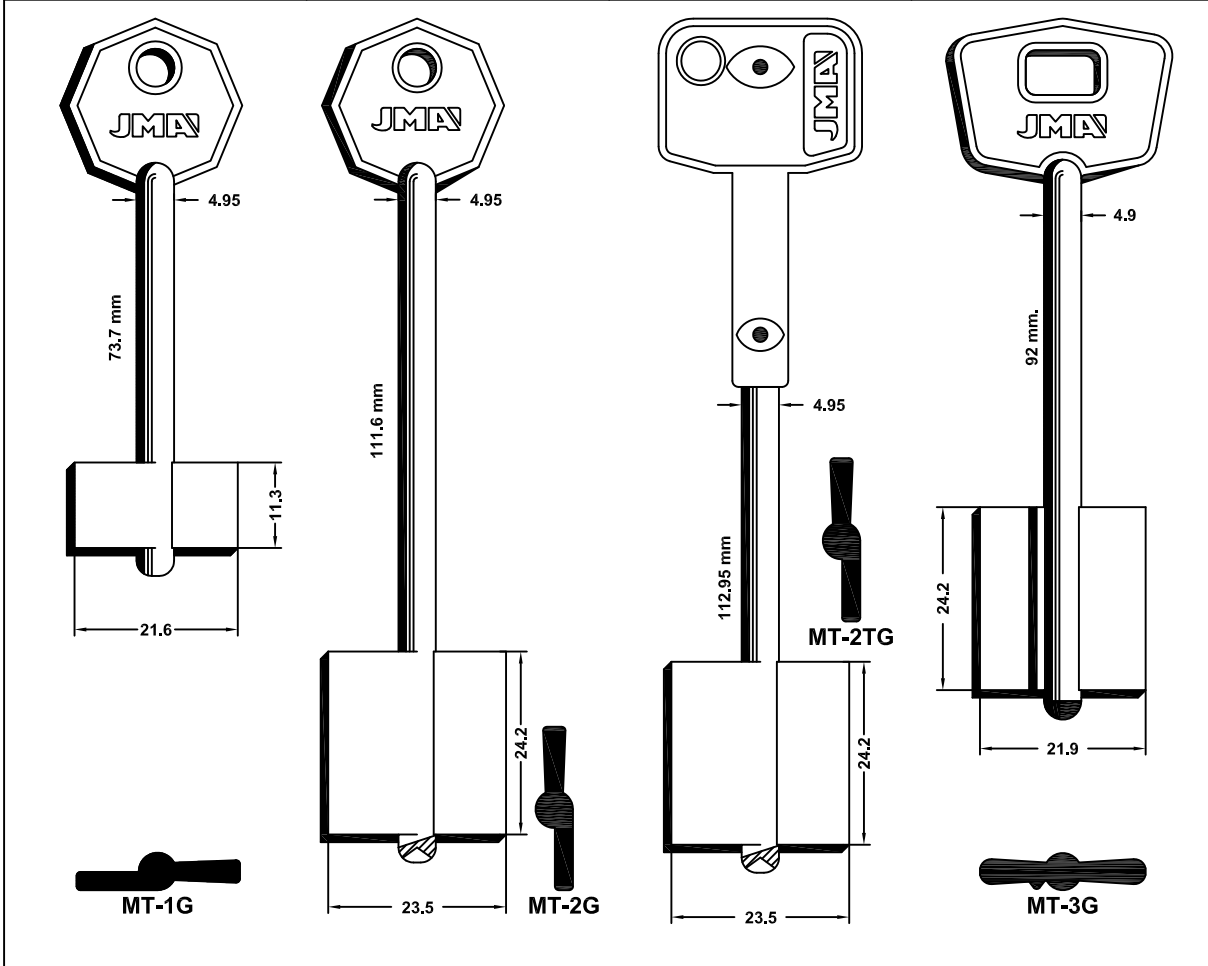

## MOTTURA

PARA-FOR:  
MOTTURA (I)

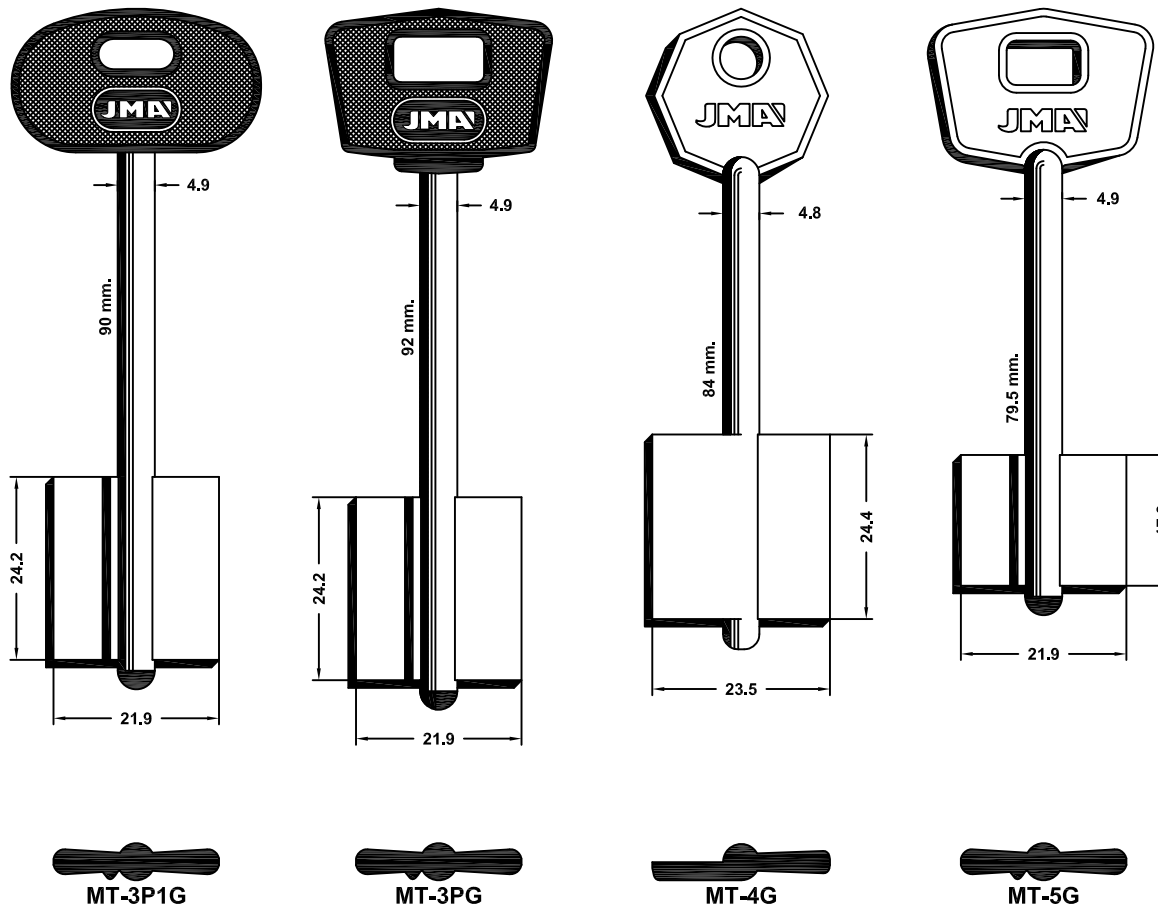

## MOTTURA

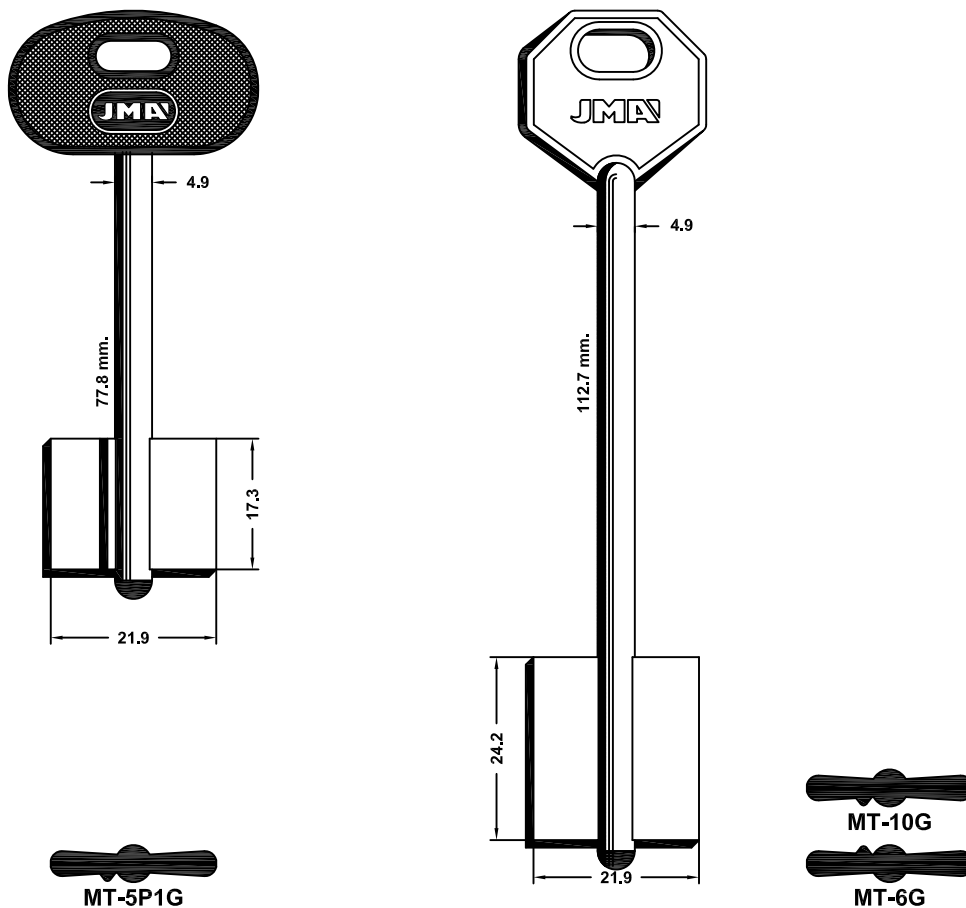

**PARA-FOR:**

MOTTURA (I)

**MOTTURA**

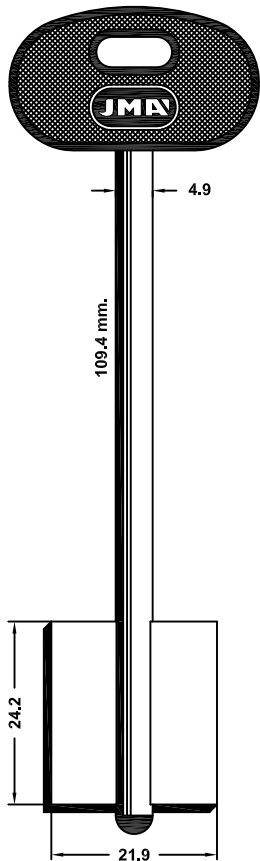

MT-10P1G  
MT-6P1G

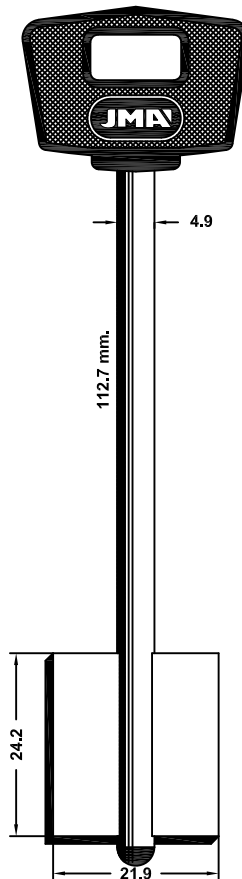

MT-10PG  
MT-6PG

**MOTTURA**

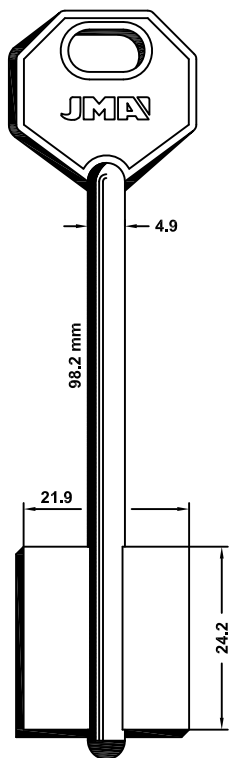

MT-9G  
MT-8G

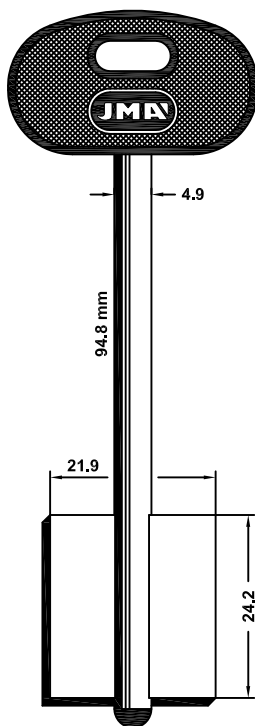

MT-9P1G  
MT-8P1G

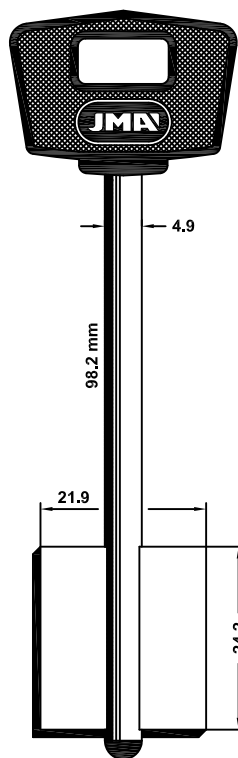

MT-9PG  
MT-8PG

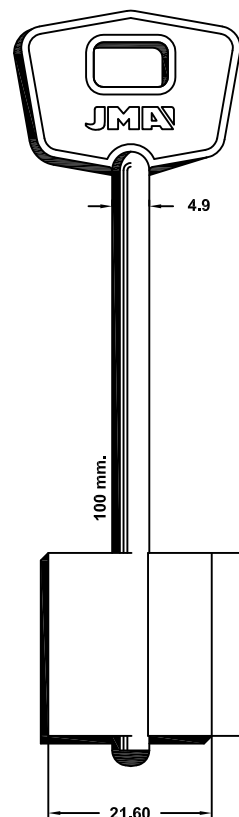

MT-11G



# MOTTURA

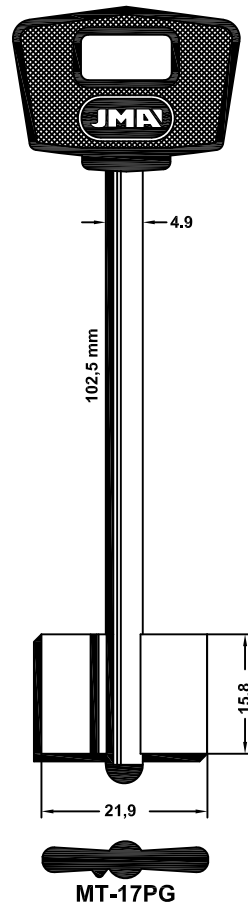
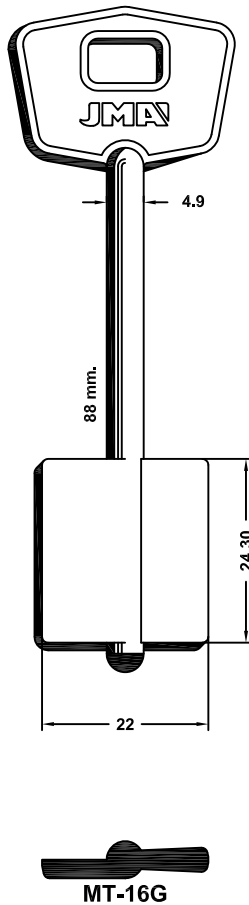
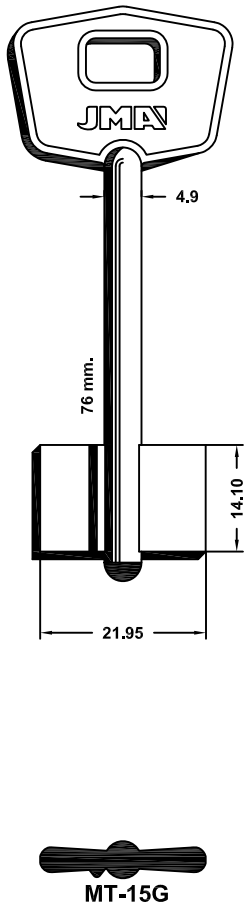
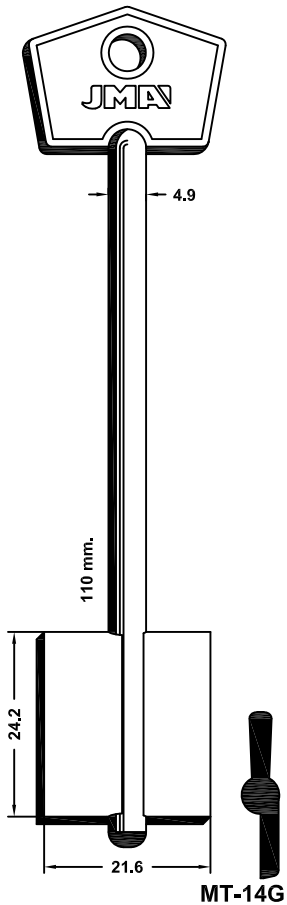

# PARA-FOR:

MOTTURA (I)

OMEC (I)

ORENGO (E)

PATRONE (I)

## MOTTURA

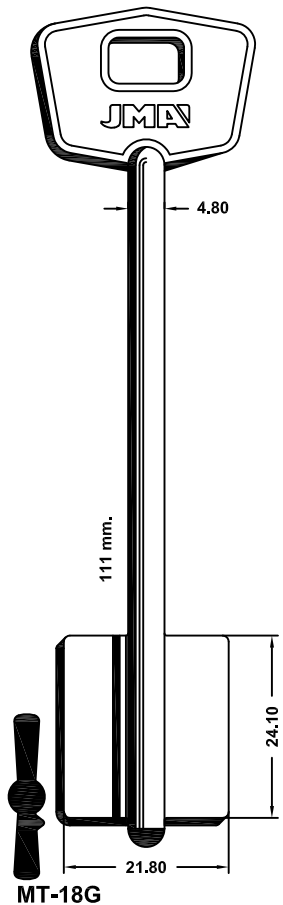

## OMEC

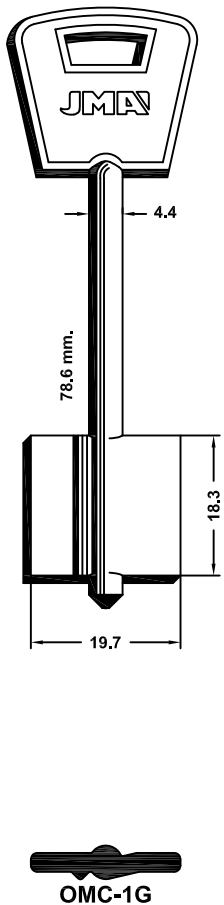

## ORENGO

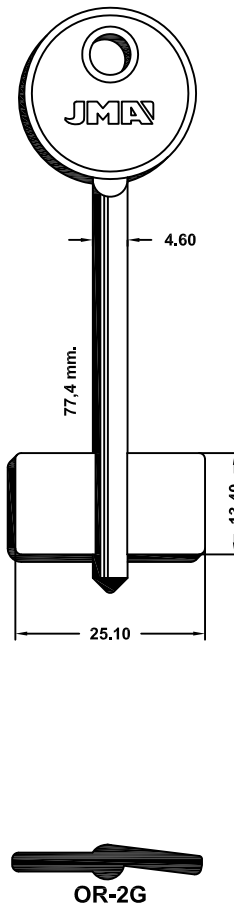

## PATRONE

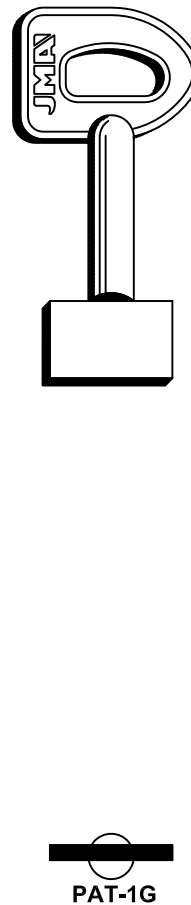

CF



PARA-FOR:

POTENT (I)

POTENT

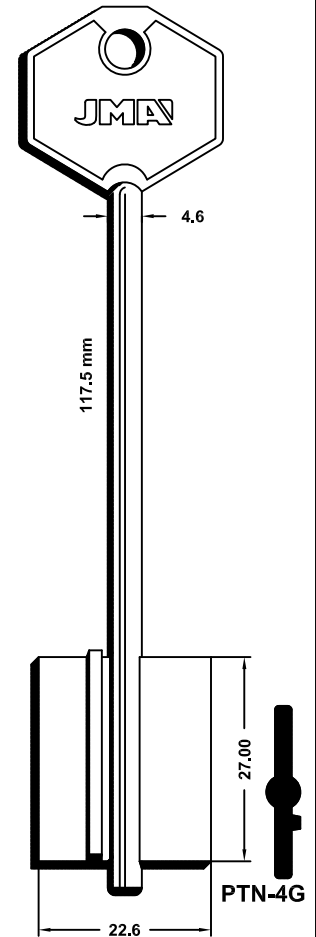
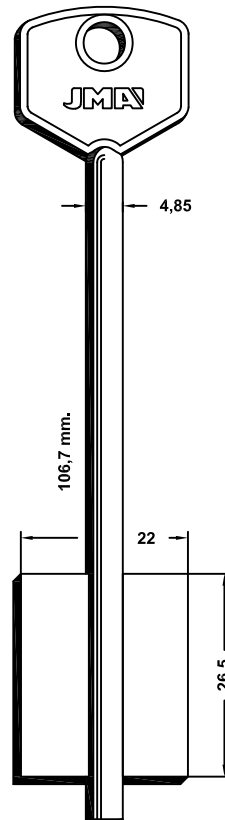
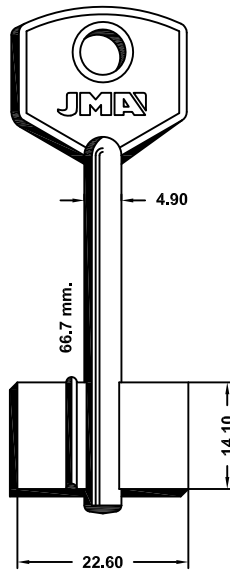
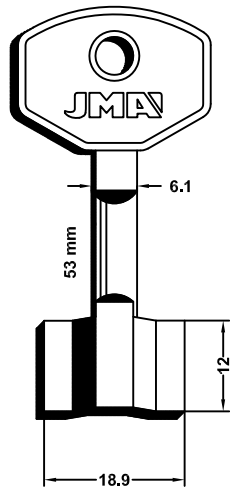

POTENT

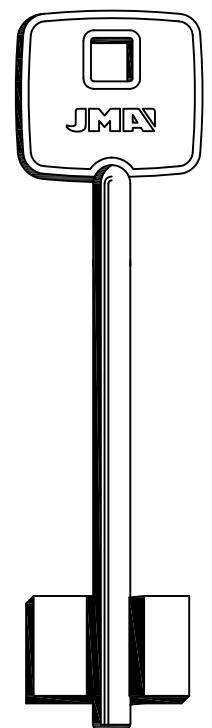
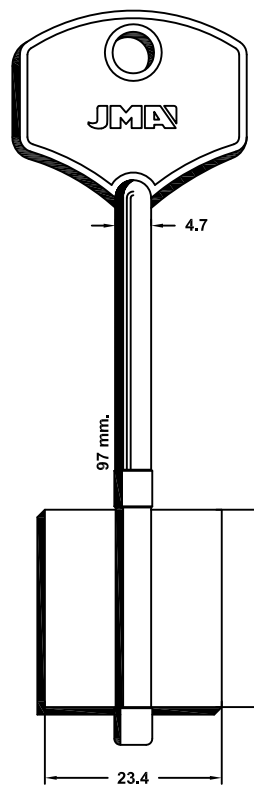
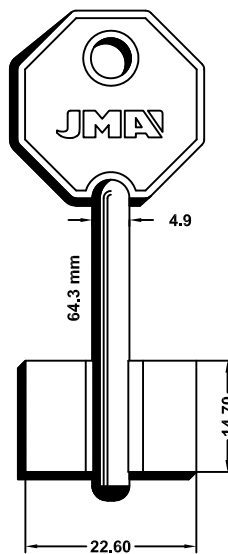
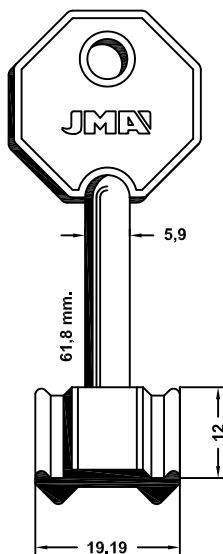

**POTENT**

**PARA-FOR:**

POTENT (I)

PREFER (I)

REVI (E)

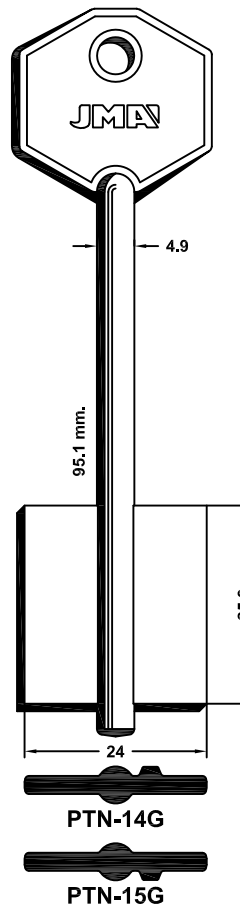
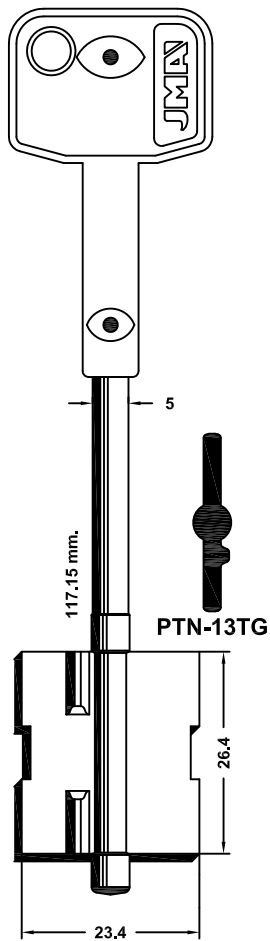
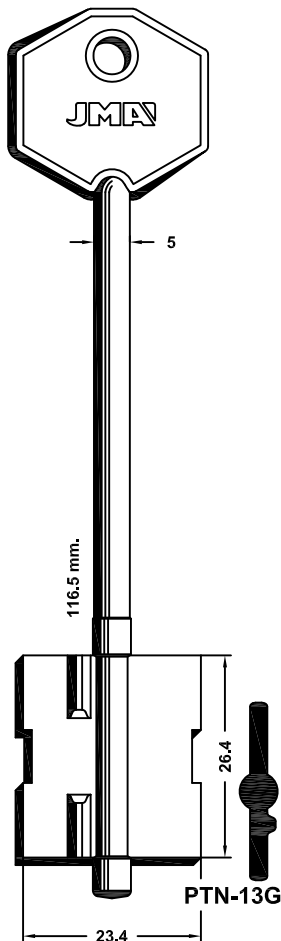
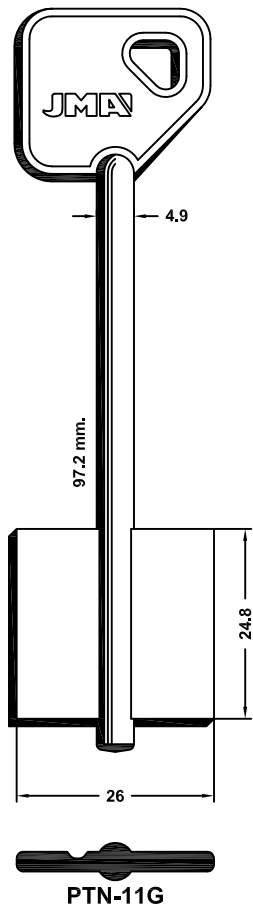

**PREFER**

**REVI**

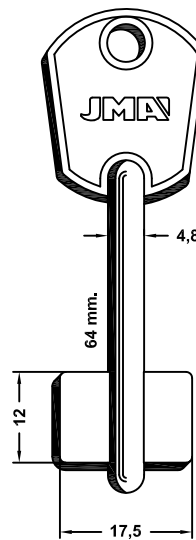
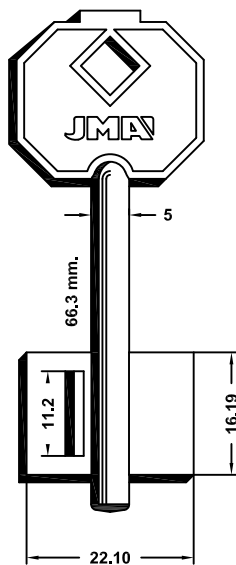
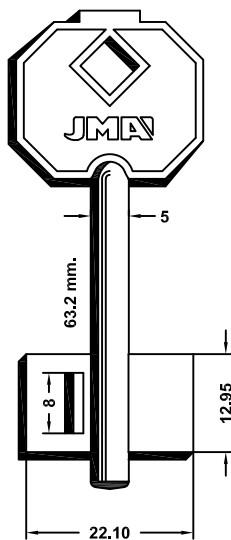
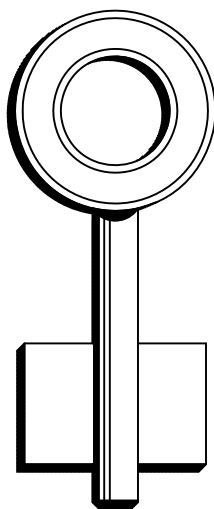

**PARA-FOR:**

RIGAL (RUS)

RUBEN (RUS)

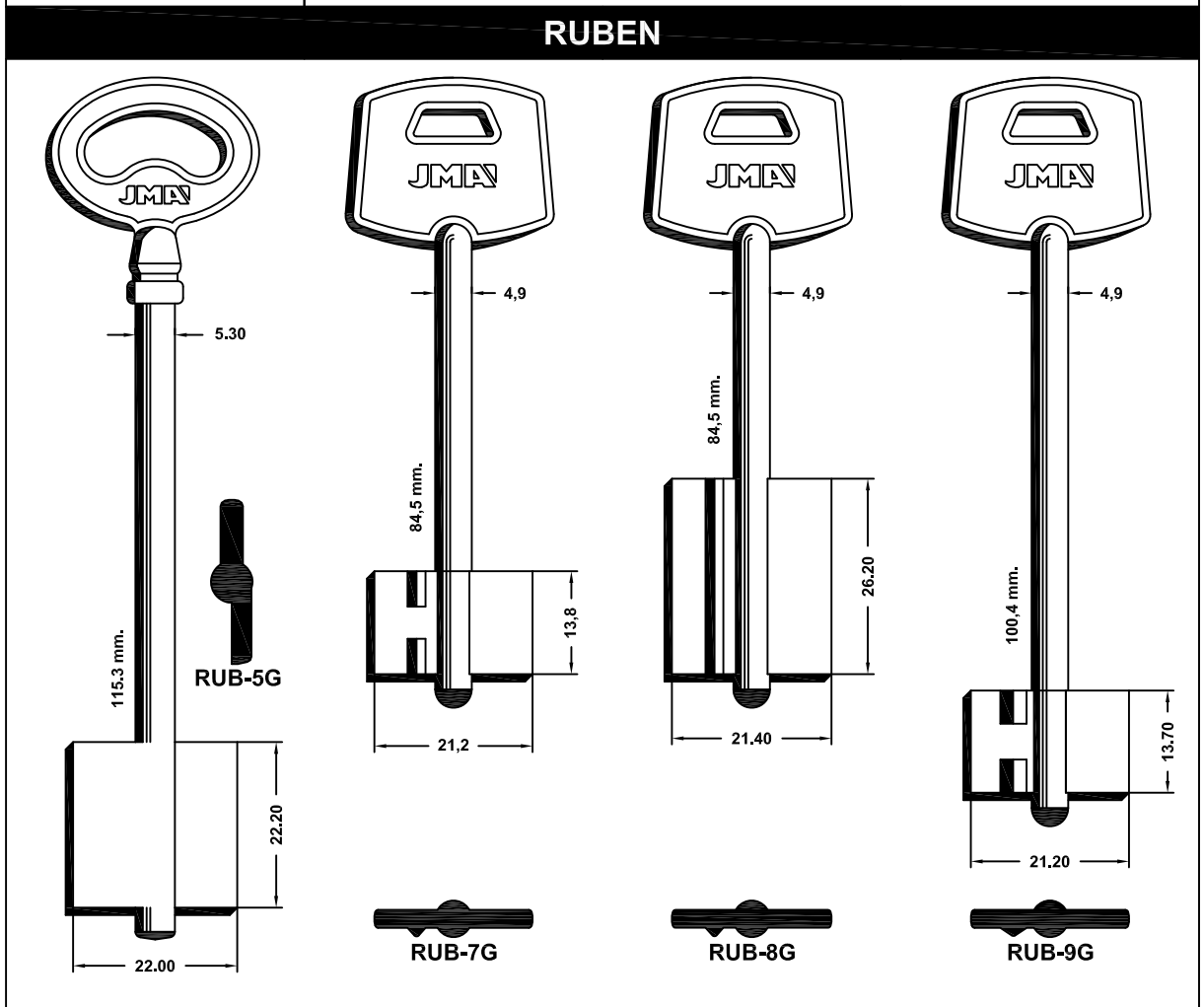
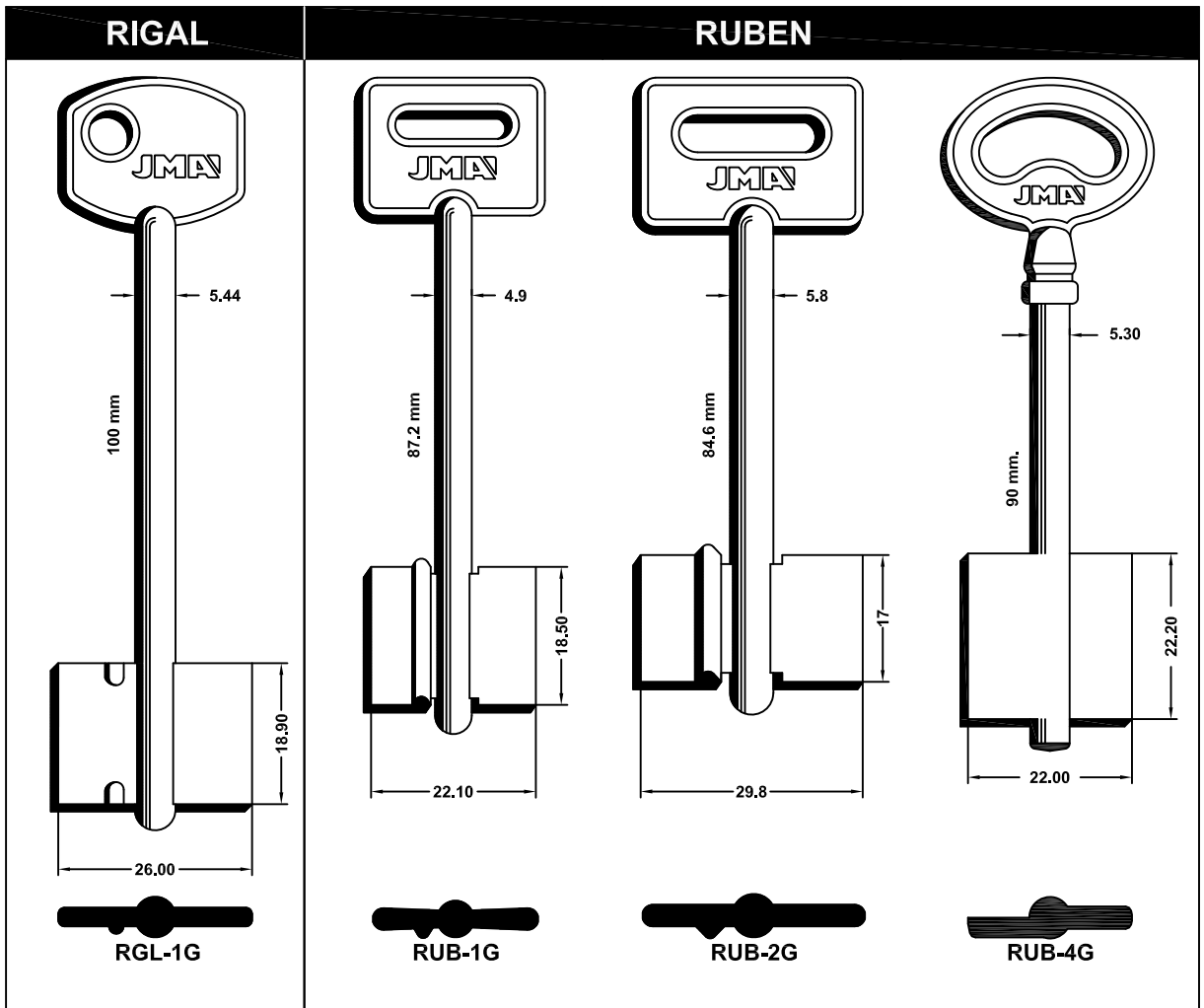



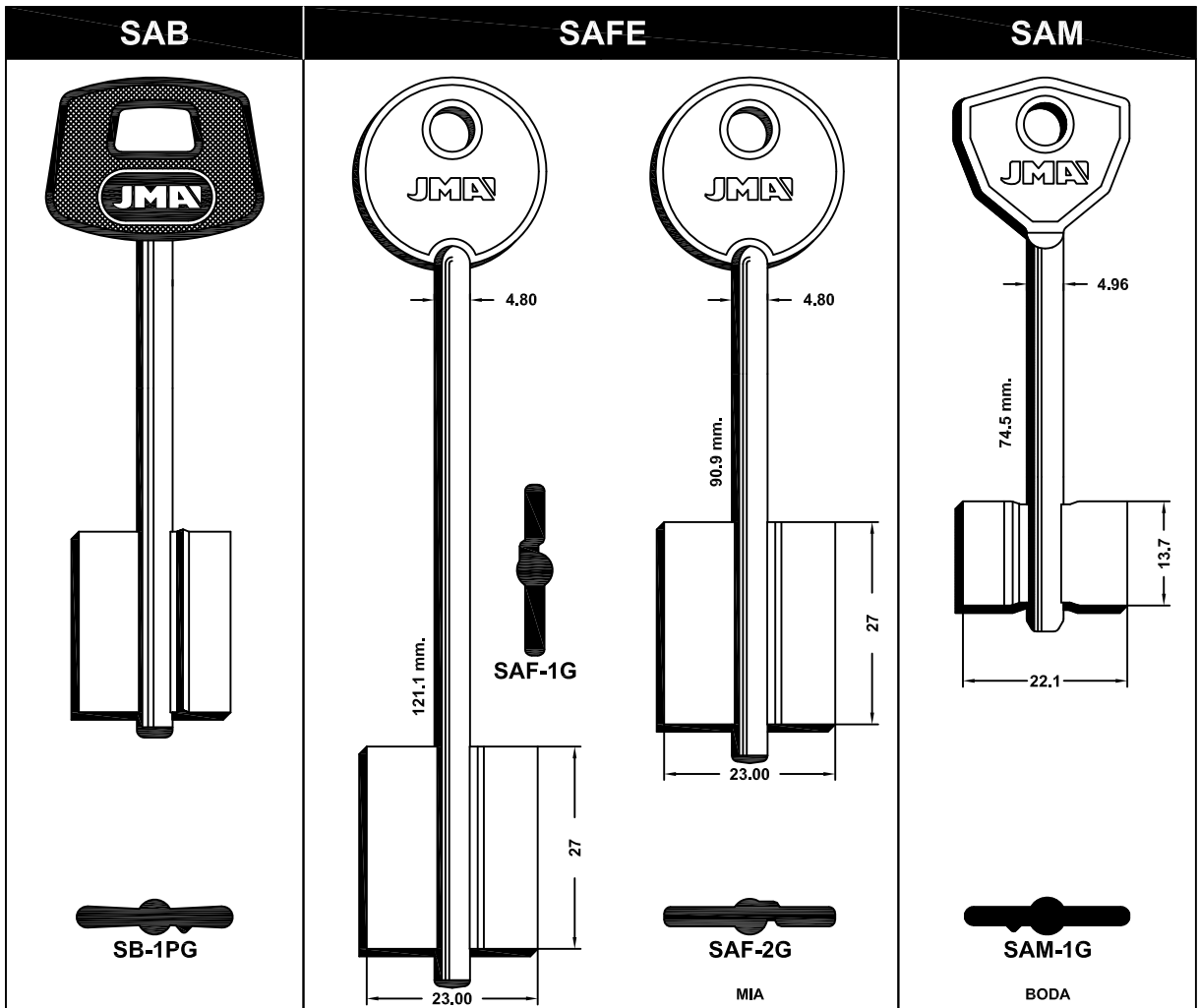

**PARA-FOR:**

- SAB (I)
- SAFE (I)
- SAM (RUS)
- SECUREMME (I)

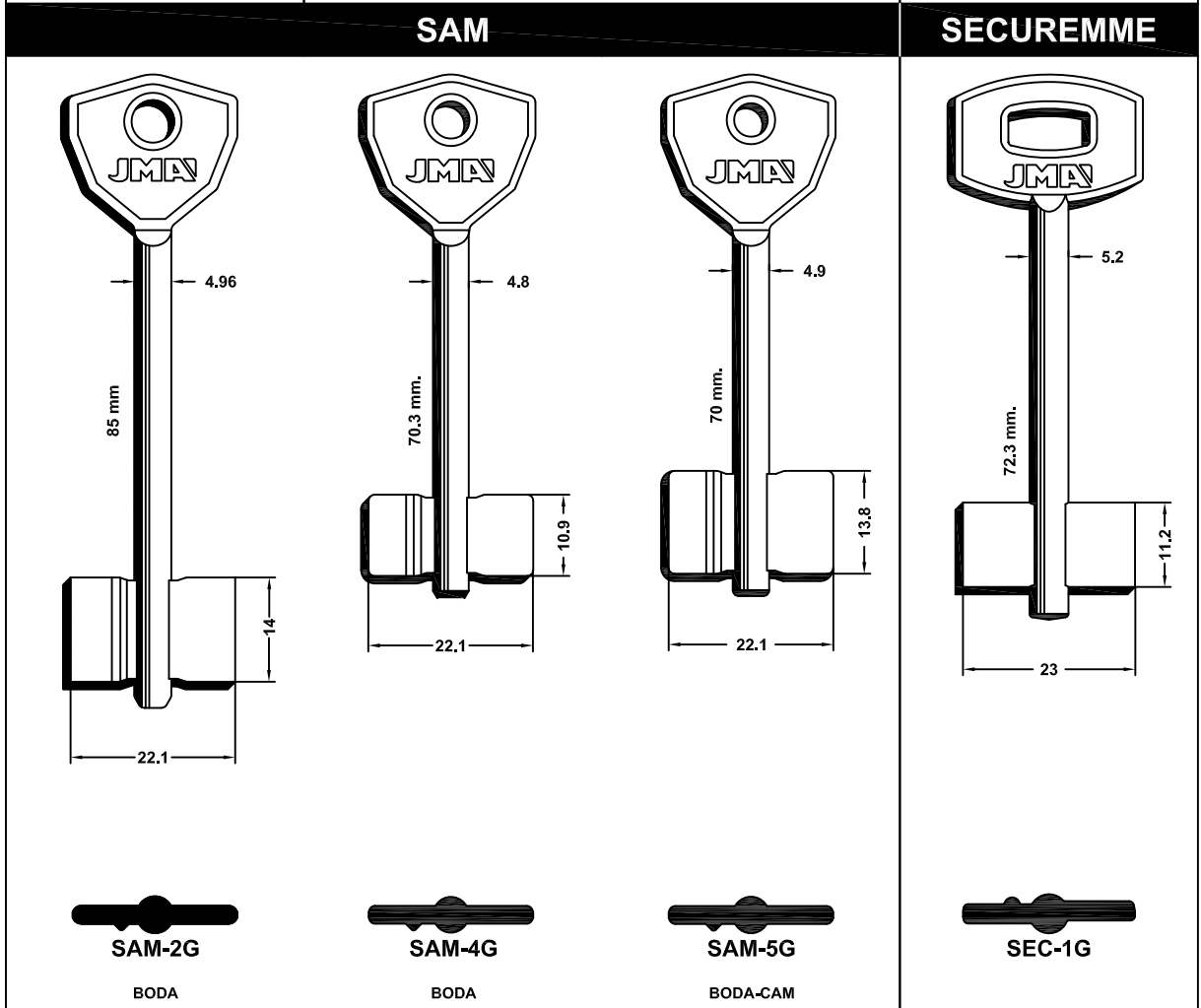

**PARA-FOR:**

**SECUREMME**

SECUREMME (I)

SERMEC (I)

SIAS (I)

SIBI (I)

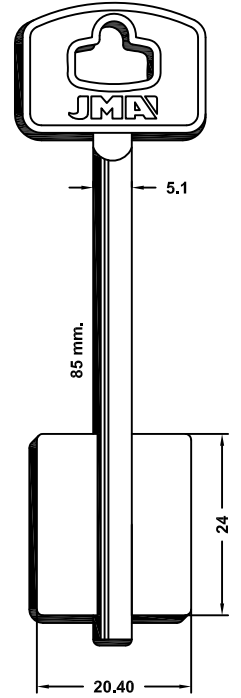
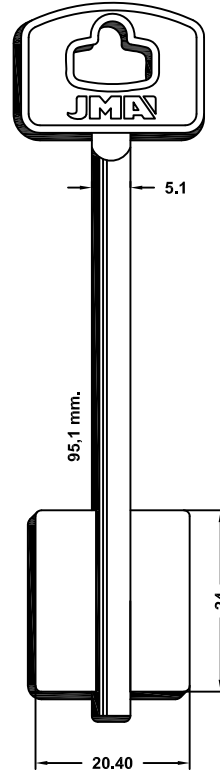
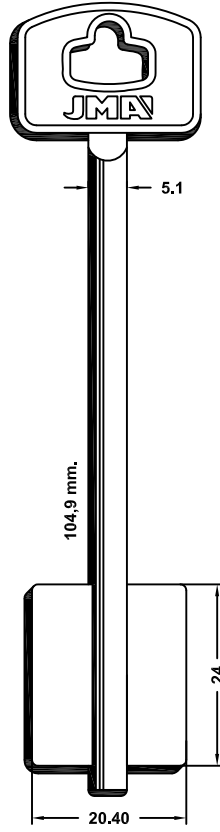
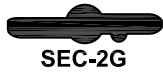
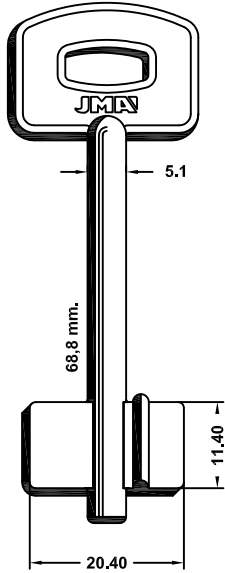

**SERMEC**

**SIAS**

**SIBI**

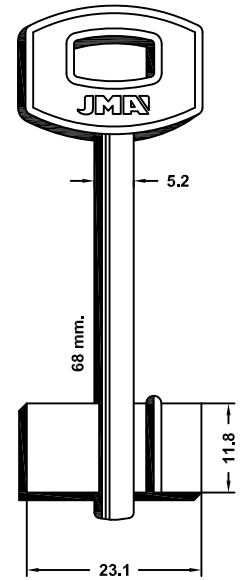
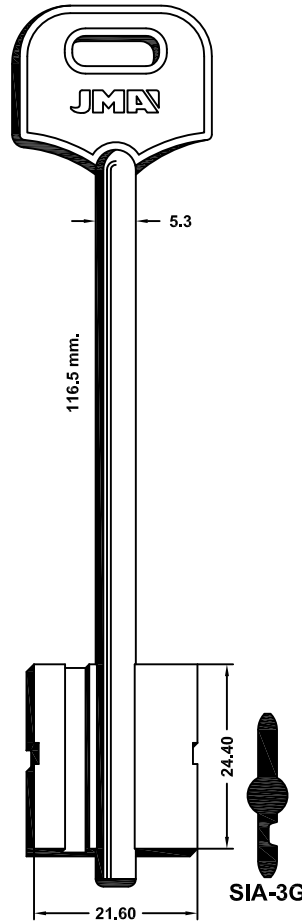
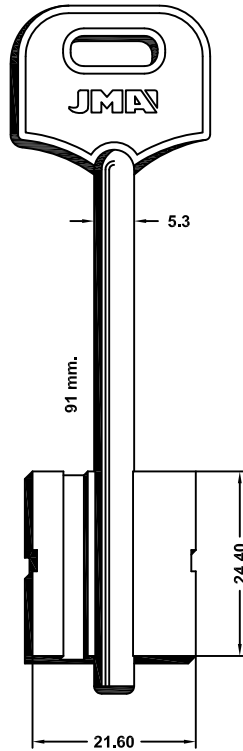
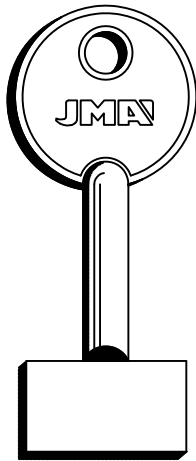

**SIBI**

**SIDERAL**

**PARA-FOR:**

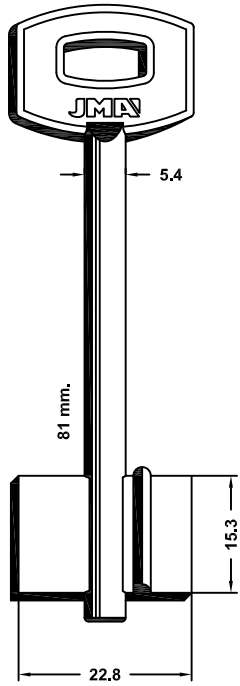

**SIB-3G**

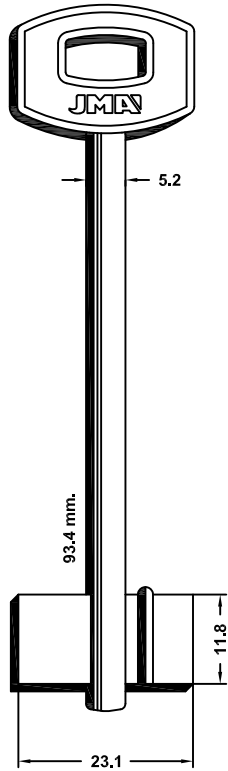

**SIB-4G**

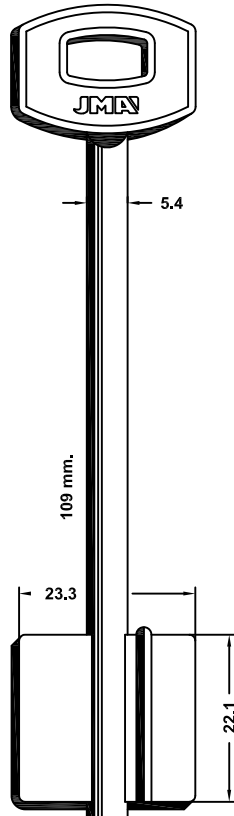

**SIB-5G**

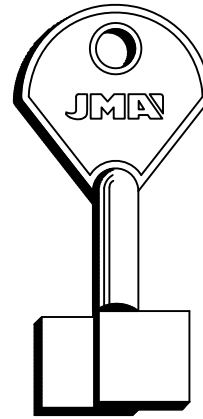

**SDR-1G**

SIBI (I)

SIDERAL (I)

TECSESA (E)

TESIO (I)

**SIDERAL**

**TECSESA**

**TESIO**

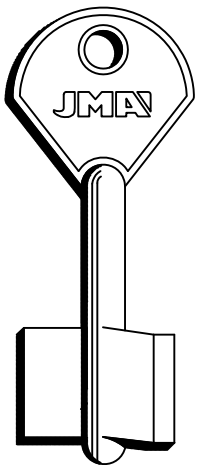

**SDR-2G**

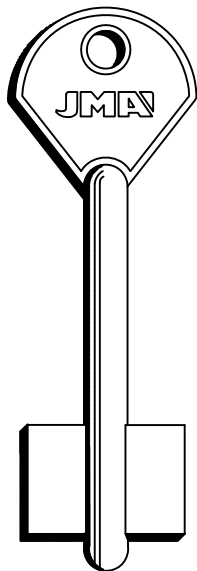

**SDR-3G**

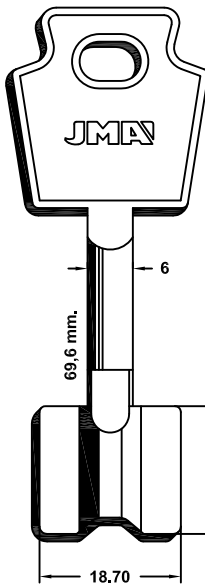

**TEC-1G**

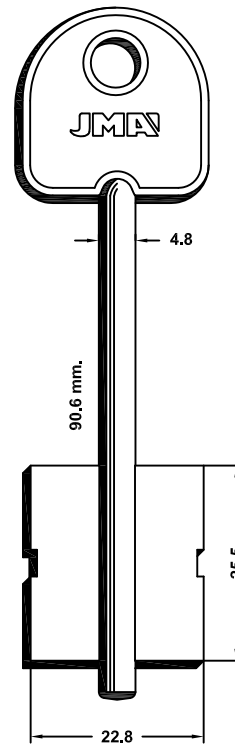

**TSI-1G**



**PARA-FOR:**





TITANIO (I)



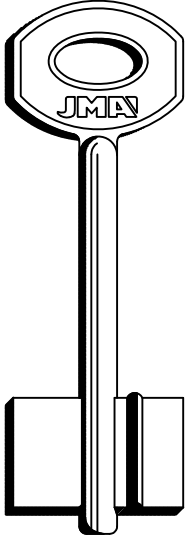
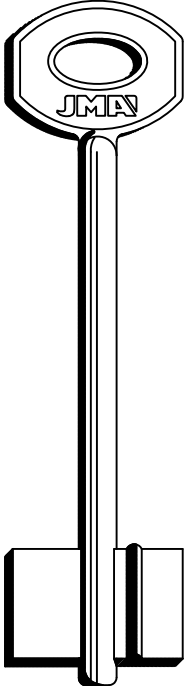
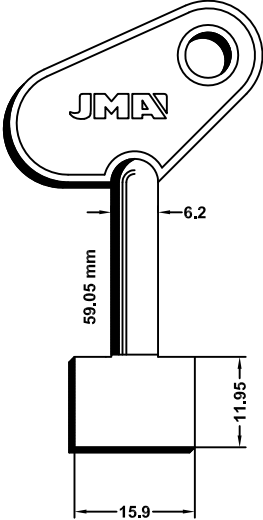
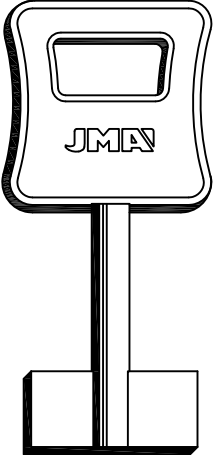

TOVER (E)

4 TR (I)

TUSHINO (RUS)

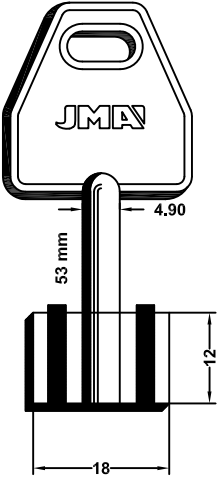
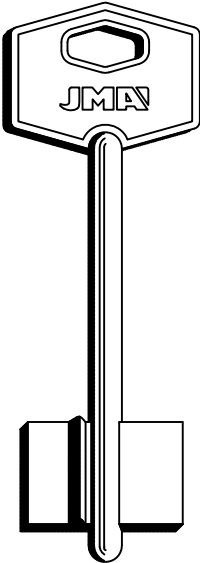
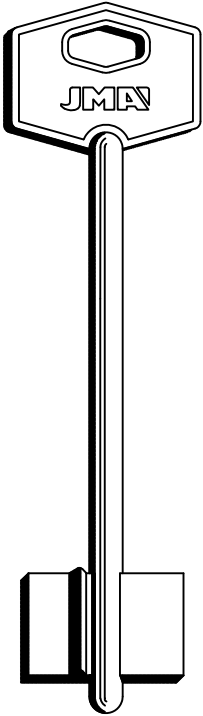
WELKA (I)

TITANO		TOVER	4 TR
			
			
TTN-1G	TTN-2G	TOV-1G	TR-1G

TUSHINO	WELKA	
		
		
TUS-1G	WE-1G	WE-2G



# YALE

PARA-FOR:

YALE (I)

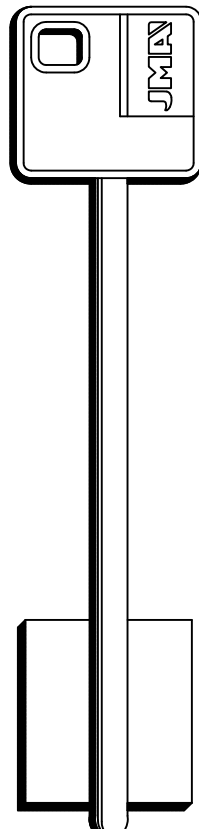
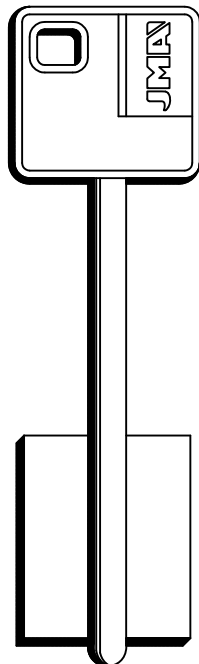
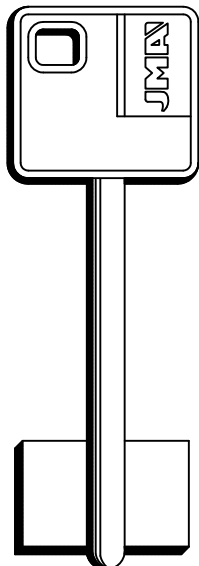
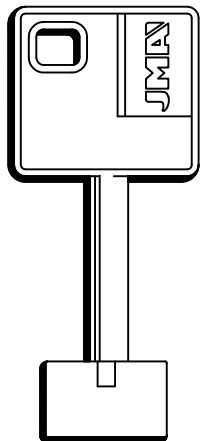

YA-1G



YA-2G



YA-3G



YA-4G



PARA-FOR:

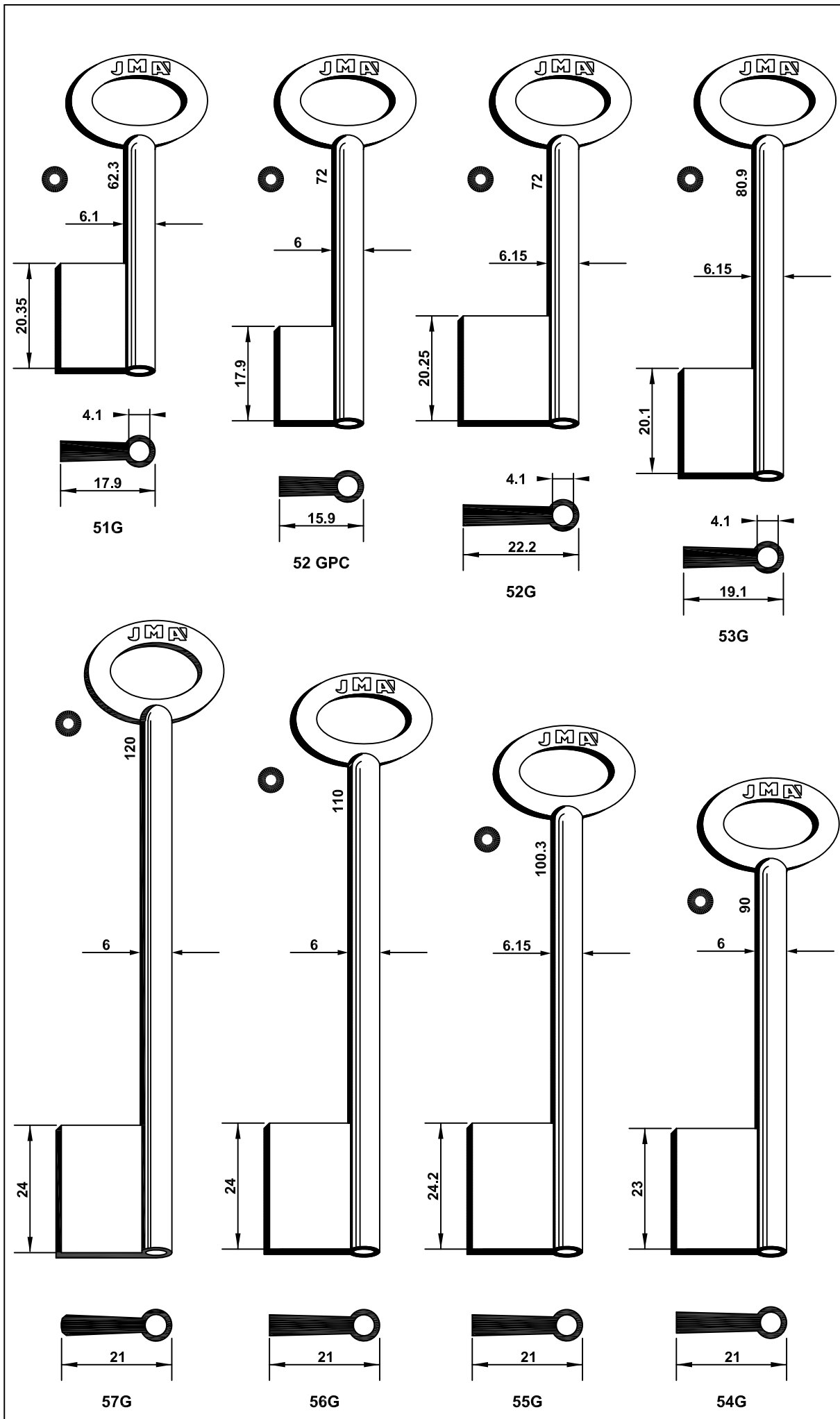

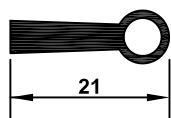
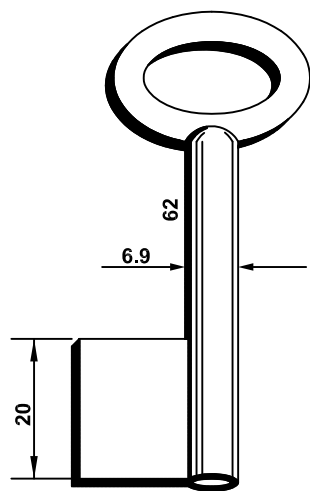

66G

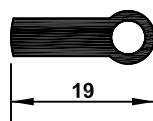
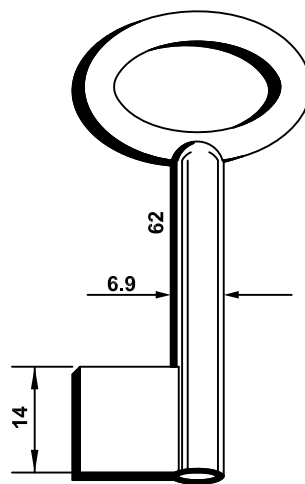

68G

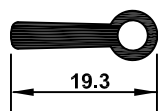
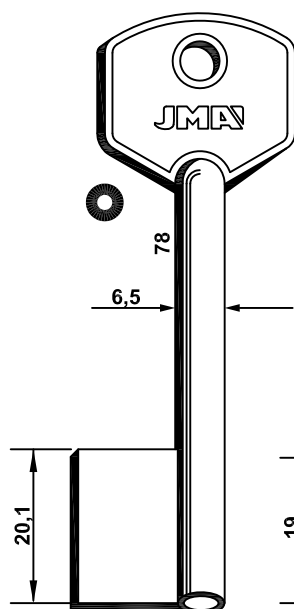

72G

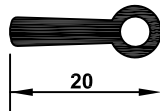
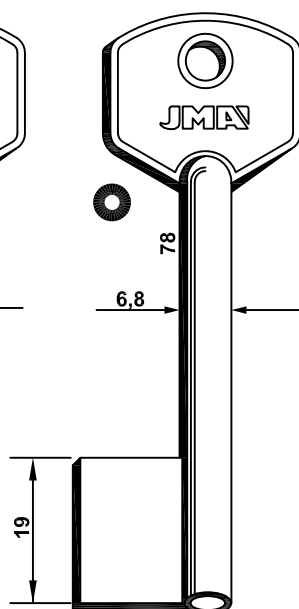

73G



**PARA-FOR:**

- ABUS (D)
- AGA (E)
- ALEDAL (S)
- ARCU (E)

		ABUS	AGA
	<p>AD-33T <math>\varnothing 4</math></p>	<p>ABU-2G</p>	<p>AGA-2G <math>\varnothing 4,1</math></p>
AGA	ALEDAL	ARCU	
<p>AGA-3G <math>A \varnothing 4,1</math></p> <p>AGA-5G <math>B \varnothing 4,1</math></p>	<p>ALE-1G <math>\varnothing 7,4</math></p>	<p>ARC-1G <math>\varnothing 4,1</math></p>	<p>ARC-2G <math>\varnothing 4,05</math></p>





## ARCU

PARA-FOR:

ARCU (E)

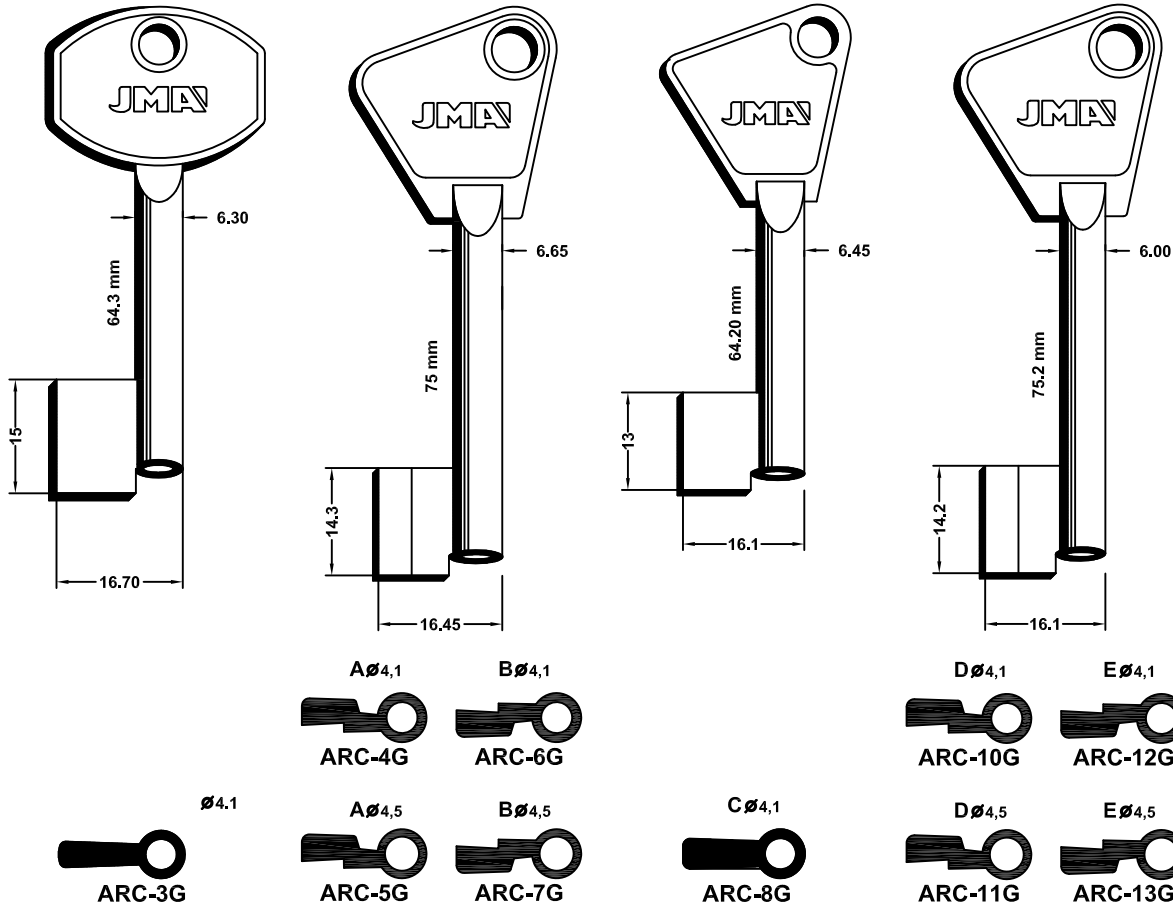

## ARCU

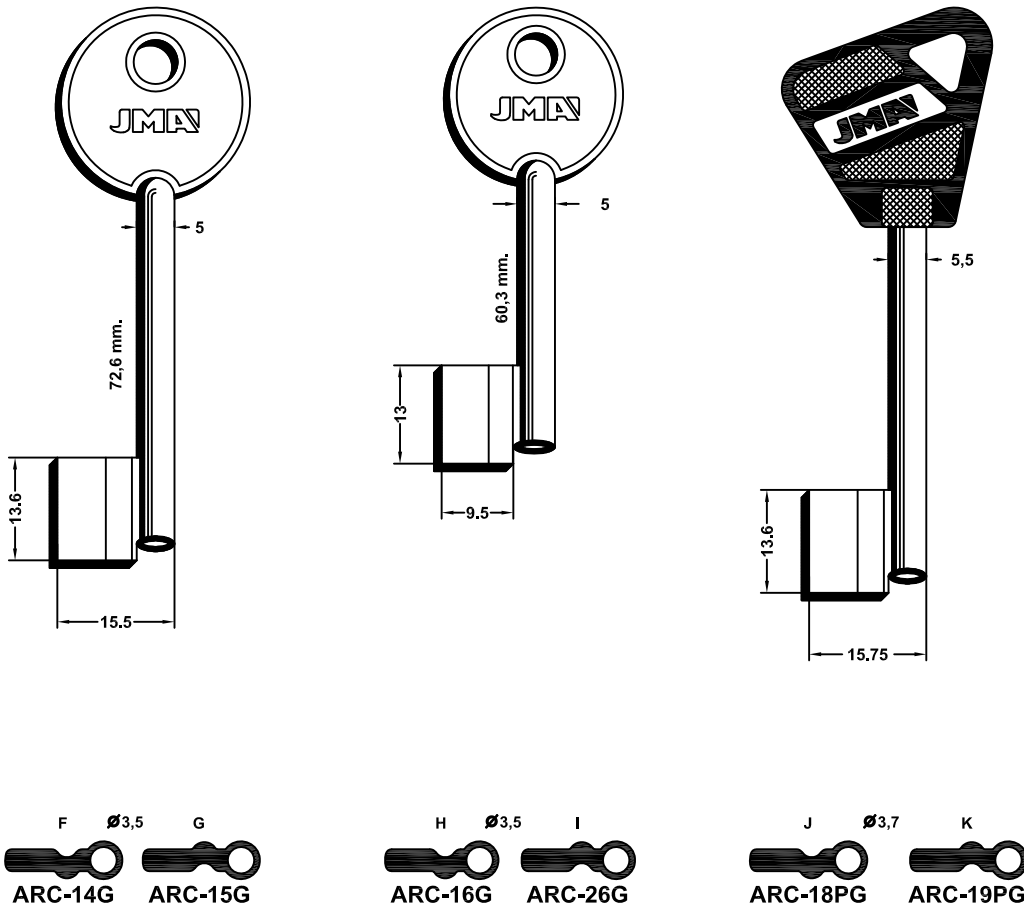

**PARA-FOR:**

ARCU (E)

ASSA (S)

AYPE (E)

CERUTTI (I)

LAR (E)

**ARCU**

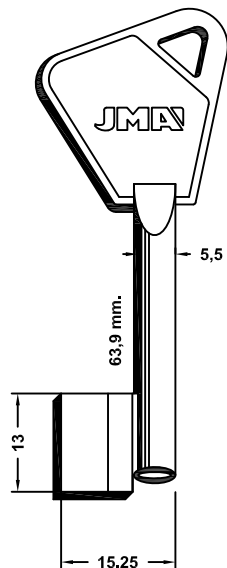
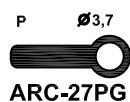
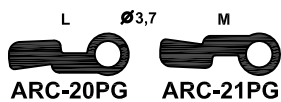
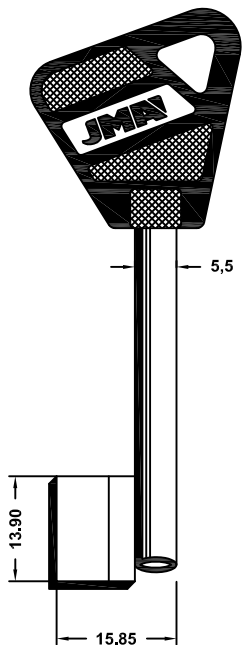

**ASSA**

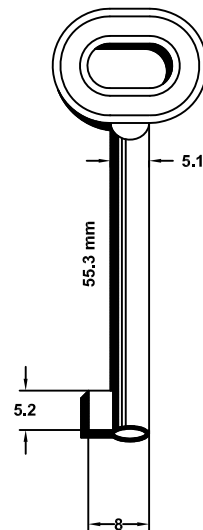

**AYPE**

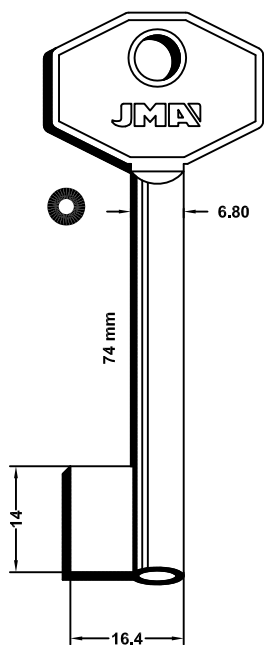

**CERUTTI**

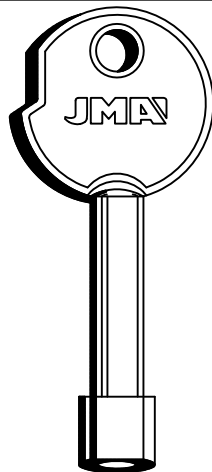

**LAR**

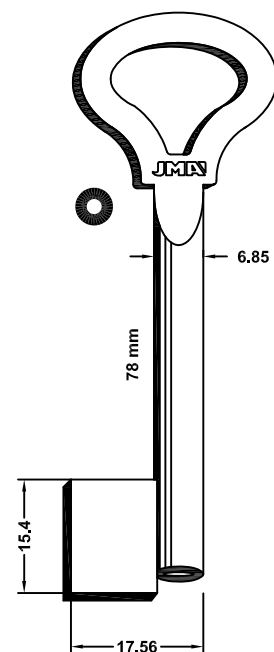
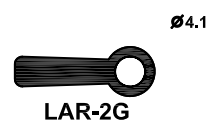
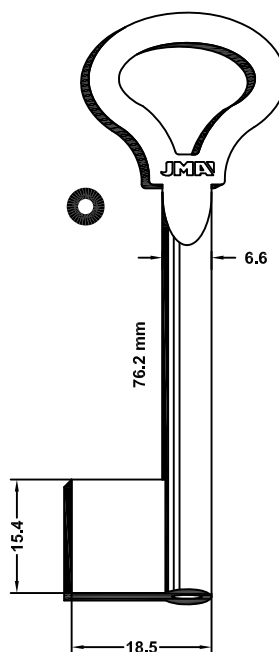

# ORENGO

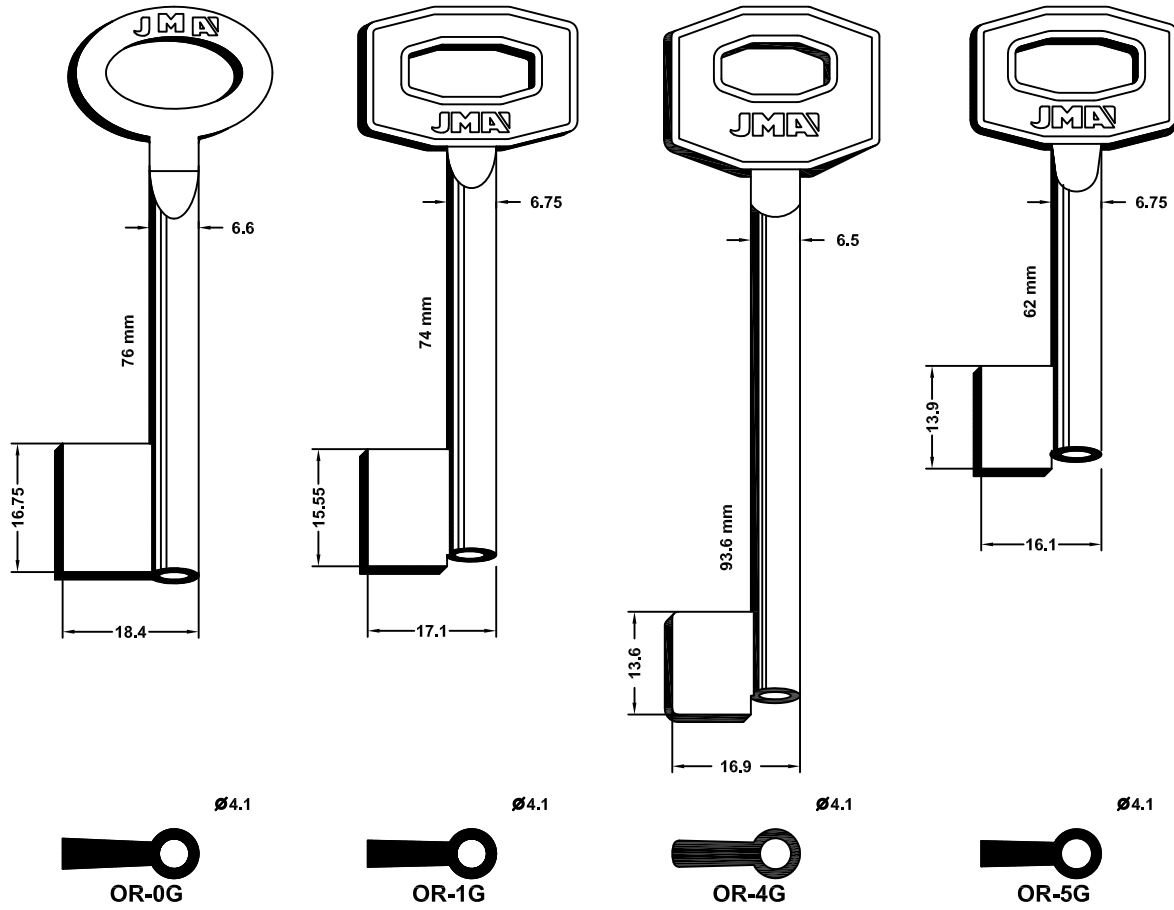

# PARA-FOR:

- ORENGO (E)
- RUBEN (RUS)
- RUE (F)
- VILLFER (E)

## RUBEN

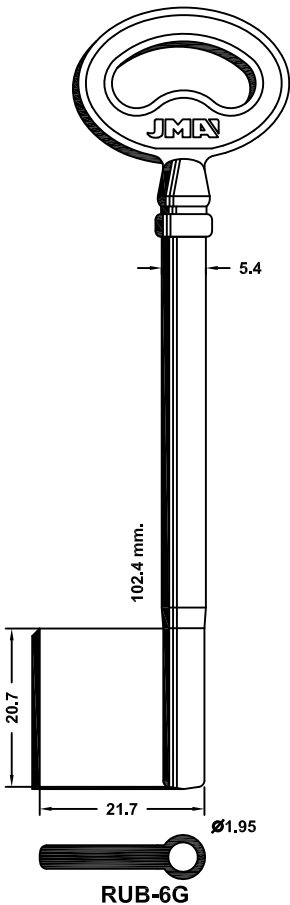

## RUE

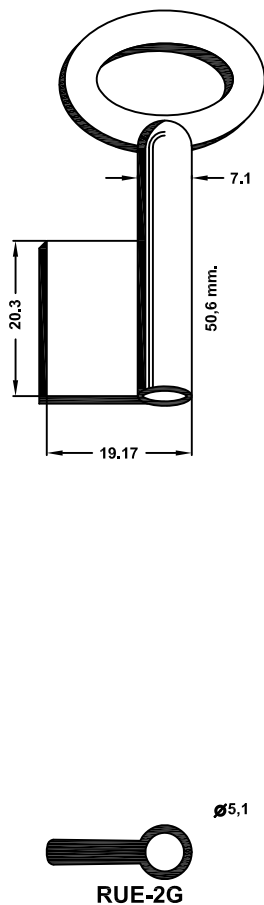

## VILLFER

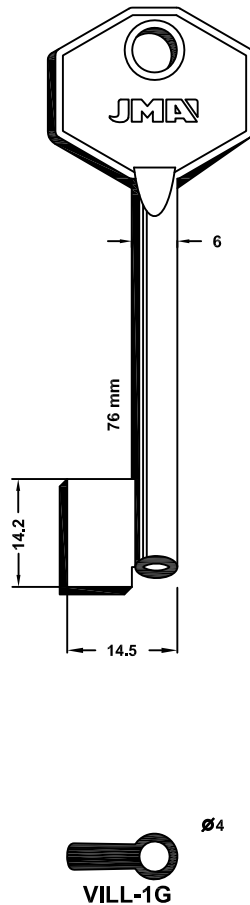



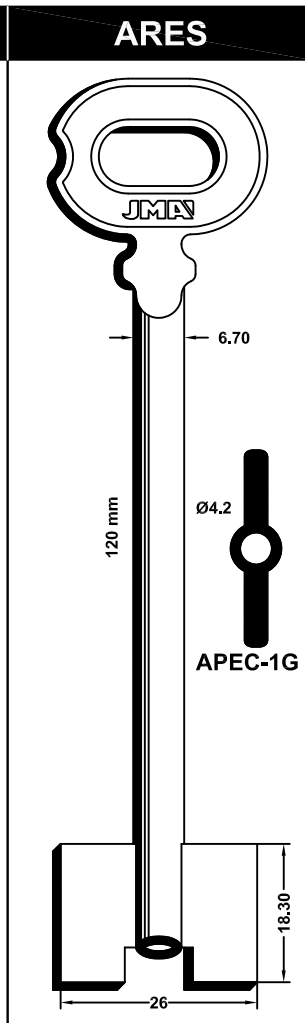
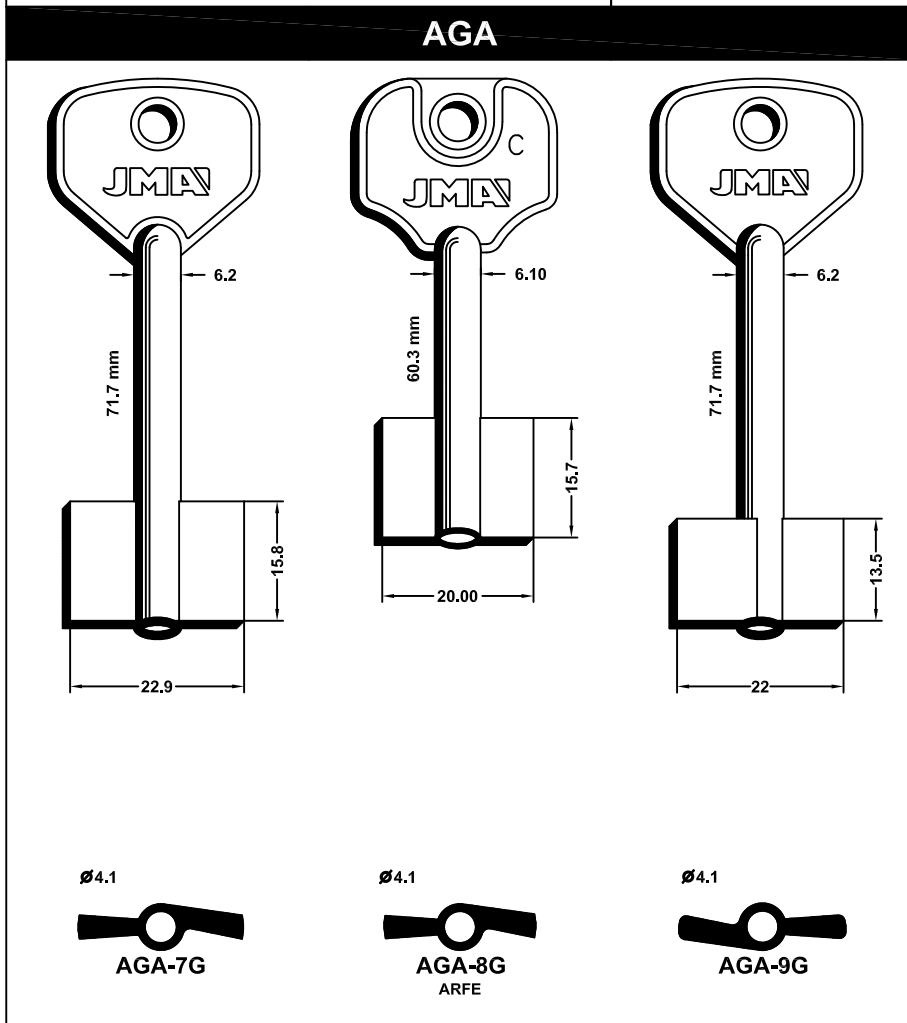
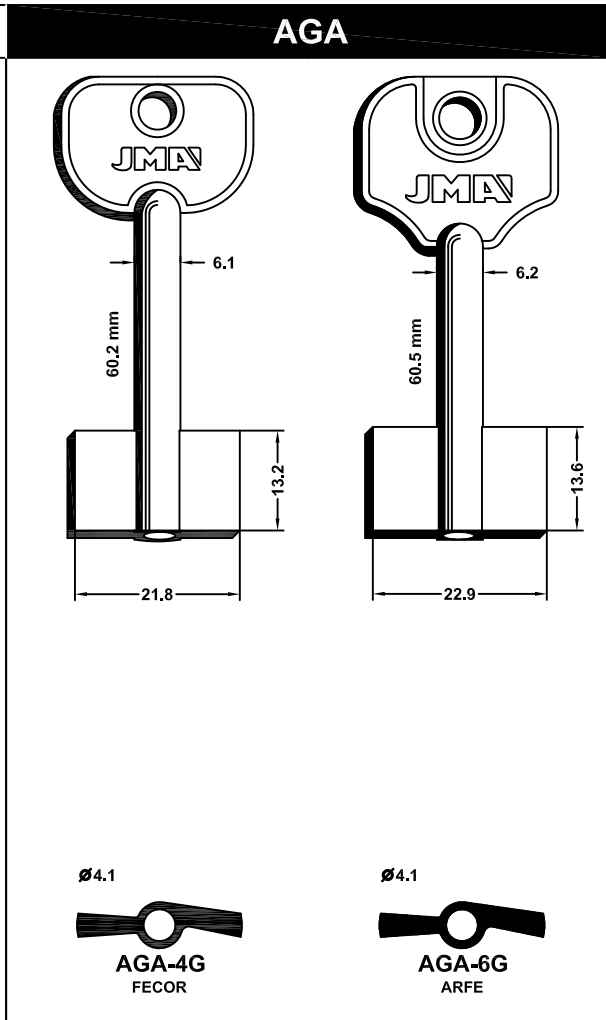
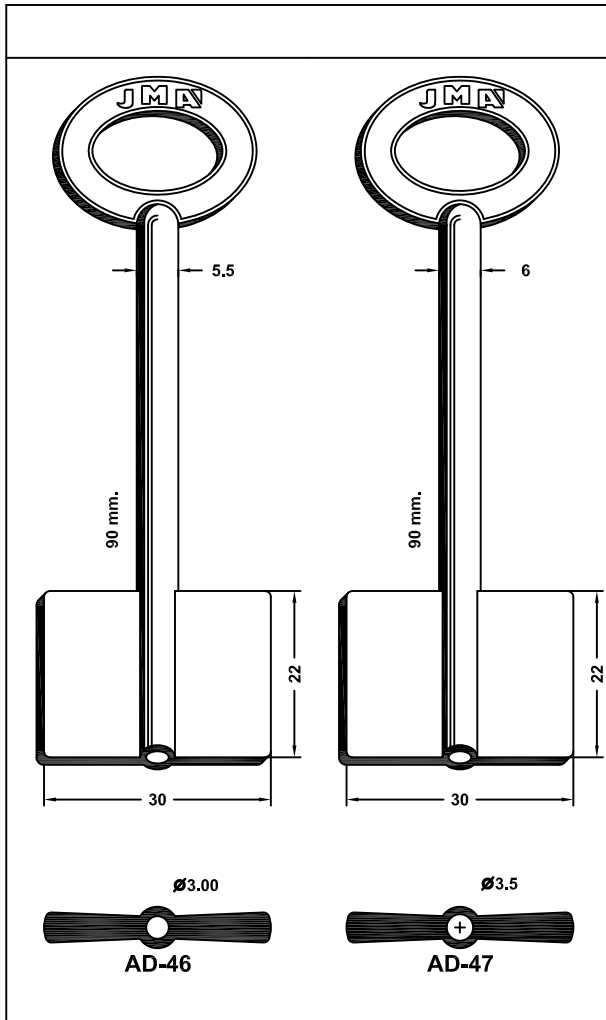

**PARA-FOR:**

AGA (E)

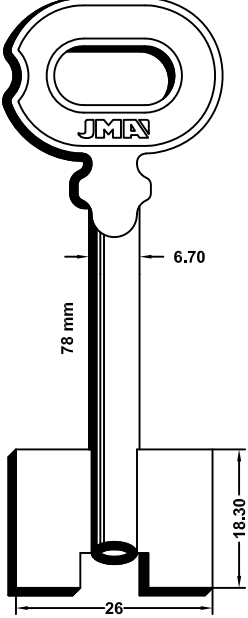
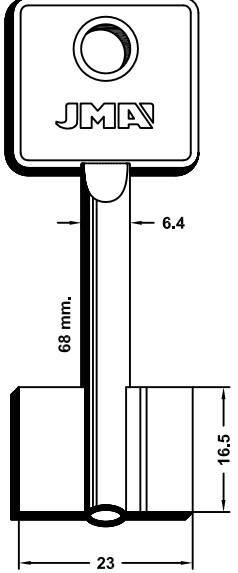
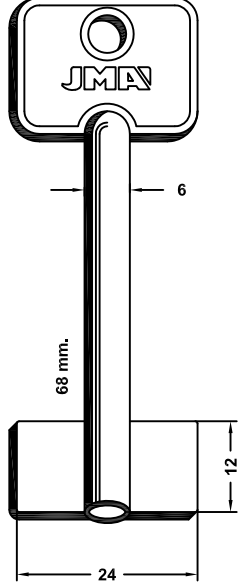
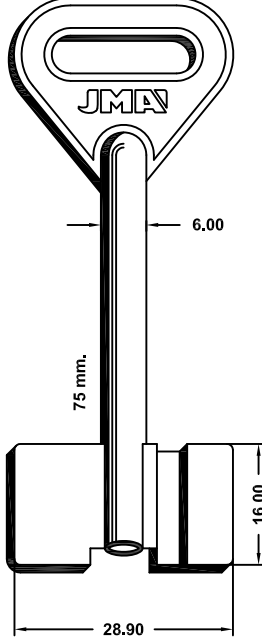



ARES (RUS)

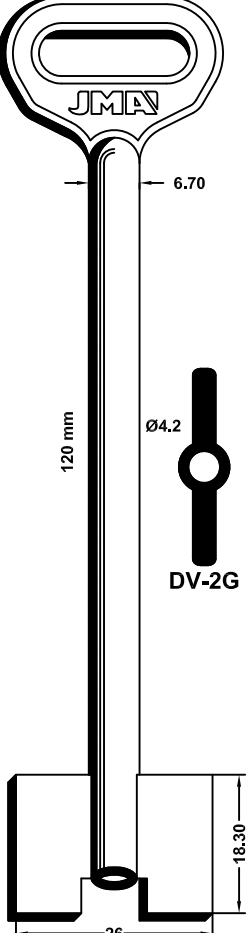
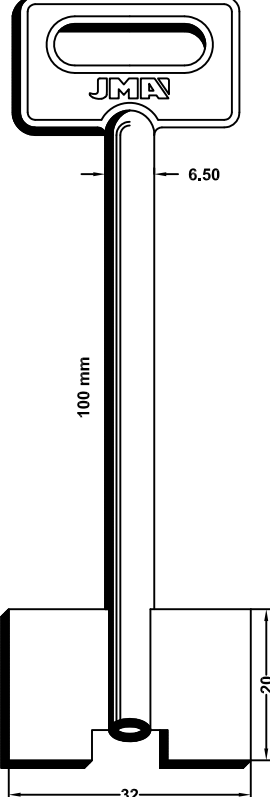
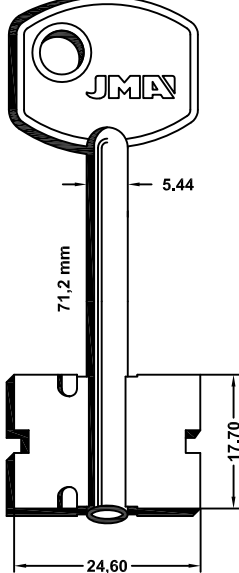
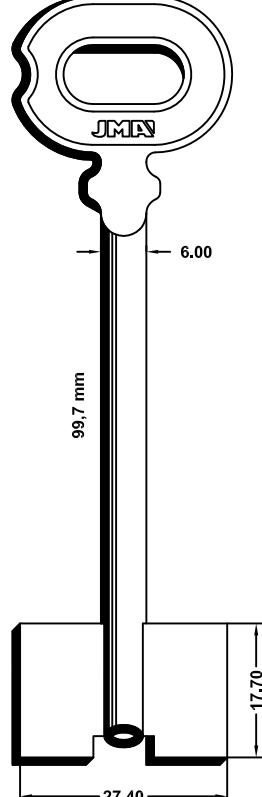

ARES	BURG	CRONOS	DUPLEX
 <p>78 mm 6.70 18.30 26</p>	 <p>68 mm. 6.4 16.5 23</p>	 <p>68 mm. 6 12 24</p>	 <p>75 mm. 6.00 16.00 28.90</p>
 <p>Ø4.20 <b>APEC-2G</b></p>	 <p>Ø4 <b>BUR-1G</b></p>	 <p>Ø4 <b>CRO-1G</b></p>	 <p>Ø3,5 <b>DUP-1G</b></p>

**PARA-FOR:**  
 ARES (RUS)  
 BURG (D)  
 CRONOS  
 DUPLEX (RUS)  
 DVERNIAK (RUS)

**DVERNIAK**

 <p>120 mm 6.70 18.30 26</p>	 <p>100 mm 6.50 20 32 Ø3.80</p>	 <p>71,2 mm 5.44 17.70 24,60</p>	 <p>99,7 mm 6.00 17.70 27.40 Ø3.60</p>
 <p>Ø4.2 <b>DV-2G</b></p>	 <p>Ø3.80 <b>DV-4G</b></p>	 <p>Ø3.7 <b>DV-10G/A</b></p>	 <p>Ø3.60 <b>DV-11G</b></p>



**PARA-FOR:**

DVERNIAK (RUS)

EREVAN (RUS)

MACOR (E)

MAXIM (RUS)

PREFER (I)

RUBEN (RUS)

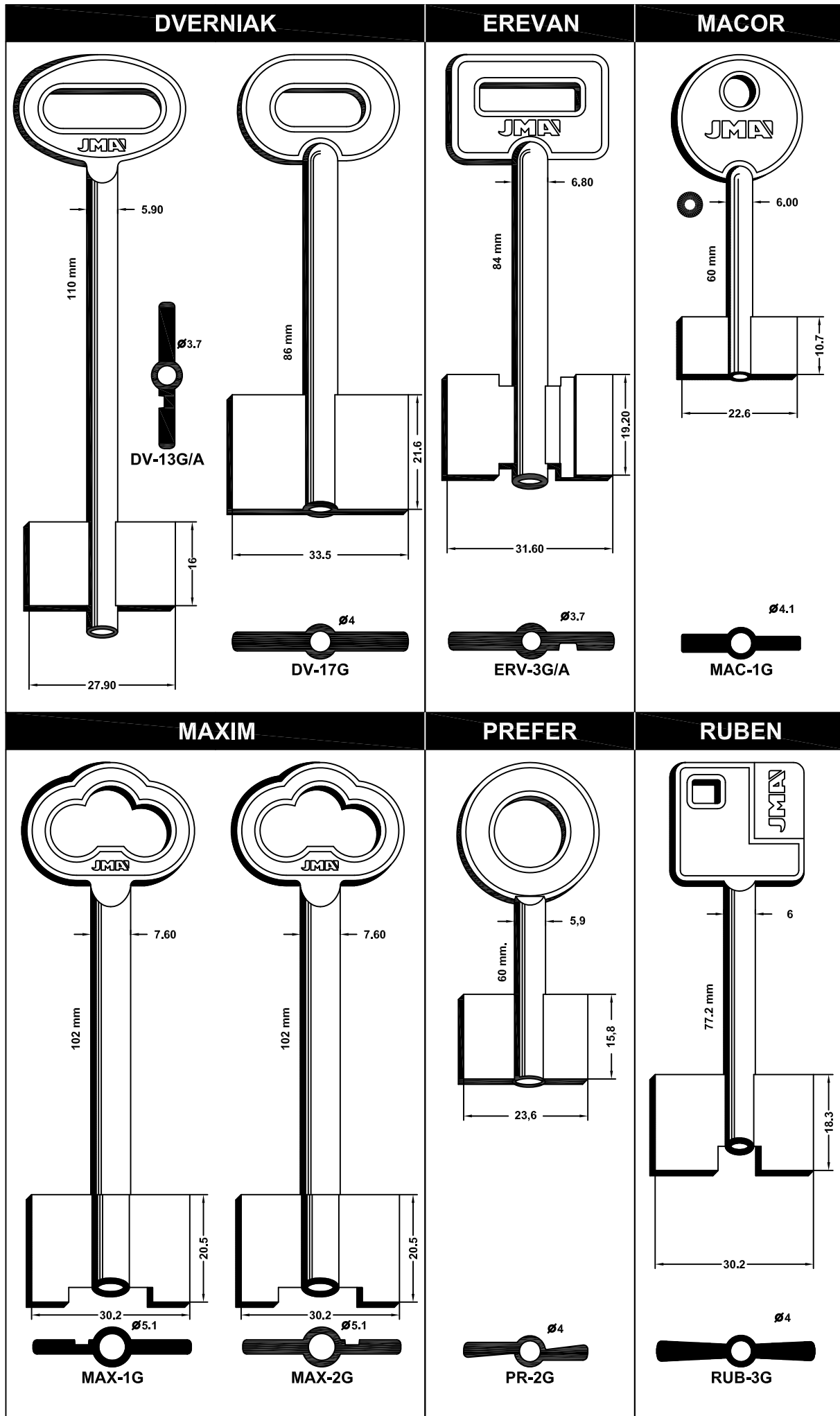

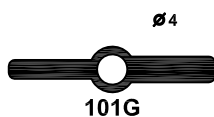
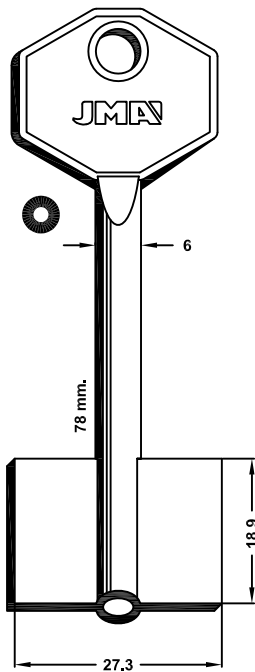
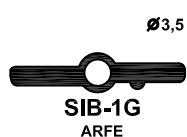
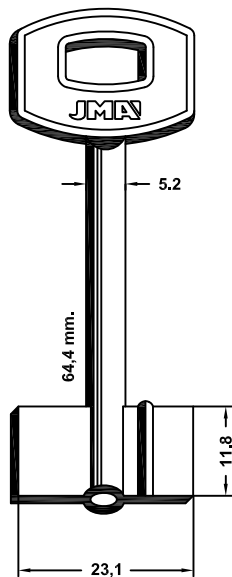
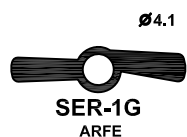
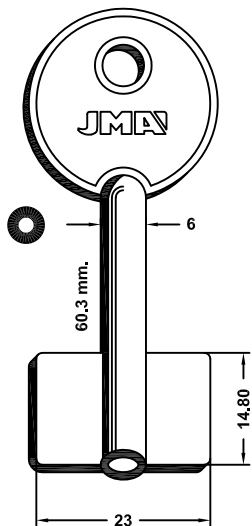
**SERRALLER****SIBI**

**PARA-FOR:**  
SERRALLER (E)  
SIBI (I)



# ***LLAVES DE GORJA ZAMAK***

*ZAMAKEZKO GORJA GILTZAK*

*ZAMAK BIT KEYS*

*CLES A GORGES EN ZAMAK*

*CHUBBSCHLÜSSEL AUS ZAMAK*



***THE KEY TO EXCELLENCE***  
*GLOBALLY UNLOCKING MILLIONS OF DOORS DAILY*



# AGA

PARA-FOR:

AGA (E)

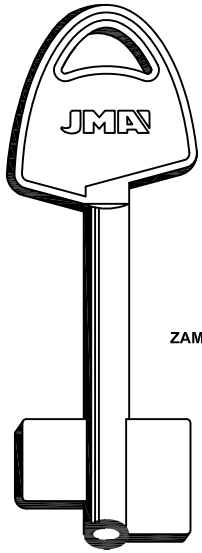

ZAM.

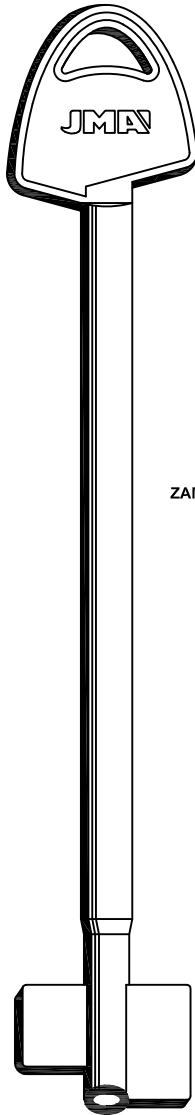

ZAM.

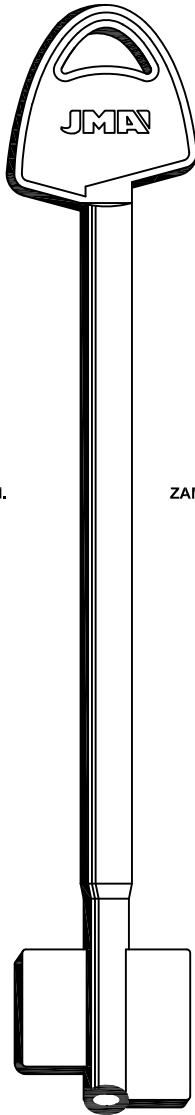

ZAM.

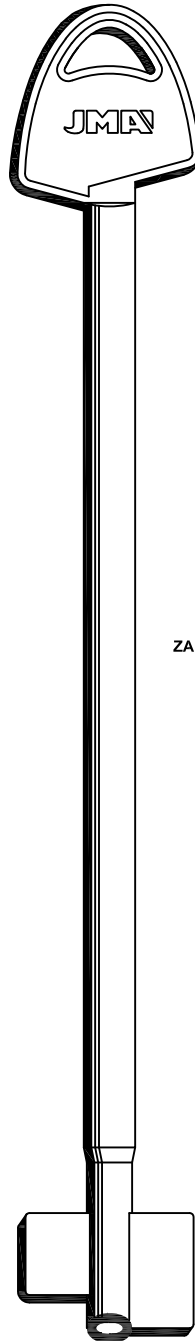

ZAM.

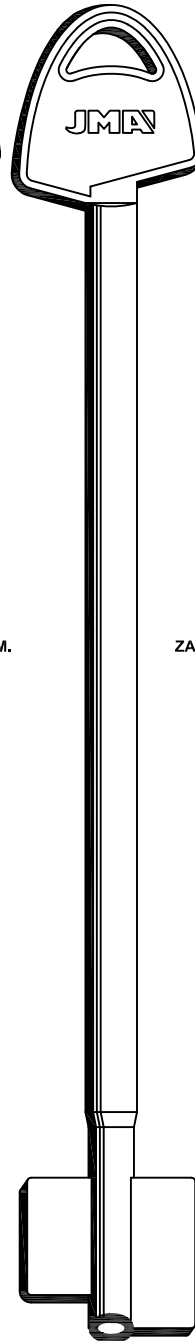

ZAM.



AGA-15G



AGA-23G



AGA-27G



AGA-35G



AGA-40G



**PARA-FOR:**

AGA (E)

CAS CISMA (I)

NEMEF (D)

**AGA**

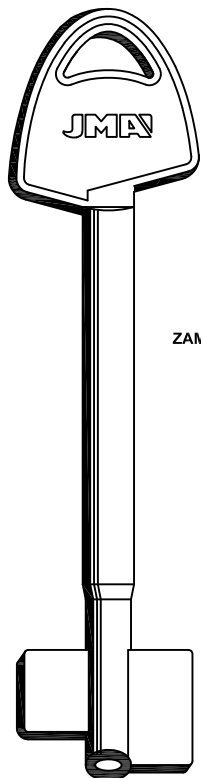

ZAM.



AGA-46G

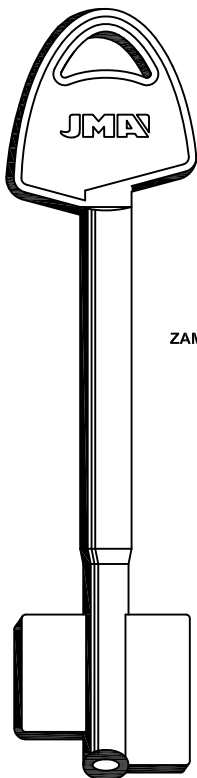

ZAM.



AGA-50G

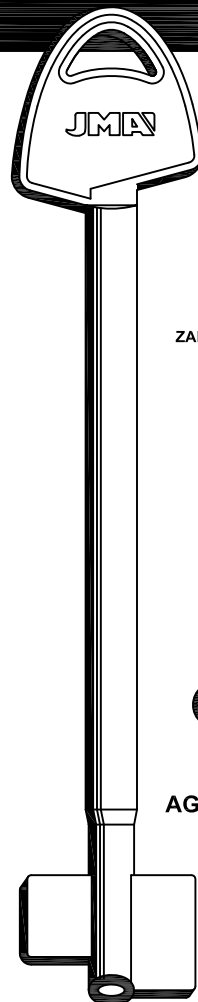

ZAM.

AGA-48G

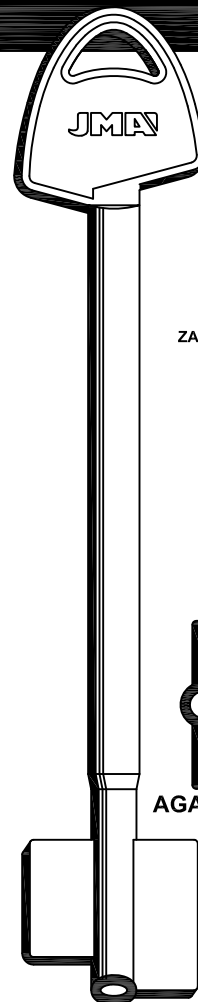

ZAM.

AGA-49G

**CAS CISMA**

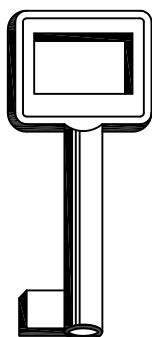

ZAM.



CIS-803/....

**NEMEF**

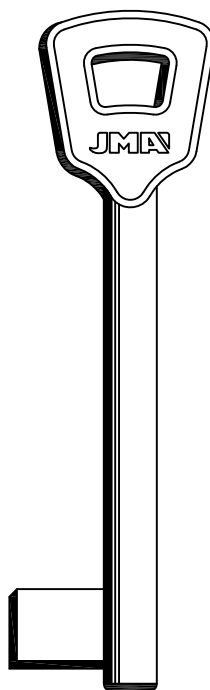

NEF-2Z-..

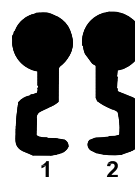

ZAM.

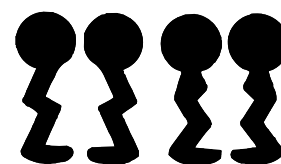
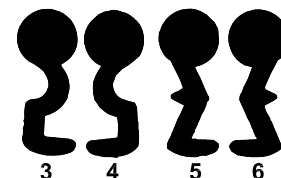

BMH-FH-VACHETTE



# **LLAVES ARTÍSTICAS Y DE ARMARIO LATÓN**

*LETOIZKO GILTZAK: ARMAIRUETARAKO ETA ARTISTIKOAK*

*BRASS FURNITURE KEYS*

*CLES POUR MEUBLES EN LAITON*

*MOBELSCHLÜSSEL AUS MESSING*



**THE KEY TO EXCELLENCE**

*GLOBALLY UNLOCKING MILLIONS OF DOORS DAILY*

PARA-FOR:

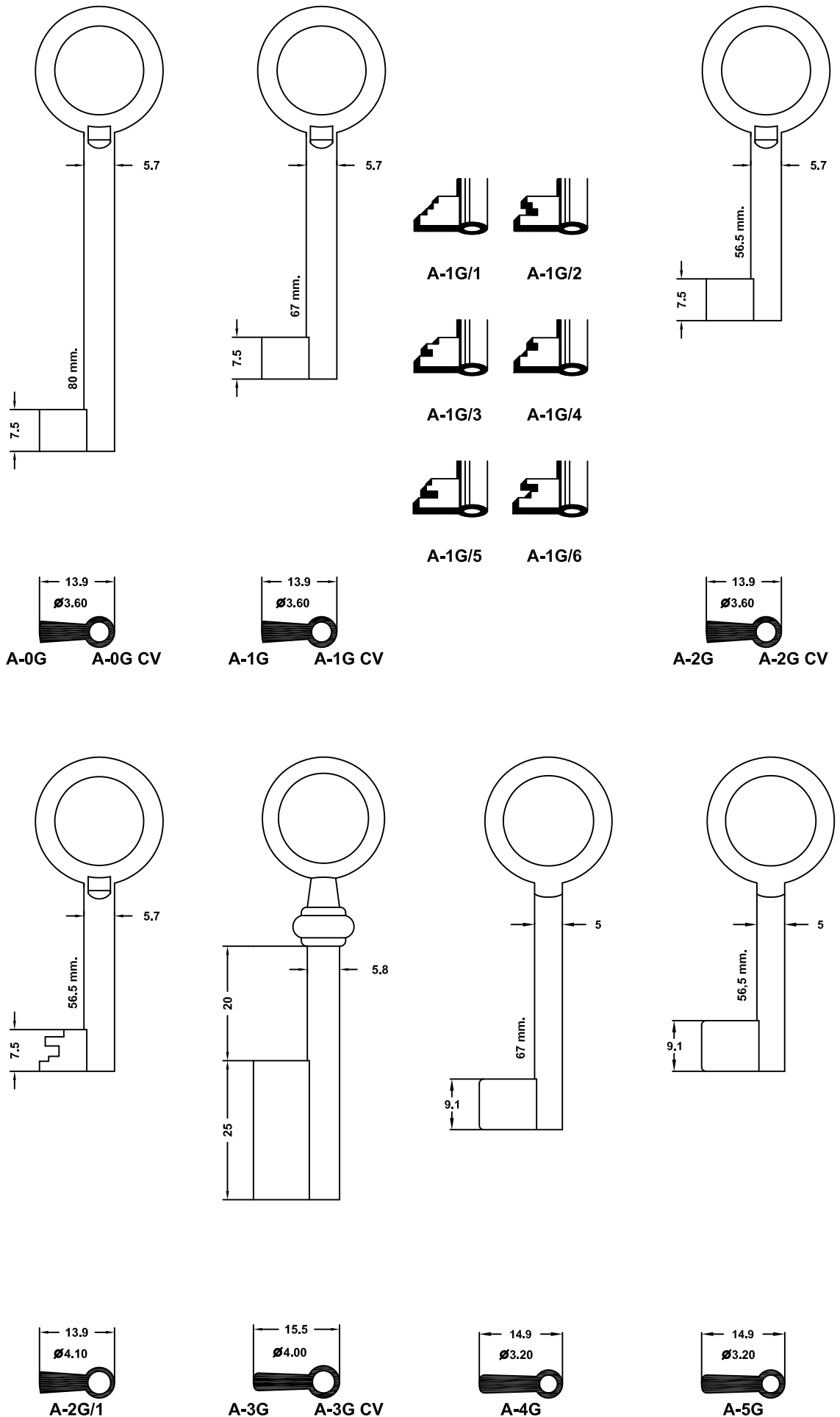

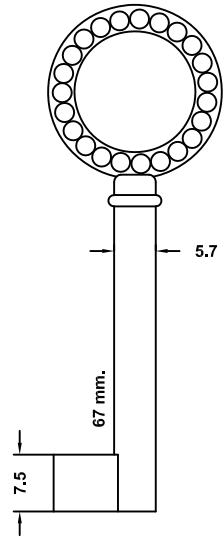

AA-1G AA-1G CV

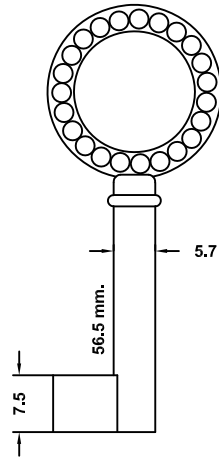

AA-2G AA-2G CV

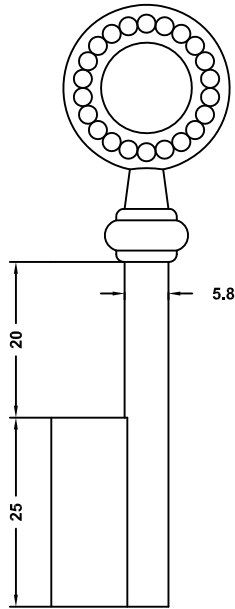

AA-3G AA-3G CV

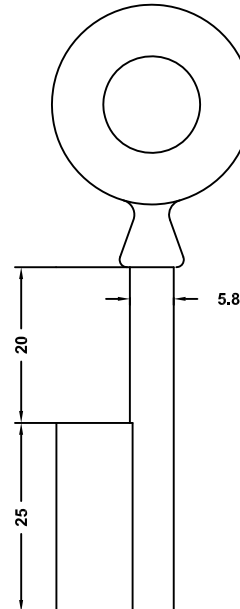

B-3G B-3G CV

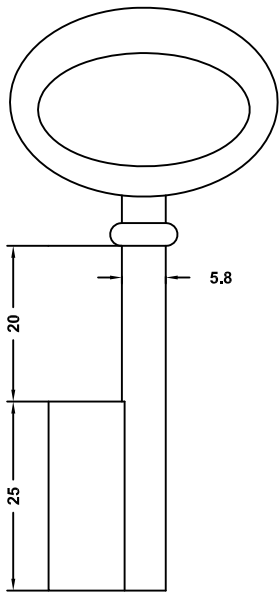
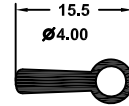
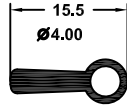
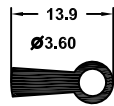

C-3G C-3G CV

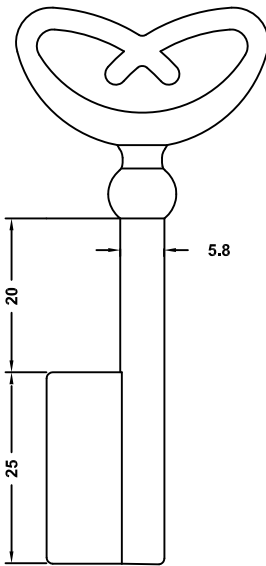

D-3G D-3G CV

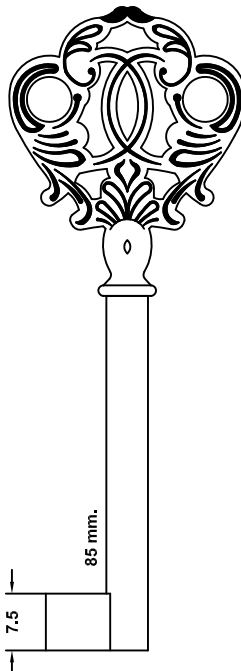

E-0G E-0G CV

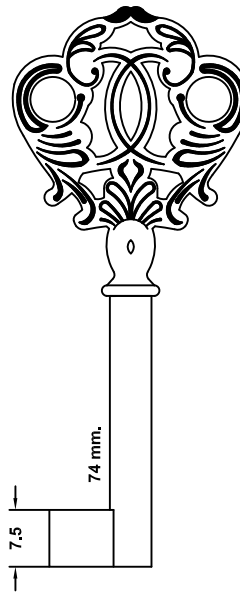

E-1G E-1G CV

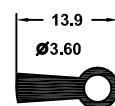
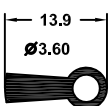
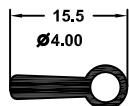
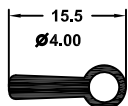

PARA-FOR:

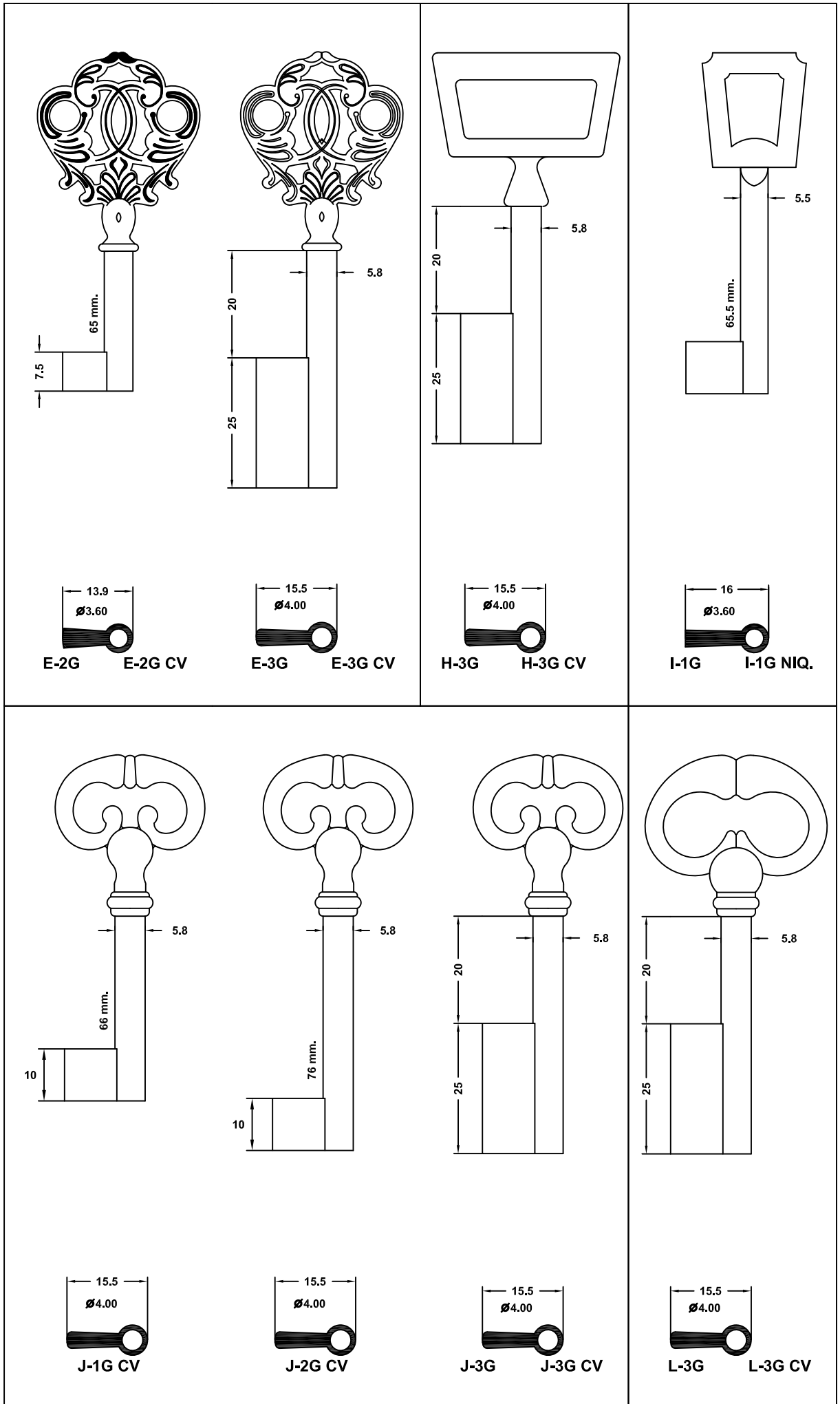

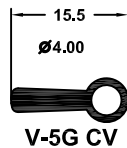
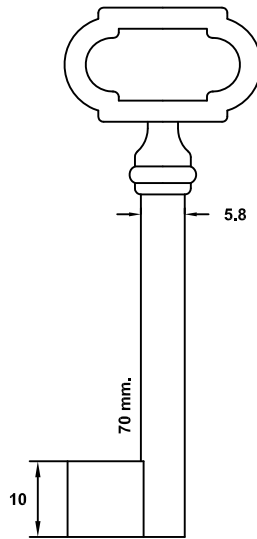
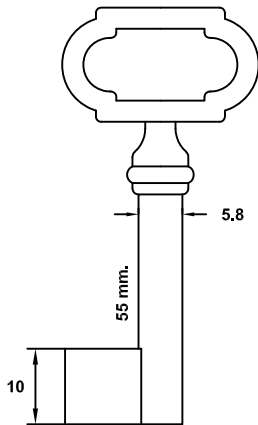
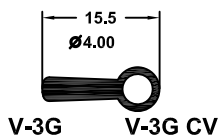
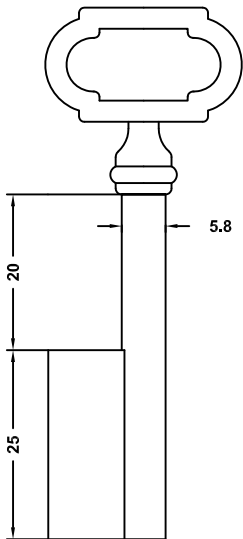
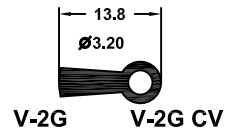
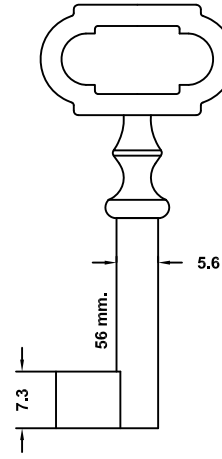
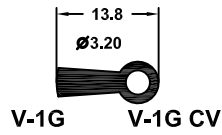
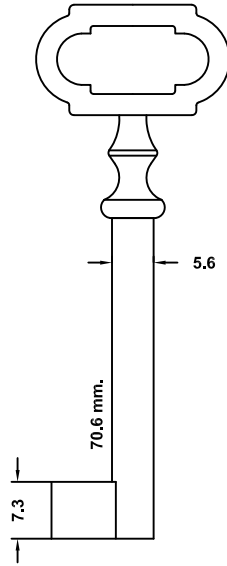
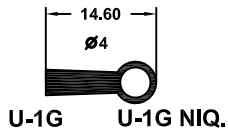
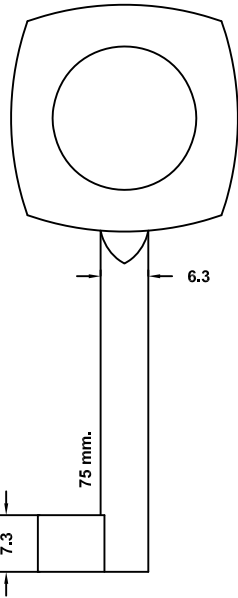
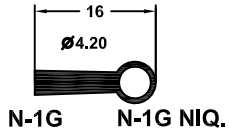
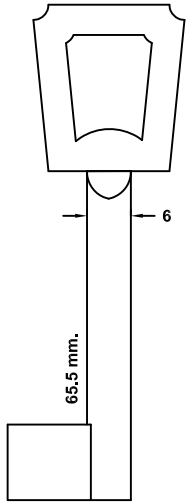

# **LLAVES ARTÍSTICAS Y DE ARMARIO ZAMAK**

ZAMAKEZKO GILTZAK: ARMAIRUETARAKO ETA ARTISTIKOAK

ZAMAK FURNITURE KEYS

CLES POUR MEUBLES EN ZAMAK

MOBELSCHLÜSSEL AUS ZAMAK



**THE KEY TO EXCELLENCE**  
GLOBALLY UNLOCKING MILLIONS OF DOORS DAILY



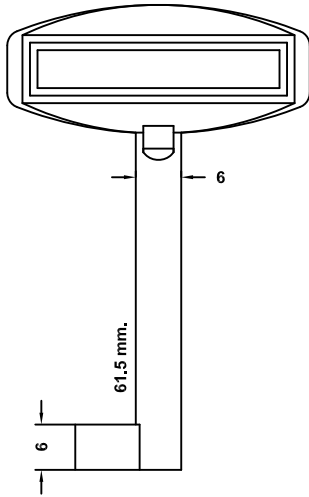

A1 LAT. A1 NIQ.

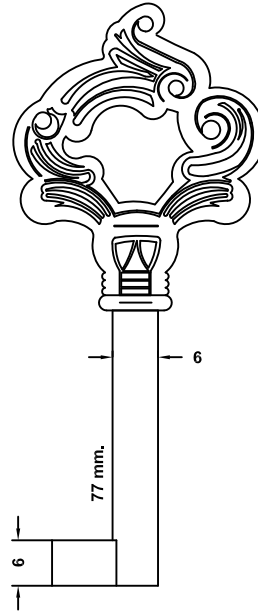

F1 LAT.



# ***LLAVES PARA CASILLAS Y ASCENSORES***

*KUTXATILA ETA IGOGAILUENTZAKO GILTZAK*

*LIFT AND MAIL BOX KEYS*

*CLES POUR ASCENSEURS ET BOITES A LETTRES*

*FACHKASTEN-UND LIFTSSCHLÜSSEL*

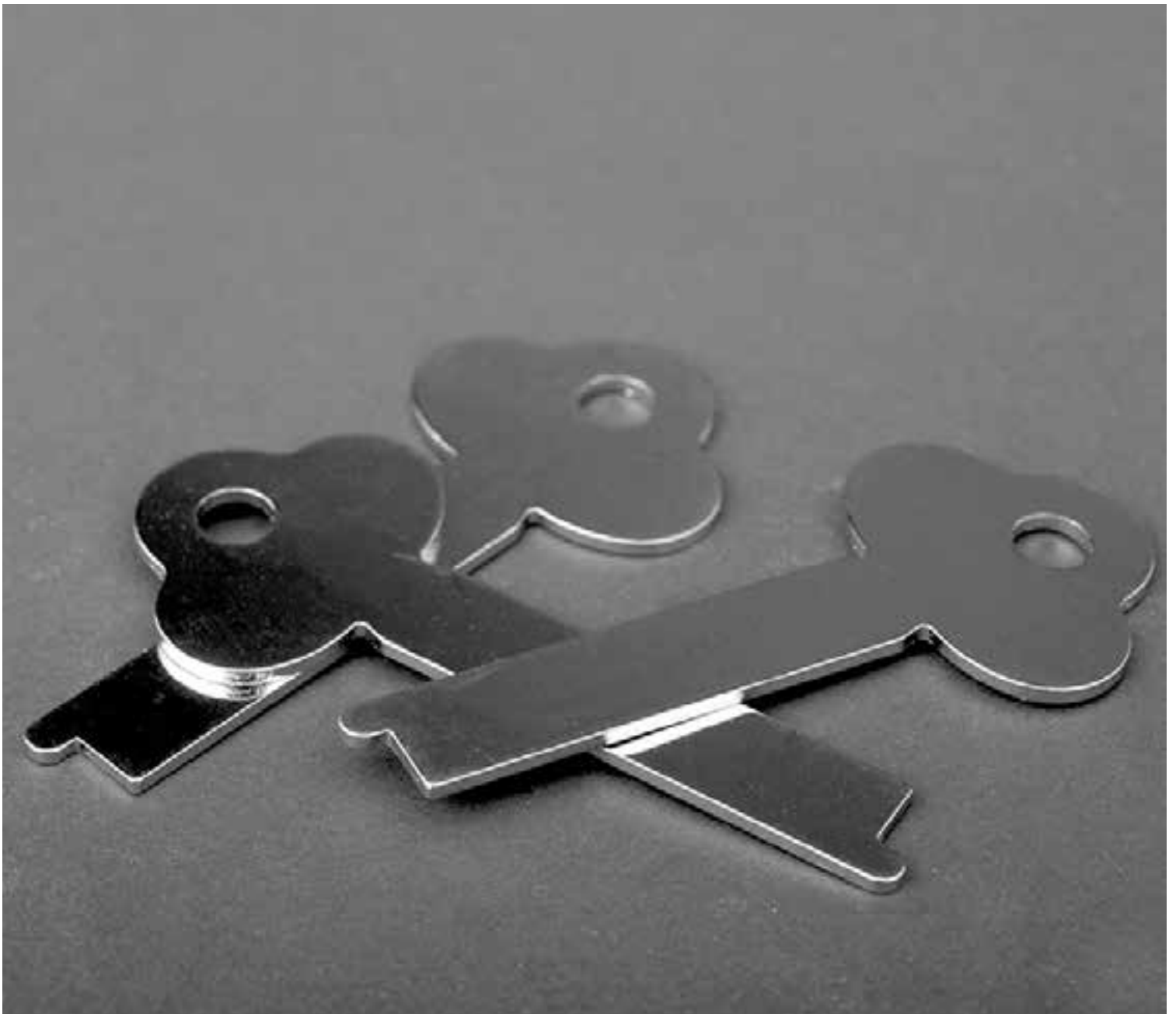

***THE KEY TO EXCELLENCE***

*GLOBALLY UNLOCKING MILLIONS OF DOORS DAILY*

**PARA-FOR:**

DIEBOLD (D)

RIL (E)

SERRETA (E)

URKO (E)

YALE (D-GB)

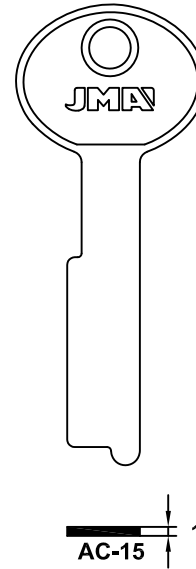
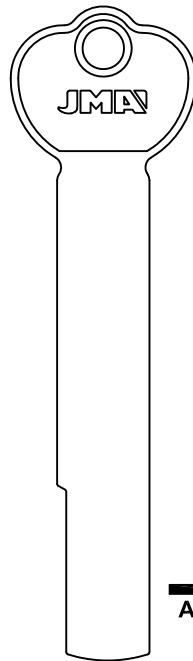
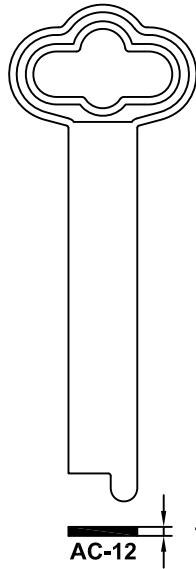
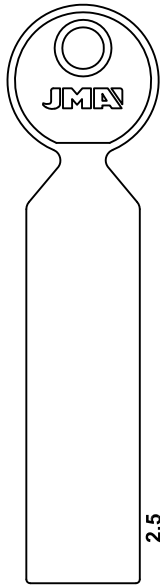

**DIEBOLD**

**RIL**

**SERRETA**

**URKO**

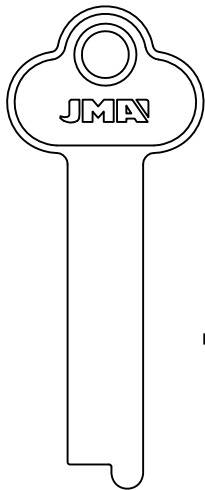

LAT.

**DIE-1**

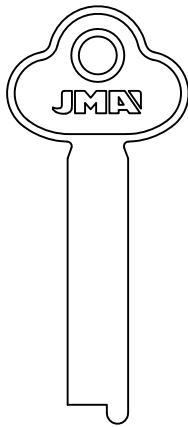

**26-M**

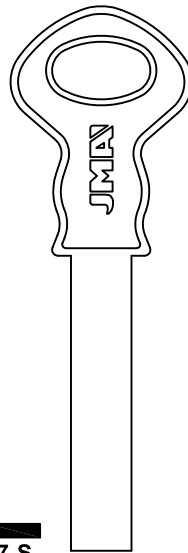

**7-S**

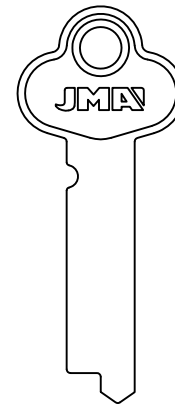

**URKO-4**

**YALE**

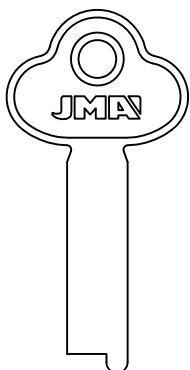

LAT.

**YA-30**





# ***AUTOMÓVIL - CAMIONETA***

*AUTOMOBILA-KAMIONETA*

*CAR-PICK UP TRUCK*

*VOITURE-CAMIONNETTE*

*AUTO-KLEINTRANSPORTER*

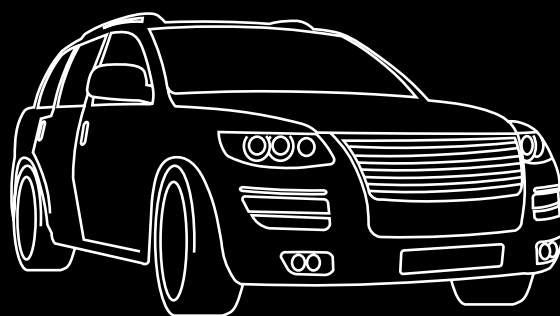

***THE KEY TO EXCELLENCE***  
*GLOBALLY UNLOCKING MILLIONS OF DOORS DAILY*









# AUTOMÓVIL - CAMIONETA



## CAR - PICK-UP TRUCKS



### AUTOMÓVIL-CAMIONETA

AUTOMOVILA-KAMIONETA • CAR-PICK-UP TRUCKS  
VOITURE-CAMIONNETTE • AUTO-KLEINTRANSPORTER

MARCA BRAND	MODELO MODEL			
ABT	GOLF 3	1991-	AU-AH	AU-AH
			AU-AHP	AU-AHP
			VO-2	VO-2
			VO-2P	VO-2P
ACM	10.1 ENDURO	-	NE-15I	RO-15
	10.4 ENDURO	-	NE-15IP	
	OFF 4WD	-		
ACURA (HONDA)	INTEGRA	-1989	HOND-10	HOND-10
	LEGEND	1989-1991	HOND-10P	HOND-10P
	MODELOS	1986-1988		
	INTEGRA	1990-	HOND-15	HOND-15
	VIGOR	1992-	HOND-15P	HOND-15P
	LEGEND	1991-	HOND-17P	HOND-17P
	NSX	1991-1997	HOND-16D HOND-16DP HOND-16DP1	HOND-16D HOND-16DP HOND-16DP1
AIXAM	500-4	-	SIX-3P	SIX-3P
	COUPE	2008		
	CROSSLINE	2007		
	CROSSOVER	2011		
	GTO	2011		
	ROADLINE	2009-2010		
	SCOUTY	2005-2012		
ALFA ROMEO	10 AR 6	-	FI-12	FI-12
	13 AR 6	-	FI-12P	FI-12P
			FI-12P3	FI-12P3
			FI-3D	FI-3D
			FI-3DP3	FI-3DP3
			FI-6I	FI-6I
	30 AR 8	-1986	AF-7I	IMS-3
	35 AR 8	-1986	AF-7IP	IMS-3P
	40 AR 8	-1986	FI-9I	IMS-5
			FI-9IP	IMS-5P
	30 AR 8	1986-	FI-2D	FI-2D
	35 AR 8	1986-	FI-2DP3	FI-2DP3
	40 AR 8	1986-	FI-3D	FI-3D
			FI-3DP1	FI-3DP1
			FI-6I	FI-6I
			FI-6IP1	FI-6IP1
	33	1983-1986	AF-14	AF-14
	164	1987-1995	AF-14P	AF-14P
	164 V6	1987-1995	FI-6I	FI-6I
			FI-6IP4	FI-6IP4
	33	1986-1990	FI-3D	FI-3D
	75 TD	1987-	FI-3DP4	FI-3DP4
	33	1990-	AF-14	AF-14
75	1990-1991	AF-14P	AF-14P	

MARCA BRAND	MODELO MODEL				
ALFA ROMEO	SZ COUPE	1991-			
	75 MILANO	1985-	AF-13	AF-13	
	90	1985-	AF-13P	AF-13P	
	SPIDER	1991-1995			
	90	1984-1985	FI-6I	FI-6I	
	145	1994	FI-6IP4	FI-6IP4	
			FI-13	FI-13	
	155	1992-1995	FI-13P	FI-13P	
			FI-14P	FI-14P	
	155 6V	1992-1995	FI-13P	FI-13P	
	155 T.S.	1992-1995	FI-14P	FI-14P	
	1750	-	AF-7I	AF-5D	
	GIULIA 1600	-	AF-7IP	AF-5I	
			NE-25	AF-6D AF-6I	
	2000 BERLINA	-	AF-7I	AF-5D	
	A 11 D	-	AF-7IP	AF-5I	
	A 12 D	-		AF-6D	
	ALFETTA 1.6 1	-		AF-6I	
	ALFETTA 1.8 1	-			
	F 11 D	-			
	F 12 D	-			
	GIULIA DIES.	-			
SPRINT	-				
2000 COUPE	-	SIP-3	AF-5D		
2000 SPIDER	-		AF-5I AF-6D AF-6I		
A 11	-	BH-8	AF-5D		
A 12	-		AF-5I		
F 11	-		AF-6D		
F 12	-		AF-6I		
A 20	-	BH-1	RO-7D		
A 38	-	BH-1P			
ALFA 6	1984-	FI-6I	AF-10		
ALFETTA	1982-1984	FI-6IP4	AF-11 AF-12		
ALFASUD	-	AF-7I	AF-5D		
		AF-7IP	AF-5I		
		FI-6I	AF-6D		
		FI-6IP4	AF-6I		
		FI-9I			
		FI-9IP			
		SIP-3			
ALFETTA	1978-1982	AF-7I	AF-10		
ALFETTA 1.6 2	-	AF-7IP	AF-11		
ALFETTA 1.6 G	-		AF-12		



MARCA BRAND	MODELO MODEL			
ALFA ROMEO	ALFETTA 1.8 2	-		
	ALFETTA 1.8 G	-		
	ALFETTA 2.0 G	-		
	GIULIETTA	1979-1981		
	ALFETTA	1984-	FI-6I	AF-10
			FI-6IP4	AF-11
				AF-12
				FI-6I
				FI-6IP4
	ARNA 1.2 L	-	FI-6I	DAT-6
	ARNA 1.2 LS	-	FI-6IP4	DAT-6P
	ARNA 1.3 TI	-		
	DUETTO	-	FI-6I	AF-5D
			FI-6IP4	AF-5I
				AF-6D
				AF-6I
	GIULIA 1300	-	AF-7I	AF-5D
			AF-7IP	AF-5I
			BH-8	AF-6D
			NE-25	AF-6I
	GIULIETTA	1981-	FI-6I	GIOB-3P
	GTV 2.0	1982-1995	FI-6IP4	
	GTV 2.0 6V	1984-1995		
GTV 2.5	1982-1995			
GTV 2.5 6V	1984-1995			
MONTREAL	-	AF-7I	IMS-3	
		AF-7IP	IMS-3P	
			IMS-5	
			IMS-5P	
SPIDER	1970-1989	AF-7I	AF-5D	
		AF-7IP	AF-5I	
		FI-6I	AF-6D	
		FI-6IP4	AF-6I	
		SIP-3		
SPIDER	1990-1991	AF-14	AF-5D	
		AF-14P	AF-5I	
			AF-6D	
			AF-6I	
SPIDER 1300	-	AF-7I	AF-5D	
		AF-7IP	AF-5I	
		BH-8	AF-6D	
			AF-6I	
AMERICAN MOTORS	ALLIANCE	1981-1983	CHR-3	NE-16
	ENCORE	1981-1983	CHR-3P	NE-59P
				VA-10
	ALLIANCE	1984-1985	CHR-3	NE-16
	ENCORE	1984-1985	NE-19	NE-59P
			NE-19P	VA-10
			NE-22P	
	ALLIANCE	1985-1986	CHR-3	BAS-1I
	ENCORE	1985-1986	NE-22P	
	ALLIANCE	1986-1988	NE-19	BAS-1I
ENCORE	1986-1988	NE-19P		



MARCA BRAND	MODELO MODEL			
AMERICAN MOTORS	CHEROKEE	-1990	BAS-1I	BAS-1I
	COMANCHE	-1990	GM-9	
	W.BASE	-1990	GM-9P	
	W.ISLANDER	-1990	GM-J	
	W.LAREDO	-1990	GM-JP	
	W.SAHARA	-1990		
	W.TEXAS	-1990		
	WAGONEER	-1990		
	CHEROKEE	1991-1992	CHR-9	CHR-9
	COMANCHE	1991-1992	CHR-9P	CHR-9P
	MJ COMANCHE	1993-	CHR-10	CHR-10
	XJ CHEROKEE	1993-	CHR-10P	CHR-10P
	YJ WRANGLER	1993-		
	ZJ G.CHEROKEE	1993-		
	MODELOS	1953-1969	BS-1I	BS-1I
	MODELOS	1970-1985	BAS-1I	BAS-1I
	WAGONEER	1991-1992	CHR-9	BAS-1I
			CHR-9P	CHR-9
			GM-9	CHR-9P
			GM-9P	
			GM-J	
			GM-JP	
	ARO DACIA	203	-	BH-1
			BH-1P	
240		1982-1985	BH-1	RO-15
			BH-1P	
240		1985-	NE-15I	RO-15
241		1985-	NE-15IP1	
242		1985-		
243		1985-		
244		1985-		
ISCHIA 10.1		1985-		
ISCHIA 10.4		1985-		
SUPER ISCHIA	1985-			
ASTON MARTIN	LAGONDA	-	FO-E-TC	FO-E-TC
	LAGONDA LIM.	-	FO-E-TCP	FO-E-TCP
	V8 SALOON	-	FO-FR	IN-1
	V8 VANTAGE	-	FO-FRP	OP-WHP
	V8 VANTAGE Z	-	OP-WHP	OP-WYP
	V8 VOLANTE	-	OP-WYP	UN-FP
	V8 VOLANTE C	-		UN-FS
			UN-FT	
AUDI	50 GL	1974-	VO-VB	VO-VB
	50 LS	1974-	VO-VBP	VO-VBP
	80 GLS	1979		
	80 GT	1979		
	60	-		
	100	1973-1977		
	100 L	1973-1977		
	100 LS	1973-1977		
	80	1978-1982	AU-1	AU-1
	100	1978-1982	AU-HV	AU-HV
	200	1978-1982	AU-HVP	AU-HVP
4000	1978-1982	VO-VB	VO-VB	









# AUTOMÓVIL - CAMIONETA

## CAR - PICK-UP TRUCKS

MARCA BRAND	MODELO MODEL			
AUDI	5000	1978-1982	VO-VBP	VO-VBP
	80	1983-1984	AU-1	AU-1
			AU-HV	AU-HV
			AU-HVP1	AU-HVP1
			VO-HV	VO-HV
			VO-VB	VO-VB
			VO-VBP	VO-VBP
	80	1984-1985	AU-AH	AU-AH
	QUATTRO	1984-1985	AU-AHP1	AU-AHP1
			AU-AN	AU-AN
			AU-ANP	AU-ANP
			VO-2	VO-2
			VO-2P	VO-2P
	80	1985-	AU-AH	AU-AH
	90	1985-	AU-AHP	AU-AHP
	100	1985-	AU-AN	AU-AN
	200	1985-	AU-ANP	AU-ANP
	4000	1985-	VO-2	VO-2
	5000	1985-	VO-2P	VO-2P
	CABRIO	1985-1995		
	COUPE	1985-1995		
	QUATTRO	1985-		
	V8	1985-		
100	1979	NE-1	AU-W	
100 GLS	1979	NE-1P		
100 L	1979			
COUPE GT	1982-1984	AU-1	AU-1	
QUATTRO	1982-1984	AU-HV	AU-HV	
		AU-HVP	AU-HVP	
		VO-HV	VO-HV	
		VO-VB	VO-VB	
		VO-VBP	VO-VBP	
FOX	1973-1977	VO-HV	VO-HV	
		VO-HVP	VO-HVP	
AUSTIN	SHERPA 185	-	LF-BL	UN-1FS
	SHERPA 230	-	LF-RO	UN-FT
	SHERPA 255	-	LF-ROP	
AUTOBIANCHI	A111	-	AF-7I	IMS-3
			AF-7IP	IMS-3P
			AF-8D	IMS-5
			AF-8DP	IMS-5P
			AF-8I	
			AF-8IP	
			AF-9D	
			AF-9DP	
			AF-9I	
			AF-9IP	
	A112	1971-1977	AF-7I	IMS-3
			AF-7IP	IMS-3P
			FI-9I	IMS-5
			FI-9IP	IMS-5P
			SIP-3	
	A112	1978-1981	AF-7I	IMS-3
			AF-7IP	IMS-3P



MARCA BRAND	MODELO MODEL			
AUTOBIANCHI			FO-FR	IMS-5
			FO-FRP	IMS-5P
	A112	1981-1984	AF-7I	IMS-3
			AF-7IP	IMS-3P
			FI-8I	IMS-5
			FI-8IP	IMS-5P
			FI-9I	
			FI-9IP	
	A112	1984-1986	FI-3D	FI-3D
			FI-3DP3	FI-3DP3
			FI-6I	FI-6I
			FI-6IP3	FI-6IP3
				IMS-3
				IMS-3P
				IMS-5
				IMS-5P
	A112 (1.SER)	1969-1971	AF-7I	IMS-3
			AF-7IP	IMS-3P
			AF-8D	IMS-5
			AF-8DP	IMS-5P
			AF-8I	
			AF-8IP	
			AF-9D	
		AF-9DP		
		AF-9I		
		AF-9IP		
		FO-FR		
		FO-FRP		
BIANCHINA	-	FEM-1D	AF-5D	
		FEM-1I	AF-5I	
		FEM-2D	AF-6D	
		FEM-2I	AF-6I	
PRIMULA	-	AF-7I		
		AF-7IP		
		FEM-1D		
		FEM-1I		
		FEM-2D		
		FEM-2I		
	Y10	1986-	FI-1	FI-1
			FI-11	FI-11
			FI-11P	FI-11P
			FI-1P	FI-1P
			FI-1P8	FI-1P8
BEDFORD	MIDI VAN	-	TOYO-14	TOYO-14
	MIDI WAGON	-	TOYO-14P	TOYO-14P
	WINDOW VAN	-		
	RASCAL	-	GM-1P	GM-1P
BELLIER	DIVANE	2004-2006	SIX-3P	SIX-3P
	JADE	2009		
	OPALE	2007-2009		
BENTLEY	CONTINENTAL	-	YA-18D	YA-18D
	EIGHT	-	YA-19D	YA-19D
	TURBO	-		
	MULSANNE	1987-	YA-20I	YA-20I



MARCA BRAND	MODELO MODEL			
<b>BENTLEY</b>			YA-21I	YA-21I
<b>BERTONE</b>	FREECLIMBER	-	DAI-1P	DAI-1P
	SL-CABRIO	-	MIT-12	MIT-12
			MIT-7	MIT-7
			MIT-7P	MIT-7P
<b>BMA</b>	AMICA 250	-	AF-9D	UN-MRN
	AMICA 360 D	-	AF-9DP	
	AMICA 50-125	-	AF-9I	
			AF-9IP	
			FEM-1I	
<b>BMW</b>	524 TD	1984-1986	BM-2	BM-2
	SERIE 7	1984-1986	BM-2P	BM-2P
			BM-HB	BM-HB
			BM-HBP	BM-HBP
	1502	1968-1976	BM-W	BM-B
	1600	1968-1976		HU-SX
	1602	1968-1976		
	1800	1968-1976		
	1802	1968-1976		
	2000	1968-1976		
	2002	1968-1976		
	2000 TOURING	1968	BM-W	BM-W
	2002 TOURING	1979		
	2500	1968-	BM-1P	BM-1P
	2800	1970-1975		
	3000	1970-1975		
	3800	1970-1975		
	BAVARIA	1970-1975		
	SERIE 3	1975-1984	BM-3	BM-3
	SERIE 5	1975-1984	BM-3P	BM-3P
	SERIE 6	1975-1984	BM-HB	BM-HB
	SERIE 7	1975-1984	BM-HBP	BM-HBP
			BM-NB	BM-NB
			BM-NBP	BM-NBP
	SERIE 3	1987-1990	BM-2	BM-2
			BM-2P	BM-2P
			BM-NB	BM-NB
			BM-NBP	BM-NBP
	SERIE 3	1990-1995	BM-4	BM-4
	SERIE 5	1988-1995	BM-5P	BM-5P
	SERIE 7	1988-1995		
	SERIE 8	1988-1995		
<b>CARBODIES</b>	FAIRWAY FX4S	-	LF-RO	IN-4
			LF-ROP	IN-5
<b>CHATENET</b>	BAROODER	2001-2010	SIX-3P	SIX-3P
	CH26	2007		
	CH28	2012		
	CH30	2010		
	CH32	2012		
	MEDIA	2000-2009		
	SPEEDINO	2006-2010		
	STELLA	-		
<b>CHRYSLER</b>	O24	1987-	CHR-8	CHR-8
	5.TH AVENUE	-	CHR-8P	CHR-8P



MARCA BRAND	MODELO MODEL			
<b>CHRYSLER</b>	FULL SIZE V.	-		
	LEBARON	1989-		
	NEW YORKER	-		
	ARROW	-	MIT-1I	MIT-1I
	D 50	-	MIT-1IP	MIT-1IP
	PICK UP	-		
	CHALLENGER	-	MIT-2I	MIT-2I
	CONQUEST	-	MIT-2IP	MIT-2IP
	RAIDER	-		
	SAPPORO	-		
	COLT	1993-	MIT-8D	MIT-8D
	VISTA	1993-	MIT-8DP	MIT-8DP
	CONCORDE	1993-	CHR-10	CHR-10
	FULL SIZE V.	1993-	CHR-10P	CHR-10P
	IMPERIAL	1993-		
	NEW YORKER	1993-		
	PICK UP	1993-		
	TOWN & CO.	1993-		
	VANS	-		
	CRICKET	-	LF-SL	LF-SL
			LF-SLP	LF-SLP
	GR. VOYAGER	1996-1997	CHR-14	CHR-14
	STRATUS	1995	CHR-14P	CHR-14P
	VIPER	1995	CHR-15	CHR-15
	VISION	1995	CHR-15P	CHR-15P
	VOYAGER	1995		
	LEBARON VAN.	-	CHR-7	CHR-7
	MOD. USA	1967-1979	CHR-7P	CHR-7P
	MOD. USA	1980-1986		
	OMNI-HORIZON	-		
	RELIANT	1989-		
	TC3-ARIES	-		
	MOD. USA	1990-1992		
<b>CHRYSLER (DODGE)</b>	1800	-		
	400	1985-	CHR-7	CHR-7
	DODGE	1985-1986	CHR-7P	CHR-7P
	RAM 50	-		
	600 CARAVEL.	1985-1989	CHR-8	CHR-8
	CARAVAN	1991-1993	CHR-8P	CHR-8P
	DAKOTA	1991-1993		
	DAYTONA	1991-1993		
	DODGE	1986-1990		
	LANCER	-		
	RAM	1986-		
	SHADOW ES	1991-1992		
	TRAIL DUSTER	1986-		
	CARAVAN	1993-	CHR-10	CHR-10
	DAKOTA	1993-	CHR-10P	CHR-10P
	DAYTONA	1993-		
	INTREPID	1993-		
	RAMCHARGER	1993-		
	SPIRIT	1993-		
	VIPER	1993-		
	COLT	1989-1993	CHR-17	CHR-17



# AUTOMÓVIL - CAMIONETA

## CAR - PICK-UP TRUCKS

MARCA BRAND	MODELO MODEL				
CHRYSLER (DODGE)	VISTA	1989-1992	MIT-12 MIT-7 MIT-7P	MIT-12 MIT-7 MIT-7P	
	COLT	1993-	MIT-13D	MIT-13D	
	VISTA	1993-	MIT-14D MIT-8D MIT-8DP	MIT-14D MIT-8D MIT-8DP	
	DODGE	-	CHR-7	CHR-7	
	RAMCHARGER	1981-1992	CHR-7P CHR-8 CHR-8P	CHR-7P CHR-8 CHR-8P	
	DODGE	1991-	CHR-9	CHR-9	
	NEON	1995	CHR-9P	CHR-9P	
	SPIRIT	1990-1992			
	VIPER	1990-1992			
	DODGE 400	1989-	CHR-7 CHR-7P		
	DODGE 600	1989-	CHR-8 CHR-8P		
	MONACO	1990-1993		VA-10	
	STEALTH	1991-1993	MIT-12 MIT-7 MIT-7P	MIT-12 MIT-7 MIT-7P	
	CHRYSLER (EAGLE)	D 50	-	MIT-11	MIT-11
		EAGLE	-	NE-19	NE-28
		MEDALLION	-	NE-19P	VA-10
EAGLE		1989-1990	MIT-12 MIT-7 MIT-7P	MIT-12 MIT-7 MIT-7P	
EAGLE		1990-1992		VA-10	
PREMIER		1990-			
EAGLE		1993-	MIT-8D MIT-8DP	MIT-8D MIT-8DP	
SUMMIT		1989-1992	CHR-17	CHR-17	
TALON		1989-	MIT-12 MIT-7 MIT-7P	MIT-12 MIT-7 MIT-7P	
SUMMIT		1993-	MIT-13D MIT-14D MIT-8D MIT-8DP	MIT-13D MIT-14D MIT-8D MIT-8DP	
VISION		1993-1998	CHR-10 CHR-10P	CHR-10 CHR-10P	
CHRYSLER (PLYMOUTH)		ACCLAIM	1990-1992	CHR-9	CHR-9
		PLYMOUTH	1990-	CHR-9P	CHR-9P
		ACCLAIM	1993-	CHR-10	CHR-10
		GRAN VOYAGER	1993-	CHR-10P	CHR-10P
		VOYAGER	1993-		
	COLT VISTA	1989-1992	CHR-17	CHR-17	
	LASER	1989-1992			
	COLT VISTA	1993-1994	MIT-13D MIT-14D	MIT-13D MIT-14D	
	NEON	1995	CHR-14 CHR-14P	CHR-14 CHR-14P	



MARCA BRAND	MODELO MODEL			
CHRYSLER (PLYMOUTH)			CHR-15 CHR-15P	CHR-15 CHR-15P
	PLYMOUTH	1985-1986	CHR-7 CHR-7P	CHR-7 CHR-7P
	PLYMOUTH	1986-1990	CHR-8	CHR-8
	SUNDANCE	1989-	CHR-8P	CHR-8P
	VOYAGER	1991-1992		
	CITROEN	2 CV	1970-	CT-3 CT-3P CT-4P
ACADIANE		-	CT-2P1 CT-3 CT-3P	RO-4D RO-4I
AMI 6		1969-	CT-3	RO-5D
AMI 8		1969-	CT-3P	RO-5I
SM		1970-		
AX		1986-1989	CL-8P	CL-8P
BX		1982-1990	SIX-1 SIX-1P SIX-2 SIX-2P	SIX-1 SIX-1P SIX-2 SIX-2P
AX		1989-1994	NE-36 NE-36P1 SIX-1 SIX-1P SIX-2 SIX-2P	NE-36 NE-36P1 SIX-1 SIX-1P SIX-2 SIX-2P
AX		1994	NE-20P3	NE-20P3
ZX		1994	NE-36	NE-36
AX		1995	SIX-3P2	SIX-3P2
ZX		1995		
AX 14D COME.		-	SIX-1 SIX-1P1	SIX-1 SIX-1P1
AXEL		1984-	CHR-3 CHR-3P NE-22P1	CHR-3 CHR-3P NE-22P1
BERLINGO		1997	SIX-3P1	SIX-3P1
EVASION		1994		
JUMPI		1996-		
BX		1990-	NE-36 NE-36P1 SIX-1 SIX-1P SIX-2 SIX-2P	NE-36 NE-36P1 SIX-1 SIX-1P SIX-2 SIX-2P
C-15 D		-	SIX-1	SIX-1
C-15 E		-	SIX-1P	SIX-1P
VISA		1985-		
ZX		1991-1992		
C-25 FURGON.		-	FI-6I FI-6IP3	FI-6I FI-6IP3
CX		1974-1985	CT-3 CT-3P	AB-5D AB-5I RO-5D



MARCA BRAND	MODELO MODEL			
CITROEN				RO-5I
	CX	1985-	SIX-1 SIX-1P SIX-2 SIX-2P	SIX-1 SIX-1P SIX-2 SIX-2P
	D	-1974	CT-1	RO-5D
	DS	-1974	CT-1P	RO-5I
			CT-3	
			CT-3P	
	DYANE	1967-1980	CT-2	RO-4D
			CT-2P	RO-4I
			CT-2P1	
			CT-3 CT-3P	
	DYANE	1980-	SIX-1	RO-4D
			SIX-1P	RO-4I
			SIX-2	
			SIX-2P	
	G	1970-	CT-3	AB-5D
	GS	1970-	CT-3P	RO-5D
	GSA	1970-		RO-5I
	JUMPER	1996-	FI-11P	FI-11P
	LN	1976-1984	NE-4	VA-6
	LNA	1976-1984	NE-4P1	VA-6P
	LNA	1984-	CHR-3	VA-6
CHR-3P			VA-6P	
NE-22P1				
MEHARI	1968-	CT-3	RO-4D	
		CT-3P	RO-4I	
		CT-4P		
PLUS	-	FI-12	FI-12	
		FI-12P	FI-12P	
		FI-12P3	FI-12P3	
		FI-3D	FI-3D	
		FI-3DP3	FI-3DP3	
SAXO	1996	SIX-3P	SIX-3P	
SYNERGIE	1994-1997			
XANTIA	1993-			
XM	1990-			
VISA	1979-1985	CHR-3	RO-4D	
		CHR-3P	RO-4I	
		NE-22P1	RO-5D	
		NE-4	RO-5I	
		NE-4P1		
ZX	1992-1994	SIX-1P2	SIX-1P2	
DAEWOO	DAMA	-	DAE-1P	DAE-1P
	LANOS	1997	DAE-4P1	DAE-4P1
	LE MANS	1973-1982	OP-6	OP-6
			OP-7	OP-7
			OP-8	OP-8
			OP-9	OP-9
			OP-BB	OP-BB
OP-EE	OP-EE			



MARCA BRAND	MODELO MODEL			
DAEWOO			OP-FF	OP-FF
	LE MANS	1983-1984	OP-D	OP-D
			OP-DP	OP-DP
			OP-S	OP-S
			OP-SP	OP-SP
	LE MANS	1985-	OP-AB	OP-AB
			OP-ABP	OP-ABP
			OP-BA	OP-BA
			OP-BAP	OP-BAP
			OP-J	OP-J
LEGANZA	1997	DAE-4D	DAE-4D	
		DAE-4DP1	DAE-4DP1	
NUBIRA	1997-2000	DAE-3D	DAE-3D	
TACUMA	2000-2002	DAE-3DP1	DAE-3DP1	
RACER	-	DAE-2DP	DAE-2DP	
DAF	46 L	-		FO-TC
	46 STATIONCA	-		
	46 SUPER L	-		
	66 GL	-		
	66 COUPE	-		
	66 L	-		
	66 MARATHON	-		
	66 SL	-		
	66 STATIONCA	-		
	95 XF	1997	CHR-3P	CHR-3P
DAIHATSU	4 WD TURBO	-	TOYO-K1	
	PIONEER 2800	-	TOYO-K1P	
	TAFT 1600 D.	-		
	TAFT F10	-		
	TAFT F20	-		
	TAFT F201600	-		
	TAFT F50	-		
	TAFT F55	-		
	APPLAUSE	1990-	DAI-1P	DAI-1P
	CHARADE	1990-		
	FEROZA	1988-		
	ROCKY	1990-		
	SPORTTRACK	1991-		
	SX 228	1991-		
CHARADE	1977-1983	TOYO-K1	TOYO-K1	
CHARMANT	1983-	TOYO-K1P	TOYO-K1P	
CUORE L55	1976-1998			
CUORE L60	1976-1998			
MIRA	1976-			
CHARADE	1983-1989	TOYO-3	TOYO-3	
FOURTRAK 4WD	1984-1988	TOYO-3P	TOYO-3P	
ROCKY	1984-1988	TOYO-8	TOYO-8	
		TOYO-8P	TOYO-8P	
CUORE 850	1986-1991	TOYO-3	TOYO-3	
ROCKY	1989-1990	TOYO-3P	TOYO-3P	
DAIMLER	DOUBLE SIX C	-1987	FO-FR	CENT-3D
	LIMOUSINE	-1987	FO-FRP	FO-5
	SOVEREIGN V.	-1987		



# AUTOMÓVIL - CAMIONETA

## CAR - PICK-UP TRUCKS

MARCA BRAND	MODELO MODEL			
DAIMLER	SOVEREIGN3.4	-1987		
	SOVEREIGN4.2	-1987		
	MODELOS	1990-1994	JAU-1P	JAU-1P
DE LOREAN	MODELOS	1980-1981	NE-10	LF-WR
			NE-10P	
DELTA MOTOR	CRUISER	-	TOYO-K1	TOYO-K1
	MINI WHEEL	-	TOYO-K1P	TOYO-K1P
	EXPLORER	-	TOYO-K1	DAT-6
			TOYO-K1P	DAT-6P
DISALCAR	IN 32 4X4	-	AF-7I	IMS-3
	IN 50 R 4X4	-	AF-7IP	IMS-3P
	IN 60 4X4	-		IMS-5
	IN 70 B 4X4	-		IMS-5P
	IN 70 CR 4X4	-		
	R 26 4x4	-	BH-4	
EBRO	F 275	-	LMP-1	IMS-3
	F 350	-	LMP-1P	IMS-3P
			STS-2D	IMS-5
			STS-2DP	IMS-5P
	L 35	-	LMP-1	CL-2I
	L 35/1	-	LMP-1P	CL-3I
	L 60	-	NE-3	FO-OA
	L 80	-	NE-3P	FO-PN
			NE-3P1	
			NE-3P2	
	PATROL	1983-	DAT-6	DAT-6
	VANETTE	1983-	DAT-6P	DAT-6P
	TRADE 2.0	1983-	STS-2D	IMS-3
	TRADE 2.8	1983-	STS-2DP	IMS-3P
			IMS-5	
			IMS-5P	
FERRARI	208	1975-1982	NE-25	IMS-3
	308	1973-1975		IMS-3P
	365	1968-		IMS-5
	DINO 246	-		IMS-5P
	208	1982-	NE-25	AF-5D
	308	1975-		AF-5I
	328	1985-		AF-6D
				AF-6I
	208 GTS	1982	AF-7IP1	
	348	1984-	FI-6I	FI-6I
	F 40	1984-	FI-6IP	FI-6IP
	MONDIAL	1984-	FI-6IP2	FI-6IP2
	TESTA ROSSA	1984-	FI-6IP3	FI-6IP3
	400	1976-	HU-1	AF-5D
	412	1976-	NE-25	AF-5I
	BB 512	1976-		AF-6D
				AF-6I
	GTO	1984	NE-25	AF-6D
	MONDIAL 8	1982	AF-7I	AF-5D
		AF-7IP	AF-5I	
		AF-7IP1	AF-6D	
			AF-6I	
FIAT	124	1966-	AF-7I	IMS-3



MARCA BRAND	MODELO MODEL			
FIAT			AF-7IP	IMS-3P
			AF-9D	IMS-5
			AF-9DP	IMS-5P
			FEM-1D	
			FEM-1I	
			FEM-2D	
			FEM-2I	
			FO-FR	
			FO-FRP	
			SIP-2	
	125	-	AF-7I	IMS-3
			AF-7IP	IMS-3P
			AF-9D	IMS-5
			AF-9DP	IMS-5P
		FO-FR		
		FO-FRP		
126	-	AF-7I	IMS-3	
		AF-7IP	IMS-3P	
		AF-9D	IMS-5	
		AF-9DP	IMS-5P	
		FI-3D		
		FI-3DP2		
		FI-9I		
		FI-9IP		
		FO-FR		
		FO-FRP		
		SIP-3		
126 BIS	1987-1992	FI-3D	IMS-3	
126 UP	1987-1992	FI-3DP2	IMS-3P	
		FI-3DP3	IMS-5	
		FI-6I	IMS-5P	
		FI-6IP2		
127	1973-	AF-7I	IMS-3	
		AF-7IP	IMS-3P	
		FI-8I	IMS-5	
		FI-8IP	IMS-5P	
		FI-9I		
		FI-9IP		
		FO-FR		
		FO-FRP		
		SIP-3		
127	1983-	AF-7IP1		
		FI-8IP1		
128	1969-	AF-7I	IMS-3	
		AF-7IP	IMS-3P	
		AF-9D	IMS-5	
		AF-9DP	IMS-5P	
		FI-9I		
		FI-9IP		
		FO-FR		
		FO-FRP		
		SIP-2		
		SIP-3		
130	1969-	AF-7I	IMS-3	



MARCA BRAND	MODELO MODEL			
FIAT			AF-7IP	IMS-3P
			SIP-3	IMS-5
				IMS-5P
	131	1973-1980	AF-7I	IMS-3
			AF-7IP	IMS-3P
			AF-8I	IMS-5
			AF-8IP	IMS-5P
			AF-9I	
			AF-9IP	
	131	1981-	FI-2D	FI-3D
		FI-2DP3	FI-3DP2	
		FI-3D	FI-6I	
		FI-3DP2	FI-6IP	
		FI-6I		
		FI-6IP		
132	1973-	AF-7I	IMS-3	
		AF-7IP	IMS-3P	
		FI-8I	IMS-5	
		FI-8IP	IMS-5P	
147	1976-	FI-8I	IMS-3	
148	1976-	FI-8IP	IMS-3P	
		FI-8IP1	IMS-5	
		FI-9I	IMS-5P	
		FI-9IP		
500	1964-	AF-9D	AF-5D	
		AF-9DP	AF-5I	
		FEM-1D	AF-6D	
		FEM-1I	AF-6I	
		FEM-2D		
		FEM-2I		
		FO-FR		
		FO-FRP		
600	1955-	FEM-1D	AF-5D	
1300	-	FEM-1I	AF-5I	
		FEM-2D	AF-6D	
		FEM-2I	AF-6I	
850	1964-	AF-7I	AF-5D	
		AF-7IP	AF-5I	
		FEM-1D	AF-6D	
		FEM-1I	AF-6I	
		FEM-2D		
		FEM-2I		
		FO-FR		
		FO-FRP		
		NE-3		
		NE-3P		
		NE-3P2		
1100	1956-	FEM-1D	AF-4D	
		FEM-1I	AF-4I	
		FEM-2D	AF-5D	
		FEM-2I	AF-5I	
			AF-6D	
			AF-6I	



MARCA BRAND	MODELO MODEL			
FIAT	1500	1967-	FEM-1D	AF-5D
			FEM-1I	AF-5I
			FEM-2D	AF-6D
			FEM-2I	AF-6I
			SIP-2	
	1800	1967-	SIP-2	AF-5D
	2100	1967-		AF-5I
	2300	1967-		AF-6D
				AF-6I
	ARGENTA	1981-	FI-2D	FI-2D
		FI-2DP3	FI-2DP3	
		FI-3D	FI-3D	
		FI-3DP2	FI-3DP2	
CINQUECENTO	1992-1997	FI-11	FI-11	
DUCATO	1994	FI-11P	FI-11P	
COUPE	1994-1995	FI-13	FI-13	
TIPO	1988-	FI-13P	FI-13P	
CROMA	1985-1995	FI-10	FI-11	
		FI-10P	FI-11P	
		FI-11		
		FI-11P		
DINO	-	FO-FR	IMS-3	
		FO-FRP	IMS-3P	
		SIP-2	IMS-5	
			IMS-5P	
DUNA	1987-1991	FI-1	FI-1	
PANDA	1986-1991	FI-1P	FI-1P	
RITMO	1984-1986			
STRADA	1984-1986			
DUNA	1992-	FI-1	FI-1	
PANDA	1992-1995	FI-11	FI-11	
UNO	1983-	FI-11P	FI-11P	
		FI-1P	FI-1P	
FIORINO	-	AF-7I	IMS-3	
		AF-7IP	IMS-3P	
		AF-9D	IMS-5	
		AF-9DP	IMS-5P	
		AF-9I		
		AF-9IP		
		FI-8I		
		FI-8IP		
		FI-9I		
		FI-9IP		
PANDA	1980-1985	FI-7I	IMS-3	
		FI-8I	IMS-3P	
		FI-8IP	IMS-5	
		FI-8IP1	IMS-5P	
		FI-9I		
		FI-9IP		
PUNTO	1993-1995	FI-13	FI-13	
		FI-13P1	FI-13P1	
REGATA	1983-	FI-1	FI-1	
		FI-10	FI-11	
		FI-10P	FI-11P	



# AUTOMÓVIL - CAMIONETA

## CAR - PICK-UP TRUCKS

MARCA BRAND	MODELO MODEL			
FIAT			FI-11	FI-1P
			FI-11P	
			FI-1P	
	RITMO	1978-1983	FI-3D	FI-3D
			FI-3DP	FI-3DP
			FI-3DP2	FI-3DP2
			FI-6I	FI-6I
			FI-6IP	FI-6IP
	SCUDO	1995-1997	SIX-3P1	SIX-3P1
	ULYSSE	1994		
	SPIDER EURO.	-	AF-7I	AF-5D
			AF-7IP	AF-5I
				AF-6D
				AF-6I
	STRADA	1979-1982	FI-7I	FI-7I
			FI-8I	FI-8I
			FI-8IP	FI-8IP
	STRADA	1982-1984	FI-3D	FI-3D
			FI-3DP	FI-3DP
			FI-6I	FI-6I
		FI-6IP	FI-6IP	
TEMPRA	1989-1995	FI-13	FI-13	
		FI-13P	FI-13P	
		FI-14P	FI-14P	
X 1/9	1972-	AF-7I	IMS-3	
		AF-7IP	IMS-3P	
			IMS-5	
			IMS-5P	
FIAT (ARGENTINA)	128	-	NE-4	NE-46
			NE-4P	
	133	-	NE-3	
	600	-	NE-3P	
			NE-3P2	
	147	-	NE-4	
			NE-4P	
	DUNA	1987-1991	FI-1	FI-1
			FI-1P	FI-1P
	DUNA	1992-	FI-1	FI-1
	UNO	1983-	FI-11	FI-11
			FI-11P	FI-11P
			FI-1P	FI-1P
	REGATTA	1983-	FI-1	FI-1
			FI-10	FI-11
			FI-10P	FI-11P
			FI-11	FI-1P
			FI-11P	
			FI-1P	
	SPAZIO	-	AF-7I	IMS-3
		AF-7IP	IMS-3P	
		FI-8I	IMS-5	
		FI-8IP	IMS-5P	
		FI-9I		
		FI-9IP		

MARCA BRAND	MODELO MODEL			
FIAT (ARGENTINA)			FO-FR	
			FO-FRP	
			SIP-3	
	TEMPRA	-	FI-13	FI-13
		FI-13P	FI-13P	
FIAT (BRASIL)	ELBA	1992-	FI-1	FI-1
	PREMIO	1992-	FI-11	FI-11
	UNO	1983-	FI-11P	FI-11P
		FI-1P	FI-1P	
	PALIO	1996-1997	FI-13P7	FI-13P7
FIAT (TURQUIA)	131	1973-1980	AF-7I	IMS-3
			AF-7IP	IMS-3P
			AF-8I	IMS-5
			AF-8IP	IMS-5P
			AF-9I	
			AF-9IP	
	131	1981-	FI-2D	FI-3D
			FI-2DP3	FI-3DP2
			FI-3D	FI-6I
			FI-3DP2	FI-6IP
			FI-6I	
			FI-6IP	
	SERCE	-	AF-7I	IMS-3
			AF-7IP	IMS-3P
			AF-9D	IMS-5
			AF-9DP	IMS-5P
		FEM-1D		
		FEM-1I		
		FEM-2D		
		FEM-2I		
		FO-FR		
		FO-FRP		
		SIP-2		
TEMPRA	1989-	FI-13	FI-13	
		FI-13P	FI-13P	
		FI-14P	FI-14P	
FIAT IVECO	131 D MAR.	1976-	AF-7I	IMS-3
			AF-7IP	IMS-3P
				IMS-5
				IMS-5P
	180	-1989		
	190	-1989		
	238	-	AF-7I	AF-5D
			AF-7IP	AF-5I
			AF-9D	AF-6D
			AF-9DP	AF-6I
		AF-9I		
		AF-9IP		
900 E	1980-	FI-8I	AF-5D	
		FI-8IP	AF-5I	
			AF-6D	
			AF-6I	
900 T	1976-	AF-7I	AF-5D	



MARCA BRAND	MODELO MODEL			
FIAT IVECO			AF-7IP	AF-5I
			AF-8D	AF-6D
			AF-8DP	AF-6I
			AF-8I	
			AF-8IP	
			AF-9D	
			AF-9DP	
			AF-9I	
			AF-9IP	
	DAILY 30	-1984	AF-7I	IMS-3
	DAILY 35	-1984	AF-7IP	IMS-3P
	DAILY 40	-1984	FI-9I	IMS-5
	DAILY 50	-1984	FI-9IP	IMS-5P
	DAILY 30	1985-1988	FI-2D	FI-2D
	DAILY 35	1985-1988	FI-2DP3	FI-2DP3
	DAILY 40	1985-1988	FI-3D	FI-3D
	DAILY 50	1985-1988	FI-3DP1	FI-3DP1
			FI-6I	FI-6I
			FI-6IP1	FI-6IP1
	DAILY 30	1989-1991	FI-11	FI-11
	DAILY 35	1989-1991	FI-11P	FI-11P
	DAILY 40	1989-1991		
	DAILY 45	1989-1991		
	DAILY 49	1989-1991		
	DAILY 50	1989-1991		
	FIORINO	1988-1996		
	MARENGO R.	1985-1996		
	PANDA	-1994		
	PENNY	-1991		
	UNO	-1991		
	DUCATO 10	-1988	FI-12	FI-12
	DUCATO 13	-1988	FI-12P1	FI-12P1
DUCATO MAXI	-1988	FI-12P3	FI-12P3	
		FI-3D	FI-3D	
		FI-3DP3	FI-3DP3	
		FI-6I	FI-6I	
		FI-6IP3	FI-6IP3	
DUCATO 10	1989-1996	FI-3D	FI-3D	
DUCATO 14	1989-1996	FI-3DP3	FI-3DP3	
DUCATO 4x4	1989-1996	FI-6I	FI-6I	
DUCATO MAX	1989-1996	FI-6IP3	FI-6IP3	
FIORINO	-1982	AF-9D	IMS-3	
		AF-9DP	IMS-3P	
		AF-9I	IMS-5	
		AF-9IP	IMS-5P	
		FI-9I		
		FI-9IP		
FIORINO	1983-1987	AF-7I	IMS-3	
		AF-7IP	IMS-3P	
		FI-8IP1	IMS-5	
		FI-9I	IMS-5P	
		FI-9IP		
TALENTO	-	FI-6I	FI-6I	
		FI-6IP	FI-6IP	



MARCA BRAND	MODELO MODEL			
FORD	CAPRI	-	FO-E-TC	FO-E-TC
			FO-E-TCP	FO-E-TCP
			FO-TC	FO-TC
			FO-TX	FO-TX
			FO-TXP	FO-TXP
				FO-XR
	CARGO	-	LF-WR	LF-WR
			NE-11	
			NE-11P	
			NE-24	
			NE-24P	
	CARGO	1987-1990	NE-11	LF-WR
			NE-11P	
	CARGO	1990-	NE-11	NE-11
			NE-11P	NE-11P
	CONSUL	-	FO-E-TC	FO-E-TC
	CORTINA	-	FO-E-TCP	FO-E-TCP
			FO-TC	FO-TC
				FO-XR
	ESCORT	-1986	FO-E-TC	FO-E-TC
	FIESTA	-1988	FO-E-TCP	FO-E-TCP
			FO-TC	FO-TC
			FO-TX	FO-TX
			FO-TX1	FO-TX1
			FO-TX1P	FO-TX1P
			FO-TX2	FO-TX2
			FO-TX2P	FO-TX2P
			FO-TXP	FO-TXP
	ESCORT	1986-1988	FO-4P	FO-4P
	GRANADA	1986-		
	ORION	1986-1988		
	SCORPIO	1986-1988		
SIERRA	1986-1988			
ESCORT	1989-1995	FO-6P	FO-6P	
FIESTA	1988-1995			
MONDEO	1993-1995			
ORION	1988-			
SCORPIO	1988-1990			
SCORPIO	1990-1995			
SIERRA	1988-1990			
SIERRA	1990-			
ESCORT VAN	-	FO-E-TC	FO-E-TC	
		FO-E-TCP	FO-E-TCP	
		FO-TX	FO-TX	
		FO-TXP	FO-TXP	
GRANADA	-1986	FO-E-TC	FO-E-TC	
ORION	-1986	FO-E-TCP	FO-E-TCP	
SIERRA	-1986	FO-TX	FO-TX	
		FO-TX1	FO-TX1	
		FO-TX1P	FO-TX1P	
		FO-TX2	FO-TX2	
		FO-TX2P	FO-TX2P	
		FO-TXP	FO-TXP	









# AUTOMÓVIL - CAMIONETA

## CAR - PICK-UP TRUCKS

MARCA BRAND	MODELO MODEL			
FORD	MAVERICK	1993-1995	FO-10P	FO-10P
	PROBE	1993-1996	FO-9D	FO-9D
			FO-9DP	FO-9DP
	TAURUS	-	FO-E-TC	FO-E-TC
			FO-E-TCP	FO-E-TCP
	TRANSIT 100D	-	FO-TC	FO-PRL
	TRANSIT F.	-1986	FO-E-TC	UN-FT
			FO-E-TCP	UN-TF
			FO-TX	
			FO-TX1	
			FO-TX1P	
			FO-TX2	
			FO-TX2P	
			FO-TXP	
		TRANSIT F.	1986-	FO-22P
			FO-4P	FO-4P
FORD (ARGENTINA)	ESCORT	-1986	FO-E-TC	FO-E-TC
			FO-E-TCP	FO-E-TCP
			FO-TC	FO-TC
			FO-TX	FO-TX
			FO-TX1	FO-TX1
			FO-TX1P	FO-TX1P
			FO-TX2	FO-TX2
			FO-TX2P	FO-TX2P
			FO-TXP	FO-TXP
	ESCORT	1986-1988	FO-4P	FO-4P
	SIERRA	1986-1988		
	ESCORT	1988-1995	FO-6P	FO-6P
	FIESTA	1995-1996		
	MONDEO	1995-1996		
	SIERRA	1988-1990		
	SIERRA	1990-		
	ESCORT VAN	-	FO-E-TC	FO-E-TC
			FO-E-TCP	FO-E-TCP
			FO-TX	FO-TX
			FO-TXP	FO-TXP
FALCON	-	FO-2	FO-2	
PICK UP	-1993			
GALAXI	1996	FO-17P	FO-17P	
GALAXY	-1996	FO-FHP	FO-FHP	
		VO-HV	VO-HV	
		VO-HVP	VO-HVP	
PICK UP	1993-1994	FO-3D	FO-3D	
		FO-3DP	FO-3DP	
		VO-HV		
		VO-HVP		
PICK-UP	1995-1996	FO-11D	FO-11D	
SIERRA	-1986	FO-E-TC	FO-E-TC	
		FO-E-TCP	FO-E-TCP	
		FO-TX	FO-TX	
		FO-TX1	FO-TX1	
		FO-TX1P	FO-TX1P	
		FO-TX2	FO-TX2	



MARCA BRAND	MODELO MODEL			
FORD (ARGENTINA)			FO-TX2P	FO-TX2P
			FO-TXP	FO-TXP
	TAURUS	-	FO-TX	FO-TX
			FO-TXP	FO-TXP
FORD (AUSTRALIA)	CAPRI	-1978	FO-D	FO-TC
			FO-TC	FO-XL
	CAPRI	1978-	FO-2	FO-2
			FO-TX	FO-TX
			FO-TXP	FO-TXP
	EXPLORER	1996-1997	FO-15D	FO-15D
	TAURUS	1996-1997	FO-15DP	FO-15DP
	TAURUS WAGON	1996-1997		
	FESTIVA	1993-1994	KI-1D	KI-1D
			KI-1DP	KI-1DP
	FESTIVA	1994	FO-12	FO-12
			FO-12P	FO-12P
	LASER	1988-1990	FO-14DP	FO-14DP
	LASER	1990-1993	FO-13DP	FO-13DP
	TELSTAR	-	MAZ-2D	MAZ-2D
		MAZ-2DP	MAZ-2DP	
FORD (BRASIL)	CORCEL	-	FO-3D	FO-3D
	DEL REY	-	FO-3DP	FO-3DP
	ESCORT	-1986	FO-E-TC	FO-E-TC
			FO-E-TCP	FO-E-TCP
			FO-TC	FO-TC
			FO-TX	FO-TX
			FO-TX1	FO-TX1
			FO-TX1P	FO-TX1P
			FO-TX2	FO-TX2
			FO-TX2P	FO-TX2P
			FO-TXP	FO-TXP
	ESCORT	1986-1988	FO-4P	FO-4P
	ESCORT	1988-1995	FO-6P	FO-6P
	ESCORT VAN	-	FO-E-TC	FO-E-TC
	SIERRA	-	FO-E-TCP	FO-E-TCP
VERONA	-	FO-TX	FO-TX	
		FO-TXP	FO-TXP	
PICK-UP	1995-1996	FO-3P	FO-3P	
VARIOS	1996-	FO-17P	FO-17P	
FORD (SOUTH AFRICA)	SAPPHIRE	1990-	FO-6P	FO-6P
	SIERRA	1988-1990		
	SIERRA	1990-		
	SIERRA	-1986	FO-E-TC	FO-E-TC
			FO-E-TCP	FO-E-TCP
			FO-TX	FO-TX
		FO-TX1	FO-TX1	
		FO-TX1P	FO-TX1P	
		FO-TX2	FO-TX2	
		FO-TX2P	FO-TX2P	
		FO-TXP	FO-TXP	
SIERRA	1986-1988	FO-4P	FO-4P	
FORD (USA)	AEROSTAR	1986-1991	FO-20D	FO-20D
			FO-8D	FO-8D
	AEROSTAR	1991-1996	FO-11D	FO-1



MARCA BRAND	MODELO MODEL			
FORD (USA)	EXPLORER	1991-1996		
	TAURUS S.	1991-1996		
	T-BIRD S.	1991-		
	AEROSTAR	1996-1997	FO-15D	FO-15D
	BRONCO PICK	1996-1997	FO-15DP	FO-15DP
	EXPLORER	1996-1997		
	TAURUS	1996-1997		
	TAURUS WAGON	1996-1997		
	ASPIRE	1994	FO-12 FO-12P	FO-12 FO-12P
	BRONCO	1967-1989	FO-2	FO-1
	CROWN	1967-1989		
	ESCORT	1981-1986		
	MUSTANG	1967-1998		
	T-BIRD	1967-1984		
	TEMPO GL	1983-1986		
	TEMPO GLS	1983-1986		
	VICTORIA	1967-1989		
	CONCOURSE	1995	FO-1	FO-1
	CONTOUR	1995-1997	FO-8D	FO-8D
	CROWN	1990-1998	FO-11D	FO-11D
	SABLE	1990-	FO-20D	FO-20D
	TAURUS	1990-1996		
	T-BIRD	1986-1991		
	TEMPO GL	1986-1991		
	TEMPO GLS	1986-1991		
	VICTORIA	1990-1998		
	ESCORT	1990-1995	FO-8D	FO-8D
	SABLE	1987-1989	FO-8DP	FO-8DP
	TAURUS	1986-1989		
	FESTIVA	1987-1989	MAZ-6D	MAZ-6D
	PROBE	1987-1989	MAZ-6DP	MAZ-6DP
	FESTIVA	1990-	FO-14DP FO-7P	
	FIESTA	-1979	FO-TC LF-SL	FO-TC LF-SL
	FIESTA	1979-1984	FO-TX	FO-TX
	MERKUR	1985-1989	FO-TXP	FO-TXP
	XR4 TI	1985-1989		
	MERKUR	1990-1992	FO-14DP	FO-14DP
	PROBE	1990-1992	FO-7P	FO-7P
	PROBE	1993-1996	FO-9D FO-9DP	FO-9D FO-9DP
	SCORPIO	1987	FO-22P FO-4P	FO-22P FO-4P
SCORPIO	1988-	FO-6P	FO-6P	
FORD (USA) (LINCOLN)	CONTINENTAL	1967-1984	FO-2	FO-1
	CONTINENTAL	1985-1991	FO-20D	FO-20D
	CONTINENTAL	1991-1998	FO-11D	FO-11D
	MARK SERIES	1985-1991	FO-11D FO-20D	FO-11D FO-20D
FORD (USA) (MERCURY)	CAPRI	1970-1971	FO-D	FO-XL
	CAPRI	1978-1983		



MARCA BRAND	MODELO MODEL				
FORD (USA) (MERCURY)	CAPRI	1972-1978	FO-E-TC FO-E-TCP FO-TC	FO-E-TC FO-E-TCP FO-TC	
	CAPRI	1983-1991	FO-2	FO-2	
	MERCURY	-1993			
	CAPRI	1991-	FO-14DP	FO-14DP	
	TRACER	1987-1990	FO-7P	FO-7P	
	COUGAR	1967-1984	FO-2	FO-1	
	MARQUIS	1967-1989			
	TOPAZ	1983-1985			
	COUGAR	1990-	FO-11D	FO-11D	
	MARQUIS	1991-	FO-20D	FO-20D	
	TOPAZ	1990-			
	G.MARQUIS	1993-1998	FO-8D	FO-8D	
	MERCURY	1993-1996	FO-8DP1	FO-8DP1	
	SABLE	1993-1996			
	MYSTIQUE	1995-1997	FO-8D	FO-8D	
	SABLE GS/LS	1996-1997	FO-15D FO-15DP	FO-15D FO-15DP	
	TRACER	1990-	FO-8D FO-8DP FO-8DP1	FO-8D FO-8DP FO-8DP1	
	FREIGHTLINER	MODELO	1970	YA-8D	YA-8D
	GM (BUICK)	3.8 P.AVENUE	1992-		GM-12
		LESABRE	1991-1996		GM-12P
REATA		1992-		GM-H	
RIVIERA		1992-1995		GM-HP	
CENTURY		1991-1997	GM-8	GM-12	
MODELOS		1981	GM-8P GM-E GM-EP	GM-12P GM-H GM-HP	
LESABRE		1996-1997		GM-14	
ROADMASTER		1996-1997		GM-14P GM-25 GM-25P	
MODELOS		1935-1966	BAS-1I	BAS-1I	
MODELOS		1966	GM-6	GM-6	
MODELOS		1967	GM-6P	GM-6P	
MODELOS		1971	GM-A	GM-A	
MODELOS		1975	GM-AP	GM-AP	
MODELOS		1986			
MODELOS		1968	GM-7	GM-7	
MODELOS		1972	GM-7P GM-C GM-CP	GM-7P GM-C GM-CP	
MODELOS		1969	GM-8	GM-8	
MODELOS		1973	GM-8P GM-E GM-EP	GM-8P GM-E GM-EP	
MODELOS		1970	GM-9	GM-9	
MODELOS		1974	GM-9P	GM-9P	
MODELOS	1978	GM-J GM-JP	GM-J GM-JP		
MODELOS	1976	GM-7	GM-11		



# AUTOMÓVIL - CAMIONETA

## CAR - PICK-UP TRUCKS

MARCA BRAND	MODELO MODEL			
GM (BUICK)			GM-7P	GM-11P
			GM-C	GM-7
			GM-CP	GM-7P
				GM-C
				GM-CP
				GM-D
				GM-DP
	MODELOS	1977	GM-8	GM-12
			GM-8P	GM-12P
			GM-E	GM-8
			GM-EP	GM-8P
				GM-E
				GM-EP
				GM-H
				GM-HP
	MODELOS	1979	GM-6	GM-10
			GM-6P	GM-10P
			GM-A	GM-6
			GM-AP	GM-6P
				GM-A
				GM-AP
				GM-B
				GM-BP
	MODELOS	1980	GM-7	GM-11
			GM-7P	GM-11P
		GM-C	GM-D	
		GM-CP	GM-DP	
MODELOS	1982	GM-9	GM-13	
		GM-9P	GM-13P	
		GM-J	GM-K	
		GM-JP	GM-KP	
MODELOS	1983	GM-6	GM-10	
		GM-6P	GM-10P	
		GM-A	GM-B	
		GM-AP	GM-BP	
MODELOS	1984	GM-6	GM-10	
MODELOS	1985	GM-6P	GM-10P	
		GM-7	GM-7	
		GM-7P	GM-7P	
		GM-A	GM-B	
		GM-AP	GM-BP	
		GM-C	GM-C	
		GM-CP	GM-CP	
REGAL	1988-1990	GM-19P		
REGAL	1991-	GM-20P		
RIVIERA	1995	GM-14	GM-14	
SKYLARK	1994	GM-14P	GM-14P	
		GM-25	GM-25	
		GM-25P	GM-25P	
RIVIERA 3.8V	1989-1990		GM-11	
			GM-11P	
			GM-D	
			GM-DP	
SKYLARK	1992-1993	GM-22	GM-22	



MARCA BRAND	MODELO MODEL			
GM (BUICK)			GM-22P	GM-22P
			GM-23	GM-23
			GM-23P	GM-23P
GM (CADILLAC)	ALLANTE	1987-1988	GM-16P	
	BROUGHAM	1996-1997		GM-12
	C.DE VILLE	1991-		GM-12P
	ELDORADO-TC	1991-		GM-H
	FLEETWOOD	1991-		GM-HP
	SEVILLE	1991-		
	ELDORADO-TC	1989-1990		GM-11
				GM-11P
				GM-D
				GM-DP
	MODELOS	1935-1966	BAS-11	BAS-11
	MODELOS	1966	GM-6	GM-6
	MODELOS	1967	GM-6P	GM-6P
	MODELOS	1971	GM-A	GM-A
	MODELOS	1975	GM-AP	GM-AP
	MODELOS	1986		
	MODELOS	1968	GM-7	GM-7
	MODELOS	1972	GM-7P	GM-7P
			GM-C	GM-C
			GM-CP	GM-CP
	MODELOS	1969	GM-8	GM-8
	MODELOS	1973	GM-8P	GM-8P
			GM-E	GM-E
			GM-EP	GM-EP
	MODELOS	1970	GM-9	GM-9
MODELOS	1974	GM-9P	GM-9P	
MODELOS	1978	GM-J	GM-J	
		GM-JP	GM-JP	
MODELOS	1976	GM-7	GM-11	
		GM-7P	GM-11P	
		GM-C	GM-7	
		GM-CP	GM-7P	
			GM-C	
			GM-CP	
			GM-D	
			GM-DP	
MODELOS	1977	GM-8	GM-12	
		GM-8P	GM-12P	
		GM-E	GM-8	
		GM-EP	GM-8P	
			GM-E	
			GM-EP	
			GM-H	
			GM-HP	
MODELOS	1979	GM-6	GM-10	
		GM-6P	GM-10P	
		GM-A	GM-6	
		GM-AP	GM-6P	
			GM-A	
			GM-AP	
			GM-B	



MARCA BRAND	MODELO MODEL				
GM (CADILLAC)				GM-BP	
	MODELOS	1980	GM-7 GM-7P GM-C GM-CP	GM-11 GM-11P GM-D GM-DP	
	MODELOS	1981	GM-8 GM-8P GM-E GM-EP	GM-12 GM-12P GM-H GM-HP	
	MODELOS	1982	GM-9 GM-9P GM-J GM-JP	GM-13 GM-13P GM-K GM-KP	
	MODELOS	1983	GM-6 GM-6P GM-A GM-AP	GM-10 GM-10P GM-B GM-BP	
	MODELOS	1984	GM-6	GM-10	
	MODELOS	1985	GM-6P GM-7 GM-7P GM-A GM-AP GM-C GM-CP	GM-10P GM-7 GM-7P GM-B GM-BP GM-C GM-CP	
	GM (CHEVROLET BRA.)	CHEVAIR	-	OP-WHP	OP-WHP
		CHEVROLET	1982-1987	OP-WYP	OP-WYP
		COMMODORE	-		
		MONZA	1982-1987		
		OMEGA	-		
		CHEVETTE	1987-1989	OP-R	OP-R
		CHEVROLET	1987-	OP-RP OP-T OP-TP	OP-RP OP-T OP-TP
		CHEVROLET	1989-1990	OP-D	OP-D
PANEMA		1989-	OP-DP OP-S OP-SP	OP-DP OP-S OP-SP	
CHEVROLET		1990-	SUZU-7	SUZU-7	
SPRINT 1.0		-	SUZU-7P	SUZU-7P	
DIPLOMATA		-	CHR-8 CHR-8P	CHR-8 CHR-8P	
MODELOS		1935-1966	BAS-11	BAS-11	
MODELOS		1966	GM-6	GM-6	
MODELOS		1967	GM-6P	GM-6P	
MODELOS		1971	GM-A	GM-A	
MODELOS		1975	GM-AP	GM-AP	
MODELOS		1986			
MODELOS		1968	GM-7	GM-7	
MODELOS		1972	GM-7P GM-C GM-CP	GM-7P GM-C GM-CP	
MODELOS	1969	GM-8	GM-8		
MODELOS	1973	GM-8P	GM-8P		



MARCA BRAND	MODELO MODEL			
GM (CHEVROLET BRA.)			GM-E GM-EP	GM-E GM-EP
	MODELOS	1970	GM-9	GM-9
	MODELOS	1974	GM-9P	GM-9P
	MODELOS	1978	GM-J GM-JP	GM-J GM-JP
	MODELOS	1976	GM-7 GM-7P GM-C GM-CP	GM-11 GM-11P GM-7 GM-7P GM-C GM-CP GM-C GM-CP GM-D GM-DP
	MODELOS	1977	GM-8 GM-8P GM-E GM-EP	GM-12 GM-12P GM-8 GM-8P GM-E GM-EP GM-H GM-HP
	MODELOS	1979	GM-6 GM-6P GM-A GM-AP	GM-10 GM-10P GM-6 GM-6P GM-A GM-AP GM-A GM-AP GM-B GM-BP
	MODELOS	1980	GM-7 GM-7P GM-C GM-CP	GM-11 GM-11P GM-D GM-DP
	MODELOS	1981	GM-8 GM-8P GM-E GM-EP	GM-12 GM-12P GM-H GM-HP
	MODELOS	1982	GM-9 GM-9P GM-J GM-JP	GM-13 GM-13P GM-K GM-KP
	MODELOS	1983	GM-6 GM-6P GM-A GM-AP	GM-10 GM-10P GM-B GM-BP
	MODELOS	1984	GM-6	GM-10
	MODELOS	1985	GM-6P GM-7 GM-7P GM-A GM-AP GM-C GM-CP	GM-10P GM-7 GM-7P GM-B GM-BP GM-C GM-CP



# AUTOMÓVIL - CAMIONETA

## CAR - PICK-UP TRUCKS

MARCA BRAND	MODELO MODEL			
GM (CHEVROLET)	ASTRO VAN	1996-1997	GM-14	GM-14
	CAVALIER	1996-1997	GM-14P	GM-14P
	LARGE BLAZER	1996-1997	GM-25	GM-25
	LARGE PICKUP	1996-1997	GM-25P	GM-25P
	MODELOS	1995		
	S-10 BLAZER	1996-1997		
	S-10 PICKUP	1996-1997		
	VENTURE	1997		
	BERETTA	1987-1990	GM-17P	GM-11
	CORSICA	1987-1990		GM-11P
				GM-D
				GM-DP
	BERETTA	1991-	GM-18P	GM-12
	CORSICA	1991-		GM-12P
				GM-H
				GM-HP
	CAMARO	1989-1990		GM-11
	CORVETTE	1989-1990		GM-11P
				GM-D
				GM-DP
	CAMARO	1991-		GM-12
	CAVALIER RS	1991-		GM-12P
	CORVETTE	1991-		GM-H
				GM-HP
	CAVALIER LS	1991-1992	GM-22	
			GM-22P	
	CAVALIER LS	1993-	GM-23	
			GM-23P	
	COLORADO	2004	TOYO-15	TOYO-15
			TOYO-15P	TOYO-15P
	IMPALA	2000-2005	GM-14	GM-14
			GM-14P	GM-14P
KODIAK 6	1997	GM-8	GM-12	
MODELOS	1981	GM-8P	GM-12P	
WHEELER	1997	GM-E	GM-H	
		GM-EP	GM-HP	
LUMINA	1988-1990	GM-19P	GM-11	
			GM-11P	
			GM-D	
			GM-DP	
LUMINA	1991-	GM-20P	GM-12	
			GM-12P	
			GM-H	
			GM-HP	
MODELOS	1935-1966	BAS-11	BAS-11	
MODELOS	1966	GM-6	GM-6	
MODELOS	1967	GM-6P	GM-6P	
MODELOS	1971	GM-A	GM-A	
MODELOS	1975	GM-AP	GM-AP	
MODELOS	1986			
MODELOS	1968	GM-7	GM-7	
MODELOS	1972	GM-7P	GM-7P	
		GM-C	GM-C	
		GM-CP	GM-CP	



MARCA BRAND	MODELO MODEL			
GM (CHEVROLET)	MODELOS	1969	GM-8	GM-8
	MODELOS	1973	GM-8P	GM-8P
			GM-E	GM-E
			GM-EP	GM-EP
	MODELOS	1970	GM-9	GM-9
	MODELOS	1974	GM-9P	GM-9P
	MODELOS	1978	GM-J	GM-J
			GM-JP	GM-JP
	MODELOS	1976	GM-7	GM-11
			GM-7P	GM-11P
			GM-C	GM-7
			GM-CP	GM-7P
				GM-C
				GM-CP
				GM-D
				GM-DP
	MODELOS	1977	GM-8	GM-12
			GM-8P	GM-12P
			GM-E	GM-8
			GM-EP	GM-8P
				GM-E
				GM-EP
				GM-H
				GM-HP
	MODELOS	1979	GM-6	GM-10
			GM-6P	GM-10P
			GM-A	GM-6
			GM-AP	GM-6P
				GM-A
				GM-AP
				GM-B
				GM-BP
MODELOS	1980	GM-7	GM-11	
		GM-7P	GM-11P	
		GM-C	GM-D	
		GM-CP	GM-DP	
MODELOS	1982	GM-9	GM-13	
		GM-9P	GM-13P	
		GM-J	GM-K	
		GM-JP	GM-KP	
MODELOS	1983	GM-6	GM-10	
		GM-6P	GM-10P	
		GM-A	GM-B	
		GM-AP	GM-BP	
MODELOS	1984	GM-6	GM-10	
MODELOS	1985	GM-6P	GM-10P	
		GM-7	GM-7	
		GM-7P	GM-7P	
		GM-A	GM-B	
		GM-AP	GM-BP	
		GM-C	GM-C	
		GM-CP	GM-CP	
SPARK	-	DAE-3P2	DAE-3P2	
SPECTRUM	1985-1989	GM-2	GM-2	



MARCA BRAND	MODELO MODEL			
GM (CHEVROLET)	SPRINT	1985-1988	GM-2P	GM-2P
			GM-1P	GM-1P
GM (GEO)	METRO	1989-	GM-5	GM-5
	STROM	1990-	GM-5P	GM-5P
	PRIZM	1993-1994	GM-24	GM-24
			GM-24P	GM-24P
	SPECTRUM	1985-	GM-2	GM-2
STROM	1989-1990	GM-2P	GM-2P	
GM (GMC)	MODELOS	1935-1966	BAS-1I	BAS-1I
	MODELOS	1966	GM-6	GM-6
	MODELOS	1967	GM-6P	GM-6P
	MODELOS	1971	GM-A	GM-A
	MODELOS	1975	GM-AP	GM-AP
	MODELOS	1986		
	MODELOS	1968	GM-7	GM-7
	MODELOS	1972	GM-7P	GM-7P
			GM-C	GM-C
			GM-CP	GM-CP
	MODELOS	1969	GM-8	GM-8
	MODELOS	1973	GM-8P	GM-8P
			GM-E	GM-E
			GM-EP	GM-EP
	MODELOS	1970	GM-9	GM-9
	MODELOS	1974	GM-9P	GM-9P
			GM-J	GM-J
	MODELOS	1978	GM-JP	GM-JP
			GM-11	GM-11
	MODELOS	1976	GM-7P	GM-11P
			GM-C	GM-7
			GM-CP	GM-7P
			GM-C	GM-C
			GM-CP	GM-CP
	MODELOS	1977	GM-D	GM-DP
			GM-8	GM-12
			GM-8P	GM-12P
GM-E			GM-8	
GM-EP			GM-8P	
MODELOS	1979	GM-E	GM-E	
		GM-EP	GM-EP	
		GM-H	GM-H	
		GM-HP	GM-HP	
		GM-10	GM-10	
MODELOS	1980	GM-6	GM-10	
		GM-6P	GM-10P	
		GM-A	GM-6	
		GM-AP	GM-6P	
		GM-A	GM-A	
MODELOS	1991-	GM-AP	GM-AP	
		GM-B	GM-B	
		GM-BP	GM-BP	
		GM-7	GM-11	
		SIERRA GLE	GM-7P	GM-11P
MODELOS	1980	GM-7	GM-11	
		GM-C	GM-D	



MARCA BRAND	MODELO MODEL			
GM (GMC)	MODELOS	1981	GM-CP	GM-DP
			GM-8	GM-12
			GM-8P	GM-12P
	MODELOS	1982	GM-E	GM-H
			GM-EP	GM-HP
			GM-9	GM-13
	MODELOS	1983	GM-9P	GM-13P
			GM-J	GM-K
			GM-JP	GM-KP
	MODELOS	1984	GM-6	GM-10
			GM-6P	GM-10P
			GM-A	GM-B
	MODELOS	1985	GM-AP	GM-BP
			GM-6	GM-10
			GM-6P	GM-10P
MODELOS	1986	GM-7	GM-7	
		GM-7P	GM-7P	
		GM-A	GM-B	
MODELOS	1987	GM-AP	GM-BP	
		GM-C	GM-C	
		GM-CP	GM-CP	
GM (OLDS MOBILE)	98 REGENCY	1991-		GM-12
	DELTA 88 RO.	1992-		GM-12P
	TORONADO	1991-		GM-H
	ACHIEVA	1992-1993	GM-22	
			GM-22P	
			GM-23	
	ACHIEVA	1994	GM-23P	
			GM-14	GM-14
			GM-14P	GM-14P
	AURORA	1995	GM-25	GM-25
	ALERO	00-04	GM-25P	GM-25P
			GM-14	GM-14
	INTRIGUE	00-03	GM-14P	GM-14P
	CUTLASS	1988-1990	GM-19P	
	SILHOUETTE	1988-1990		
CUTLASS SUP.	1991-	GM-20P		
MODELOS	1935-1966	BAS-1I	BAS-1I	
MODELOS	1966	GM-6	GM-6	
MODELOS	1967	GM-6P	GM-6P	
MODELOS	1971	GM-A	GM-A	
MODELOS	1975	GM-AP	GM-AP	
MODELOS	1986			
MODELOS	1968	GM-7	GM-7	
MODELOS	1972	GM-7P	GM-7P	
		GM-C	GM-C	
		GM-CP	GM-CP	
MODELOS	1969	GM-8	GM-8	
MODELOS	1973	GM-8P	GM-8P	
		GM-E	GM-E	
		GM-EP	GM-EP	
MODELOS	1970	GM-9	GM-9	



# AUTOMÓVIL - CAMIONETA

## CAR - PICK-UP TRUCKS

MARCA BRAND	MODELO MODEL			
GM (OLDS MOBILE)	MODELOS	1974	GM-9P	GM-9P
	MODELOS	1978	GM-J	GM-J
			GM-JP	GM-JP
	MODELOS	1976	GM-7	GM-11
			GM-7P	GM-11P
			GM-C	GM-7
			GM-CP	GM-7P
				GM-C
				GM-CP
				GM-D
				GM-DP
	MODELOS	1977	GM-8	GM-12
			GM-8P	GM-12P
			GM-E	GM-8
			GM-EP	GM-8P
				GM-E
				GM-EP
				GM-H
				GM-HP
	MODELOS	1979	GM-6	GM-10
			GM-6P	GM-10P
			GM-A	GM-6
			GM-AP	GM-6P
				GM-A
				GM-AP
				GM-B
				GM-BP
	MODELOS	1980	GM-7	GM-11
			GM-7P	GM-11P
			GM-C	GM-D
			GM-CP	GM-DP
	MODELOS	1981	GM-8	GM-12
			GM-8P	GM-12P
			GM-E	GM-H
			GM-EP	GM-HP
	MODELOS	1982	GM-9	GM-13
			GM-9P	GM-13P
			GM-J	GM-K
			GM-JP	GM-KP
	MODELOS	1983	GM-6	GM-10
			GM-6P	GM-10P
			GM-A	GM-B
		GM-AP	GM-BP	
MODELOS	1984	GM-6	GM-10	
MODELOS	1985	GM-6P	GM-10P	
		GM-7	GM-7	
		GM-7P	GM-7P	
		GM-A	GM-B	
		GM-AP	GM-BP	
		GM-C	GM-C	
		GM-CP	GM-CP	
TORONADO	1989-1990		GM-11	
			GM-11P	
			GM-D	
			GM-DP	

MARCA BRAND	MODELO MODEL			
GM (PONTIAC)	BONNEVILLE	1992-		GM-12
	FIREBIRD	1991-		GM-12P
	FORMULA	1991-		GM-H
	GTA	1991-		GM-HP
	TRANS AM	1991-		
	GRAND AM	00-05	GM-14	GM-14
	TORRENT	2000-2005	GM-14P	GM-14P
	GRAND AM	1992-1993	GM-22	
	SUNBIRD	1992-1993	GM-22P	
			GM-23	
			GM-23P	
	GRAND AM	1994	GM-14	GM-14
			GM-14P	GM-14P
			GM-25	GM-25
			GM-25P	GM-25P
	GRAND PRIX	1991-1994	GM-20P	
	LE MANS	1987-	OP-S	OP-S
			OP-SP	OP-SP
	MODELOS	1935-1966	BAS-11	BAS-11
	MODELOS	1966	GM-6	GM-6
	MODELOS	1967	GM-6P	GM-6P
	MODELOS	1971	GM-A	GM-A
	MODELOS	1975	GM-AP	GM-AP
	MODELOS	1986		
	MODELOS	1968	GM-7	GM-7
	MODELOS	1972	GM-7P	GM-7P
			GM-C	GM-C
			GM-CP	GM-CP
	MODELOS	1969	GM-8	GM-8
	MODELOS	1973	GM-8P	GM-8P
			GM-E	GM-E
			GM-EP	GM-EP
MODELOS	1970	GM-9	GM-9	
MODELOS	1974	GM-9P	GM-9P	
MODELOS	1978	GM-J	GM-J	
		GM-JP	GM-JP	
MODELOS	1976	GM-7	GM-11	
		GM-7P	GM-11P	
		GM-C	GM-7	
		GM-CP	GM-7P	
			GM-C	
			GM-CP	
			GM-D	
			GM-DP	
MODELOS	1977	GM-8	GM-12	
		GM-8P	GM-12P	
		GM-E	GM-8	
		GM-EP	GM-8P	
			GM-E	
			GM-EP	
			GM-H	
			GM-HP	
MODELOS	1979	GM-6	GM-10	



MARCA BRAND	MODELO MODEL			
GM (PONTIAC)			GM-6P	GM-10P
			GM-A	GM-6
			GM-AP	GM-6P
				GM-A
				GM-AP
				GM-B
				GM-BP
	MODELOS	1980	GM-7	GM-11
			GM-7P	GM-11P
			GM-C	GM-D
			GM-CP	GM-DP
	MODELOS	1981	GM-8	GM-12
			GM-8P	GM-12P
			GM-E	GM-H
			GM-EP	GM-HP
	MODELOS	1982	GM-9	GM-13
			GM-9P	GM-13P
			GM-J	GM-K
			GM-JP	GM-KP
	MODELOS	1983	GM-6	GM-10
		GM-6P	GM-10P	
		GM-A	GM-B	
		GM-AP	GM-BP	
MODELOS	1984	GM-6	GM-10	
MODELOS	1985	GM-6P	GM-10P	
		GM-7	GM-7	
		GM-7P	GM-7P	
		GM-A	GM-B	
		GM-AP	GM-BP	
		GM-C	GM-C	
		GM-CP	GM-CP	
SUNFIRE	00-05	GM-25	GM-25	
		GM-25P	GM-25P	
TRANS SPORT	1988-1990	GM-19P		
GM (SATURN)	SATURN	1990-1994	GM-21	GM-21
			GM-21P	GM-21P
HAMOMAG HENSCHEL	F 20	-	ME-VA	ME-VA
	F 35	-		
HOLDEN	APOLLO	1991-	TOYO-14	TOYO-14
	NOVA	1991-	TOYO-14P	TOYO-14P
	ASTRA	1986	DAT-12	DAT-12
	BARINA	1981-1990	MIT-11	MIT-11
	CAMIRA	1980-	MIT-11P	MIT-11P
	DROVER	1981-	TOYO-14	TOYO-14
	GEMINI	1980-1984	TOYO-14P	TOYO-14P
	JACKAROO	1980-		
	RODEO	1980-		
	SHUTTLE	1980-		
	BARINA	1991-1993	SUZU-10	SUZU-10
			SUZU-10P	SUZU-10P
	BARINA	1994	OP-S	OP-S
			OP-SP	OP-SP
	BELMOND	1971-1978	GM-6	GM-6



MARCA BRAND	MODELO MODEL			
HOLDEN	KINGSWOOD	1971-1978	GM-6P	GM-6P
	STATESMAN	1972-1978	GM-A	GM-A
	TORANA	1971-1972	GM-AP	GM-AP
	BELMOND	-1979	GM-42	GM-42
	CALAIS	1978-		
	COMMODORE	1978-		
	KINGSWOOD	1979-		
	STATESMAN	1978-		
	CALAIS	1993-	OP-WHP	OP-WHP
	COMMODORE	1993-		
	COMMODORE	1987-1993	OP-WHP	OP-WHP
			OP-WYP	OP-WYP
	FJ	-	HUD-1	HUD-1
	GEMINI	1985-	GM-2	GM-2
	SPECTRUM	1985-	GM-2P	GM-2P
	GEMINI STAT.	1981-	MIT-11	OP-AB
			MIT-11P	OP-ABP
			TOYO-14	OP-BA
			TOYO-14P	OP-BAP
				OP-J
			OP-JP	
MODELOS	1955-1970	BAS-11	BAS-11	
TORANA	-1971	BAS-11	UN-FS	
HONDA	ACCORD	1976-1980	HOND-1	HOND-1
	CIVIC	1973-1976	HOND-1P	HOND-1P
			HOND-2	HOND-2
			HOND-2P	HOND-2P
	ACCORD	1981-1982	HOND-10	HOND-10
	ACCORD	1984-1990	HOND-10P	HOND-10P
	CITY JAZZ	1981-1985		
	CIVIC	1984-1987		
	PRELUDE	1983-1988		
	PRELUDE	1989-1991		
	QUINTET	1981-1983		
	ACCORD	1982-1983	HOND-10	HOND-10
	CIVIC	1977-1981	HOND-10P	HOND-10P
			HOND-11	HOND-11
			HOND-11P	HOND-11P
	ACCORD	1990-1992	HOND-14	HOND-14
			HOND-14P	HOND-14P
			HOND-15	HOND-15
			HOND-15P	HOND-15P
			HOND-16D	HOND-16D
			HOND-16DP	HOND-16DP
	ACCORD 2 LS	1993-1995	NE-35	NE-35
	ACCORD 2 S	1993-1995	NE-35P2	NE-35P2
	CIVIC	1995		
	CONCERTO	1989-		
	ACCORD COUPE	1993-1995	HOND-14	HOND-14
	CIVIC	1988-1995	HOND-14P	HOND-14P
	ACCORD EX	1991-1995	HOND-16D	HOND-16D
			HOND-16DP	HOND-16DP
	CIVIC	1972-1973	NE-1	HOND-3D







# AUTOMÓVIL - CAMIONETA

## CAR - PICK-UP TRUCKS

MARCA BRAND	MODELO MODEL			
HONDA			NE-1P	
	CIVIC	1982-1983	HOND-12	HOND-12
	PRELUDE	1982	HOND-12P	HOND-12P
			HOND-13	HOND-13
			HOND-13P	HOND-13P
	CIVIC CRX	1989-1992	HOND-14	HOND-14
	CIVIC SHUTLE	1989-1992	HOND-14P	HOND-14P
			HOND-15	HOND-15
			HOND-15P	HOND-15P
	COUPE	1969-1975	NE-1	
	LIFE	1969-1975	NE-1P	
	N 360	1969-1975		
	TOURER	1969-1975		
	PRELUDE	1992-1997	HOND-14	HOND-14
			HOND-14P	HOND-14P
		HOND-16D	HOND-16D	
		HOND-16DP	HOND-16DP	
HUMMER	H2	2005-		
	H3	2005-		
HYUNDAI	ACCENT	1994-1996	HY-5	HY-5
	EXCEL	1994-1995	HY-5P	HY-5P
	ELANTRA	1991-1996	HY-4	HY-4
	LANTRA	1991-1996	HY-4P	HY-4P
	TIBURON	2001	HY-4P2	HY-4P2
			HY-4P3	HY-4P3
	EXCEL	1986-1989	HY-3D	HY-3D
			HY-3DP	HY-3DP
	EXCEL	1990-1991	HY-3D	HY-3D
	PONY	1991-	HY-3DP1	HY-3DP1
	S COUPE	1991-1996		
	SONATA	1991-1996		
	PONY	1974-1979	HY-1	HY-1
	PONY	1980-1984	TOYO-14	TOYO-14
			TOYO-14P	TOYO-14P
	PONY (CAN)	1985-1987	MIT-2I	MIT-2I
			MIT-2IP	MIT-2IP
	PONY (EU)	1985-1987	HY-2	HY-2
	STELLAR	1985-1987	HY-2P	HY-2P
			HY-7P	HY-7P
	SONATA	1989-1990	HY-3	HY-3
			HY-3P2	HY-3P2
SONATA (USA)	1993-1995	HY-6D	HY-6D	
SONICA	1993-1995	HY-6DP	HY-6DP	
STAREX	1998-	HY-9P2	HY-9P2	
VAN TRANSP.	1994-1997	HY-8	HY-8	
		HY-8P	HY-8P	
INFINITI (NIS-SAN)	G 20	1992-	DAT-10	DAT-10
	M 30	1992-	DAT-10P	DAT-10P
			DAT-7	DAT-7
			DAT-7P	DAT-7P
			DAT-7P1	DAT-7P1
	M 30	1990-1991	DAT-13	DAT-13
			DAT-13P	DAT-13P



MARCA BRAND	MODELO MODEL			
INFINITI (NIS-SAN)			DAT-14	DAT-14
			DAT-14P	DAT-14P
INNOCENTI	3 CILINDROS	1982		AF-10
	MINI 650	1985		AF-11
	MINI DIESEL	1984		AF-12
	MINI MILLE	1980		
	MINI TRE	1984		
	MINI TURBO	1983		
	500	1986-	FI-6I	FI-6I
	650	1986-	FI-6IP	FI-6IP
	990	1986-		
	SMALL 500	1986-		
	SMALL 990	1986-		
	A40	-	UN-FP	UN-FP
	ELBA	1992-	FI-11	FI-11
			FI-11P	FI-11P
	J 4	-	LF-BL	UN-FS
	J 5	-	UN-FS	
	JM 3	-		
	MINI 850	-		
	MINI 1000	1973		
	MINI 1001	1973		
	MINI COOPER	1973		
	KORAL 45	1990-1992	FI-6I	FI-3D
	KORAL 55	1990-1992	FI-6IP	FI-3DP
				FI-3DP5
	M.COOPER OR.	-	STR-2	STR-2
	M.MK II 850	-	UN-FS	UN-FS
	M.DE TOMASO	1976	AF-7I	AF-10
MINI 90	1974	AF-7IP	AF-11	
MINI 120	1974		AF-12	
M.METALLICA	-	LF-RO	UN-FS	
M.T.CLUBMAN	-	LF-ROP		
MINI MATIC	1970-	LF-BL	AF-10	
		UN-FS	AF-11	
			AF-12	
			UN-FS	
REGENT	-	LF-BL	UN-FT	
INTER. HARVESTER	T.TERRENO	-	GM-6	GM-10
			GM-6P	GM-10P
			GM-A	GM-B
			GM-AP	GM-BP
IRMSCHER	VARIOS	1940-1975	KEN-1	KEN-1
	4.0 I	-1981	GM-9	OP-R
			GM-9P	OP-RP
			GM-J	OP-T
			GM-JP	OP-TP
	4.0 I	1981-1986	OP-R	OP-R
			OP-RP	OP-RP
			OP-T	OP-T
			OP-TP	OP-TP
	4.0 I	1986-	OP-WHP	OP-WHP
C.40 E	-	OP-WYP	OP-WYP	



MARCA BRAND	MODELO MODEL			
ISUZU	AMIGO	1988-1991	GM-4	GM-4
	TF	1988-1991	GM-4P	GM-4P
			GM-4P1	GM-4P1
	AMIGO	1991-1994	GM-15D	GM-15D
	RODEO	1991-1994	GM-15DP	GM-15DP
	D-MAX	2002-2006	ISU-3D	ISU-3D
	I-290	2007	ISU-3DP	ISU-3DP
	I-370	2007		
	I MARK	1985-1991	GM-2	GM-2
			GM-2P	GM-2P
	IMPULSE	1985-1991	MIT-2I	MIT-2I
	PIAZZA	1985-1991	MIT-2IP	MIT-2IP
	TROOPER	1985-1991		
	IMPULSE	1992-	GM-5	GM-5
	STYLUS	1992-	GM-5P	GM-5P
	MODELOS	1981-1984	MIT-1I	MIT-1I
		MIT-1IP	MIT-1IP	
TROOPER	1982-1984	TOYO-14	TOYO-14	
		TOYO-14P	TOYO-14P	
TROOPER	1991-	GM-1P	GM-1P	
VEHY-CROSS	1998-2002	SUZU-10P	SUZU-10P	
JAGUAR	E	1970-1974	FO-D	UN-1FS
			FO-FR	UN-FS
			FO-FRP	
			WAS-2P	
	MAJESTIC	1989-1994	JAU-1P	JAU-1P
	SOVEREIGN	1989-1994		
	VANDEN PLAS	1989-1994		
	XJ 6	1989-1994		
	XJS	1988-		
	VANDEN PLAS	1988-1989		
	XJ 6-40	1988-1989		
	XJ 6	1971-1975	FO-D	IN-4
			FO-FR	UN-1FS
			FO-FRP	UN-FS
			WAS-2P	UN-FT
	XJ 6	1976-1978	FO-FR	FO-5
			FO-FRP	
			WAS-2P	
	XJ 6-12	1979-1987	FO-FR	CEM-JC
FO-FRP				
WAS-2P				
XJS	1975	FO-FR	UN-FT	
		FO-FRP		
		WAS-2P		
XJS	1976	FO-FR	LF-WR	
XJS	1978-1987	FO-FRP		
		WAS-2P		
XJS	1976-1977	LF-WR	FO-TC	
JDM	ABACA	2005-2012	SIX-3P	SIX-3P
	ALBIZIA	2003-2012		
	ALOES	2008-2012		
	ROSDY	2012		



MARCA BRAND	MODELO MODEL			
JEEP	BRIAR WOOD	1991-1992	CHR-9	CHR-9
	CHEROKEE	1991-1992	CHR-9P	CHR-9P
	COMANCHE	1991-1992		
	LAREDO	1991-1992		
	LTD	1991-1992		
	WRANGLER	1991-1992		
	CHEROKEE	1993-1998	CHR-10	CHR-10
	COMANCHE	1993-	CHR-10P	CHR-10P
	COUNTRY	1993-		
	G.CHEROKEE	1993-1998		
	G.WAGONEER	1993-		
	LAREDO	1993-		
	LTD	1993-		
	RENEGADE	1993-		
	SAHARA	1993-		
	SPURR	1993-		
	WAGONEER	1993-		
	WRANGLER	1993-		
	COMANCHE	1985-1990	GM-9	
	PIONNER	-1991	GM-9P	
	SCRAMBLER	1985-1990	GM-J	
	WAGONEERS	1985-1990	GM-JP	
	WRANGLER	1985-1990		
	COMMANDO D	-	FEM-3I	CL-4I
	RENEGADE	1979-1984	GM-9	YA-11D
			GM-9P	
			GM-J	
		GM-JP		
VARIOS	1940-1973	KEN-1	KEN-1	
JENSEN	INTERCEPT. 2	-	FO-FR	UN-FS
	INTERCEPT. 3	-	FO-FRP	
KENWORTH	VARIOS	1950-1987	KEN-1	KEN-1
	VARIOS	1960-1986	HUD-1	HUD-1
KIA	CARNIVAL	1999-	KI-3DP	KI-3DP
	CLARENCE	2001-		
	CLARUS	1998-2001		
	PRIDE	1999-		
	RIO	2001-		
	SHUMA	1998-2000		
	SORENTO	1998-		
	PRIDE 1.1 L	1992-1994	KI-1D	KI-1D
	PRIDE 1.3 LX	1992-1994	KI-1DP	KI-1DP
	SEPHIA (USA)	1994-1995		
	SEPHIA 1.6 I	1993-1994		
SPORTAGE	1995-1996			
SEPHIA (USA)	1994-	KI-1DP1	KI-1DP1	
SPORTAGE USA	1996-	KI-2D	KI-2D	
LA FORZA	FORZA 5.0 V8	1989-	GI0B-3P	
LADA VAZ	1200	1972-	NE-3	IMS-3
	1300	1972-	NE-3P	IMS-3P
	1500	1972-	NE-3P1	IMS-5
	1600	1972-	NE-3P2	IMS-5P
	2101	1972-		



# AUTOMÓVIL - CAMIONETA

## CAR - PICK-UP TRUCKS

MARCA BRAND	MODELO MODEL			
LADA VAZ	2102	1972-		
	2103	1972-		
	2104	1972-		
	2105	1972-		
	2106	1972-		
	2107	1972-		
	21011	1972-		
	21043	1972-		
	21061	1972-		
	NIVA	-		
	RIVA	-		
	3110	-	LA-3D	LA-2
			LA-3DP	LA-2P
			LA-4D	
			LA-4DP	
	4x4	-	LA-1D	LA-1D
	4x4 G.LARGE	-	LA-1DP	LA-1DP
	KAMA	1984-	LA-2	LA-2
	SAGONA	-	LA-2P	LA-2P
			LA-3D	LA-3D
		LA-3DP	LA-3DP	
CARLOTA	1991-	LA-1D	LA-1D	
SAMARA	1991-1992	LA-1DP	LA-1DP	
NIVA 1.6	1992-	NE-3	IMS-3	
		NE-3P	IMS-3P	
		NE-3P1		
		NE-3P2		
SAMARA	1992-	LA-3D	LA-2	
		LA-3DP	LA-2P	
LAMBORGHINI	COUNTACH	-	AF-7I	IMS-3
	DIABLO COU.	-	AF-7IP	IMS-3P
	DIABLO ROA.	-	AF-7IP1	IMS-5
	JALPA	-		IMS-5P
	URRACO	-		
	ESPADA	-	AF-7I	AF-5I
			AF-7IP	AF-6I
			AF-7IP1	
	MIURA	-	BH-1	AF-4D
			BH-1P	AF-4I
			AF-5D	
			AF-5I	
			AF-6D	
			AF-6I	
LANCIA	2000	-1972	GIOB-1D	GIOB-2I
	APPIA	-1972	GIOB-1DP	GIOB-2IP
	FLAVIA	-1972		
	FULVIA	-1972		
	2000	1972-	GIOB-1D	GIOB-2I
	FULVIA	1972-	GIOB-1DP	GIOB-2IP
			SIP-3	
	BETA	1972-1982	AF-7I	GIOB-3P
	DELTA	1979-1982	AF-7IP	
	GAMMA	1972-1982	FI-9I	



MARCA BRAND	MODELO MODEL			
LANCIA			FI-9IP	
	BETA	1975-1980	AF-7I	AF-10
	MONTECARLO	1975-1980	AF-7IP	AF-11
				AF-12
	DEDRA	1989-1995	FI-13	FI-13
	DEDRA S.W.	1994	FI-13P	FI-13P
	DELTA	1993-1995	FI-14P	FI-14P
	DELTA	1983	FI-3D	GIOB-3P
			FI-3DP	
			FI-3DP3	
			FI-6I	
			FI-6IP	
			FI-6IP3	
	DELTA	1984-1992	FI-11	GIOB-3P
	PRISMA	1984-1989	FI-11P	
	LANCIA Z	1994	SIX-3P1	SIX-3P1
	Z 2000	1994		
	MODELOS	2000		FI-16P1
	THEMA	1984-	FI-10	FI-10
			FI-10P	FI-10P
		FI-11	FI-11	
		FI-11P	FI-11P	
TREVI	1980-	FI-9I	GIOB-3P	
		FI-9IP		
LAND-RANGE ROVER	88	1982-1983	LF-RO	UN-FS
	88	1984	LF-ROP	
	109	1982-1983		
	109	1984		
	110	1984-1985		
	88	1985-1987	LF-RO	AB-6I
	109	1985-1987	LF-ROP	
	110	1986-1987		
	SANTANA	1985-1987		
	90	1985-1986	LF-RO	LF-RO
	110	1985-1986	LF-ROP	LF-ROP
	90	1987-1991	LF-RO	UN-FT
	110	1987-1991	LF-ROP	
	DEFENDER	1990-		
	90 2500	1988-1991	IMS-7	AB-6I
	90 3500	1988-1991	IMS-7P	
	110 2500	1985-1987		
	110 3500	1985-1987		
	SANTANA	1987-1991		
	DISCOVERY	1989-1993	NE-11	NE-11
		NE-11P1	NE-11P1	
		NE-11P2	NE-11P2	
DISCOVERY	1994-1997	NE-52P	NE-52P	
MODELOS	1970-1972	UN-FS	UN-FP	
MODELOS	1973-1981	UN-FS	UN-FS	
R.ROVER	-1983	UN-NH	UN-NH	
		UN-NHP	UN-NHP	
R.ROVER	1984-1988	NE-11	NE-11	
		NE-11P	NE-11P	



MARCA BRAND	MODELO MODEL			
LAND-RANGE ROVER			NE-11P	NE-11P
			NE-11P1	NE-11P1
			NE-11P2	NE-11P2
			NE-24	NE-24
			NE-24P	NE-24P
			NE-24P1	NE-24P1
	R.ROVER	1989-1997	NE-11	NE-11
			NE-11P	NE-11P
LEXUS (TOYOTA)	250 ES	1989-	TOYO-18P	TOYO-18P
	300 ES	1989-		
	400 LS	1989-		
	COUPE 300 SC	1991-		
	COUPE 400 SC	1991-		
LIGIER	IXO	2010	SIX-3P	SIX-3P
	JS	-		
	NOVA	1999-2004		
	OPTIMAX	2010		
	X-T00	2006-2012		
LOTUS	ECLAT	-	TOYO-K1	TOYO-K1
	EXCEL SE	-	TOYO-K1P	TOYO-K1P
	ELAN SE	1991	OP-D	OP-D
			OP-DP	OP-DP
	ESPRIT 2.2	-	LF-RO	UN-FT
	ESPRIT COUPE	1991-	LF-ROP	
	ESPRIT TURBO	-		
	MODELOS	-1976	FO-FR	UN-FS
			FO-FRP	UN-FT
			LF-RO	
LF-ROP				
MACK	VARIOS	1955-1969	KEN-1	KEN-1
	VARIOS	1970-1986	HUD-1	HUD-1
MARUTI	800	1991-1992	SUZU-7	SUZU-7
	800 LUXE	1991-1992	SUZU-7P	SUZU-7P
	800 S.LUXE	1991-1992		
MASERATI	BITURBO	1981-	LF-RO	AF-10
	GHIBLI	1986-	LF-ROP	AF-11
	KARIF	1986-		AF-12
	QUATTROPORTE	1976-1986		
	SHAMAL	1986-		
	SPYDER	1986-		
	BORA	1971-1976	AF-7I	RO-5D
			AF-7IP	
			AF-7IP1	
	GHIBLI 5000	-		IMS-3
				IMS-3P
	INDY 4900 A.	1969-	AF-7I	GIOB-2I
			AF-7IP	GIOB-2IP
			AF-7IP1	RO-5D
KHAM SIN	1972-	AF-7I	IMS-3	
		AF-7IP	IMS-3P	
		AF-7IP1	IMS-5	



MARCA BRAND	MODELO MODEL			
MASERATI				IMS-5P
	KYALAMI	1976-	FO-2	IMS-5
				IMS-5P
	MERAK	1972-1976	CT-3	RO-5D
			CT-3P	
MAZDA	121	1988-1990	MAZ-3D	MAZ-3D
	323	1983-1989	MAZ-6DP	MAZ-6DP
	323 S.W.	1986-1996		
	626	1987-1991		
	626 S.W.	1986-1992		
	727	1987-1991		
	929 S.W.	1982-		
	COSMO	1984-1986		
	MX6	1986-1989		
	RX7	1987-1991		
	121	1991-1992	MAZ-5D	MAZ-5D
			MAZ-5DP	MAZ-5DP
			MAZ-7D	MAZ-7D
			MAZ-7DP	MAZ-7DP
	121	1993-1994	MAZ-13D	MAZ-13D
			MAZ-13DP	MAZ-13DP
	323	1992-1994	MAZ-13DP1	MAZ-13DP1
			MAZ-7D	MAZ-7D
	MX3	1992-1995	MAZ-7D	MAZ-7D
			MAZ-7DP	MAZ-7DP
	RX7	1992-	MAZ-7DP	MAZ-7DP
	XEDOS	1992-1996		
121	1995-	FO-6P	FO-6P	
323	1977-1982	MAZ-2D	MAZ-2D	
		MAZ-2DP	MAZ-2DP	
323 S.W.	1977-1986			
626	1978-1982			
929	1980-1982			
929 S.W.	1980-1982			
323	1982-1983	MAZ-3D	MAZ-3D	
		MAZ-3DP	MAZ-3DP	
		MAZ-3I	MAZ-3I	
		MAZ-3IP	MAZ-3IP	
323	1989-1992	MAZ-3D	MAZ-3D	
		MAZ-7D	MAZ-7D	
		MAZ-7DP	MAZ-7DP	
323	1995		MAZ-7DP1	
MX3	1995			
MX5	1995			
323 B.F.	1982	NE-23	MAZ-2D	
		NE-26	MAZ-2DP	
			MAZ-2I	
			MAZ-2IP	
323 S.P.	1990	MAZ-7D	MAZ-7D	
MPV	1989-	MAZ-7DP	MAZ-7DP	
MX5 (EU)	1990-1992			
MX6	1990-1992			
616 CAP.	-1970	DAT-3I	MAZ-2D	
616 SNA	-1970		MAZ-2DP	
RX2 CAPPE.	1970-1971			
616 CAPE.	1971-1973	DAT-11D	MAZ-2D	



# AUTOMÓVIL - CAMIONETA

## CAR - PICK-UP TRUCKS

MARCA BRAND	MODELO MODEL			
MAZDA	618	1971-1973	DAT-11DP	MAZ-2DP
	RX2 CAPPE.	1974-1977	WAS-2P	
	RX3	1974-1977		
	626	1982-1987	MAZ-3D	MAZ-3D
	929	1982-1986	MAZ-3DP	MAZ-3DP
			MAZ-3I	MAZ-3I
			MAZ-6DP	MAZ-6DP
			MAZ-6P	MAZ-6P
	626	1991	MAZ-7D	MAZ-7D
	MX3	1991-1992	MAZ-7DP	MAZ-7DP
			MAZ-7DP1	MAZ-7DP1
	626	1991-1995	MAZ-13D	MAZ-13D
	MX6	1992-1995	MAZ-13DP	MAZ-13DP
			MAZ-13DP1	MAZ-13DP1
	626	1995-1997		MAZ-13D
	MX6	1995-1997		MAZ-13DP
	XEDOS 6	1995-1997		MAZ-13DP1
	626 GL	1981	CHR-3	MAZ-2D
			NE-22P2	MAZ-2DP
	626 S.W.	1993-1996	MAZ-5D	MAZ-5D
	RX7	1991	MAZ-5DP	MAZ-5DP
	808	1971-1977	DAT-11D	MAZ-2D
	818	1971-1977	DAT-11DP	MAZ-2DP
	929	1973-1980	WAS-2P	MAZ-2I
				MAZ-2IP
	818 1.3	-1971	DAT-3I	MAZ-1I
	818 1.5	-1971		
	1800	1971-1972		
	929 GLX	1987-	MAZ-3D	MAZ-3D
	RX7	1983-1986	MAZ-3DP	MAZ-3DP
			MAZ-6DP	MAZ-6DP
	1200	1970-1972	DAT-11D	MAZ-1I
	1800	1970-1971	DAT-11DP	
		WAS-2P		
1600	1972-	DAT-3I	MAZ-1D	
R 100	1970-1971			
ARTIS	-	MAZ-21DP1	MAZ-21DP1	
B 1800	1970-1971	MAZ-1I	MAZ-1I	
COSMO	1975-1979	MAZ-16	MAZ-16	
COSMO	1980	MAZ-3D	MAZ-3D	
GLC 323	1983-1989	MAZ-3DP	MAZ-3DP	
COSMO	1982-1983	MAZ-3D	MAZ-3D	
		MAZ-3DP	MAZ-3DP	
		MAZ-3I	MAZ-3I	
		MAZ-6P	MAZ-6P	
E 1600	1986	MAZ-2D	MAZ-2D	
		MAZ-2DP	MAZ-2DP	
		MAZ-2I	MAZ-2I	
		MAZ-2IP	MAZ-2IP	
		MAZ-3D	MAZ-3D	
		MAZ-3DP	MAZ-3DP	
		MAZ-3I	MAZ-3I	
		MAZ-3IP	MAZ-3IP	



MARCA BRAND	MODELO MODEL			
MAZDA	EUNOS 800	1993-	TOYO-18P	TOYO-18P
	XEDOS 9	1993-1996		
	MIATA	1989-1992	MAZ-3D	MAZ-3D
	MX5	1989-1992	MAZ-7D	MAZ-7D
			MAZ-7DP	MAZ-7DP
			MAZ-7DP1	MAZ-7DP1
	MODELOS	1970-1974	MAZ-14D	MAZ-14D
	MODELOS	1975-1984	MAZ-1D	MAZ-2D
			MAZ-1I	MAZ-2DP
				MAZ-2I
				MAZ-2IP
	NAVAJO	1991-	MAZ-8D	MAZ-8D
			MAZ-8DP	MAZ-8DP
	R 100	1972-	DAT-11D	MAZ-1D
	R 1200	1972-	DAT-11DP	
			WAS-2P	
	RX2	1972-1973	DAT-11D	MAZ-2I
			DAT-11DP	MAZ-2IP
			WAS-2P	
	RX4 LUCE	1972-1978	MAZ-2D	MAZ-2D
RX5 COSMO	1972-1978	MAZ-2DP	MAZ-2DP	
RX7 COUPE	1972-1978	MAZ-2I	MAZ-2I	
		MAZ-2IP	MAZ-2IP	
MERCEDES	180C	1993-	ME-7P	ME-7P
	200C	1993-	ME-8P	ME-8P
	220C	1993-		
	280C	1993-		
	300C	1993-		
	190	1984-1986	ME-10P	ME-10P
	200	1984-	ME-2P	ME-2P
	230	1984-	ME-3P	ME-3P
	250	1984-	ME-4P	ME-4P
	260	1984-	ME-5P	ME-5P
	280	1979-	ME-6P	ME-6P
	300	1980-		
	360	1984-		
	380	1979-		
	420	1984-		
	450	1979-		
	500	1979-		
	560	1984-		
	1000	1984-		
	190	1986-	ME-4P	ME-4P
			ME-5P	ME-5P
	190 ALARM	1986-1992	ME-10P	ME-10P
			ME-11P	ME-11P
			ME-12P	ME-12P
200	1973-1974	ME-HD	ME-HD	
220	1973-1974	ME-HDP	ME-HDP	
230	1973-1974	ME-HF	ME-HF	
240D	1973-1976	ME-HFP	ME-HFP	
250	1973-1977	ME-HM	ME-HM	
280	1973-1974	ME-HMP	ME-HMP	

MARCA BRAND	MODELO MODEL			
MERCEDES	350	1973-	ME-HZ	ME-HZ
	380	1973-1977	ME-HZP	ME-HZP
	450	1973-1979		
	200	1974-1975	ME-HD	ME-HD
	220	1974-	ME-HDP	ME-HDP
	230	1974-1977	ME-HZ	ME-HZ
	240	1974-1977	ME-HZP	ME-HZP
	280	1974-1979		
	200	1975-1976	ME-HF	ME-HF
			ME-HFP	ME-HFP
			ME-HM	ME-HM
			ME-HMP	ME-HMP
	200	1976-1977	ME-HU	ME-HU
	240D	1976-	ME-HUP	ME-HUP
	300D	1976-	ME-NU	ME-NU
			ME-NUP	ME-NUP
	200	1977-1984	ME-HU	ME-HU
	230	1977-1984	ME-HUP	ME-HUP
	240	1977-	ME-HY	ME-HY
	250	1977-1984	ME-HYP	ME-HYP
	300	1977-1980	ME-NU	ME-NU
	380	1977-1979	ME-NUP	ME-NUP
			ME-NY	ME-NY
			ME-NYP	ME-NYP
	206D	-	ME-VA	ME-VA
	306D	-		
	207D	-1992	ME-HM	ME-HM
	207F	-1992	ME-HMP	ME-HMP
	207K	-1992		
	208D	-1992		
	209D	-1992		
	307D	-1992		
	308D	1992-		
	L 508	-1991		
	L 608	-1991		
	LN 914	-1991		
	MB 308DT	-1991		
	MB 408DT	-1991		
	U 900	-1991		
	U 1700	-1991		
220	-1972	ME-HF	ME-HF	
230	-1972	ME-HFP	ME-HFP	
250	-1972	ME-HZ	ME-HZ	
280	-1972	ME-HZP	ME-HZP	
300	-1972			
350	-1972			
7200	-1972			
230	-	ME-HF	ME-HF	
240	-	ME-HFP	ME-HFP	
280	-	ME-HM	ME-HM	
300	-	ME-HMP	ME-HMP	
TODO T. 4WD	-	ME-HZ	ME-HZ	
		ME-HZP	ME-HZP	

MARCA BRAND	MODELO MODEL			
MERCEDES	400	-1994	ME-2P	ME-2P
	600	-1994	ME-3P	ME-3P
	711	1996-	ME-HMP	ME-HMP
	814	1996-		
	817	1996-		
	917	1996-		
	1117	1996-		
	1300	1996-		
	1500	1996-		
	SPRINTER	1996-		
	VARIO	1996-		
	MB 100D	-1994	ME-1	ME-1
			ME-1P	ME-1P
	MODELOS	-1970	NE-61D	
			NE-62	
	VITO	1996-	ME-HMP	ME-HMP
			ME-HZ	ME-HZ
			ME-HZP	ME-HZP
	VITO	1997-	ME-HMLP	ME-HMLP
	MG	MG	1970-1974	UN-NH
MGB		1970-1974	UN-NHP	
MGB GT		1970-1975		
MG		1975-1977	NE-1	UN-FS
MGB		1975-1978	NE-1P	
MG		1978-	NE-10	UN-FS
			NE-10P	UN-FS
MGF		1997	NE-10P	NE-10P
MODELOS		-1970	UN-FP	UN-FP
			UN-FS	UN-FS
MICROCAR	FAMILY	2007-2009	SIX-3P	SIX-3P
	M.GO	2009		
	NEWSTREET	2008		
	PRATIC	2008		
	VIRGO	2008		
MITSUBISHI	3000 GT/R/SL	-	MIT-12	MIT-12
	BRAVO	-	MIT-7	MIT-7
	CHARIOT	1987-	MIT-7P	MIT-7P
	COLT	1987-1993		
	DIAMANTE	1992-		
	ECLIPSE	1987-		
	ETERNA	1989-		
	EXPO	-		
	GALANT	1987-1996		
	L 200	1987-		
	L 300	1987-		
	LANCER	1987-1996		
	MINICAB	1987-		
	MIRAGE	1987-1993		
	MONTERO	1992-1996		
MX SUPER A.R	-			
NIMBUS	1987-			
PAJERO	1992-1996			
S.RUNNER	1992-1998			



# AUTOMÓVIL - CAMIONETA



## CAR - PICK-UP TRUCKS

MARCA BRAND	MODELO MODEL			
MITSUBISHI	SHOGUN	-		
	SPACE GEAR	1995		
	SPACE WAGON	1985-		
	CANTER	1997	MIT-15P	MIT-15P
	CELESTE	1972-1980	MIT-11	MIT-11
	COLT	1972-1980	MIT-11P	MIT-11P
	GALANT	1972-1980		
	LAMBDA	1972-1980		
	LANCER	1972-1980		
	MINICA	1972-1980		
	STARION	1972-1980		
	COLT	1981-1984	MIT-21	MIT-21
	CORDIA	1981-1984	MIT-21P	MIT-21P
	DEBONAIR	1981-1984		
	ETERNA	1981-1983		
	GALANT	1981-1983		
	L 300	-1983		
	L 300 VAN	1981-1984		
	LANCER	1981-1983		
	MINICA	1981-1983		
	MONTERO	1981-1992		
	PAJERO	1981-1992		
	SAPPORO	1981-1984		
	SHOGUN	1981-1984		
	SIGMA	1981-1984		
	SPACE WAGON	1981-1983		
	STARION	1981-1983		
	VISTA	-1993		
	COLT	1984-1987	MIT-3	MIT-3
	DEBONAIR	1983-1985	MIT-3P	MIT-3P
	ETERNA	1983-1989	MIT-4	MIT-4
	GALANT	1983-1987	MIT-4P	MIT-4P
	L 300	1983-1987		
	LANCER	1983-1987		
	MINICA	1983-1987		
	ORCHID	1983-1985		
	SPACE WAGON	1983-1985		
	STARION	1983-1985		
	TREDIA	1983-1985		
	COLT	1993-1996	MIT-13D	MIT-13D
	MIRAGE	1993-	MIT-14D	MIT-14D
			MIT-8D	MIT-8D
			MIT-8DP	MIT-8DP
	INTERCOOLER	1992-	CHR-17	CHR-17
			MIT-12	MIT-12
			MIT-7	MIT-7
			MIT-7P	MIT-7P
	L 400	1997-	MIT-7P	MIT-7P
	MODELOS	1985-1986	MIT-5	MIT-5
			MIT-5P	MIT-5P
			MIT-6	MIT-6
			MIT-6P	MIT-6P
PRECIS	1986-	HY-3D	HY-3D	

MARCA BRAND	MODELO MODEL				
MITSUBISHI			HY-3DP1	HY-3DP1	
	SUMMIT	1993-	MIT-8D	MIT-8D	
	VISTA	1993-	MIT-8DP	MIT-8DP	
	MOSKVITCH	408	-	NE-3	MOS-1
		412	-	NE-3P	VOL-3
		426	-	NE-3P1	
		427	-	NE-3P2	
		2135	-		
		2136	-		
		2137	-		
		2138	-		
		2140	-		
		2141 ALEKO	-	LA-3D	LA-3D
			LA-3DP	LA-3DP	
	NISSAN	200 SX	-1983	DAT-12	DAT-12
240 Z		-1983	DAT-6	DAT-6	
280 Z		-1983	DAT-6P	DAT-6P	
300 L		-1983	DAT-7	DAT-7	
300 ZX		-1983	DAT-7P	DAT-7P	
AUSTER		-1983			
AXXESS		-1983			
BLUEBIRD		-1983			
CEDRIC		-1983			
CHERRY		-1983			
EXA		-1983			
FAIRLADY		-1983			
GAZELLE		-1983			
GLORIA		-1983			
LANGLEY		-1983			
LAUREL		-1983			
LEOPARD		-1983			
LIBERTA VIL.		-1983			
MARCH		-1983			
MAXIMA		-1983			
MICRA		-1983			
PAO		-1983			
PINTARA		-1983			
PRAIRE		-1983			
PRESIDENT		-1983			
PULSAR		-1983			
SENTRA		-1983			
SILVIA		-1983			
SKYLINE		-1983			
STANZA		-1983			
SUNNY		1983-1989			
TULIP		-1983			
VANETTE		-1983			
VIOLET		-1983			
240 Z	1969-1973	DAT-5D	DAT-1D		
280 Z	1969-1973		DAT-1DP		
BLUEBIRD	1977-1979				
CHERRY	1977-1979				
SENTRA	1977-1979				





MARCA BRAND	MODELO MODEL			
NISSAN	SKYLINE	1977-1979		
	SUNNY	1977-1979		
	VIOLET	1977-1979		
	240 Z	1974-1983	DAT-5D	DAT-2D
	260 Z	1974-1983		DAT-2DP
	280 Z	1974-1983		DAT-2I
	280 ZX ST.W	1974-1983		DAT-2IP
	1200 DE LUXE	-1971		DAT-4I
	1200 VAN	-1971		
	1200 DE LUXE	1971-1972	DAT-8	DAT-7
			DAT-8P	DAT-7P
	BLUEBIRD	1970-1976	DAT-5D	DAT-8
	CHERRY	1970-1976		DAT-8I
	SENTRA	1970-1976		DAT-8IP
	SKYLINE	1970-1976		DAT-8IP1
	SUNNY	1970-1976		DAT-8P
	VIOLET	1970-1976		
	BLUEBIRD	1976-1979	DAT-1D	DAT-1D
			DAT-1DP	DAT-1DP
			DAT-1I	DAT-1I
			DAT-1IP	DAT-1IP
	BLUEBIRD	1980-1982	DAT-9D	DAT-9D
			DAT-9DP	DAT-9DP
			DAT-9I	DAT-9I
			DAT-9IP	DAT-9IP
	CEDRIC	1995-1997	DAT-15	DAT-15
	GLORIA	1995-1997	DAT-15P	DAT-15P
	PATHFINDER	1996-1997	DAT-16	DAT-16
	CHERRY	1980-1982	NE-11	DAT-1D
			NE-11P	DAT-1DP
				DAT-1I
				DAT-1IP
	FLORIDA	1989-1991	DAT-6	DAT-6
	PATROL 4x4	1986-	DAT-6P	DAT-6P
	SUNNY	1989-1991		
	TERRANO	1989-1995		
	TRADE	1989-		
	MAXIMA	1980-1982	DAT-2D	DAT-2D
			DAT-2DP	DAT-2DP
			DAT-2I	DAT-2I
		DAT-2IP	DAT-2IP	
MAXIMA	1991-1995	DAT-10	DAT-7	
		DAT-10P		
MICRA	1993-1995	DAT-10	DAT-10	
PRIMERA	1991-1995	DAT-10P	DAT-10P	
TERRANO	1995			
TERRANO II	1993-1995			
PATHFINDER	1991-	DAT-12	DAT-12	
SENTRA	1991-			
PATROL 4 WD	-1985	DAT-8	DAT-8	
		DAT-8P	DAT-8P	
QUEST	1993-	FO-8D	FO-8D	
		FO-8DP	FO-8DP	



MARCA BRAND	MODELO MODEL				
NISSAN			FO-8DP1	FO-8DP1	
	QUEST	1993-1994	DAT-19	DAT-19	
			DAT-19P	DAT-19P	
	QUEST	1996	DAT-20	DAT-20	
			DAT-20P	DAT-20P	
	SERENA	1993-1996	DAT-6	DAT-6	
			DAT-6P1	DAT-6P1	
	URVAN	-1994	DAT-12	DAT-12	
				DAT-1D	
				DAT-1DP	
	VANETTE	1983-1996	DAT-12	DAT-12	
			DAT-6	DAT-6	
			DAT-6P	DAT-6P	
	NISSAN (AUSTRALIA)	PINTARA	-1983	DAT-12	DAT-12
		PULSAR	-1983	DAT-6	DAT-6
			DAT-6P	DAT-6P	
			DAT-7	DAT-7	
			DAT-7P	DAT-7P	
NISSAN (USA)	810	1980-1982	DAT-2D	DAT-2D	
			DAT-2DP	DAT-2DP	
			DAT-2I	DAT-2I	
			DAT-2IP	DAT-2IP	
	810	1983-	DAT-12	DAT-12	
			DAT-6	DAT-6	
			DAT-6P	DAT-6P	
			DAT-7	DAT-7	
			DAT-7P	DAT-7P	
NSU	RO 80	-			
OM IVECO	40	-	AF-9D	AF-5D	
			AF-9DP	AF-5I	
			AF-9I	AF-6D	
			AF-9IP	AF-6I	
	50.10	1979-1981	LF-RO	IMS-3	
	60.10	1979-1981	LF-ROP	IMS-3P	
	65.10	1979		IMS-5	
	70.10	1979		IMS-5P	
	50.10	1981	SIP-1	IMS-3	
	60.10	1981		IMS-3P	
	70.10	1981		IMS-5	
	75.10	1981		IMS-5P	
	79.10	1981			
	79.13	1981			
	75	-	AF-9D	FI-5D	
			AF-9DP	FI-5I	
			AF-9I	IMS-3	
			AF-9IP	IMS-3P	
			FEM-1D	IMS-5	
			FEM-1I	IMS-5P	
	100.13	-	AF-8D	IMS-3	
	160	-	AF-8DP	IMS-3P	
	160.26	-	AF-8I	IMS-5	
			AF-8IP	IMS-5P	
			AF-9D		









# AUTOMÓVIL - CAMIONETA

## CAR - PICK-UP TRUCKS

MARCA BRAND	MODELO MODEL			
OM IVECO			AF-9DP	
			AF-9I	
			AF-9IP	
	100.13	-1978	AF-9D	IMS-3
	110.110P	-1978	AF-9DP	IMS-3P
	110.13	-1978	AF-9I	IMS-5
	130	-1978	AF-9IP	IMS-5P
			FEM-1D	
			FEM-1I	
	130	-	FEM-1D	IMS-3
	130 R	-	FEM-1I	IMS-3P
	130 R/H	-		IMS-5
	130 T/H	-		IMS-5P
	150 R20	-	AF-9D	FI-5D
	150 T20	-	AF-9DP	FI-5I
	150.20	-	AF-9I	IMS-3
	159.20	-	AF-9IP	IMS-3P
	190 T30	-		IMS-5
	190.30	-		IMS-5P
	190.35	-	AF-7I	IMS-3
	190.38	-	AF-7IP	IMS-3P
	190.38 TUR.	-	AF-9D	IMS-5
			AF-9DP	IMS-5P
			AF-9I	
			AF-9IP	
	330.26	-	VO-VB	IMS-3
	330.35	-	VO-VBP	IMS-3P
				IMS-5
				IMS-5P
	DAINO 145	-	BH-4	AF-5D
	LUPETTO	-		AF-5I
				AF-6D
				AF-6I
	GRINTA	-	AF-7I	IMS-3
			AF-7IP	IMS-3P
			FI-9I	IMS-5
			FI-9IP	IMS-5P
			LF-RO	
			LF-ROP	
	LEONCINO	-	BH-4	AF-4D
			AF-4I	
ORSETTO	-	FEM-1D	AF-5D	
		FEM-1I	AF-5I	
			AF-6D	
			AF-6I	
OPEL-VAUXHALL	ADMIRAL	-1973	OP-6	OP-6
	KADETT	-1973	OP-7	OP-7
	OLIMPYA	-1973	OP-8	OP-8
	REKORD	-1973	OP-9	OP-9
			OP-BB	OP-BB
			OP-EE	OP-EE
			OP-FF	OP-FF
	ASCONA	-1974	OP-HA	OP-HA



MARCA BRAND	MODELO MODEL			
OPEL-VAUXHALL	MANTA	-1974	OP-HB	OP-HB
			OP-HG	OP-HG
			OP-HH	OP-HH
	ASCONA	1975-1981	OP-AB	OP-AB
	KADETT	1973-1983	OP-ABP	OP-ABP
	MANTA	1975-1981	OP-BA	OP-BA
			OP-BAP	OP-BAP
			OP-J	OP-J
			OP-JP	OP-JP
	ASCONA	1982-	OP-WHP	OP-WHP
	CALIBRA	1987-1995	OP-WYP	OP-WYP
	CARAVAN	1992-		
	COMMODORE	1982-		
	MANTA	1982-		
	MONZA	1984-		
	OMEGA	1987-1995		
	REKORD	1984-		
	VECTRA	1987-1995		
	ASTRA	1991-1995	OP-D	OP-D
	CORSA	1984-1995	OP-DP	OP-DP
	CORSA VAN	1984-1995	OP-S	OP-S
	KADETT	1984-	OP-SP	OP-SP
	ASTRA VAN	1991-1995	OP-D	OP-D
	COMBO	-	OP-DP	OP-DP
	FRONTERA	1992-1996	GM-4	GM-4
	MONTERREY	1992-	GM-4P	GM-4P
			GM-4P1	GM-4P1
	MANTA 1.8	1975-1979	OP-J	OP-J
			OP-JP	OP-JP
	MIDI	1992-	MIT-3	MIT-3
			MIT-3P	MIT-3P
	MONZA	1974-1981	OP-R	OP-R
	REKORD	1974-1984	OP-RP	OP-RP
	SENATOR	1984-	OP-T	OP-T
			OP-TP	OP-TP
	MONZA	1981-1984	GM-9	OP-R
	SENATOR	1981-1984	GM-9P	OP-RP
			GM-J	OP-T
			GM-JP	OP-TP
	TIGRA	1994	OP-SP1	OP-SP1
PEUGEOT	104	1972	LMP-1	VA-6
			LMP-1P	VA-6P
			NE-4	
			NE-4P	
			NE-4P1	
	104	1978	NE-4	NE-4
	504	1975-	NE-4P	NE-4P
	604	1975-1980	NE-4P1	NE-4P1
	104	1979	LMP-2	LAS-V
			LMP-2P	VA-6
		NE-4	VA-6P	
		NE-4P		



MARCA BRAND	MODELO MODEL			
PEUGEOT			NE-4P1	
	104	1980	CHR-3	CHR-3
	104	1982-	CHR-3P	CHR-3P
	305	1978-1980	NE-22P1	NE-22P1
	305	1983-1987		
	505	1979-1980		
	505 BREAK	1981-1983		
	604	1981-		
	104	1981	LMP-4	LMP-4
	505 BERLINA	1981-1983	LMP-4P	LMP-4P
			LMP-5	LMP-5
			LMP-5P	LMP-5P
	106	1991-1997	NE-36	NE-36
			NE-36P1	NE-36P1
	106 SERVICE	-1993	NE-19	NE-19
	205 SERVICE	-1993	NE-20P1	NE-20P1
	309 SERVICE	1985-		
	405 AFFAIRE	1987-1991		
	204	1965-	NE-37	VA-6
	304	1969-1978	NE-37P	VA-6P
	404	1965-	NE-4	
	504 BERLINA	1968-1974	NE-4P	
			NE-4P1	
	205	1984	NE-20	NE-20
			NE-20P	NE-20P
			NE-29	NE-29
			NE-29P	NE-29P
	205	1985-1991	NE-20	NE-20
	505	1985-	NE-20P1	NE-20P1
			NE-29	NE-29
	205	1991-1993	NE-20	NE-20
	405	1991-1993	NE-20P1	NE-20P1
			NE-29	NE-29
			NE-36	NE-36
			NE-36P1	NE-36P1
	205	1993-	NE-20P2	NE-20P2
	405	1993-	NE-36	NE-36
			NE-36P1	NE-36P1
	305	1981-1982	SIX-1	SIX-1
			SIX-1P1	SIX-1P1
	305 SERVICE	1983-	CHR-3	CHR-3
			NE-22P1	NE-22P1
	306	1993-1997	NE-20P2	NE-20P2
			NE-36	NE-36
309	1985-	NE-20	NE-20	
405	1987-1991	NE-20P1	NE-20P1	
		NE-29	NE-29	
		NE-29P	NE-29P	
406	1995-1997	NE-51P2	NE-51P2	
504 BREAK	1968-1974	NE-4	RO-11D	
		NE-4P		
		NE-4P1		



MARCA BRAND	MODELO MODEL			
PEUGEOT	504 PICK UP	1975-	NE-4	NE-4
			NE-4P1	NE-4P1
	505	1984	NE-20	NE-20
			NE-20P	NE-20P
	505 SERVICE	1979-	CHR-3	LAS-R
			NE-22P1	LAS-V
	605	1990-	NE-34P	NE-34P
	806	1994	SIX-3P1	SIX-3P1
	EXPERT	1995-1996		
	J-5	-	FI-12	FI-12
			FI-12P3	FI-12P3
			FI-3D	FI-3D
			FI-3DP3	FI-3DP3
			FI-6I	FI-6I
			FI-6IP3	FI-6IP3
	J-7	-	NE-4	
			NE-4P1	
	J-9	-	NE-4	RO-4D
			NE-4P1	RO-4I
				RO-5D
				RO-5I
	PARTNER	1997	SIX-3P1	SIX-3P1
RANCH	1997	SIX-3P2	SIX-3P2	
PEUGEOT (AR-GEN.)	404	-	NE-3	NE-43
			NE-3P	
			NE-3P2	
405	-	NE-20	NE-20	
		NE-20P1	NE-20P1	
504	-	NE-3	NE-3	
		NE-3P	NE-3P	
		NE-3P2	NE-3P2	
		NE-4	NE-4	
		NE-4P	NE-4P	
504 PICK UP	-	NE-4	NE-4	
		NE-4P	NE-4P	
505	-	NE-20	NE-20	
		NE-20P1	NE-20P1	
		NE-42	NE-42	
		NE-42P	NE-42P	
		NE-42P1	NE-42P1	
PIAGGIO	PORTER	1993-1994	DAI-1P	DAI-1P
PORSCHE	911 CARRERA	1970-	PO-HC	PO-HC
	912	1970-	PO-HCP	PO-HCP
	914	1970-	PO-NC	PO-NC
			PO-NCP	PO-NCP
	924	1975-1993	VO-HV	VO-HV
	944	1975-1993	VO-HVP	VO-HVP
			VO-VB	VO-VB
			VO-VBP	VO-VBP
	928	1977-	PO-1P	PO-1P
PO-2P			PO-2P	



# AUTOMÓVIL - CAMIONETA

## CAR - PICK-UP TRUCKS

MARCA BRAND	MODELO MODEL					
PORSCHE	968	1993-	AU-AH	AU-AH		
			VO-AHP	VO-AHP		
PREMIER	118 NE	-	AF-7I	IMS-3		
			AF-7IP	IMS-3P		
			AF-9D	IMS-5		
			AF-9DP	IMS-5P		
			FEM-1D			
			FEM-1I			
			FEM-2D			
			FEM-2I			
			FO-FR			
			FO-FRP			
			SIP-2			
			PADMINI	-	FEM-1D	AF-4D
					FEM-1I	AF-4I
					FEM-2D	AF-5D
FEM-2I	AF-5I					
			AF-6D			
			AF-6I			
RAYTON FIS-SORE	MAGNUM 4x4	-	FI-1	FI-1		
			MAGNUM 4x4TD	-	FI-11	FI-11
			FI-11P	FI-11P		
			FI-1P	FI-1P		
	MAGNUM FORZA	-	GIQB-3P	GIQB-3P		
RENAULT	R 4	1961-1991	NE-4	NE-4		
			NE-4P	NE-4P		
			NE-4P1	NE-4P1		
			NE-4P2	NE-4P2		
	R 5	1972-1979	LMP-2	RO-15		
			LMP-2P	VA-7		
			NE-15D			
			NE-15DP			
			NE-15I			
				NE-15IP		
	R 5	1979	NE-15D	NE-16		
			NE-15DP	NE-59P		
			NE-15I			
				NE-15IP		
	R 5	1980				
	R 5	1981	CHR-3	VA-10		
	R 5	1983-1984	CHR-3P			
	R 5	1982	CHR-3	VA-10		
			CHR-3P			
			LMP-4			
			LMP-4P1			
			LMP-5			
			LMP-5P1			
R 5	1985-1986	NE-19	VA-10			
		NE-19P1				
R 5	1986-	NE-19	NE-28			



MARCA BRAND	MODELO MODEL			
RENAULT			NE-19P1	
	R 6	1968-	LMP-1	RO-15
			LMP-1P	
			NE-15I	
			NE-15IP	
	R 7	-	NE-15I	NE-16
			NE-15IP	NE-4
			NE-4	NE-4P2
			NE-4P2	NE-59P
	R 9	1981	CHR-3	NE-16
	R 11	1981	CHR-3P	NE-59P
			LMP-5	
			LMP-5P1	
	R 9	1982-1983	CHR-3	BS-5
	R 11	1982-1983	CHR-3P	NE-16
				NE-59P
				VA-10
	R 9	1984-	NE-19	NE-16
	R 11	1984-	NE-19P	NE-59P
				VA-10
				VA-17P
	R 12	1969-1971	LMP-1	RO-15
			LMP-1P	
R 12	1972-	LMP-2	VA-7	
		LMP-2P		
R 14	1976-1977	CHR-3	NE-16	
		CHR-3P	NE-59P	
		NE-15I		
		NE-15IP		
R 14	1978-1979	CHR-3	VA-7	
		CHR-3P		
R 14	1980-	CHR-3	NE-16	
		CHR-3P	NE-59P	
		LMP-4	VA-10	
		LMP-4P1		
		LMP-5		
		LMP-5P1		
R 15	1971-	NE-15I	RO-15	
R 17	1971-	NE-15IP		
R 16	1965-	NE-3	RO-15	
		NE-3P1		
		NE-3P2		
R 18	1978-1980	CHR-3	NE-16	
FUEGO	1978-1980	CHR-3P	NE-59P	
R 18	1980-1982	CHR-3	VA-10	
FUEGO	1982-	CHR-3P		
		LMP-5		
		LMP-5P1		
R 18	1983-	CHR-3	VA-10	
		CHR-3P		
		NE-19		
		NE-19P1		
		NE-22P		



MARCA BRAND	MODELO MODEL			
RENAULT	R 19	1988-1990	NE-19	NE-19
	ALPINE	1992-	NE-19P1	NE-19P1
	R 19	1990-	NE-19	NE-19
			NE-19P1	NE-19P1
			NE-36	NE-36
			NE-36P1	NE-36P1
	R 20	1975-	CHR-3	VA-17P
	R 30	1975-	CHR-3P	
			LMP-4	
			LMP-4P1	
			NE-22P	
	R 21	1986-1989	NE-19	NE-28
			NE-19P1	VA-10
	R 21	1990-1991	NE-36	NE-36
			NE-36P1	NE-36P1
	R 21	1992-	NE-38	NE-38
	R 25	1992-	NE-38P1	NE-38P1
	COACH	1995-1996		
	MEGANE	1995-1996		
	SAFRANE	1992-1995		
	R 25	1983-1988	NE-19	VA-17P
			NE-19P1	
	R 25	1989-1991	NE-36	VA-17P
			NE-36P1	
	CLIO	1990-1998	NE-36	NE-36
			NE-36P1	NE-36P1
VA-34			VA-34	
VA-34P			VA-34P	
ESPACE	1984-1997	NE-19	VA-10	
		NE-19P1		
		NE-36		
		NE-36P1		
LAGUNA	1994	NE-38	NE-38	
		NE-38P1	NE-38P1	
		VA-34	VA-34	
		VA-34P	VA-34P	
LAGUNA	1994-1995	VA-34P1	VA-34P1	
LAGUNA 2 <sup>o</sup> se.	1994	VA-34	NE-50P	
TWINGO	1993-1994	NE-36	NE-36	
		NE-36P	NE-36P	
		NE-36P	NE-36P	
		VA-34P1	VA-34P1	
TWINGO	1995	NE-36	NE-36	
		NE-36P	NE-36P	
		NE-36P	NE-36P	
		VA-34P1	VA-34P1	
RENAULT (ARGEN.)	FUEGO	-	CHR-3	NE-16
	R11	-	NE-22P	NE-59P
	R18	-		
	NEVADA	-	CHR-3	NE-28
			NE-22P	
	R 4	-	NE-3	NE-3
NE-3P			NE-3P	
NE-3P2			NE-3P2	
NE-4			NE-4	



MARCA BRAND	MODELO MODEL			
RENAULT (ARGEN.)			NE-4P	NE-4P
			NE-4P2	NE-4P2
	R 6	-	NE-3	NE-3
			NE-3P	NE-3P
			NE-3P2	NE-3P2
	R12	-	CHR-3	CHR-3
			NE-22P	NE-22P
			NE-4	NE-4
			NE-4P	NE-4P
	R19	-	NE-36	NE-36
			NE-36P1	NE-36P1
R21	-	CHR-3	NE-28	
		NE-22P	VA-10	
TRAFFIC	-	CHR-3	NE-16	
		NE-22P	NE-53	
			NE-59P	
RENAULT SAVIEM	B 70.35	-1987	CHR-3	VA-7
	B 70.45	-1987	CHR-3P	
	B 90.35	-1987	LMP-5	
	MASTER P35 D	-1987	LMP-5P1	
	MASTER T30 D	-1987	NE-22P	
	MASTER T35 D	-1987		
	B 70.45	1988-1992	CHR-3	NE-28
	B 80.45	1992-	NE-22P	
	B 90.45	1988-1992		
	B 90.50	1988-1992		
	B 110.150	1992-		
	B 110.35	1992-		
	MASTER T30 D	1987-		
	MASTER T35 D	1987-		
	MASTER TURBO	1987-		
	EXPRESS-B-D	-1987	NE-19	NE-19
			NE-19P	NE-19P
			NE-19P1	NE-19P1
	EXPRESS-B-D	1987-1991	NE-19	NE-28
	SUPERCINCO D	-1991	NE-19P1	
	JK 50-60	-	BH-1	RO-15
	JK 75-90	-	BH-1P	RO-4D
	JK 110-115	-		RO-4I
	JP 11	-	BH-1	RO-4D
	JP 13	-	BH-1P	RO-4I
	JP 13 TU	-		
	JP 115	-		
	R 11 CARGO	-1991	NE-19	VA-10
			NE-19P1	
	R 19 TD	-1992	NE-19	NE-19
			NE-19P1	NE-19P1
	R4 F4 C. 850	-1994	NE-4	NE-4
	R4 F4 C.1100	-1994	NE-4P	NE-4P
			NE-4P2	NE-4P2
	TRAFFIC	-1987	CHR-3	RO-17



# AUTOMÓVIL - CAMIONETA

## CAR - PICK-UP TRUCKS

MARCA BRAND	MODELO MODEL			
RENAULT SAVIEM			CHR-3P	
			NE-22P	
	TRAFFIC	1988-	NE-19	NE-28
			NE-19P	
ROLLS ROYCE	ALGUNOS-SOME	1995	YA-20D	YA-20D
	CLOUD	-1970		
	SHADOW	-1970		
	CLOUD	1981-1997	YA-21I	YA-21I
	SHADOW	1981-1997		
	MODELOS	1970-1973	YA-18D	YA-18D
			YA-19D	YA-19D
			YA-20I	YA-20I
	SHADOW	1971-1980	YA-21I	YA-20D
	SPIRIT	1971-1980		YA-20I
	SPUR	1971-1980		
	WRAITH	1971-1980		
	SPIRIT	1980-1983	YA-20I	YA-20I
SPUR	1980-1983	YA-21I	YA-21I	
ROVER	2000	1976-1981	LF-RO	LF-RO
	2000	1985-	LF-ROP	LF-ROP
	2300	1976-1981		
	2300	1985-		
	2400	1976-1981		
	2400	1985-		
	2600	1976-1981		
	2600	1985-		
	3500	1976-1981		
	2000	1982-1985	LF-RO	LF-RO
	2200	1982-1985	LF-ROP	LF-ROP
	2300	1982-1985	NE-11	NE-11
	2400	1982-1985	NE-11P	NE-11P
	2600	1982-1985		
	3500	1982-1985		
	2000 SC/TC	1963-1975	LF-9	UN-4
	3500	1963-1975		
	25	2000-	NE-35P2	NE-35P2
	416	1995-1996		
	620	1995-1996		
	3500 V8 S	1976-	LF-9	UN-1FS
			LF-RO	UN-4
			LF-ROP	
	820	1992-1994	NE-52P	NE-52P
	825	1992-1994		
	ALLEGRO	1973-	LF-RO	UN-FT
			LF-ROP	
ALLEGRO 2	1973-	LF-BL	UN-FT	
		LF-RO		
		LF-ROP		
ALLEGRO 3	1973-	LF-BL	UN-FT	
		LF-RO		
		LF-ROP		
		NE-11		
		NE-11P		



MARCA BRAND	MODELO MODEL			
ROVER	FX 4S (TAXI)	-	LF-BL	IN-4
			LF-RO	IN-5
			LF-ROP	
	MAESTRO	1983-	NE-11	NE-11
	SERIE 200	1985-1989	NE-11P	NE-11P
	SERIE 800	1987-1991	NE-11P1	NE-11P1
			NE-11P2	NE-11P2
			NE-24	NE-24
			NE-24P	NE-24P
			NE-24P1	NE-24P1
	MARINA	-	LF-BL	UN-FT
			LF-RO	
			LF-ROP	
			NE-1	
			NE-1P	
	MAXI	1969-	NE-1	UN-FS
	TRAVELLER	1969-	NE-1P	
	METRO	1980-1983	NE-11	NE-14
	METRO	1984-1989	NE-11P	
	MINI	1959-1973	UN-FS	UN-FS
	MINI	1974-1984	LF-BL	UN-FS
			LF-RO	
			LF-ROP	
	MINI	1985-	NE-11	UN-FS
			NE-11P1	
			NE-11P2	
	MONTEGO	1984-1988	NE-11	NE-14
			NE-11P	
			NE-24	
			NE-24P	
MONTEGO	1988-1991	NE-11	NE-11	
		NE-11P1	NE-11P1	
		NE-11P2	NE-11P2	
		NE-24	NE-24	
		NE-24P1	NE-24P1	
MONTEGO	1992-	NE-35	NE-35	
		NE-35P	NE-35P	
PRINCESS	-	NE-11	LF-RO	
		NE-11P	LF-ROP	
SERIE 100	1991-1993	NE-11	NE-11	
		NE-11P1	NE-11P1	
		NE-11P2	NE-11P2	
SERIE 200	1984	HOND-10	HOND-10	
		HOND-10P	HOND-10P	
SERIE 200	1989-1993	NE-35	NE-35	
SERIE 400	1989-1993	NE-35P2	NE-35P2	
SHERPA 185	-	LF-BL	UN-1FS	
SHERPA 230	-	LF-RO	UN-FT	
SHERPA 255	-	LF-ROP		
SAAB	93	1998	SAA-1P1	SAA-1P1
	900	1993-		
	9000	1986-		
	95	-	AS-1D	SAA-AC



MARCA BRAND	MODELO MODEL			
SAAB	96	-	SAA-AC SAA-ACP	SAA-ACP
	99	1974-1977	SAA-2P	SAA-2P
	900	1974-1977		
	900	1978-1993	SAA-AC SAA-ACP	SAA-AC SAA-ACP
SEAT	124	1970-	FI-9I FI-9IP	IMS-3 IMS-3P IMS-5 IMS-5P
	127	1972-	FI-9I	IMS-3
	131	1972-1975	FI-9IP	IMS-3P
			IMS-7	IMS-5
			IMS-7P	IMS-5P
			SIP-3	
	131	1975-	CL-7P	CL-7P
			FI-2D	FI-3D
			FI-2DP3	FI-3DP
			FI-3D FI-3DP	
	132	1973-	AF-7I	IMS-3
			AF-7IP	IMS-3P
			FI-8I	IMS-5
			FI-8IP	IMS-5P
			FO-FR	
			FO-FRP	
	CORDOBA	1993-1995	AU-AH	AU-AH
	EMELBA	1993-	AU-AHP	AU-AHP
	IBIZA	1993-1995	SE-AHP	SE-AHP
	POKER	1993-	VO-2	VO-2
	TOLEDO	1991-1995	VO-2P	VO-2P
	EMELBA	1984-1987	CL-6	CL-6
	GREDOS (GRE)	-	CL-6P	CL-6P
	IBIZA	1984-1987		
	MALAGA	1985-1990		
	POKER	1984-1987		
RONDA	1985-			
EMELBA	1988-1992	AU-HV	AU-HV	
IBIZA	1988-1992	CL-9P	CL-9P	
POKER	1988-1992	VO-HV	VO-HV	
FURA	1972-1982	CL-7P	IMS-3	
		FI-3D	IMS-3P	
		FI-3DP	IMS-5	
		FI-8I	IMS-5P	
		FI-8IP		
		IMS-7 IMS-7P		
MARBELLA	1987-1992	CL-6	IMS-3	
TERRA	-	CL-6P	IMS-3P	
			IMS-5	
			IMS-5P	
MARBELLA	1993-1997	AU-AH	AU-AH	



MARCA BRAND	MODELO MODEL			
SEAT			AU-AHP	AU-AHP
			CL-6	CL-6
			CL-6P	CL-6P
			SE-AHP	SE-AHP
			VO-2	VO-2
			VO-2P	VO-2P
	PANDA	1980-1986	FI-8I FI-8IP FI-9I FI-9IP	IMS-3 IMS-3P IMS-5 IMS-5P
	RITMO	-	CL-7P	CL-7P
	RONDA	1982-1984	FI-3D	FI-3D
			FI-3DP	FI-3DP
	TRANS	-	CL-6	IMS-3
CL-6P			IMS-3P	
FI-9I			IMS-5	
FI-9IP			IMS-5P	
SKODA	100	1982-1984	SKO-1	
	105	1982-1984	SKO-1P	
	110	1982-1984	SKO-2	
	120	1982-1984		
	110	1985-	SKO-1	
	120	1985-	SKO-1P	
	130	1985-		
	135	1985-		
	ESTELLE	1985-		
	GARD LUXE	1985-		
RAPIDE	1985-			
FAVORIT	1987-	SKO-3I	SKO-3I	
FORMAN	1987-	SKO-3IP	SKO-3IP	
SILVER	1993-			
FELICIA	1995	SKO-5P	SKO-5P	
PICK-UP	1995			
MODELOS	1964-1981	SKO-8	SKO-4	
SSANGYONG	KORANDO	2000-	HY-5	HY-5
			HY-5P	HY-5P
	MUSSO	1995-	HY-3P2	HY-3P2
STERLING	SERIE 800	-	NE-11	
			NE-11P	
			NE-24	
			NE-24P	
STEYR-PUCH	19 S31	-1994	NE-58D	
	19 S37	-1994		
	26 S31	-1994		
	32 S31	-1994		
	230	-1979	ME-HZ	ME-HZ
	240	-1979	ME-HZP	ME-HZP
	280	-1979		
	300	1979-		
	230	1979-	ME-HF	ME-HF
	240	1979-	ME-HFP	ME-HFP
280	1979-	ME-HM	ME-HM	
		ME-HMP	ME-HMP	



# AUTOMÓVIL - CAMIONETA

## CAR - PICK-UP TRUCKS

MARCA BRAND	MODELO MODEL			
STEYR-PUCH	PANDA 4x4	1983-1985	AF-7I	IMS-3
			AF-7IP	IMS-3P
			FI-9I	IMS-5
			FI-9IP	IMS-5P
	PANDA 4x4	1986-1988	FI-1	IMS-3
			FI-11	IMS-3P
			FI-11P	IMS-5
			FI-1P	IMS-5P
	PANDA 4x4	1989-	FI-1	FI-1
			FI-11	FI-11
			FI-11P	FI-11P
			FI-1P	FI-1P
SUBARU	ALCYONE	1986-	DAT-6	DAT-6
	E10 VAN	1986-	DAT-6D	DAT-6D
	E12 VAN	1986-	DAT-6DP	DAT-6DP
	E5 VAN	1986-	DAT-6DP1	DAT-6DP1
	E7 VAN	1986-	DAT-6P	DAT-6P
	HUNTER	1986-	DAT-6P1	DAT-6P1
	JUSTY (EU)	1986-1996		
	L 1.3	1986-		
	L 1.6	1986-		
	L 1.8	1986-		
	LEGACY 4WD	1986-1996		
	LEONE	1986-		
	M 70	1986-		
	M 80	1986-		
	SAMBAR VAN	1986-		
	XT	1986-		
	E10 DOMINGO	1984-1985	DAT-11D	DAT-8I
	JUSTY	1984-1985	DAT-11DP	DAT-8IP
	L 1.3	1984-1985	WAS-2P	DAT-8IP1
	L 1.6	1984-1985		
	L 1.8	1984-1985		
	M 70	1984-1985		
	M 80	1984-1985		
	REX	1984-1985		
	HATCBACK	1985-	DAT-6	DAT-6
	JUSTY XT	1985-1996	DAT-6P	DAT-6P
	LEGACY	1985-1996	DAT-6P1	DAT-6P1
	LOYALE	1985-	DAT-7	DAT-7
			DAT-7P	DAT-7P
	IMPREZA	1995	DAT-6	DAT-6
			DAT-6P1	DAT-6P1
	JUSTY	1991-1996	DAT-6	DAT-7
			DAT-6P1	
	LEONE	1973-1982	DAT-11D	DAT-1D
	REX	1973-1982	DAT-11DP	DAT-1DP
	SEDAN	1973-1982	WAS-2P	DAT-1I
	TIGRE	1973-1982		DAT-1IP
				DAT-2D
				DAT-2DP
				DAT-2I
				DAT-2IP

MARCA BRAND	MODELO MODEL				
SUBARU	LEONE	1983-1984	DAT-11D	DAT-2I	
	REX	1983-1984	DAT-11DP	DAT-2IP	
	SEDAN	1983-1984	WAS-2P		
	TIGRE	1983-1984			
	MODELOS	1970-1972	DAT-1I	DAT-1I	
			DAT-1IP	DAT-1IP	
	MODELOS	2000-	DAT-15	DAT-15	
	SULKY	50	-1991	BH-4	ZA-1
		125	-1991		ZA-1P
	SUNBEAM	1.0	-	LF-SL	LF-SL
1.3		-	LF-SLP	LF-SLP	
1.6		-			
SUZUKI	ALTO	1976-1984	TOYO-14	TOYO-14	
	CERVO	1976-1984	TOYO-14P	TOYO-14P	
	CULTUS	1976-1984			
	ESTEEM	1976-1984			
	FRONTE	1976-1984			
	GOLD FINGER	1976-1984			
	JIMMY	1976-1984			
	S.CARRY	1988			
	SAMURAI	1976-1984			
	SJ 30	1976-1984			
	SJ 310	1976-1984			
	SJ 410	1976-1984			
	SJ 413	1976-1984			
	VITARA	1988			
	ALTO	1986-1995	SUZU-7	SUZU-7	
	CERVO	1986-	SUZU-7P	SUZU-7P	
	CULTUS	1986-			
	ALTO	1996	SUZU-8	SUZU-8	
	CARRY VAN	1989-1991	SUZU-8P	SUZU-8P	
	EVERY VAN	1989-1991			
	SWIFT	1989-1991			
	VITARA	1989-1991			
	VITARA	1991			
	X-90	1995-1997			
	BALENO	1995	SUZU-10	SUZU-10	
	ESCUDO	1989-1991	SUZU-10P	SUZU-10P	
SIDEKICK	1989-1991				
SWIFT	1991-1996				
CULTUS	1984-1991	MIT-2I	MIT-2I		
SAMURAI	1984-1989	TOYO-14	TOYO-14		
		TOYO-14P	TOYO-14P		
LJ 50	1970-	TOYO-14	TOYO-14		
LJ 80	1970-	TOYO-14P	TOYO-14P		
		TOYO-K1	TOYO-K1		
		TOYO-K1P	TOYO-K1P		
SAMURAI	1989-	IMS-11P	IMS-11P		
		SUZU-9P	SUZU-9P		
SJ 410	1985-1988	IMS-7	IMS-10		
SJ 413	1985-1988	IMS-7P			
SJ 410	1989-1991	IMS-7	IMS-11P		



MARCA BRAND	MODELO MODEL			
SUZUKI	SJ 413	1989-1991	IMS-7P	SUZU-9P
TALBOT SIMCA	150	1975-	LMP-3	LMP-3
	1510	1975-	LMP-3P	LMP-3P
	ALPINE	1975-		
	HORIZON	1980-1983		
	MINX	1980-1983		
	OMNI	1980-1983		
	RAPIER	1975-		
	160 GT	1979-	CHR-3	CHR-3
	180	1979-	NE-22P2	NE-22P2
	1307	1975-		
	1308	1975-		
	1309	1978-		
	HORIZON	1984-		
	MINX	1984-		
	MURENA	1980-		
	OMNI	1984-		
	1000	1968-1973	NE-3	RO-3
	1005	1968-1973	NE-3P1	
	1006	1968-1973	NE-3P2	
	1007	1968-1973		
	1100	1968-1973		
	1301	1970-1973		
	1501	1970-		
	1100	1974-	CHR-3 NE-22P2	RO-3
	BAGHEERA	1973-	NE-3 NE-3P1 NE-3P2	
	HORIZON	1977-1979	CHR-3	CHR-3
	HORIZON GL	1977-1979	NE-22P2	LMP-3
	MINX	1977-1979		LMP-3P
	OMNI	1977-1979		NE-22P2
	RANCH	1977-	CHR-3 NE-22P2	
	RAPIER	1980-	CHR-3	CHR-3
	SAMBA	1981-1983	NE-22P2	NE-22P2
	SOLARA	1980-	NE-33P1	NE-33P1
	TAGORA	1980-		
	SAMBA	1984-	CHR-3 NE-22P2 NE-33P1	CHR-3 NE-22P2 VA-6 VA-6P
TATA	INDICA	2000-	TAT-1D TAT-1DP	TAT-1D TAT-1DP
TOYOTA	3 DR LIFT B.	1988-1989	TOYO-12	TOYO-12
	4 RUNNER	1988-1989	TOYO-12P1	TOYO-12P1
	CELICA	1988-1989	TOYO-8	TOYO-8
	COROLLA	1988-1989	TOYO-8P	TOYO-8P
	MR2	1989-1990		
	SUPRA EFI SR	1988-1989		
	TERCEL	1989-		
	4 RUNNER	1970-1986	TOYO-12	TOYO-12



MARCA BRAND	MODELO MODEL			
TOYOTA	L. CRUISER	1970-1986	TOYO-12P1	TOYO-12P1
			TOYO-2	TOYO-2
			TOYO-K1	TOYO-K1
			TOYO-K1P	TOYO-K1P
	4 RUNNER	1986-1988	TOYO-16	TOYO-16
	CAMRY	1990-1991	TOYO-16P	TOYO-16P
	DYNA	1990-	TOYO-16P1	TOYO-16P1
	L. CRUISER	1986-1989	TOYO-5	TOYO-5
	LITEACE	1990-	TOYO-5P	TOYO-5P
	RUNNER	1986-1989	TOYO-5P1	TOYO-5P1
	STARLET	1990-1997		
	VX TURBO	1986-1989		
	4 RUNNER	1990-1991	TOYO-20D	TOYO-20D
	CARINA	1990-1994	TOYO-9	TOYO-9
	CELICA COUPE	1991-1996	TOYO-9P	TOYO-9P
	COROLLA	1990-1991	TOYO-9P1	TOYO-9P1
	CRESSIDA	1990-		
	HIACE VAN	1990-		
	HILUX 4x4	1995		
	HILUX VAN	1990-		
	L. CRUISER	1990-1991		
	MR2	1991-1997		
	RUNNER	1990-1991		
	4 RUNNER	1991-	TOYO-15	TOYO-15
	CAMRY	1991-	TOYO-15P	TOYO-15P
	CARINA S.W.	1995		
	CELICA	1995		
	COROLLA	1991-1996		
	RAV4	1995		
	RUNNER	1991-		
	ARROW	1970-1972	TOYO-4	TOYO-4
	CELICA SUPRA	1982-1985	TOYO-4P	TOYO-4P
	CROWN	1970-1972		
	CAMRY	1984-1989	TOYO-13 TOYO-13P1 TOYO-28P	TOYO-13 TOYO-13P1 TOYO-28P
	CAMRY GL	1984-	TOYO-3	TOYO-3
	CAMRY GLI	1984-	TOYO-3P	TOYO-3P
	CARINA	1983-1985	TOYO-8	TOYO-8
	COROLLA	1975-1982	TOYO-8P	TOYO-8P
	COROLLA 4DR	1986-1996		
	CORONA	1983-1985		
	CORSA	1983-1985		
	CRESSIDA	1983-1985		
	CRESTA	1983-1985		
	CROWN	1983-1985		
	MARK II	1983-1985		
	MR2	1983-1985		
	SPRINTER	1983-1985		
	TERCEL	1983-1985		
	CARINA	1972-1982	TOYO-14	TOYO-14
	CELICA	1972-1982	TOYO-14P	TOYO-14P
	COROLLA	1972-1974	TOYO-K1	TOYO-K1









# AUTOMÓVIL - CAMIONETA

## CAR - PICK-UP TRUCKS

MARCA BRAND	MODELO MODEL			
TOYOTA	CORONA	1972-1974	TOYO-K1P	TOYO-K1P
	CROWN	1972-1982		
	HIACE	1975-1982		
	HILUX	1973-1978		
	MARK II	1972-1982		
	PUBLICA	1972-1974		
	STARLET	1972-1982		
	CARINA	1985-1986	TOYO-3	TOYO-3
	CORONA	1985-1986	TOYO-3P	TOYO-3P
	SPRINTER	1985-1986		
	TERCEL 4WD	1985-1986		
	CARINA	1994	TOYO-19P	TOYO-19P
	CELICA	1983-1985	TOYO-12	TOYO-12
			TOYO-12D	TOYO-12D
			TOYO-12P1	TOYO-12P1
			TOYO-22	TOYO-22
			TOYO-22D	TOYO-22D
			TOYO-3	TOYO-3
			TOYO-3P	TOYO-3P
			TOYO-8	TOYO-8
			TOYO-8P	TOYO-8P
			TOYO-K1	TOYO-K1
			TOYO-K1P	TOYO-K1P
	CELICA	1986-1988	TOYO-10	TOYO-10
	COROLLA ST	1988-1989	TOYO-10P	TOYO-10P
	TERCEL	1987-1988	TOYO-11	TOYO-11
			TOYO-11P	TOYO-11P
	CELICA	1990-1995	TOYO-10	TOYO-10
			TOYO-10P	TOYO-10P
			TOYO-10P1	TOYO-10P1
			TOYO-11	TOYO-11
			TOYO-11P	TOYO-11P
			TOYO-11P1	TOYO-11P1
			TOYO-20D	TOYO-20D
			TOYO-9	TOYO-9
			TOYO-9P	TOYO-9P
			TOYO-9P1	TOYO-9P1
	CELICA 4WD	1990-1991	TOYO-10	TOYO-10
	MR2	1990-1991	TOYO-10P	TOYO-10P
	PREVIA	1993-1997	TOYO-10P1	TOYO-10P1
			TOYO-11	TOYO-11
			TOYO-11P	TOYO-11P
			TOYO-11P1	TOYO-11P1
	CELICA COUPE	1991-1994	TOYO-37D	TOYO-37D
	CELICA LIFT.	1991-1996	TOYO-10	TOYO-10
		TOYO-10P1	TOYO-10P1	
COROLLA	1983-1987	TOYO-12	TOYO-12	
TERCEL	1985-1987	TOYO-12P1	TOYO-12P1	
		TOYO-22	TOYO-22	
		TOYO-22D	TOYO-22D	
		TOYO-K1	TOYO-K1	
		TOYO-K1P	TOYO-K1P	
COROLLA 5	1972-1976	TOYO-2	TOYO-2	



MARCA BRAND	MODELO MODEL			
TOYOTA			TOYO-4	TOYO-4
			TOYO-4P	TOYO-4P
	COROLLA DX	1985-1996	TOYO-23	TOYO-23
	CRESSIDA	1977-1978	TOYO-23P	TOYO-23P
	CRESTA	1977-1978		
	COROLLA GT	1985-1996	TOYO-8	TOYO-8
			TOYO-8P	TOYO-8P
	COROLLA SM	1973-1978	TOYO-14	TOYO-14
			TOYO-14P	TOYO-14P
			TOYO-4	TOYO-4
			TOYO-4P	TOYO-4P
			TOYO-K1	TOYO-K1
			TOYO-K1P	TOYO-K1P
	COROLLA SW	1993-1996	TOYO-17	TOYO-17
			TOYO-17P	TOYO-17P
	CRESSIDA	1984-1987	TOYO-28P	TOYO-28P
	CRESSIDA	1985-1987	TOYO-13	TOYO-13
			TOYO-13P1	TOYO-13P1
	FX 16	1987-1988	TOYO-K1	TOYO-K1
	STARLET	1984-1990	TOYO-K1P	TOYO-K1P
	HDJ 80	1991-	TOYO-18P	TOYO-18P
	L. CRUISER	1991-		
	PASEO	1991-1997	TOYO-10	TOYO-10
			TOYO-10P	TOYO-10P
			TOYO-10P1	TOYO-10P1
VARIOS	-1969	TOYO-25	TOYO-25	
VARIOS	1970-	TOYO-29	TOYO-29	
TRABANT	TODOS	-	DOB-1	DOB-1
			DOB-1D	DOB-1D
			DOB-2	DOB-2
			DOB-2D	DOB-2D
			DOB-3	DOB-3
			DOB-3D	DOB-3D
TRIUMPH	ACCLAIM	1981-	HOND-1	HOND-1
			HOND-1P	HOND-1P
			HOND-2	HOND-2
			HOND-2P	HOND-2P
DOLOMITE	1973-	UN-NH	UN-FS	
TOLEDO	1973-	UN-NHP		
GT6 MK3	-	FO-FR	UN-NH	
		FO-FRP	UN-NHP	
		UN-NH		
		UN-NHP		
		WAS-2P		
GTX MK3	1972	FO-FR	UN-NH	
SPITFIRE	1972-1974	FO-FRP	UN-NHP	
SPITFIRE MK4	1972	WAS-2P		
MODELOS	-1969	UN-FS	UN-44	
			UN-FP	
SPITFIRE	1974-1978	LF-WB	UN-NH	
		LF-WBP	UN-NHP	
SPITFIRE	1979-	UN-NH		
		UN-NHP		



MARCA BRAND	MODELO MODEL			
TRIUMPH	TR6 PJ SPID.	1969-1977	FO-FR FO-FRP WAS-2P	UN-FT UN-NH UN-NHP
	TR7 COUPE	1975-1981	UN-NH	UN-FT
	TR7 SPIDER	1975-1981	UN-NHP	UN-NH UN-NHP
UAZ	452	-	BH-1	IMS-3
	469	-	BH-1P	IMS-3P
	469 DIESEL	-	VOL-2	IMS-5
			VOL-3	IMS-5P VOL-2 VOL-3
	FURGON 4R.M	-	VOL-2	IMS-3
				IMS-3P
IMS-5 IMS-5P				
ROAD MASTER	-	BS-6		
VAUXHALL	ASTRA	1975-1979	OP-J	OP-J
	CHEVRETTE	1975-1979	OP-JP	OP-JP
	ASTRA	1984-1995	OP-D	OP-D
	ASTRAMAX	1984-	OP-DP	OP-DP
	BELMONT	1984-	OP-S	OP-S
	NOVA	1984-	OP-SP	OP-SP
	ROYALE	1984-		
	CARLTON	1978-1981	OP-R	OP-R
	VICEROY	1978-1989	OP-RP	OP-RP
			OP-T	OP-T
			OP-TP	OP-TP
	CARLTON	1982-	OP-WHP	OP-WHP
	CAVALIER	1982-	OP-WYP	OP-WYP
	SENATOR	1982-		
	CAVALIER	1975-1981	OP-AB	OP-AB
			OP-ABP	OP-ABP
			OP-BA	OP-BA
			OP-BAP	OP-BAP
			OP-J	OP-J
OP-JP			OP-JP	
FIRENZA	-	LF-RO LF-ROP	LF-6	
VOLGA	GAZ 024	-	VOL-1	VOL-1
			VOL-1P	VOL-1P
	GAZ 029	-	NE-3	VOL-1
			NE-3P	VOL-1P
			NE-3P2	VOL-2 VOL-2D VOL-3
				VOL-1
				VOL-1P
	GAZ 3110	-	NE-3P2	VOL-4 VOL-5P
VOLKSWAGEN	411	1970-1972	VO-K	
	412	1970-1972		
	1500	1970-1972		



MARCA BRAND	MODELO MODEL			
VOLKSWAGEN	1600	1970-1972		
	BRASILIA	1970-1972		
	411	1973-1974	VO-VB	VO-VB
	412	1973-1974	VO-VBP	VO-VBP
	BRASILIA	1973-1974		
	CABRIOLET	1975-1981		
	DERBY AMAZON	1977-1980		
	FAMILCAR	1977-1980		
	GOLF	1977-1980		
	IGALA	1973-1974		
	PASSAT	1973		
	PASSAT	1977-1980		
	POLO	1975-1976		
	POLO	1977-1980		
	SCIROCCO	1975-1981		
	1303 CABRIO	1970-	HU-SU	VO-M VO-MP
	ALL STAR	1991-	VO-2	VO-2
	CALIFORNIA	1991-	VO-2P	VO-2P
	CLUB VAN	1991-		
	POLO	1991-1995		
	SINCRO	1991-		
	TRANSPORTER	1991-1995		
	BEETLE	1970-1978	VO-M	VO-M
	EL VOLKSWAGE	1970-1978	VO-MP	VO-MP
	ESCARABAJO	1970-1978		
	FUSCA	1970-1978		
	CADDY	-	AU-1	AU-1
	POLO	1981-1982	AU-HV	AU-HV
			AU-HVP	AU-HVP
			VO-HV VO-HVP	VO-HV VO-HVP
	CORRADO	1988-	AU-AN	AU-AN
	GOLF	1988-1990	AU-ANP	AU-ANP
GOLF	1991-1995	HU-AN	HU-AN	
JETTA ATLAN.	1988-	VO-2	VO-2	
PASSAT	1988-1995	VO-2P	VO-2P	
VENTO	1992-1995			
DERBY AMAZON	1981-1982	AU-1	AU-1	
DERBY AMAZON	1985-1987	AU-HV	AU-HV	
GOLF	1981-1982	AU-HVP	AU-HVP	
GOLF	1985-1987	VO-HV	VO-HV	
GOLF CABRIO	1981-1984	VO-HVP	VO-HVP	
JETTA ATLAN.	1981-1984	VO-VB	VO-VB	
JETTA ATLAN.	1985-1987	VO-VBP	VO-VBP	
PASSAT	1981-1984			
PASSAT	1985-1987			
POLO	1985-1991			
SANTANA	1981-1982			
SCIROCCO	1981-1982			
SCIROCCO	1985-1987			
GOLF	1975-1977	VO-VB	HU-SU VO-VB	
		VO-VBP	VO-VB	



# AUTOMÓVIL - CAMIONETA

## CAR - PICK-UP TRUCKS

MARCA BRAND	MODELO MODEL				
VOLKSWAGEN				VO-VBP	
	GOLF	1987-1988	VO-2 VO-2P VO-AHP	VO-2 VO-2P VO-AHP	
	K 70	1970-1973	FO-PN	FO-PN	
	K 70 LS	1970-1973	VO-VB VO-VBP	VO-VB VO-VBP	
	LT 28D	1970-1979	VO-R	VO-R	
	LT 31	1970-1979	VO-RP	VO-RP	
	PASSAT FAM.	1973-1976			
	TL 31	1970-1979			
	TL 45	1970-1979			
	TL 50	1970-1979			
	MODELOS	1966-1969	FO-D VO-L	VO-L	
	TARO NISSAN	1989-	TOYO-20D TOYO-9 TOYO-9P TOYO-9P1	TOYO-20D TOYO-9 TOYO-9P TOYO-9P1	
	TL 31	1980-	VO-N	VO-N	
	TL 35	1980-	VO-NP	VO-NP	
	TL 45	1980-			
	TL 50	1980-			
	TRANSPORTER	1980-1991			
	VAGON	1980-			
	VOLKSWAGEN (ARGEN.)	1500	-		CHR-8 CHR-8P
		1500	1980-		
1800		1980-			
GACEL		-	VO-FHP1	VO-FHP1	
GOL		-1995	VO-FHP1 VO-VB VO-VBP	VO-FHP1 VO-VB VO-VBP	
GOL		1996	VO-2DP	VO-2DP	
GOL		1997-	VO-8P	VO-8P	
KOMBI		-	VO-R VO-RP	VO-R VO-RP	
POINTER		-	VO-5P	VO-5P	
SAVEIRO		-	VO-HV VO-HVP VO-VB VO-VBP	VO-HV VO-HVP VO-VB VO-VBP	
SENDA		-	VO-HV VO-HVP	VO-HV VO-HVP	
VOLKSWAGEN (BRASIL)		FOX	1975-1976	VO-VB	VO-VB
		FOX	1977-1980	VO-VBP	VO-VBP
		GOL	1975-1976		
		GOL	1977-1980		
	PARATI	1973			
	PARATI	1977-1980			
	QUANTUM	1973			
	QUANTUM	1977-1980			
	FOX	1981-1982	AU-1	AU-1	

MARCA BRAND	MODELO MODEL					
VOLKSWAGEN (BRASIL)	GOL	1981-1982	AU-HV AU-HVP VO-HV VO-HVP	AU-HV AU-HVP VO-HV VO-HVP		
	FOX	1985-1991	AU-1	AU-1		
	GOL	1985-1991	AU-HV	AU-HV		
	PARATI	1981-1984	AU-HVP	AU-HVP		
	PARATI	1985-1987	VO-HV	VO-HV		
	QUANTUM	1981-1984	VO-HVP	VO-HVP		
	QUANTUM	1985-1987	VO-VB	VO-VB		
	SANTANA	1981-1982	VO-VBP	VO-VBP		
	FOX	1991-	VO-2	VO-2		
	GOL	1991-	VO-2P	VO-2P		
	PARATI	1988-	AU-AN	AU-AN		
	QUANTUM	1988-	AU-ANP HU-AN VO-2 VO-2P	AU-ANP HU-AN VO-2 VO-2P		
	VARIOS	1996-	VO-2DP1 VO-2P1 VO-8P1	VO-2DP1 VO-2P1 VO-8P1		
	VOLKSWAGEN (CHINA)	SHANGHAI	1973	VO-VB	VO-VB	
		SHANGHAI	1977-1980	VO-VBP	VO-VBP	
		SHANGHAI	1981-1984	AU-1	AU-1	
		SHANGHAI	1985-1987	AU-HV AU-HVP VO-HV VO-HVP VO-VB VO-VBP	AU-HV AU-HVP VO-HV VO-HVP VO-VB VO-VBP	
		SHANGHAI	1988-	AU-AN AU-ANP HU-AN VO-2 VO-2P	AU-AN AU-ANP HU-AN VO-2 VO-2P	
		VOLKSWAGEN (MEXICO)	ESCARABAJO	-	VO-M VO-MP	VO-M VO-MP
			VOLVO	66 DL	1972-1976	
66 GL		1972-1976				
66 L		1972-1976				
66 MARATHON		1972-1976				
66 SL	1972-1976					
142	1968-1972	NE-13		UN-FR		
144	1968-1972					
145	1968-1972					
164	1968-1972					
142	1973-1976	NE-10		NE-9		
144	1973-1976	NE-10P		NE-9P		
145	1973-1976			WAS-1		
164	1973-1976					
240	1973-1976					

MARCA BRAND	MODELO MODEL			
VOLVO	242	1973-1976		
	244	1973-1976		
	264	1973-1976		
	240	1977-1978	NE-12	NE-9
	242	1977-1978	NE-12P	NE-9P
	244	1977-1978		
	245	1977-1978		
	246	1977-1978		
	262	1977-1978		
	264	1977-1978		
	265	1977-1978		
	240	1978-1984	NE-12	NE-12
	242	1978-1983	NE-12P	NE-12P
	244	1978-1983		
	245	1978-1983		
	262	1978-1983		
	264	1978-1983		
	265	1978-1983		
	240	1984-1985	NE-12	NE-12
	740	1986-1991	NE-12P	NE-12P
	760	1984-1987	NE-18	NE-18
	780	1986-1991	NE-18P	NE-18P
	940	1991-1996		
	340	1976-1984	HU-DF	AKS-1
	343	1976-1984	HU-DFP	
	345	1976-1984	HU-DFP1	
	360	1976-1984		
	340	1985-1986	HU-DF	HU-DF
	360	1985-1986	HU-DFP	HU-DFP
			HU-DFP1	HU-DFP1
	440	1987-	HU-DHP	HU-DHP
	460	1987-	HU-DNP	HU-DNP
	480	1987-		
	760	1991-	NE-40	NE-40
	762	1991-	NE-40P	NE-40P
	764	1991-	NE-41P	NE-41P
	765	1991-		
	960	1991-1996		
	850	1991-1996	NE-40	NE-40
			NE-40P	NE-40P
AMAZON 140	-1973	NE-13	UN-4	
		NE-56	UN-FP	
			UN-FS	
FH 12	1997	HU-DHP	HU-DHP	
PV AMAZON	-	AS-11	HUD-1	
		AS-24		
WARTBURG	MODELOS	-	DOB-1	DOB-1
			DOB-1D	DOB-1D
			DOB-2	DOB-2
			DOB-2D	DOB-2D
			DOB-3	DOB-3
			DOB-3D	DOB-3D

MARCA BRAND	MODELO MODEL			
YUGO-ZASTAVA	101	1971-1982	FO-FR	IMS-3
	311	1971-1982	FO-FRP	IMS-3P
	411	1971-1982		IMS-5
	413	1971-1982		IMS-5P
	511	1971-1982		
	513	1971-1982		
	KORAL	1987-	FI-6I	FI-3D
	YUGO 45	1987-	FI-6IP3	FI-3DP
	YUGO 55	1987-		FI-3DP5
	YUGO 65	1987-		
	YUGO 45	1982-1984	FI-6I	FI-6I
	YUGO 55	1982-1984	FI-6IP3	FI-6IP3
			FO-E-TC	IMS-3
			FO-E-TCP	IMS-3P
			FO-FR	IMS-5
			FO-FRP	IMS-5P
				SIP-1
	YUGO 45	1985-1986	FI-6I	YU-1D
	YUGO 55	1985-1986	FI-6IP3	
	YUGO 65	1985-1986		
YUGO 45	1986-1987	FI-6I	IMS-3	
YUGO 55	1986-1987	FI-6IP3	IMS-3P	
YUGO 65	1986-1987		IMS-5	
			IMS-5P	
ZAZ	966	-	NE-3	VOL-3
	968 A	-	NE-3P	
	968 M	-	NE-3P1	
			NE-3P2	
	TAVRIA	-	NE-3	AF-19
			NE-3P	AF-19P
		NE-3P1		
		NE-3P2		

**CAMIÓN**

KAMIONA

TRUCKS

CAMION

LKW









**THE KEY TO EXCELLENCE**  
GLOBALLY UNLOCKING MILLIONS OF DOORS DAILY









### CAMIÓN

KAMIOIA • TRUCKS • CAMION • LKW

MARCA BRAND	MODELO MODEL			
ASTRA	BM 64.26	-	AF-7I	IMS-3
	BM 64.30	-	AF-7IP	IMS-3P
	BM 64.36	-	AF-8D	IMS-5
	BM 66.30	-	AF-8DP	IMS-5P
	BM 66.36	-	AF-8I	
	BM 201	-	AF-8IP	
	BM 305	-	AF-9D	
			AF-9DP	
			AF-9I	
			AF-9IP	
BEDFORD	CF	-1980	LF-9	UN-1FS
			LF-RO	
			LF-ROP	
			NE-10	
			NE-10P	
	CF	1980-	NE-10	UN-FT
	CF 2 250 D	1980-	NE-10P	WAS-6
	CF 2 350 D	1980-		WAS-6P
	TL 560	-	NE-1	LF-6
	TL 860	-	NE-10	
TL 1260	-	NE-10P		
TM	-	NE-1P		
BROCKWAY	VARIOS	1966-	BS-4D	BS-4D
			YA-8D	YA-8D
			YA-8I	YA-8I
DAF	2800	-	CHR-3	FO-OA
	3600	-	CHR-3P	
	FA 2100 DT	-		
	FA 2105	-		
	FA 2505	-		
	FA 2805	-		
	FA 3605	-		
	FAS 3605	-		
	FAT 2826	-		
	FAT 3626	-		
	FT 2505	-		
	FT 2805	-		
	FT 3605	-		
	FTT 2826	-		
	FTT 3626	-		
	2800 T. IN.	-1984	NE-3	FO-OA
	FA 1100	1980-1982	NE-3P	
	FA 1300 T	1980-1982	NE-3P1	
	FA 2100	1980-1982	NE-3P2	
	FA 2500	1980-1982		
	F 1100	1985-1991	CHR-3	FO-OA
	F 1300	1985-1991	NE-22P2	
	F 1700	1985-1991		

MARCA BRAND	MODELO MODEL			
DAF	F 1900	1985-1991		
	F 2100	1985-1991		
	F 2500	1985-1991		
	F 3626	1985-1991		
	FA 1100 DT	-	DAV-1	RO-4D
	FA 1300 DNT	-	DAV-1P	RO-4I
	FA 1300 DT	-		
	FA 2100	1982-1984		
	FA 2500	1982-1984		
	FA 2500	-	CHR-3	FO-OA
			CHR-3P	
			NE-3	
			NE-3P	
			NE-3P1	
			NE-3P2	
	F-FA-V- 600	1985-1991	NE-11	FO-OA
	F-FA-V- 800	1985-1991	NE-11P	
	F-FA-V-1000	1985-1991		
	FT 75.270R	-	CHR-3	VO-VB
	FT 85.360W	-	NE-22P	VO-VBP
	FT 3300	-		
	SERIE FT	1991-	CHR-3	VO-VB
			CHR-3P	VO-VBP
	V 400	1991-	NE-11	NE-11
	V 600	1991-	NE-11P	NE-11P
DIAMOND REO	VARIOS	1960-	HUD-1	HUD-1
FIAT IVECO	30.8	-1991	FI-11	FI-11
	35.10	-1991	FI-11P	FI-11P
	35.8	-1991	FI-1P	FI-1P
	40.10	-1991		
	49.10	-1991		
	30.8	1992-	FI-12	FI-11
	35.10	1992-	FI-12P1	FI-11P
	35.12	1992-		
	35.8	1992-		
	40.10	1992-		
	40 NC 35	-	AF-9D	AF-5D
	40.8 F 8	-	AF-9DP	AF-5I
			AF-9I	AF-6D
			AF-9IP	AF-6I
	50 NC	-	AF-9D	IMS-3
55	-	AF-9DP	IMS-3P	
55 NC	-	AF-9I	IMS-5	
80 NC	1979-	AF-9IP	IMS-5P	
		FEM-1D		
		FEM-1I		
50.10 F 10	1979-	LF-RO	IMS-3	
55.8 F 8	1979-	LF-ROP	IMS-3P	
60.10 F 10	1979-	SIP-1	IMS-5	



MARCA BRAND	MODELO MODEL			
FIAT IVECO	65.10 F 10	1979-		IMS-5P
	70.10 F 10	1979-		
	79.10 F 10	1979-		
	79.13 F 13	1979-		
	79.14 F 14	1979-		
	80.13 F 13	1979-		
	95.14 F 14	1979-		
	100	1979-		
	50.9	-1994	FI-6I	IMS-3
	60.11	-1994	FI-6IP1	IMS-3P
	65.12	-1994	FI-9I	IMS-5
	79.14	-1994	FI-9IP	IMS-5P
	80.14	-1994		
	95.14	-1994		
	109.14	-1994		
	110.17	-1994		
	100	1981-	AF-8D	IMS-3
	110	1981-	AF-8DP	IMS-3P
	110 NC	1981-	AF-8I	IMS-5
	110 P	1981-	AF-8IP	IMS-5P
	130	1981-	AF-9D	
	150.20	1981-	AF-9DP	
	160 NC	1981-	AF-9I	
	170 NC 35	1981-	AF-9IP	
			FEM-1D	
			FEM-1I	
	115.17 D T.	-1989	FI-6I	FI-6I
	115.17 H	-1989	FI-6IP	FI-6IP
	135	-1989		
	145.17 H T.	-1989		
	175.24	-1989		
	150 R.20	-	AF-9D	FI-5D
	150 T.20	-	AF-9DP	FI-5I
	159.20	-	AF-9I	IMS-3
	190	-1989	AF-9IP	IMS-3P
	190 T.30	-1989		IMS-5
	190.26	-1989		IMS-5P
	180	-1989	AF-7I	IMS-3
	180.26	-1989	AF-7IP	IMS-3P
	180.26 T	-1989	AF-9D	IMS-5
	190.38	-1989	AF-9DP	IMS-5P
	190.38 T	-1989	AF-9I	
	190.F 35	-1989	AF-9IP	
	190.H 35	-1989		
	190 PC 26	-	BH-2	PRE-1I
260	-			
190 TURBOS.	1989-1991	AU-1	FI-11	
		AU-HV	FI-11P	
		AU-HVP		
190.26	-1991	FI-11	NE-1	
190.30	-1991	FI-11P	NE-1P	
190.32	-1991			
190.36	-1991			
190.42	-1991			



MARCA BRAND	MODELO MODEL			
FIAT IVECO	190.48	-1991		
	240.26	-1991		
	240.32	-1991		
	240.36	-1991		
	280.36	-1991		
	330.30	-1991		
	330.35	-1991		
	330.36	-1991		
	190.26	1992-	FI-11	FI-11
	190.30	1992-	FI-11P	FI-11P
	190.32	1992-		
	190.36	1992-		
	190.42	1992-		
	190.48	1992-		
	240.26	1992-		
	240.32	1992-		
	240.36	1992-		
	280.36	1992-		
	330.30	1992-		
	330.35	1992-		
	330.36	1992-		
	190.30	-1989	AF-7I	FI-5D
			AF-7IP	FI-5I
			AF-9D	IMS-3
			AF-9DP	IMS-3P
			AF-9I	IMS-5
			AF-9IP	IMS-5P
	190.33 T.S.	-1988	VO-VB	FI-11
	190.38 T.S.	-1988	VO-VBP	FI-11P
	190.42 T.S.	-1988		
	242 E-15	1985-	FI-3D	IMS-3
	242 E-18	1985-	FI-3DP3	IMS-3P
				IMS-5
				IMS-5P
	242.15	-1984	CT-1	IMS-3
	242.18	-1984	CT-1P	IMS-3P
			CT-3	IMS-5
			CT-3P	IMS-5P
	260.36	1992-	FI-11	VO-VB
	260.48	1992-	FI-11P	VO-VBP
	330 F 35	-1988	VO-VB	IMS-3
	330.26	-1988	VO-VBP	IMS-3P
	330.30	-1988		IMS-5
	330.32	-1988		IMS-5P
	330.35	-1988		
330.36	-1988			
619.3A	-	AF-9D	AF-9D	
619.N	-	AF-9DP	AF-9DP	
642	-	AF-9I	AF-9I	
		AF-9IP	AF-9IP	
643	-	AF-9D	AF-5D	
672	-	AF-9DP	AF-5I	
		FEM-1D	AF-6D	
		FEM-1I	AF-6I	









# CAMIÓN

## TRUCKS

MARCA BRAND	MODELO MODEL			
FORD	A 0406	-	FO-E-TC	UN-FT
	A 0406 R	-	FO-E-TCP	
	A 0509	-	FO-TX	
	A 0509 P	-	FO-TXP	
	A 0609	-	UN-FT	
	D 710 CUSTOM	-		
	CARGO	1986-1991	NE-11P3	
TRANSCONTIN.	-	LF-6	LAS-R	
			LAS-V	
FORD (USA)	CARGO	1986-	NE-11P3	NE-11P3
	MODELOS	-1973	MAZ-14D	MAZ-14D
	MODELOS	1974-1984	MAZ-1D	MAZ-1D
			MAZ-1I	MAZ-1I
	MODELOS	1986-1987	NE-11	LF-WR
			NE-11P	
	MODELOS	1987-1988	FO-11D	FO-11D
		FO-20D	FO-20D	
MODELOS	1988-1995	NE-11	NE-11	
		NE-11P	NE-11P	
MODELOS	1996-1997	FO-15D	FO-15D	
		FO-15DP	FO-15DP	
FREIGHTLINER	VARIOS	-	BS-4D	BS-4D
			HUD-1	HUD-1
			YA-8D	YA-8D
GM (CHEVRO-LET)	MODELOS	1972-1980	TOYO-2	TOYO-2
	MODELOS	1981-1982	MIT-1I	MIT-1I
			MIT-1IP	MIT-1IP
			MIT-2I	MIT-2I
		MIT-2IP	MIT-2IP	
GM (GMC)	MEDIUM	1984-1986	DAT-6D	DAT-6D
	TRUCK W4	1984-1986	DAT-6DP1	DAT-6DP1
	MEDIUM	1986-	ISU-2	ISU-2
	TILTMAS-TER	1986-		
TRUCK W4	1986-			
HINO	MODELOS	1976-	TOYO-K1	TOYO-K1
			TOYO-K1P	TOYO-K1P
ISUZU	NKR	-	MIT-15P	MIT-15P
	NPR	-		
	NQR	-		
	TILTMAS-TER	1986-1988	DAT-6D	DAT-6D
	W4-W5 (S.N)	1986-1988	DAT-6DP1	DAT-6DP1
		ISU-1	ISU-1	
		ISU-2	ISU-2	
KENWORTH	MIDRANGER	1988-	NE-11	NE-11
			NE-11P	NE-11P
MACK	MIDLINER	1982-	BH-1	RO-4I
			BH-1P	
			DAV-1	
			DAV-1P	
	MODELOS	1955-1986	BS-1I	BS-1I
		YA-11D	YA-11D	
MAGIRUS DEUTZ	90 M 5.3	-	BH-1	RO-4D
	90 M 6.0	-	BH-1P	RO-4I
	90 M 6.6	-		



MARCA BRAND	MODELO MODEL			
MAGIRUS DEUTZ	90 M 7	-		
	90 M 9	-		
	130 M 11	-		
	130 M 13	-		
	130 M 16	-		
	130 M 9	-		
	160 M 13	-		
260	-	BH-2	PRE-1I	
360 D 18	-			
MAN	6.100 F	-	VO-R	VO-R
	6.90 F	-	VO-RP	VO-RP
	8.136 F	-		
	8.90 F	-		
	9.136	-		
	9.136 F	-		
	9.136 FAE	-		
	9.150 F	-		
	10.136	-		
	10.150 F	-		
	12.170	-	BH-1	HU-MN
	12.192 F-FT	-	BH-1P	HU-MNP
	12.192 FKT	-		
	12.232 FT	-		
	14.192 F	-		
	14.232 FKT	-		
	14.232 FT	-		
	17.232 F	-		
	18.272 FTI	-		
	19.240 F	-		
	19.262 F	-		
	19.321 F-F/2	-		
	19.322 F-FK	-		
	19.322 FLT	-		
	19.361 F-FT	-		
	19.361-T	-		
19.363 F	-			
19.372 FAK	-			
19.422 F-FT	-			
19.462 F	-			
19.502 F-FLT	-			
22.361	-			
24.362	-			
25.372 FNL	-			
25.422 FNL	-			
33.222 DF	-			
33.240	-			
33.281-T	-			
33.292	-			
33.362	-			
33.365	-			
33.372 DF	-			
33.372 DFA	-			
33.422 DF	-			
33.422 DFA	-			



MARCA BRAND	MODELO MODEL				
MAN	40.440	-			
	41.372 VFK	-			
	41.422 VFK	-			
	33.320	-	BH-1 BH-1P	HU-SX	
MERCEDES (ARGENTINA)	MODELOS	-	ME-9P	ME-9P	
	MODELOS	1990	ME-13DP ME-14P	ME-13DP ME-14P	
MITSUBISHI	FUSO	-1985	MIT-2I MIT-2IP	MIT-2I MIT-2IP	
	FUSO	1985-	MIT-10 MIT-11D MIT-9	MIT-10 MIT-11D MIT-9	
	L.35	-1993	DAT-6	DAT-6	
	M 115.17	-1993	DAT-6P	DAT-6P	
NISSAN	L.35.08	-1993	CHR-3 NE-22P	DAT-6 DAT-6P	
	L.70.09	-1993	CHR-5	DAT-6	
	L.80.14	-1993		DAT-6P	
	MODELOS	1980-	DAT-12 DAT-6 DAT-6P	DAT-12 DAT-6 DAT-6P	
	PEGASO	360	-	AU-1 AU-HV AU-HVP VO-HV VO-HVP	CHR-3 CHR-3P NE-22P1
		620	-	CHR-3 CHR-3P	VO-VB VO-VBP
1236		-	CHR-5	IMS-5 IMS-5P	
PIAGGIO		APE CAR	-	AF-9D	FAB-1
		APE CAR P3	-	AF-9DP	
		P 601	-	AF-9I AF-9IP FAB-1 FEM-1D FEM-1I	
		APE P 50	-	FEM-1D	
	APE TM P 50	-	FEM-1I NE-6 NE-6P		
	APE TM 703	-	AF-9D	FAB-1	
	NICA 125	-	AF-9DP AF-9I AF-9IP FAB-1		
	RENAULT SAVIEM	B 70.35	-1987	CHR-3	VA-7
		B 70.45	-1987	CHR-3P	
		B 90.35	-1987	LMP-5	
MASTER P35 D		-1987	LMP-5P1		
MASTER T30 D		-1987	NE-22P		
MASTER T35 D		-1987			
B 70.45		1988-1992	CHR-3	NE-28	

MARCA BRAND	MODELO MODEL			
RENAULT SAVIEM	B 80.45	1992-	NE-22P	
	B 90.45	1988-1992		
	B 90.50	1988-1992		
	B 110.150	1992-		
	B 110.35	1992-		
	MASTER T30 D	1987-		
	MASTER T35 D	1987-		
	MASTER TURBO	1987-		
	G 300 G	-1994	DAV-1	LAS-R
	G 330 GV	-1994	DAV-1P	LAS-V
	G 340 TI	-1994	NE-3	
	GR 305	-1994	NE-3P	
	GR 305 TURBO	-1994	NE-3P1	
	R 310	1984	NE-3P2	
	R 360	1984-1985		
	R 360 TURBO	1984		
	GB 119	1986	DAV-1	RO-4D
	GB 231 TURBO	1986	DAV-1P	RO-4I
	GC 231 TURBO	1986		
	GF 231 TURBO	1986		
	GR 231 TURBO	1986		
	JK 50-60	-	BH-1	RO-15
	JK 75-90	-	BH-1P	RO-4D
	JK 110-115	-		RO-4I
	JP 11	-	BH-1	RO-4D
	JP 13	-	BH-1P	RO-4I
	JP 13 TU	-		
JP 115	-			
M 160.12	-1994	NE-3	VA-10	
M 200.12	-1994	NE-3P		
M 230.12	-1994	NE-3P2		
M 230.13T	-1994			
M 230.16	-1994			
R 350 TI	-1992			
R 365	-1992			
R 380	-1992			
R 385	-1994			
R 420	-1992			
RI 357	-1992			
R 360	1985-1987	NE-3	LAS-R	
R 370	1985-1987	NE-3P	LAS-V	
R 370 T U8 T	1985-1987	NE-3P2		
S 100.06	-1994	NE-3	RO-4I	
S 100.07	-1994	NE-3P		
S 100.08 T.	-1994	NE-3P2		
S 150	-1994			
S 160.08 T	-1994			
S 160.09	-1994			
S 170.13	-1994			
S 170.145	-1994			
SG2/35-40	-	BH-1	LAS-R	
SG3/35-40	-	BH-1P	LAS-V	
SG4/35-40	-			
TRAFFIC	-1987	CHR-3	RO-17	

# CAMIÓN

## TRUCKS

MARCA BRAND	MODELO MODEL				
RENAULT SAVIEM			CHR-3P NE-22P		
	TRAFFIC	1988-	NE-19 NE-19P	NE-28	
ROVER	LEYLAND ROAD	-	NE-11 NE-11P	LAS-V	
SCANIA	110	-	BH-2	HU-SX	
	111	-	FO-FR		
	140 8V T	-	FO-FRP		
	141	-	WAS-2P		
	411 8V	-			
	112 H	-1987	VO-VB	WIT-1	
	142 H 8V	-1987	VO-VBP		
	P 82	-1987			
	P 92	-1987			
	P 93 H-HL	1988-			
	P 93 ML	1988-			
	P 113 EL	1988-			
	R 112 H	-1987			
	R 113 E-ES	1988-			
	R 113 HL-HS	1988-			
	R 113 M	1988-			
	R 113 MA	1988-			
	R 142 E	-1987			
	R 142 H	-1987			
	R 142 H 8V	-1987			
R 142 M	-1987				
R 143 EL-ES	1988-				
R 143 HL-HS	1988-				
R 143 MA	1988-				
R-144 NA	1996-	HU-2P	HU-2P		
STEYR PUCH	10 S 14	-	VO-VB	AKS-1	
	17 S 18	-	VO-VBP		
	19 S 31	-	NE-25		
	19 S 37	-			
	26 S 31	-			
	32 S 31	-			
TRUCK (USA)	MODELOS	1995	GM-14 GM-14P GM-25 GM-25P	GM-14 GM-14P GM-25 GM-25P	
	VOLKSWAGEN	MODELOS	1981-1984	VO-VB VO-VBP	VO-VB VO-VBP
		MODELOS	1984-	VO-HV VO-HVP VO-VB VO-VBP	VO-HV VO-HVP VO-VB VO-VBP
	VOLVO	F 6	-	NE-12	NE-12
F 7		-	NE-12P	NE-12P	
F 10		-			
F 12 T 6		-			
F 1020 T 6		-	NE-3 NE-3P NE-3P2	NE-12 NE-12P	

MARCA BRAND	MODELO MODEL			
VOLVO	FL 6 INTER.	-	NE-12	RO-4D
	FL 7 INTER.	-	NE-12P	RO-4I
	FL 10 INTER.	-		
	FL 12 INTER.	-		
	FL 611	-	NE-12	
	FL 614	-	NE-12P	
FL 616	-			
MODELOS	-1987	NE-1 NE-1P	NE-1 NE-1P	
WHITE	VARIOS	-1980	BS-4D HUD-1	BS-4D HUD-1
	VARIOS	-1989	BS-2 BS-5	BS-2 BS-5



**MOTOCICLETA**

MOTOZIKLETA  
MOTORCYCLE  
MOTOCYCLETTE  
MOTORRAD

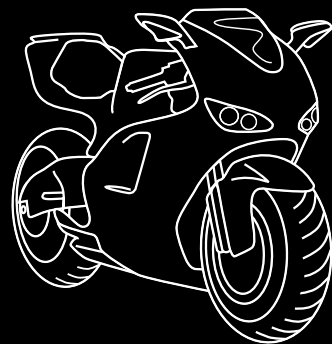







**THE KEY TO EXCELLENCE**  
GLOBALLY UNLOCKING MILLIONS OF DOORS DAILY









### MOTOCICLETA

MOTOZIKLETA • MOTORCYCLE • MOTOCYCLETTE • MOTORRAD

MARCA BRAND	MODELO MODEL			
APRILIA	AFI 50	1986-1991	ZA-1	ZA-1
	AFI 125	1986-1991	ZA-1P	ZA-1P
	AS 125 R.V.	1986-1991		
	ET 50	1986-1991		
	ETX 125 PV	1986-1991		
	ETX 350	1986-		
	ETX 600	1986-		
	EUROPA 125AE	1992-		
	EXTREMA 125	1993-		
	MX 125 A	1986-1991		
	PEGASO 125	1993-1994		
	RED ROSE 50	1986-1990		
	RED ROSE 125	1986-1990		
	RED ROSE 125	1993-1994		
	RX 125	1992-		
	TUAREG 125	1986-1991		
	AMICO	1996-1998	ZA-6DP1	ZA-6DP1
	AREA 51	1998-2000		
	CLASSIC 50	1996-1999		
	CLASSIC 125	1996-1999		
	ETV 1000 C.	2001-2007		
	GULLIVER	1995-1998		
	LEONARDO	1996-2004		
	MOJITO	1999-2008		
	MOTO 6.5	1996-2002		
	MX	2002-2006		
	PEGASO	1997-2004		
	PEGASO 3-650	1996-		
	RALLY	1996-2004		
	RS	1996-2005		
	RST FUTURA	2000-2003		
	RSV 1000	1998-2005		
	RX 50	1996-2004		
	SCARABEO	1993		
	SL 1000 F.	2000-2003		
	SONIC 50	1998-2008		
	SPORTCITY	2004		
	SR 125-150	1999-2001		
	SR 50	1996-2004		
	AMICO 50	1992-	ZA-4DP	ZA-4DP
	CLIMBER 280	1994-		
	EUROPA 50	1992-		
	EUROPA 125	1994-		
	FUTURA 50	1990-1991		
	FUTURA 50AE	1992-		
	PEGASO 50	1992-		
	PEGASO 125	1994-		
	PEGASO 600	1990-		
	PEGASO 650	1990-		

MARCA BRAND	MODELO MODEL			
APRILIA	RED ROSE 50	1992-		
	RED ROSE 125	1994-		
	RS 50 EXTRE.	1992-		
	RX 50	1992-1996		
	RX 125 EXT.	1994-		
	RX 125 REP.	1994-		
	SIX DAYS RX	1990-1991		
	SR 50	1992-1996		
	TUAREG R. 50	1994-		
	ATLANTIC 125	2003	ZA-9P1	ZA-9P1
	FILO GT 4L	-	AF-8D	
	MX 250	-	AF-8DP	
	RC 250	-	AF-8I	
			AF-8IP	
			FEM-2D	
			FEM-2I	
	FUTURA 50AE	1990-1991	ZA-13P	
	RX 50	1990-1991		
	FUTURA 125	1990-1991	ZA-2P	
	REPLICA 50	1990-1991		
	RALLY 125	1990-1991	ZA-1	NE-8
	RX 125	1990-1991	ZA-1P	
	RED ROSE 50	1990-1991	FI-11	ZA-1
			FI-11P	ZA-1P
			ZA-2P	
	TUAREG 125	1992-	ZA-2P	ZA-2P
	TUAREG 250	1986-	ZA-1	NE-8
	TUAREG 350	1986-	ZA-13P	
	TUAREG 600	1986-	ZA-1P	
ATALA	BYTE AT10-50	1996	ZA-4DP	ZA-4DP
	GREEN	1996		
	HAKER	1996		
BENELLI	124	-	FEM-1D	
	125 TURISMO	-	FEM-1I	
	125 SPORT	1982-1983		NE-8
	125 SPORT	1983-1984	FEM-2D	NE-6
	T 125	-	FEM-2I	NE-6P
	125 SPORT	1984-	FEM-2D	NE-8
	125 TURISMO	1984-	FEM-2I	
	250 2C	-		ZA-1
	304 4C	-		ZA-1P
	354	-		
	654	-		
	750 SEI	-		
	900 SEI	-		
	EXPORT 3V	-		
	G2	-		
	LASER	-		
	MAGNUM 3V	-		



MARCA BRAND	MODELO MODEL			
BENELLI	MOTORELLA 50	-		
	S 50	1985-		
	S 125	-		
BETA	50 CC	-1993	AF-5I	ZA-1 ZA-1P
	ALP	-	ZA-9P1	
	RR	2005		
	CHRONO	1995	ZA-4DP	
	CHRONO 502	1995		
	QUADRA	1995		
	TEMPO	1995		
	KR 50	-	FAB-1	FAB-1
	KR 125	-		
	KR 250	-		
	VRS 50	-		
	QUADRA	1996-	ZA-6DP1	ZA-6DP1
	TEMPO	1996-		
	BICICLETTA-CYCLES	MOD.DANES DK	-	
MOD.SUECO S		-		AS-21 AS-21D AS-2D AS-2I
RALEIGH		-		LF-2 UN-FP
BIMOTA	GPI 1	1990-	ZA-1 ZA-1P	ZA-1 ZA-1P
	HB 2	-	NE-6	NE-6
	HB 3	-	NE-6P	NE-6P
	HB 3/S	-		
	KB 1	-	SUZU-13P	NE-6
	KB 2/TT	-	SUZU-4I SUZU-4IP	NE-6P
	SB 2	-	SUZU-13P SUZU-4I SUZU-4IP	
	SB 3	-	SUZU-5	NE-6
	SB 4S	-	SUZU-5P	NE-6P
	SB 4SP	-		
BMA	AMICA 50	-	AF-9D	UN-MRN
	AMICA 125	-	AF-9DP	
	AMICA 250	-	AF-9I	
	AMICA 360	-	AF-9IP FEM-1D FEM-1I	
BMW	400 RS	1984-1985	NE-6 NE-6P	NE-6 NE-6P
	450	1984-1986	NE-7	NE-7
	650	1984-1986		
	K 1	1987-1993		
	K 75	1984-1992		
	K 75 RT	1993-		
	K 75 S	1993-		
	K 100	1984-1992		
	K 100 RS	1993-		



MARCA BRAND	MODELO MODEL			
BMW	K 1100 LT	1993-1994		
	K 1100 RS	1993-1994		
	R 45	1984-1986		
	R 65	1984-1992		
	R 80	1984-		
	R 80 GS	1993-		
	R 80 R	1993-		
	R 80 RT	1993-		
	R 100 GS	1993-		
	R 100 R	1993-		
	R 100 RS	1993-		
	R 100 RT	1993-		
	F 650	1994-	ZA-6DP	
	K 1100	1994-1995	BM-HBP1	BM-HBP1
	K 1100	1995		
	K 1100 LS	1994-		
	K 1100 LT	1994-		
	R 850 RT	1996-2002		
	R 1000	1995		
	R 1100	1994-1995		
	R 1100	1995		
	R 1100 GS	1994-		
	R 1100 R	1994-		
R 1100 RT	1994-			
R 60/6	-	NE-7	NE-6	
R 60/7	-		NE-6P	
R 75/6	-			
R 75/7	-			
R 80/7	-			
R 90 S	-			
R 90/6	-			
R 100 RS	-			
R 100/7	-			
R 100/S	-			
BUELL	BLAST	2000-2009	ZA-9P1	
	FIREBOLT	2002-2009		
	LIGHTNING	2003-2009		
	ULYSSES	2006-2009		
CAGIVA	125 ALETA	1986-		ZA-1
	200 ELEFANT	1984-		ZA-1P
	350 ALA	1984-1987		
	ALETA EL.125	-		
	COCIS 50	-1991		
	CRESTA 350	1984-1987		
	DG 350	1984-1987		
	RX 250	1984-		
	SST 250 ALA	1984-		
	SST 250 RL	1984-		
	SST 350 RL	1984-1987		
	SX 250	1984-		
	SX 350	1984-1987		
SXT 250	1984-			
WMX 250	1984-			
WMX 500	1984-			









# MOTOCICLETA

## MOTORCYCLE

MARCA BRAND	MODELO MODEL			
CAGIVA	650	-	SUZU-13P	SUZU-13P
			SUZU-4I	SUZU-4I
			SUZU-4IP	SUZU-4IP
	900 ELEFANT	1997	KAW-6P	
ALETA ORO L.	1986-		FI-6I	ZA-1
			FI-6IP2	ZA-1P
			FI-6IP3	
ALETA ROSA	1986-	SUZU-13P	ZA-1	
AR 350	1984-1989	SUZU-4I	ZA-1P	
ELEFA. 2 125	-	SUZU-4IP		
ELEFA. 2 200	-1984			
ELEFA. 2 350	1984-1989			
ELEFA. 2 600	-			
K 3	1991-1992			
SST 125	1984-			
SXT 125 N	1984-			
W 8	1994			
BLUES 125	-	FI-1	FI-1	
FRECCIA 125	-	FI-1P	FI-1P	
FULL FUN 125	-1990			
MITO 125	-1990			
MMX 125	-1990			
TAMANACO 125	-			
CITY	1993-1994	KAW-6P	KAW-6P	
ELEFA. 900	1992-			
MITO	1992-			
MITO 125	1991-1992			
MITO CARENA.	1991-1992			
MITO EV	1994-1995			
MITO LAWSON	1993-			
MITO RACING	1991-1994			
MITO RACING	1994			
PRIMA	1993-			
SUPER CITY	1993-			
CITY	1994-	ZA-8P	ZA-8P	
CITY LUCKY	1994-			
CITY PASSING	1994-			
SUPERCITY	1994-			
ELEFA. 90	-1991	FI-1	ZA-1	
ELEFA. 750	-1991	FI-1P	ZA-1P	
FRECCIA 125	1991-1992			
LUCKY 350 E.	1987-1991			
LUCKY 350 EX	-1991			
N 90	1991-1992			
PARIS DAKAR	-1991			
T 350 E	1987-1991			
T4 350	-1991			
T4 350 R	1987-1991			
T4 500 E	-1991			
HD 175	-	FEM-1D		
HD 350	-	FEM-1I		
RIVER 600 C.	1995-	ZA-4DP		
ROADSTER 125	1994	ZA-1		
		ZA-1P		



MARCA BRAND	MODELO MODEL			
CAGIVA	S.CITY 125	1992-	ZA-4DP	ZA-4DP
	SST-SX 125	-1984	FEM-1D	ZA-1
	SST-SX 250	-1984	FEM-1I	ZA-1P
	SST-SX 350	-1984		
	SXT 125	1984-	SUZU-13P	
			SUZU-4I	
			SUZU-4IP	
	TRIAL 125	-		CL-2I
	TRIAL 350	-		CL-3I
	W 12 350	1994	ZA-1	ZA-1
W 16	1997	ZA-1P	ZA-1P	
CIMATTI	GRINGO G1-4M	-		ZA-1
	GRINGO LUX	-		ZA-1P
DEMME	SMILY	-		NE-6
				NE-6P
DERBY	ATLANTIS 100	2003-	ZA-9P1	ZA-9P1
	MULHACEN	2006-		
	PREDATOR	1999		ZA-9P1
DKM-HERCULES	125 G SPEC.	-		NE-6
	175 GS	-		NE-6P
	250 GS	-		
	505 P	-		
	531	-		
	535 S	-		
DUCATI	125 REG. 2T	-		NE-6
				NE-6P
	250 SCRAMBL.	1982-	FEM-1D	NE-6
	350 GTV	1982-	FEM-1I	NE-6P
	350 SCRAMBL.	1982-	FEM-2D	
	450 SCRAMBL.	1982-	FEM-2I	
	500 2 CIL.	1982-		
	500 GTL	1982-		
	500 SL PANT.	1982-		
	750 GT-SS	1982-		
	750 SPORT	1982-		
	860 GT-GTS	1982-		
	900 2 CIL.	1982-		
	900 REPLICIA	1982-		
	900 SD-SS	1982-		
	350 F3 DESMO	1984-	FEM-1D	NE-8
	350 GTL-XL	1984-	FEM-1I	
	350 SL-TL	1984-	FEM-2D	
	500 GTV-SL	1984-	FEM-2I	
	500 SPORT D.	1984-		
600 SL-TL	1984-			
900 DARMAH	1984-			
350 SPORT	1993-	KAW-6P	KAW-6P	
400 SPORT	1993-			
600 S.SPORT	1994			
750 SS	1991-1992			
851 S	1991-1992			
851 SPORT	1991-1992			
888 RACING	1993-			
888 S.P.4	1991-1992			



MARCA BRAND	MODELO MODEL				
DUCATI	888 S.P.5	1993-			
	900 M	1993-			
	900 S.L.	1991-			
	900 S.S.	1991-1992			
	900 SS	1991-			
	907 i.e.	1991-1992			
	CARENATA	1991-			
	CUPOLINO	1991-			
	600 MONSTER	1994-2001	KAW-6P		
	748	1995-2003			
	750 S.SPORT	1999-2003			
	900 MONSTER	1994-2001			
	900 S.SPORT	1998-2002			
	996	1999-2004			
	ST 2	1997-2003			
	ST4	1998-2003			
	750 F1 DESMO	1986-1991	FEM-1D	NE-8	
			FEM-1I		
			FEM-2D		
			FEM-2I		
			FI-6I		
			FI-6IP3		
	750 F1 DESMO	1987	ZA-13P	ZA-13P	
	851 SPORT	1989-1990			
	907 i.e.	1989-1990			
	DESMO 900 SS	1989-			
	PASO 906	1989-			
	750 INDIANA	1990-1991	FI-6I	FI-6I	
	750 SPORT R	1990-1991	FI-6IP3	FI-6IP3	
	PASO 750 LTD	1990-1991			
	851 S	1990-1991	FI-6I	ZA-1	
	900 S.S.	1990-1991	FI-6IP3	ZA-1P	
907 i.e.	1992	ZA-4DP	ZA-4DP		
INDIANA 350	1987-		ZA-1		
INDIANA 650	1987-		ZA-1P		
INDIANA 750	1987-				
PASO 350	1987-	ZA-13P	ZA-1		
PASO 750	1987-		ZA-13P		
			ZA-1P		
FANTIC MOTOR	50.1 OASIS	1984-1991		ZA-1	
	CABALLERO	1992-		ZA-1P	
	CABALLERO 50	1984-1991			
	CLAN 50	1982-			
	CLUBMAN	1993-			
	ISSIMO	1982-			
	JOY 3V	1984-1991			
	JOY MK	1984-1991			
	JOY VK	1984-1991			
	KOALA	1993-			
	K-ROO	1992-			
	RAIDER 50.1	1984-1991			
	RAIDER 125LC	-			
	RAILLY 240	-			
	TENTER TO	1984-1991			



MARCA BRAND	MODELO MODEL				
FANTIC MOTOR	TRIAL 50	1982-			
	TRIAL 201	-1991			
	TRIAL 240	-1991			
	TRIAL 241	-1991			
	TRIAL 242	-1991			
	TRIAL 245	-1991			
	TRIAL 300	-1991			
	TRIAL 301	-1991			
	TRIAL 303	-1991			
	TRIAL 305	-1991			
	TRIAL KID	1984-1991			
	TRIAL S.5	1984-1991			
	TRIAL S.7	1984-1991			
	125	1984-	ZA-1	ZA-1	
	125 SPORT	1984-	ZA-1P	ZA-1P	
	ISSIMO 50	1984-			
	RAIDER 50	1984-			
	RAIDER GT 50	1984-			
	SPRINTER 3V	1984-			
	SPRINTER 50	1984-			
	SPRINTER MU.	1984-			
	STRADA 50	1984-			
	STRADA 125	1983-			
	ENDURO 50	1985-		NE-8	
	RAIDER 125	-			
	TRIAL 50	1985-			
	TRIALMATIC50	1985-			
	GR.TUR.50 CC	-		NE-6	
				NE-6P	
	HP1 125	-	FI-6I	FI-6I	
			FI-6IP3	FI-6IP3	
	LEI 50 CC	-		IMS-5	
			IMS-5P		
TRIAL 125	-		NE-8		
TRIAL 200	-		ZA-1		
			ZA-1P		
GARELLI	BASIC 50	1985-		ZA-1	
	BASIC2 50	1985-		ZA-1P	
	FORMUNO	1988-1991			
	GARY	1992-			
	GARY DUE 50	1988-1991			
	GARY UNO 50	1988-1991			
	SAHEL 50 ES	-1991			
	TEAM 3V 50	-1991			
	TEAM BIMATIC	-1991			
	TEAM MATIC	-1991			
	URKA AC-LC50	-1991			
	VIP N3V 50	-1991			
	CICLONE 50	-1986		AF-19	
	CICLONE 5V 5	-1986		AF-19P	
	EUREKA FLEX	-		IMS-5	
	JUNIOR T 50	1982-1986		IMS-5P	
	JUNIOR GT 50	1982-1986		ZA-1	
	JUNIOR K1005	-1986		ZA-1P	



# MOTOCICLETA

## MOTORCYCLE

MARCA BRAND	MODELO MODEL			
GARELLI	NOI 50	-1986		
	VIP 1-N50	-		
	VIP 2-N50	-		
	VIP 3-N50	-		
	VIP 4-N50	-		
	CICLONE 5VN	1986-1988	ZA-1	ZA-1
	CICLONE LC	1986-1988	ZA-1P	ZA-1P
	NOI BIMATIC	1987-1991		
	NOI MATIC	1987-1991		
	NOI TL 50	1987-1991		
	GRAN TURISMO	-		NE-6 NE-6P
	GTA 125	-	FI-6I FI-6IP3	FI-6I FI-6IP3
	SUPER VIP	1985-1989	AF-6D	ZA-1
	TIGER 125XLE	-		ZA-1P
	TRS 125 S.M.	-		
	XR 125 TIGER	-		
TIGER XRD	-	ZA-1 ZA-1P		
GILERA	50 GSA LUS	-	AF-6D	NE-8
	50 TS-GSA	-		
	50 R1	-		ZA-2P
	50 RALLY	-		
	50 RC TRO.	-		
	50 TREND	-		
	50 SIOUX A	-	ZA-4DP	ZA-4DP
	125 APACHE	1991-		
	125 CROMO	1991-		
	125 FREE ST	-		
	125 GFR S.P.	-		
	125 SIOUX	-		
	350 NORDWES	1993-		
	600 NORD WE	-		
	600 R	1993-		
	600 RC	1991-		
	RC 750 R	-		
	TYPHOON	-1995		
	125 CX AE	-	ZA-1	ZA-1
	125 GRF	1993-	ZA-1P	ZA-1P
	125 R	1993-		
	503 AE	1993-		
	ARIZONA 125	-		
	ARIZONA 250	-		
	BULLIT AE	1992		
	BULLIT KICK	1992		
	BULLIT MIX	1993-		
	RC 600 R	1991-		
	RTX 125-200	-		
	RV 125-200	-		
	RX 125-200	-		
	SIOUX AE	1993-		
125 GR1-TG1	-		NE-6	
150	-		NE-6P	



MARCA BRAND	MODELO MODEL			
GILERA	ECO 50	-		
	125 MRX	-1991	FI-1	FI-1
	125 RC	-1991	FI-1P	FI-1P
	125 SPO1	-1991		
	125 SPO2	-1991		
	125 XR2 R.	-1991		
	125 TG2	-	AF-6D	ZA-1 ZA-1P
	200 T 4	-	AF-9D	
	200 T45	-	AF-9DP	
	CUSTOM 125	-	AF-9I	
	CUSTOM 200	-	AF-9IP	FEM-1D FEM-1I
	250 NGR	-	FI-6I FI-6IP3	FI-6I FI-6IP3
	350 DAKOTA	-1990	FI-6I	FI-6I
	500 DAKOTA	-1990	FI-6IP3	FI-6IP3
	500 SATURNO	-1990	ZA-2P	ZA-2P
	600 RC	-1990		
	CBA 50	-1991		ZA-1 ZA-1P
	NCR 50	2006-	ZA-9P1	ZA-9P1
	NEXUS	2006-		
	RUNNER	2006-		
	STORM 50	1995	ZA-7DP	
	TYPHOON	1995-		
HARLEY DAVIDSON	883 SPORT.	1994	HD-4D	HD-4D
	1200 SPORT.	1994		
	FLH 1340 EL	-	HD-1	NE-6
	FLHC 1340 EL	-	HD-1D	NE-6P
	FLHC 1340 S.	-	HD-2	NE-8
	FLT 1340 TO.	-	HD-2D	
	FLTC 1340 TO	-	HD-3	
	FXB 1340 ST.	-	HD-3D	
	FXE 1340 SU.	-		
	FXPS 1340 SU	-		
	FXR 1340 SU.	-		
	FXS 1340 LOW	-		
FXWG 1340 WI	-			
XLH 1000 SP	-			
XLS 1000 RO	-			
VARIOS	-1960	BS-6		
VARIOS	1996	CHI-1T	CHI-1T	
HERCULES	K 125	-	YAMA-21I	YAMA-21IP
HM	LOCUSTA	-	ZA-9P1	
HONDA	125	1980-	SUZU-13P	NE-6
	125 E	1980-1982	SUZU-4I	NE-6P
	125 S	1980-	SUZU-4IP	
	125 SILHO.	1980-		
	CB 125 T2	1982-		



MARCA BRAND	MODELO MODEL				
HONDA	125 E	1982-	SUZU-13P SUZU-4I SUZU-4IP	NE-8	
	125 LEAD	1991	HOND-4I	HOND-4I	
	600 VT.R.	1990-	HOND-4IP1	HOND-4IP1	
	CBR 600 F	1987-			
	CBR 1000	1991-1992			
	VF 750 C	1990-			
	VFR 750 FK	1990-1991			
	VFR 750 FL	1990-1991			
	VFR 750 P.	1990-1991			
	VFR 750 R	1990-1991			
	XRV 750 A.	1992-			
	125 VISION	-	SUZU-13DP SUZU-4D SUZU-4DP	SUZU-13DP SUZU-4D SUZU-4DP	
	200 R	-1989	HOND-19	HOND-19	
	CB 650	1984-	HOND-19D	HOND-19D	
	CB 750	1986-1991	HOND-19DP	HOND-19DP	
	CB 900	1984-	HOND-19P	HOND-19P	
	CB 1100	-1993	HOND-4D	HOND-4D	
	CBX 500	1984-1987	HOND-4DP	HOND-4DP	
	CBX 550	1984	HOND-4DP2	HOND-4DP2	
	CBX 650	1984-	HOND-4I	HOND-4I	
	CBX 750	1986-1991	HOND-4IP	HOND-4IP	
	CR 500	1984-1987			
	CX 650	1984-			
	FT 500	1984-1987			
	GL 650	1984-			
	GL 1100	-1991			
	NS 400	1986-			
	VF 500	1984-1987			
	VF 750	1986-1991			
	VF 1000	-1991			
	VF 1100	-1991			
	VRF 750	1986-1991			
	VT 500	1984-1987			
	XLV 750	1986-1991			
	YT 1100	-1991			
	350 FOUR	1979-1981	HOND-7I	NE-6	
	500 FOUR	1979-		NE-6P	
	350 FOUR	1981-	HOND-4D	NE-6	
	400 FOUR	1981-1982	HOND-4DP	NE-6P	
	CB 400 N	1979-1981	HOND-4DP2		
	CB 400 N	1981-1982			
	CB 750 K	1980-			
CM 400 T	1981-1982				
CX 500	1981-1982				
400 CBF	1979-	HOND-3I	NE-6		
500 CBT	-		NE-6P		
500 FOUR	1976-1979	HOND-49	NE-6 NE-6P		
500 FOUR K	1979-	HOND-4D			
1100 GOLD W.	-	HOND-4DP			



MARCA BRAND	MODELO MODEL			
HONDA	CB 650	-	HOND-4DP2	
	CB 750 F.	1980-		
	CB 750 FI	1981-		
	CX 500	1979-1981		
	500 R	1983-	VO-VBP1	VO-VBP1
	600 R	1983-		
	1200 G.W.	-1991		
	GL 1200	-1991		
	GL 1500	-1991		
	GX 1200 DL	-1991		
	VF 750 C	1982-1990		
	VF 750 CU.	1982-		
	VF 750 S	1982-		
	XL 350 R	1986-1991		
	XL 350 RF	1986-1991		
	500 R CROSS	1982-	HOND-4D	NE-8
	CB 250 N	1986-	HOND-4DP	
	CB 250 RS	1986-	HOND-4DP2	
	CB 750 C	1979-		
	CB 750 K	1979-1980		
	CB 900 B.	1982-		
	CB 900 F	1982-		
	CB 900 FI	1982-		
	CB 1100 R	-		
	CBR 250 F	1986-		
	CBX 400 F	1982-		
	CBX 400 FC	1984-		
	CBX 400 FI	1984-		
	CDI 125 6	1984-1986		
	FT 500	1983-1984		
	RAVEL 250	1986-		
	REBEL 250	1986-		
	XL 500 R	1982-1984		
	XL 500 S	1982-		
	XR 500 R	1982-1984		
	600 PROA.	1985-1991	HOND-4D	HOND-4D
	600 VTR.	1985-1991	HOND-4DP	HOND-4DP
	CB 450	1986-	HOND-4DP2	HOND-4DP2
	CBX 1000 S.S	-	HOND-4I	HOND-4I
	CX 500	1984	HOND-4IP	HOND-4IP
	MTX 200 R	-1989		
	NTV 650	1984-1992		
ST 1100	-1991			
TRX 200 SX	-1989			
VF 400 F	1986-			
VFR 400 R	1986-			
XL 200	-1989			
XL 200 PD	-1989			
XL 500 R	1984-			
XL 600	-1984			
XL 600	1985-1991			
XL 600 LM	1985-1991			
XL 600 R	1985-1991			
XL 600 RM	1985-1991			



# MOTOCICLETA

## MOTORCYCLE

MARCA BRAND	MODELO MODEL			
HONDA	XL 600 RX	1985-1991		
	XR 500 R	1984-		
	600 V.T.	1992-	HOND-4D	HOND-4D
	CB 750	1992-	HOND-4DP1	HOND-4DP1
	NTV 650	1992-1996	HOND-4DP2	HOND-4DP2
	NX 650 D	1983-		
	VFR 750	1986-1989		
	VT 600	1989-		
	650 G.W.	1983-1991	HOND-4D	HOND-4D
	ASPENCADE	-1991	HOND-4DP	HOND-4DP
	CB 250 N	1982-1985	HOND-4DP2	HOND-4DP2
	CB 250 RS	1982-1985		
	CB 400 L	1985-		
	CB 400 N	1982-		
	CB 550	1982-		
	CBR 1000	-1991		
	CBX 125	1984-	HOND-4DP1	HOND-4DP1
	CBX 1100 6C.	-	HOND-4DP2	HOND-4DP2
	CL 250 N	1982-1985	HOND-4D	
	CL 250 S	1982-1985	HOND-4DP	
	CM 250 C	1982-1985	HOND-4DP2	
	CX 500	1982-1984	HOND-4I	
	ENTERSTAT	-1991	HOND-4IP	
	G.WING 1.2	-1991	HOND-4I	HOND-4I
	GL 500	1982-	HOND-4IP	HOND-4IP
	ST 1100 PE	1991-		
	VT 500	1983-1984		
	X 400 R	1986-		
	XL 125 P.D	1984-1986		
	XL 125 P3	1990-		
	XL 125 PD	1984-1986		
	XL 125 R	1984-1986		
	XL 125 R3	1990-		
	XL 125 SD	1984-1986		
	XL 200 P3	1989-1991		
	XL 200 PD	1989-1991		
	XL 200 R	1989-1991		
	XL 200 R2	1989-1991		
	750 AFRICA	1991	HOND-19	HOND-19
			HOND-19D	HOND-19D
			HOND-19DP	HOND-19DP
			HOND-19P	HOND-19P
			HOND-4D	HOND-4D
			HOND-4DP1	HOND-4DP1
			HOND-4DP2	HOND-4DP2
750 FOUR	1979-	HOND-4D		
		HOND-4DP		
		HOND-4DP2		
		HOND-4I		
		HOND-4IP		
750 RXLV	1985-	HOND-4I	HOND-4I	
750 XLV	1985-	HOND-4IP	HOND-4IP	
CB 125 T	1986-			
CN 250	-1991			



MARCA BRAND	MODELO MODEL			
HONDA	MTX 125 R	1986-		
	NX 125	1990-		
	NXR 650 A.	1988-1990		
	PC 800	1989-1991		
	SPACY SCOOT.	-		
	XL 250 R	-1991		
	BIG RED 125	1986-	HOND-19	HOND-19
	CB 450	1986	HOND-19D	HOND-19D
	CBR 1000	1992	HOND-19DP	HOND-19DP
	CN 250	1991-1994	HOND-19P	HOND-19P
	CRM 125	1990-1992	HOND-4I	NE-6
	CX 500	1984-1987	HOND-4IP	NE-6P
	MTX 200	-1989		NE-8
	NH 125 PEAD	1986-	HOND-4I	NE-6
	NTV 650	1984-1994	HOND-4IP	NE-6P
	NX 650	1991-1994		
	PK 50 DX WA.	1992	HOND-4D	HOND-4D
	SA 50 M VIS.	1992	HOND-4DP1	HOND-4DP1
	SPACY	-	HOND-4DP2	HOND-4DP2
	ST 1100	1992	HOND-4I	HOND-4I
	TRX 200	-1989	HOND-4IP1	HOND-4IP1
	VF 400	1986		
	VFR 400	1986		
	VFR 750	1991		
	XL 125	1984-1986	HOND-24P	HOND-24P
	XL 125	1990-		
	XL 200	1990-1991		
	XL 250	-1991		
	XL 500	1984-		
	XL 600	1984-1985		
	XR 500	1984-		
	CAMINO S 50	-		NE-8
	CBX 900 FII	-		
	CB 125 S	1979-	HOND-4D	NE-6
			HOND-4DP	NE-6P
			HOND-4DP2	
			HOND-4I	
			HOND-4IP	
	CB 125 SI.	1982-	HOND-4I	NE-6
	XL 125	1982-1983	HOND-4IP	NE-6P
				NE-8
	CB 125 X	1982-	HOND-4I	NE-6
	CBX 125	1982-1983	HOND-4IP	NE-6P
	CS 125	1982-		
	CB 500	1994-1997	HOND-4D	HOND-4D
CB 1000	1993-	HOND-4DP1	HOND-4DP1	
CBR 900 RR	1994-1996	HOND-4DP2	HOND-4DP2	
CBR 1000	1992-	HOND-4I	HOND-4I	
CRM 125	1990	HOND-4IP1	HOND-4IP1	
NSR 125 F	1990-			
NSR 125 R	1990-			
NSR 125 R SP	1990-			
CB 500S	1997-	HOND-24P	HOND-24P	
CBF 500	2004-			



MARCA BRAND	MODELO MODEL				
HONDA	CBF 600	2004-			
	CBR 900 RR	1997			
	CBR 1000 F	1997			
	FORZA	2005-			
	NTV 650	1997-1998			
	NX 650	1997-			
	SFX 50	1997-			
	SH 50	1997-			
	SH 100	1997-			
	SJ 100 BALI	1997-			
	ST 1100	1997-			
	CB 550 F	1979-1982		NE-6	NE-6P
	CB 650 CUST	-	HOND-4D	NE-8	
	CB 650 SC	-	HOND-4DP1		
			HOND-4DP2		
	CB 750 F	1979-	HOND-7D	NE-6	
			HOND-7I	NE-6P	
	CB 750 FO.	1978-	HOND-7I		
	CBX 125	1983-1984	SUZU-13P	NE-6	
	MH 125	1983-	SUZU-4I	NE-6P	
	XL 125	1983-1984	SUZU-4IP	NE-8	
	CBX 900	1984-	HOND-19		
			HOND-19D		
			HOND-19DP		
			HOND-19P		
	CG 125	1993-2008	HOND-26DP1	HOND-26DP1	
	ECONO POW.90	1993-	HOND-26P1	HOND-26P1	
	CMX 450 SC.	-1991	SUZU-13P	SUZU-13P	
			SUZU-4I	SUZU-4I	
			SUZU-4IP	SUZU-4IP	
	CR 250	-1991	HOND-19	HOND-19	
			HOND-19D	HOND-19D	
		HOND-19DP	HOND-19DP		
		HOND-19P	HOND-19P		
		HOND-4I	HOND-4I		
		HOND-4IP	HOND-4IP		
DYLAN 125	2004-	ZA-9P1	ZA-9P1		
PHANTEON 150	2003-				
PS 125I	2006-				
PS 150I	2006-				
SH 125I	2005-				
SH 150I	2006-				
HORNET	1998	HOND-43	HOND-43		
		HOND-43D	HOND-43D		
		HOND-43DP	HOND-43DP		
		HOND-43P	HOND-43P		
LEAD 100	2003-	HOND-28P			
MTX 125	1990-1992	HOND-19	HOND-19		
MX 125	1990-1992	HOND-19D	HOND-19D		
		HOND-19DP	HOND-19DP		
		HOND-19P	HOND-19P		
		HOND-4D	HOND-4D		
		HOND-4DP1	HOND-4DP1		

MARCA BRAND	MODELO MODEL			
HONDA			HOND-4DP2	HOND-4DP2
			HOND-4I	HOND-4I
			HOND-4IP1	HOND-4IP1
	NH 50	-1991	AF-6D	NE-8
	PA 50 DLX	-1991		
	PK 50 DX	-1991		
	PX 50 S	-1991		
	SA 50	-1991		
	PK 50	1993-	HOND-25P2	HOND-25P2
	SA 50 P	1993-	HOND-4I	HOND-4I
	SH 50	1993-1996	HOND-4IP1	HOND-4IP1
	SFX 50	1994-1995	HOND-20	
	SJ 50 BALI	1994-1995	HOND-20D	
			HOND-20DP	
			HOND-20P	
	SH 50	1991-1993	VO-VBP1	HOND-30DP2
				HOND-30P2
				VO-VBP1
	VFR 750	1989-1991	HOND-20	HOND-20
			HOND-20D	HOND-20D
		HOND-20DP	HOND-20DP	
		HOND-20P	HOND-20P	
VRF 750	1989-1991	HOND-28DP	HOND-28DP	
		HOND-28P	HOND-28P	
ITALJET	ASCOT	1992-	YAMA-27	YAMA-27
	BAZOOKA	1992-	YAMA-27D	YAMA-27D
	TIFFANY	1992-	YAMA-27DP	YAMA-27DP
			YAMA-27P	YAMA-27P
	DRAGSTER	1998	ZA-9P	ZA-9P
	FORMULA 50	1996-	ZA-4DP	
	PISTA	1994	YAMA-27DP	YAMA-27DP
	SCOOP	1994	YAMA-27P	YAMA-27P
KAWASAKI	400 CUSTOM	1991-	KAW-6P	KAW-6P
	750 CUSTOM	1991-		
	EN 500	1993-		
	KLX 650	-		
	TWIN CAM	1992		
	VN 1500 SUMO	-		
	VN 1600	2003-		
	ZXR 400	1991-		
	ZXR 1100	1991-		
	ZZR 250	-		
	ZZR 600	-		
	ZZR 1100	1991-1992		
	400 GT	1980-1985	KAW-8	KAW-8
	400 KZ	1980-1985		
	400 Z	1980-1985		
	400 ZB	1980-1985		
	550 LTD	1982-	KAW-3	KAW-3
	GPZ 250	-		
	GPZ 305	-		
	GPZ 450	-		
	GPZ 550	1982-1984		
	GPZ 600 R	-		



# MOTOCICLETA



## MOTORCYCLE

MARCA BRAND	MODELO MODEL			
KAWASAKI	GPZ 750	-		
	GPZ 750 R	-		
	GPZ 900 R	-		
	GPZ 1000	-		
	GPZ 1100	-		
	GPZ 1300	-		
	KL 250	-		
	KLR 250	-		
	VOYAGER	-		
	Z 250 C	-		
	Z 250 GP	-		
	Z 250 LTD	-		
	Z 305	-		
	Z 450	-		
	Z 550	1982-1984		
	Z 600	-		
	Z 750	-		
	Z 750 LTD	-		
	Z 750 TURBO	-		
	Z 900	-		
	Z 1000	-		
	Z 1100	-		
	Z 1300	-		
	900 Z1	-	KAW-4	KAW-4
	1000 GTR	1984-1991	KAW-3	KAW-5
	1300 Z	1986-1991	KAW-5	KAW-5P
	CS 250	1984-1986	KAW-5P	
	FX 400 R	1984-		
	GPZ 305	1984-		
	GPZ 550	1984-1990		
	GPZ 750	1984-1991		
	GPZ 900 R	-1986		
	GPZ 1000	1984-1991		
	GPZ 1100	1984-		
	GT 750	1984-1991		
	GTR 1000	1984-1991		
	KL 250	1984-1986		
	KLR 570	1984-1990		
	KLR 650	1980-1991		
	LTD 450	1984-		
	SR 650	1980-1991		
	TENGAJ 650	1980-1991	KAW-5	KAW-5
	VN 750 T.	1984-1991	KAW-5P	KAW-5P
	Z 250	1984-		
	Z 305 B.	1984-		
	Z 400	1984-		
	Z 440	1984-		
	Z 550	1984-1990		
	Z 750	1985-1992		
	Z 1000 RZ	1984-1991		
Z 1100	1984-			
Z 1300	1986-1991			
ZN 1300 V	1986-1991			
ZR 550	1984-1990			

MARCA BRAND	MODELO MODEL			
KAWASAKI	ZX 550	1984-1990		
	ZX 1000	1984-1991		
	ZXR 750	1985-1992		
	AR 125	-1986		NE-6
	KDX 175	-		NE-6P
	KE 125	-1986		
	KE 175	-		
	KMX 125	-1986		
	KX 125	-1986		
	EJ 650	1999-2006		
	EJ 800	2011		
	KLR 250	1997-2010		
	KLX 125	2010-2011		
	KLX 250	1999		
	NINJA 250R	1990-2007		
	NINJA 500R	1993-1994		
	NINJA 600R	1990-1996		
	NINJA ZX- 6R	1993-2006		
	NINJA ZX-11R	1993-2001		
	VN 250	2000		
	VN 400	1999-2000		
	VN 1500	1987-2001		
	VN 1700	2009		
	VN 2000	2004-2010		
	Z 500	1991-1998		
	Z 750	1992-1997		
	Z 1000	2003-2005		
	ZG 1000 CON.	1992-2006		
	ZRX 1100	1992-2000		
	ZRX 1100	2001-2006		
	ZRX 1200	2001-2006		
	EN 500	-1991	KAW-2I	KAW-2I
	KLR 250	1985-1986		
	ER 5	2003-	KAW-9P	KAW-9P
	NINJA ZX- 6R	2003-		
	NINJA ZX- 7R	2003-		
	NINJA ZX- 9R	2003-		
	NINJA ZX-12R	2003-		
	Z 750	2004-		
	ZR 7	1999-		
ZZR 1200	2003-			
GLX 1100	1993-	KAW-5	KAW-5	
GPX 600	1986-1990	KAW-5P	KAW-5P	
GPZ 500	1987-			
GPZ 500 S	1994			
GPZ 600	1986-1990			
KDX 250 D	-			
KL 250	1986-			
KLE 500	1994			
KLR 250	1986-1996			
KX 250	1986-			
LTD 450 C.	1986-			
SJ 50 BALI	1994			
Z 650	1983			





MARCA BRAND	MODELO MODEL			
KAWASAKI	ZL 600	1990-1992		
	ZZR 600	1990-1992		
	GPZ 400	-	KAW-3	KAW-3
	GPZ 550	-	KAW-4	KAW-4
	LTD 450	-	SUZU-13P	
	Z 400	-	SUZU-4I	
	Z 400 TW.	-	SUZU-4IP	
	Z 440 LTD	-		
	Z 550 LTD	-		
	GPZ 750	-1984	KAW-3	
	Z 400 F	1981-1982		
	Z 400 J	1981-1982		
	Z 500	1981-1991		
	Z 750	1984-1985		
	KH 400	1978-	KAW-4	
	OH 400	1978-	SUZU-13DP	
	Z 400	1978-1981	SUZU-13P	
			SUZU-4D	
			SUZU-4DP	
			SUZU-4I	
			SUZU-4IP	
	KL 600 S	1986-1991	KAW-2D	KAW-2D
	KLR 600	1986-1991	KAW-2I	KAW-2I
	KLR 600	-	KAW-1D	KAW-1D
	Z 440	-	KAW-1I	KAW-1I
	Z 650 F	1984-1991		
	Z 650 S	1984-1991		
	Z 650 SR	1984-1991		
	KLR 600 S	1994-1995	KAW-7P	KAW-7P
	KLR 650	1994-1995		
	NINJA ZX- 9R	1994-1995		
	ZXR 750	1993-1994		
	ZZR 600	1994-1995		
	ZZR 1100	1993-1994		
	KL 1000	2004-	SUZU-12DP	SUZU-12DP
	LDT 500	1995	KAW-6DP	KAW-6DP
	VN 800	1995		
	NINJA 250R	2011	KAW-10P	KAW-10P
	Z 250 A	1982-	KAW-2I	
	Z 250 C	1982-	KAW-8	
Z 250 J	1982-	KAW-8D		
Z 400	1978-1980	KAW-8		
Z 400	1981			
Z 400	1981-1984	KAW-2I		
Z 440 H	1982-	KAW-2D		
Z 440 J	1982-	KAW-2I		
Z 440 LTD	1982-			
ZL 600 ELI.	1997	KAW-5		
		KAW-5P		
ZXR 400	1990-1991	KAW-2D	KAW-2D	
ZXR 1100	1990-1991			
ZZR 1100	1990-1991			
KTM	ER 5	2003-	ZA-9P1	ZA-9P1
	MODELOS	1988-	VO-VBP1	VO-VBP1



MARCA BRAND	MODELO MODEL				
KYMCO	GRANDINK	2001			
	CX 50	1997	HOND-4I	HOND-4I	
	K 1250	1997	HOND-4IP	HOND-4IP	
	KB 50	1997			
	SNIPER 50 DD	1997			
	HEROISM	1997-	KYM-1DP	KYM-1DP	
			KYM-1P	KYM-1P	
	LAMBRETTA	LUI 50	-		IMS-3
					IMS-3P
					NE-56
LAVERDA	50 ATLAS	1986-1990	ZA-1	ZA-1	
	50 GAUCHO	1986-	ZA-1P	ZA-1P	
	125 CU RIDE	1986-1990			
	125 FORMULA	1986-1990			
	125 GS LES.	1984-			
	125 L ELEG.	1984-			
	125 LB CUS.	1984-			
	125 LB SAB.	1984-			
	125 LB UNO	1984-			
	125 LESMO G	1986-1990			
	125 LZ CUS.	1984-			
	350 LESMO	1984-			
	600 ATLAS O	-			
	1000 SFC	1986-			
	V6 1000 R	-			
	50 LZ	-	NE-8	NE-8	
	125 LZ	1978-	NE-6	NE-6	
	125 LZ C.	1978-	NE-6P	NE-6P	
	125 LZ S.	1978-	NE-8		
	500 4T	-	SUZU-13P	NE-6	
	500 SFC	-	SUZU-4I	NE-6P	
	750	1978-	SUZU-4IP		
	1000	1978-			
1000 JOTA	-				
1000 JOTA 120	-				
1000 RGS	-				
1200	1978-				
1200 TS	1978-				
PHOENIX	2003-	ZA-8P	ZA-8P		
LINCE	125 SERVETTE	-		CL-2I	
	150 SERVETTE	-		CL-3I	
	200 SERVETTE	-			
MAICO	GM STAR 250E	-		CL-2I	
	GM STAR 500E	-		CL-3I	
	GM STAR SID.	-		NE-6	
				NE-6P	
			NE-8		
MALAGUTI	50 MDX	1986-1991	ZA-1	ZA-1	
	50 MEX	1986-1991	ZA-1P	ZA-1P	
	50 MFX	1986-1991			
	50 MGX	1986-1991			
	CUSTOM	1986-1991			
	FIFTY FULL	1986-			
	FIFTY HF 50	1986-1991			









# MOTOCICLETA

## MOTORCYCLE

MARCA BRAND	MODELO MODEL			
MALAGUTI	FIFTY TOP 50	1986-		
	RUNNER YLC	1986-1991		
	TOP 50	1986-1991		
	125	1986-		ZA-1
	125 RUNNER	1986-		ZA-1P
	CAVALCONE 80	-		
	CHOPPER 25	-		
	CHOPPER 40	-		
	CHOPPER 80	-		
	DRIBBLING	1986-		
	DROP	-		
	DUNE ES	1986-		
	DUNE KS	1986-		
	FIFTY	-		
	FIRE BIRD	-		
	GRIZLY UNO	-		
	MRX ENDURO	1986-		
	NEW DRIBLING	-		
	PULL CX	-		
	CENTRO SL	1994	ZA-4DP	ZA-4DP
	CROSSER 50	1994-		
	F 10	1994		
	PHANTOM	1994		
	RS	1991		
	F 10 JET	1992-	YAMA-27	YAMA-27
			YAMA-27D	YAMA-27D
		YAMA-27DP	YAMA-27DP	
		YAMA-27P	YAMA-27P	
		YAMA-30P	YAMA-30P	
FIREFOX F15	1996-1997	ZA-9P	ZA-9P	
MADISON	2003-			
RST 50	1991-1992	ZA-13P	ZA-4DP	
		ZA-4DP		
MALANCA	125 MARKT	-	ZA-1	ZA-1
			ZA-1P	ZA-1P
	BIG	-		ZA-1
	GTS 4 4M	-		ZA-1P
	GTS 5	-		
	LP	-		
	LPRL	-		
MBK	BOOSTER	1995-1997	ZA-4DP	ZA-4DP
	EVOLIS	1995-		
	FORTE	1995-		
	NEW SORRISO	1995-		
	BOOSTER	1998	ZA-9P1	ZA-9P1
	KILIBRE	2003-		
	OVETTO	1998		
	BOOSTER 50	-	YAMA-27	YAMA-27
	EVOLIS	-	YAMA-27D	YAMA-27D
	SCOOTER	-	YAMA-27DP	YAMA-27DP
	SORRISO	-	YAMA-27P	YAMA-27P
	TARGET	-	ZA-4DP	ZA-4DP
	MBM	BREEZE LUSSO	-	
BULL		-		ZA-1P



MARCA BRAND	MODELO MODEL			
MBM	CRAZY	-		
	PONY	-		
	SOGNO	-		
MONTESA	250 ENDURO	-1991		CL-2I
	250 KING SC.	-1991		CL-3I
	348 TRIAL	-1991		
	360 ENDURO	-1991		
	CAPPRA 250	-1991		
	COTA 50	-1991		
	COTA 50 AR.	-1994		
	COTA 50 H20	-1994		
	COTA 123 C	-1991		
	COTA 125	-1991		
	COTA 200	-1991		
	COTA 242 T	-1991		
	COTA 247	-1991		
	COTA 250	-1991		
	COTA 304	-1991		
	COTA 307	-1991		
	COTA 330	-1991		
COTA 335	-1991			
COTA 348	-1991			
COTA 349	-1991			
COTA 350	-1991			
MORINI FRANCO	GIULIETTA O.	-		ZA-1
	LEM	-		ZA-1P
MOTO GUZZI	65 GT	1984-	IMS-5	NE-6
	650 NTX	1984-	IMS-5P	NE-6P
	850 LE MANS	1981-		NE-8
	850 T3 C.	1981-		
	850 T3-T4	1981-		
	V 35	1982-1984		
	V 35 II	1982-1984		
	V 35 IMOLA	1982-1984		
	V 50	1990-		
	V 50 C	1982-1984		
	V 50 C	1984-		
	V 50 CH.	1982-		
	V 50 III	1982-1990		
	V 50 III	1990-		
	V 50 MONZA	1982-1984		
	V 50 MONZA	1984-		
	V 50 TS	1982-		
V 65	-			
V 65	1984-			
V 65 C	1984-			
V 65 FL.	1984-			
V 65 II	1984-			
V 65 LA.	1984-			
V 65 SP	1984-			
V 65 TT	1984-			
V 75	-			
V 75	1984-			
125 BX	1986-		NE-8	



MARCA BRAND	MODELO MODEL			
MOTO GUZZI	125 CUSTOM	1986-		
	125 TT	1986-		
	125 TURISMO	-		NE-6
	850 T3	1986-		NE-6P
	DINGO	-		
	STORNELLO	-		
	125 TURISMO	1981-	IMS-5	NE-8
	254	-	IMS-5P	
	V 35	1984-		
	V 35 C	1984-1986		
	V 35 F.	1984-		
	V 35 II	1984-		
	V 35 III	1984-		
	V 35 IMOLA	1984-		
	V 1000 I LE.	1984-		
	V 1000 IDRO.	1984-		
	V 1000 II L.	1984-		
	250 ELECTR.	-	FEM-2D FEM-2I	NE-8
	250 TS	-	FEM-2D	NE-6
	350 GTS	-	FEM-2I	NE-6P
	350	1979-	IMS-5	NE-6
	500	-	IMS-5P	NE-6P
	850 T5	1986-		
	SP 1000 II	1984-		
	V 1000 CALI.	1984-		
	V 1000 CONV.	1984-		
	V 1000 GT	1984-		
	V 1000 SP	1984-		
	V 1000 SP II	1984-		
	350 NEVADA	1994	ZA-1	ZA-1
	750 NEVADA	1994-	ZA-1P	ZA-1P
	750	1979-	FEM-1D	NE-6
	850 LE MANS	1979-1981	FEM-1I	NE-6P
850 T3	1979-1986	SIP-3		
850 T3 C.	1979-1981			
V 1000 C.	1979-			
750 NTX	1990-	ZA-1	NE-8	
V 75 NTX	1990-	ZA-1P		
850 GT	1986-	FEM-1D FEM-1I	NE-6 NE-6P	
1000 GT RL	1990-	IMS-5	ZA-1	
1000 GT RR	1990-	IMS-5P	ZA-1P	
1000 LE MANS	1990-			
1000 S	1990-			
1000 ST II	-			
1000 ST III	-			
V 35 C	1986-			
V 35 GT	1986-			
V 35 NTX	1986-			
V 35 TT	1986-			
BREVA	2003-	ZA-9P1	ZA-9P1	
CALIFOR. EV	2003-			
V 11	2003-			



MARCA BRAND	MODELO MODEL			
MOTO GUZZI	FAL.SAHARA	-	FEM-1D	
	V 7 SPORT	-	SIP-3	NE-6 NE-6P
	V 1000 G5	1979-	IMS-5 IMS-5P	IMS-5 IMS-5P
MOTO MORINI	3 1/2 SPO.	1981-	FEM-1D	NE-6
	3 1/2 V	1981-	FEM-1I	NE-6P
	125 T	1981-		
	250	1981-		
	250 BIC	1981-		
	500 GV	-		
	500 KANGEROO	-		
	500 T/S	-		
	50 CORSARIO	-		NE-6
	125 CORSARIO	-		NE-6P
	250 KANGURO	1979-		
	250 STRADA	1979-		
	550	1979-		
	125 H	1984-	FEM-2D	ZA-1
	125 KJ	1984-	FEM-2I	ZA-1P
	350 COGUARO	1986-	AF-6D	ZA-1
	350 EXCALIB.	1986-		ZA-1P
	350 KANGURO	1986-		
	350 NEW YORK	1986-		
	350 XE	1986-		
	501 COGUARO	1986-		
	501 EXCALIB.	1986-		
	501 KANGURO	1986-		
501 NEW YORK	1986-			
500 CAMEL	-	AF-6D	NE-8	
MOTOBECANE	125 LT	-	LAS-X	NE-6
	SUPERMOBY 51	-		NE-6P
MOTOBI	254	-	IMS-5 IMS-5P	NE-8
MOTRON	3/TRE-RCV	-		ZA-1
	MST	-		ZA-1P
	RA PL 4P	-		
	SU 3R 1D	-		
	TAXI AP	-		
	TAXI ES 1D	-		
	COMPACT	1990-1991	ZA-1	ZA-1
	GL 4	1990-1991	ZA-1P	ZA-1P
	GTO	1990-1991		
	INVADER	1990-1991		
SHOPPING	1990-1991			
TAXI ES ID	1990-1991			
TAXI KS SL	1990-1991			
MV AUGUSTA	125 S	-	FEM-1I	
	125 SPORT	-		FEM-1I
	350 SPORT	-		FEM-2I
	350 S	-	AF-7I AF-7IP	AF-7I AF-7IP
	750 S	-	SUZU-13P SUZU-4I	NE-6 NE-6P



# MOTOCICLETA

## MOTORCYCLE

MARCA BRAND	MODELO MODEL			
<b>MV AUGUSTA</b>			SUZU-4IP	
<b>MZ</b>	TOUR	1994	ZA-4DP	
<b>NORTON</b>	850 COMMANDO	-	UN-3	
<b>OMC</b>	CITY	-		ZA-1
	ELITE	-		ZA-1P
	ELITE SL	-		
	ELS-SL	-		
	EXCLAIM	-		
	HI TECH	-		
	MARINER-SL	-		
	MUDDY	-		
	MUDDY JUNIOR	-		
	WILD ELITE	-		
	WILD MS	-		
	WILD TIGRE	-		
<b>OSSA</b>	125	-	CAS-1D	NE-6
	250 ENDURO	-		NE-6P
	350 ENDURO	-		
	250 DESERT	-		CL-2I
	250 EXPLORER	-		CL-3I
	250 FUEGO	-		
	250 ORANGE	-		
	250 SUPER	-		
	250 TRIAL	-		
	250 TU	-		
	250 TURISMO	-		
	250 YO	-		
	350 EXPLORER	-		
	350 ORANGE	-		
	350 TRIAL	-		
	TRIAL 303	-		
	TRIAL JELLOW	-		
<b>PERIPOLI</b>	COLORADO	-		ZA-1
	DAY LXR/SA	-		ZA-1P
	DAY S 5/K	-		
	GIULIETTA	-		
	MINI L SAM1K	-		
	OXFORD	-		
	OXFORD ROAD	-		
	TIR	-		
	VAI M03	-		
	VAI R	-		
	WILD	-		
<b>PEUGEOT</b>	BUXY	1994-1997	ZA-12	ZA-12
	FOR LUX	1994-1998		
	SPEEDAKE	1995-1997		
	SQUAB	1995-1996		
	ZENITH	1994-1996		
	LOOXOR	2001		NE-45
	LUDIX	2004		NE-45P
	SPEEDFIGHT	1997		
	SV GEO	1991-1995		
	TREKKER	1998		
	VIVACITY	1999		



MARCA BRAND	MODELO MODEL			
<b>PEUGEOT</b>	X-RACE	2003		
	SC 50 L SCO.	-	SUZU-13P	SUZU-13P
	SC 80 L SCO.	-	SUZU-4I	SUZU-4I
	ST 50 L SCO.	-	SUZU-4IP	SUZU-4IP
	SV 125 SCO.	-		
	SQUAB	1997	NE-45P	
	SV 50 GEO	1992-	NE-45	NE-45
	SV 80 GEO	1993-	NE-45P	NE-45P
	SV 125 GEO	1993-		
<b>PGO</b>	COMET	2000-	PGO-2P	
	PMS	2000-		
	PMX	2000-		
	RODOSHOW	2000-		
	TREX	2000-		
	SCOOTER	-	PGO-1	
<b>PIAGGIO</b>	APE 600 MP	1979-1981		AF-6D
	APE CAR	-	AF-9D	FAB-1
	APE CAR P3	-	AF-9DP	
	APE CARP 601	-	AF-9I	
			AF-9IP	
			FEM-1D	
			FEM-1I	
	APE P 50	-	FEM-1D	NE-6
	APE TM P 50	-	FEM-1I	NE-6P
	VESPA 50	1979-1983		
	VESPA 50 ES	1981-1983		
	APE TM 703	-	AF-9D	FAB-1
	NICA 125	-	AF-9DP	
			AF-9I	
			AF-9IP	
	BOSS 50	1986-		ZA-1
	BRAVO	1992-		ZA-1P
	BRAVO 50	1986-		
	CIAO	1992-		
	CIAO 50	1986-		
	GRILLO	1992-		
	GRILLO 50	1986-		
	SI	1992-		
	SI 50	1986-		
	BOXER 50	1982-1986		NE-8
	BRAVO 50	1982-1986		ZA-1
	CIAO 50	1982-1986		ZA-1P
	SI 50	1982-1986		
	CARNABY	2007		FI-13P1
	FLY	2005-2012		
	SKIPPER	1999-2000		
	VESPA	1996		
	ZIP	2000-2011		
	COSA 125	1988-	ZA-2P	ZA-2P
	COSA 150	1988-		
	COSA 200	1988-		
	SFERA	1992-		
	VESPA 50 PK	1986-		
	VESPA FL 2	1986-		



MARCA BRAND	MODELO MODEL			
PIAGGIO	VESPA PLURI.	1986-		
	VESPA RUSH	1986-		
	COSA 125 MA	1992-	FI-1	FI-1
	COSA 150 MA	1992-	FI-1P	FI-1P
	COSA 2 125	1993-	ZA-2P	ZA-2P
	COSA 2 150	1993-		
	COSA 2 200	1993-		
	COSA 200 MA	1992-		
	VESPA 125 E	1984-		
	VESPA P 125	-		
	VESPA P 125	1984-1991		
	VESPA PK 125	-		
	VESPA PX 125	1984-1991		
	VESPA PX 150	1984-1991		
	VESPA PX 200	1984-		
	FREE RL	1995	ZA-7DP	
	HEXAGON 125	1994-1997	ZA-4DP	ZA-4DP
	NRG	2002-2005		ZA-7DP
	SKIPPER	1993-1998		
	TYPHOON	1994-2010		
	ZIP	1994-1999		
	NRG	2006		ZA-9P
	QUARTZ	1992-	ZA-2P	ZA-2P
	VESPA 50	1992-	ZA-7DP	ZA-7DP
	ZIP	1992-1993		
	SCATTO	-1991	ZA-13P	ZA-13P
	SFERA	1995-1998	ZA-7DP	ZA-7DP
	TOLEDO-SC	-		CL-2I CL-3I
	VESPA 125 E	1981-1984		NE-6
	VESPA 150	1979-		NE-6P
	VESPA 150 RA	1979-		
	VESPA 150 SV	1979-		
	VESPA P 80X	-		
VESPA P 125X	1981-			
VESPA P 150X	1981-			
VESPA P 200X	1981-			
VESPA PX 200	1986-			
VESPA PX125E	1981-			
VESPA 125 ET	1979-	FEM-1D	ZA-1	
VESPA 200 PX	1979-	FEM-1I	ZA-1P	
VESPA P 150X	1979-1981			
VESPA 125ET3	-1979	FEM-1I	NE-6 NE-6P	
VESPA PK 50	1984-1986	FI-1	FI-1	
VESPA PK 50S	1984-1986	FI-1P	FI-1P	
RALEIGH	CICLI	-		LF-2
	CYCLES	-		UN-FP
RIZZATO	ATALA	1995	ZA-4DP	
	HACKET AT12	1995		
	HACKET RACI.	1995		
SULKI	50	-1992	BH-4	BH-4
	125	1992-		
SUZUKI	400 ENDURO	1978-	SUZU-13P	



MARCA BRAND	MODELO MODEL			
SUZUKI	400 S	1978-	SUZU-4I	
	GS 400 T	-	SUZU-4IP	
	GT 350	1978-		
	GT 500	1978-		
	650 DJEBEL	-1991	SUZU-13P	SUZU-13P
	DR 125 S	-	SUZU-4I	SUZU-4I
	DR 250 S	1984-	SUZU-4IP	SUZU-4IP
	DR 400	1980-1985		
	DR 500	1984-1986		
	DR 600	1985-		
	DR 650	1990-1991		
	DR 750 BIG	1988-1991		
	DR 800 SL	1990-		
	GS 125 ES	1984-		
	GS 550	1984-1985		
	GS 850	1980-1982		
	RGT 125	-		
	TS 125 S	-		
	TS 125 X	-		
	ADDRESS	1992-	SUZU-11D	SUZU-11D
	ADDRESS 100	1994	SUZU-11DP	SUZU-11DP
	DR 350 SE	1994		
	DR 650	1992-		
	GS 400	1993-		
	GS 500	1989-		
	GS 750	1991-		
	GSF 400	1993-	SUZU-13P	SUZU-13P
	GSF 500 EP	1993-	SUZU-4I	SUZU-4I
	GSF 600	1995	SUZU-4IP	SUZU-4IP
	GSX 600	1989-1997	SUZU-5	SUZU-5
	GSX 750	1988	SUZU-5P	SUZU-5P
	GSX 1100 92	1992-	SUZU-13P	NE-8
	GSXR 750	1989-1996	SUZU-4I	SUZU-13P
	GSXR 1100	1990-	SUZU-4IP	SUZU-4I
	RF 600 R	1993-	SUZU-5	SUZU-4IP
	RF 900 R	1994-	SUZU-5P	SUZU-5
	RG 125	1995		SUZU-5P
	RS 650	1991	SUZU-12DP	
	VS 750	1989-		
	VS 800	1992-		
	VS 1400	1990-		
	VX 800	1990-		
	AH 50	1991-	YAMA-20I	YAMA-20I
CP 50	1991-	YAMA-24IP	YAMA-24IP	
		YAMA-28P	YAMA-28P	
AJ 50 ZZ	1995	ZA-4DP	ZA-4DP	
AP 50	1995			
AN 125	1995	YAMA-23DP	NE-8	
VS 600 GL	1995	YAMA-23IP		
VS 800 GL	1995			
CC 1	-	SUZU-13P	NE-8	
RV 90	-	SUZU-4I		
		SUZU-4IP		
DL 1000	2003-	SUZU-12DP	SUZU-12DP	



# MOTOCICLETA

## MOTORCYCLE

MARCA BRAND	MODELO MODEL			
SUZUKI	DR 650 RSE	1995-	YAMA-19D	YAMA-19D
	GS 500 F	2004-	YAMA-19DP	YAMA-19DP
	GS 500 E	1995-	YAMA-19I	YAMA-19I
	GSF 600	1995-	YAMA-19IP	YAMA-19IP
	GSF BANDIT	2004-	YAMA-20D	YAMA-20D
	GSX R1300	2004-	YAMA-20I	YAMA-20I
	GSXR 750 SP	1995-	YAMA-20IP	YAMA-20IP
	GSXR 750 W	1995-	YAMA-22DP	YAMA-22DP
	GSXR 1000	2003-	YAMA-22IP	YAMA-22IP
	GSXR 1100	1995-	YAMA-23DP	YAMA-23DP
	GZ 250	2004-	YAMA-23IP	YAMA-23IP
	LR GSX 600	2004-	YAMA-24DP	YAMA-24DP
	SV 650 S	2003-	YAMA-24IP	YAMA-24IP
	SV 1000 S	2003-	YAMA-28P	YAMA-28P
	SV 650	2004-	YAMA-29P	YAMA-29P
	SV 750	2004-	AF-6D	NE-6
	VL 800	2004-		
	V-STROM 650	2004-		
	V-STROM 1000	2004-		
	VZ 1600	2004-		
	DR 125 SE	1995	YAMA-20D	NE-8
	LS 650	1995	YAMA-20I	
	VS 1400 GLP	1995	YAMA-20IP	
	DR 350	1997	YAMA-20I	
	DR 350 S	1993-	YAMA-20D	NE-8
	DR 350 SM	1992-	YAMA-20I	
	DR 350 SN	1992-	YAMA-24DP	
	VS 750 J.	-	YAMA-24IP	
			YAMA-28P	
	G 450 L	1980-	SUZU-5	SUZU-5
	GN 400	1985-	SUZU-5P	SUZU-5P
	GNX 250	1985-1991		
	GR 650	1982-		
	GS 450	1980-		
	GS 500	1984-1989		
	GS 550	1982-1984		
	GS 750	1982-1987		
	GS 850	1982-1985		
	GSX 250 S	1985-1991		
	GSX 400	1985-		
	GSX 500	1989-		
	GSX 550	1985-		
	GSXR 1100	1981-		
	LS 650	1982-		
	LT 250 A	1985-1991		
	RG 250 R	1985-1991		
	RGV 250	1985-1991		
	GS 1000	1982-1985	SUZU-13P	SUZU-13P
	GSX 1100	1981-1985	SUZU-4I	SUZU-4I
	RG 500	1985-	SUZU-4IP	SUZU-4IP
		SUZU-5	SUZU-5	
		SUZU-5P	SUZU-5P	
GSX 600	1998-2006		SUZU-12D	
GSX 750	1988-2006		SUZU-12DP	



MARCA BRAND	MODELO MODEL			
SUZUKI	GSX 1300 HA.	1999-2006		
	TL 1000	1997-2002		
	TU 125	1999		
	TU 250	1997-2001		
	GSX 1200	1999-2000		
	GSX 1400	2002-2005		
	GZ 125	1998		
	RV 125	2003		
	XF 650	1997-2001		
	GSX 750	1981-1987	SUZU-13P	NE-8
			SUZU-4I	SUZU-13P
			SUZU-4IP	SUZU-4I
			SUZU-5	SUZU-4IP
			SUZU-5P	SUZU-5
				SUZU-5P
	GSXR 600	1997	SUZU-12DP	
	GSXR 750	1997		
	GT 550	1978-	SUZU-3I	
	GT 750	1978-		
	INTRUDE.1400	1993-	YAMA-19D	NE-8
	VS 800 GL	1993-1995	YAMA-19DP	
			YAMA-19I	
			YAMA-19IP	
			YAMA-23DP	
			YAMA-23IP	
			YAMA-29P	
	KATANA	1997	ZA-4DP	
	KATANA R	2004-	ZA-9P1	ZA-9P1
	VS 750 INT.	1986-	YAMA-18D	YAMA-18D
			YAMA-18DP	YAMA-18DP
		YAMA-18I	YAMA-18I	
		YAMA-18IP	YAMA-18IP	
		YAMA-19D	YAMA-19D	
		YAMA-19DP	YAMA-19DP	
		YAMA-19I	YAMA-19I	
		YAMA-19IP	YAMA-19IP	
		YAMA-20D	YAMA-20D	
		YAMA-20I	YAMA-20I	
		YAMA-20IP	YAMA-20IP	
		YAMA-22DP	YAMA-22DP	
		YAMA-22IP	YAMA-22IP	
		YAMA-23DP	YAMA-23DP	
		YAMA-23IP	YAMA-23IP	
		YAMA-24DP	YAMA-24DP	
		YAMA-24IP	YAMA-24IP	
		YAMA-28P	YAMA-28P	
		YAMA-29P	YAMA-29P	
SWM	124 RZ	-	AF-6D	NE-6
	280 GS	-		NE-6P
	EXPLORER 125	-		
	EXPLORER 350	-		
	GS 125	-		
	GT 125	-		
GTS 125	-			



MARCA BRAND	MODELO MODEL			
SWM	RS 125	-		
	RS 250	-		
	TL 329	-		
	350 XN	-	ZA-1	ZA-1
			ZA-1P	ZA-1P
	WPM 1	-		NE-6 NE-6P
TESTI	CRICHET PULL	-		NE-6 NE-6P
TRIUMPH	AMERICA	2006-	TRP-1D	
	BONNEVILLE	2006-	ZA-9P1	
	DAYTONA	2006-		
	ROCKET III	2006-		
	SCRAMBLER	2006-		
	SPEEDMASTER	2006-		
	SPRINT ST	2006-		
	THRUXTON	2006-		
	TIGER	2006-2009		
		TRIDENT	-	UN-3
YAMAHA	250 COMPETI.	-	YAMA-3I	YAMA-3I
	400	-	YAMA-14I	YAMA-14I
	RD 400	-	YAMA-15D	YAMA-15D
			YAMA-15I	YAMA-15I
	400 BICILIN.	-	YAMA-17D	YAMA-17D
			YAMA-17I	YAMA-17I
	500	1979-	YAMA-9I	YAMA-9I
	500 ENDURO	1979-	YAMA-14I	YAMA-14I
	RD 500	1979-		
	TT 350	1995		
	600 ACERBIS	1980-	YAMA-14D	YAMA-14D
	OHC 650	1980-	YAMA-14I	YAMA-14I
	RD 50 M	-		
	XT 50	-		
	AEROX	1998	ZA-9P1	ZA-9P1
	BT 1100 BU.	2003-		
	MAJESTY 250	2005-		
	NEOS	1998		
	VERSITY 300	2003-		
	AXIS	1995-	ZA-4DP	ZA-4DP
	BREEZE	1994		
	BREEZE	1995-		
	SPY	1995-		
	BL 125 BE.	1984-1991	YAMA-18D	NE-8
	DT 125 BA.	1984-1991	YAMA-18DP	
	DT 125 BB.	1984-1991	YAMA-18I	
	DT 125 CF.	1984-1991	YAMA-18IP	
DT 125 R	1984-1986	YAMA-19D		
FZ 400	1984-	YAMA-19DP		
FZR 400	1984-	YAMA-19I		
FZR 600	1984-1992	YAMA-19IP		
RD 350	1984-1991	YAMA-20D		
RD 350 LC	1984-1991	YAMA-20I		
RD 550	1984-	YAMA-20IP	YAMA-14D	

MARCA BRAND	MODELO MODEL			
YAMAHA	RT 125 LL	1984-1991	YAMA-22DP	YAMA-14I
	SCROW 225	1984-1991	YAMA-22IP	YAMA-15D
	SR 250	1984-1991	YAMA-23DP	YAMA-15I
	SR 250 SE	1984-	YAMA-23IP	YAMA-3D
	SR 250 SP.	1984-	YAMA-24DP	YAMA-3I
	SR 500 G-S	1984-	YAMA-24IP	YAMA-21I
	SR 600	1984-	YAMA-28P	YAMA-21IP
	TDR 125	1984-1991	YAMA-29P	
	TDR 250	1984-1991		
	TR 1	1984-		
	TZR 125	1984-1991		
	TZR 250	1984-1991		
	XD 250 LC	1984-		
	XJ 600	1984-		
	XJ 650 SP.	1984-		
	XJ 650 TT.	1984-		
	XJ 750 NS	1984-		
	XJ 750 SE.	1984-		
	XJ 900 F	1984-		
	XJ 900 S	1984-		
	XS 350	1984-1991		
	XS 850	1984-		
	XT 400 SP.	1984-		
	XT 500	1984-		
	XT 550	1984-		
	XT 600	1984-1991		
	XT 600 4V.	1984-1991		
	XT 600 N	1984-		
	XT 600 TE.	1984-1991		
	XT 600 YD.	1984-		
	XT 600 Z-ZA	1984-1991		
	XU 500 SE	1984-		
	XV 535	1984-		
	XV 1000 SE	1984-		
	XZ 550 LC-S	1984-		
	YZ 125 LC	1984-1991		
	YZ 250 LC	1984-1991		
	YZ 490	1984-		
	BL 125 BE.	1991-	YAMA-18D	NE-8
	DT 125 BA.	1991-	YAMA-18DP	
	DT 125 BB.	1991-	YAMA-18I	
	DT 125 CF.	1991-	YAMA-18IP	
DT 125 R	1991-1992	YAMA-19D		
RD 350	1991-	YAMA-19DP		
RD 350 LC	1991-	YAMA-19I		
RT 125 LL.	1991-	YAMA-19IP		
SCROW 225	1991-	YAMA-20D		
SR 250	1991-	YAMA-20I		
TDR 125	1991-1992	YAMA-20IP		
TDR 250	1991-			
TT 350	1991-1995			
TZR 125 R	1991-1992			
TZR 250	1991-			
XT 600	1991-			



# MOTOCICLETA

## MOTORCYCLE

MARCA BRAND	MODELO MODEL			
YAMAHA	XT 600 4V.	1991-		
	XT 600 TE.	1991-		
	XT 600 Z-ZA	1991-		
	YZ 125 LC	1991-		
	YZ 250 LC	1991-		
	CR 50 Z	1992-	YAMA-27	YAMA-27
	CT 50 S	1992-	YAMA-27P	YAMA-27P
	SCOOTER MBK	1991-		
	CT 50 SS	1995	YAMA-27DP	YAMA-27DP
			YAMA-27P	YAMA-27P
	DT 125	-1985	YAMA-3D	YAMA-3D
	DT 125 LC.	-1985	YAMA-3I	YAMA-3I
	TX 650	1979-		
	TX 750	1979-		
	DT 125	1992-	YAMA-18D	YAMA-18D
	DT 125 B	1992-	YAMA-18I	YAMA-18I
	DT 125 R	1992-	YAMA-19D	YAMA-19D
	DT 125 Z	1992-	YAMA-19I	YAMA-19I
	TT 600	1993	YAMA-20D	YAMA-20D
	TT 600 S	1991-	YAMA-20I	YAMA-20I
	TZR 125 R	1992-	YAMA-22DP	YAMA-22DP
	TZR 125 RSP	1992-	YAMA-22IP	YAMA-22IP
	XT 600 A	1993-	YAMA-23DP	YAMA-23DP
	XT 600 E	1991-	YAMA-23IP	YAMA-23IP
	XT 600 ZA	1991-1992	YAMA-24DP	YAMA-24DP
			YAMA-24IP	YAMA-24IP
			YAMA-28P	YAMA-28P
			YAMA-29P	YAMA-29P
	DT 125 CO.	1986-1992	ZA-1	ZA-1
	DT 125 LC.	1986-1992	ZA-1P	ZA-1P
	DT 125 R	1986-1991		
	DT 250	-	YAMA-14D	YAMA-14D
	DT 250 MX	-	YAMA-14I	YAMA-14I
	RD 250	-	YAMA-15D	YAMA-15D
			YAMA-15I	YAMA-15I
			YAMA-3D	YAMA-3D
			YAMA-3I	YAMA-3I
	FJ 1100	1984-	YAMA-21I	YAMA-21I
	FJ 1200	1984-	YAMA-21IP	YAMA-21IP
	FS 1200	1984-		
	FZ 600	1984-	YAMA-23IP	
	FZ 600 GE.	1984-	YAMA-24DP	
FZ 750 A-R	1984-	YAMA-24IP		
FZR 600	1992-	YAMA-28P		
FZR 1000	1984-	YAMA-29P		
FZR 1000 E.	1984-	YAMA-5D	YAMA-5D	
FZX 750	1984-	YAMA-5I	YAMA-5I	
GENESIS FZR	1992-	YAMA-14I	NE-8	
RD 500 YP.	1984-			
SUPER T. 750	1992-			
TDM 850	1991-	YAMA-18I	ZA-1	
TT 350	1984-1991	YAMA-18IP	ZA-1P	
TT 600 S	1984-1991	YAMA-19I	ZA-1	

MARCA BRAND	MODELO MODEL			
YAMAHA	V MAX 86	1984-	YAMA-19IP	ZA-1P
	VMX 12 N	1984-	YAMA-20D	YAMA-20D
	XJ 400	1984-		
	XJ 600 N	1984-		
	XJ 650 T	1984-		
	XJ 650 TU.	1984-		
	XJ 750 N	1984-		
	XJ 750 S.	1984-		
	XTZ 750	1984-		
	XTZ 750 T.	1984-		
	XV 500 SE	1984-		
	XV 750 SE	1984-		
	XV 1000 V.	1984-		
	XV 1100	1984-		
	XZV 12 T	1984-		
	XZV 12 TD	1984-		
	XZV 13 TD	1984-		
	FRZ 600	1995-	YAMA-26	YAMA-26
	FRZ 600 R	1994-	YAMA-26D	YAMA-26D
	FZX 600 R	1995-	YAMA-26DP	YAMA-26DP
	GTS 1000	1993-	YAMA-26P	YAMA-26P
	GTS 1000 ABS	1993-		
	TDM	1996-		
	TDM 850	1995-		
	TRX 850	1995-		
	XJ 600 E	1995-		
	XJ 600 S D.	1995-		
	XJ 900 S D.	1995-		
	XT 500	1979-1984		
	XT 600 E	1995-		
	XTZ 660	1994-		
	XVS 110 D.S.	1998-		
	XVS 650	1996-		
	XVZ 1300	1996-		
	YP 250 MAJES	1996-		
	YZF 600	1996-		
	YZF 750 R	1993-		
	YZF 750 SP	1993-		
	YZF 1000	1996-		
	FS 1	-1986	YAMA-16D	YAMA-16D
	RD 125	-1986	YAMA-16I	YAMA-16I
			YAMA-3D	YAMA-3D
		YAMA-3I	YAMA-3I	
FZX 600 R	1994	YAMA-19D	YAMA-19D	
TW 200	1994	YAMA-19DP	YAMA-19DP	
FZX 600 R	1995	YAMA-19I	NE-8	
TW 200	1995	YAMA-23IP		
		YAMA-29P		
FZX 750	1995	YAMA-18D	NE-8	
		YAMA-22DP		
RD 350	-	YAMA-3D	YAMA-3D	
XS 500 B	1979-	YAMA-3I	YAMA-3I	
		YAMA-9D	YAMA-9D	



MARCA BRAND	MODELO MODEL			
YAMAHA			YAMA-9I	YAMA-9I
	RD 500 LC	1984-	YAMA-18D	NE-8
	XJ 550	1984-	YAMA-18DP	YAMA-21I
	XS 400	1984-	YAMA-18I	YAMA-21IP
			YAMA-18IP	
			YAMA-19D	
			YAMA-19DP	
			YAMA-19I	
			YAMA-19IP	
			YAMA-20D	
			YAMA-20I	
			YAMA-20IP	
			YAMA-21I	
			YAMA-21IP	
			YAMA-22DP	
			YAMA-22IP	
			YAMA-23DP	
			YAMA-23IP	
			YAMA-24DP	
			YAMA-24IP	
			YAMA-28P	
			YAMA-29P	
	RS 125 C.	-1986	YAMA-5D	YAMA-5D
			YAMA-5I	YAMA-5I
	SR 500 G	1979-1984	YAMA-14I	NE-8
	SR 500 S	1979-1984		
	XT 500	1979-1984		
	TDR 125	1992-	YAMA-18I	ZA-1
	TDR 125 R	1992-	YAMA-18IP	ZA-1P
	TDR 125 R	1990-1991	YAMA-19I	ZA-1
			YAMA-19IP	ZA-1P
	TT 600	1994	YAMA-20D	YAMA-20D
	TT 600 E	1994		
	XT 600 A	1994		
	XT 600 E	1994		
	TT 600	1995	YAMA-20I	YAMA-20I
	XT 600 A	1995	YAMA-24IP	YAMA-24IP
	XT 600 E	1995	YAMA-28P	YAMA-28P
	XC 125 CYGN.	1995	YAMA-18D	YAMA-18D
			YAMA-22DP	YAMA-22DP
	XS 500	1979-	YAMA-13D	YAMA-13D
	XS 500 EV.	1985-	YAMA-13I	YAMA-13I
XS 750	1979-	YAMA-13I	YAMA-13I	
XS 1100	1984-	YAMA-13D	NE-8	
XS 1100 S	1984-	YAMA-13I		
XT 250	1990-	YAMA-17I	NE-8	
YPUS 125	1990-			
XT 400	-	YAMA-14D	NE-8	
YSR 50	1990-	YAMA-18D	NE-8	
		YAMA-18I		
		YAMA-22DP		
		YAMA-22IP		









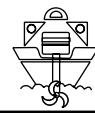

**THE KEY TO EXCELLENCE**  
GLOBALLY UNLOCKING MILLIONS OF DOORS DAILY











REFERENCIA REFERENCE	TIPO TYPE
ALP-11 ALP-2 ALP-2D ALP-6 ALP-6D CHI-1T COB-1P COB-2 DOM-11D DOM-11I GH-3 HU-NW NE-60C1 NE-60C2 PO-2P STS-X5 STS-X6 VA-61C1 VA-61C2 YW-1P ZA-3D ZA-5DP ZA-5P	ALARMA ALARM  
BOB-1D CN-1D MIT-1D MIT-1DP MIT-1I MIT-1IP MIT-2D MIT-2DP MIT-2I MIT-2IP TOYO-25 YA-11D YA-11I YA-27 YA-27D	AVION AEROPLANE  
ABU-3 ABU-13 ABU-13D ABU-18DP ABU-18P ABU-19D ABU-19DP ABU-19P ABU-21 ABU-35P ABU-36P ABU-40 ABU-42 ABU-42D ABU-45 ABU-64P ABU-65P ABU-72P AF-19 AF-19P	BICICLETA BICYCLE  

REFERENCIA REFERENCE	TIPO TYPE
AF-21 AF-21P AS-2D AS-2I AS-17D AS-21 AS-21D AS-21DP AS-21P AX-1 AX-1D AX-1DP AX-1P AX-2P AX-3DP AX-4DP CI-4DP CI-4IP CI-5DP CI-5IP COB-1P COB-2 FAR-1D FAR-1I FAR-2D FAR-2I FAR-3 FAR-3D FAR-4D IMS-3 IMS-3P IMS-5 IMS-5P IMS-13 IMS-13P IN-1 IN-4 IN-5 LAS-2 LAS-3 LAS-4 LAS-4D LAS-5 LAS-5D LAS-6 LAS-6D LAS-FH LAS-KT LAS-TK LAS-U LAS-X LF-1D LF-1I LF-5 LF-5D LF-15 LF-15D LF-17 LF-32	BICICLETA BICYCLE  

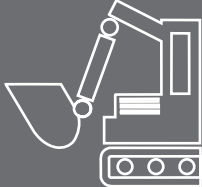
REFERENCIA REFERENCE	TIPO TYPE
LUMA-1D LUMA-1I LUMA-2D LUMA-2I LUMA-3D LUMA-3I LUMA-4D LUMA-4I MQ-1D MQ-1I NE-30 NE-30P NE-31 NE-31P NE-32 NE-32P RI-1D RI-1I RI-2D RI-2I RI-3D RI-3I STS-X6 TOK-4D UN-1FS UN-2 UN-3 UN-4 UN-44 UN-44D UN-FFE UN-FK UN-FP UN-FR UN-FS UN-MRN UN-NG VI-4DP VI-4IP YA-11D YA-11I ZA-1 ZA-1P ZA-2P ZA-3D ZA-4DP ZA-10	BICICLETA BICYCLE  
AF-19 AF-19P AF-21 AF-21P AU-AN AU-ANP DOM-3D DOM-3I DOM-4 DOM-4D DOM-6D DOM-6I	CARAVANA CARAVANS  

<b>REFERENCIA REFERENCE</b>	<b>TIPO TYPE</b>	<b>REFERENCIA REFERENCE</b>	<b>TIPO TYPE</b>	<b>REFERENCIA REFERENCE</b>	<b>TIPO TYPE</b>				
DOM-8D EU-12 EX-1D FAB-1 FLO-2D GH-2 GH-GX GH-HX HU-SC HU-SR HU-SU HU-SX HU-SY HU-SZ IMS-3 IMS-3P IMS-5 IMS-5P IMS-13 IMS-13P JUNI-2 JUNI-2D JUNI-9D LF-1D LF-11 LF-5 LF-5D LF-6 LF-15 LF-15D LF-17 LF-32 NE-6 NE-6P UN-1FS UN-2 UN-3 UN-44 UN-44D UN-FFE UN-FK UN-FP UN-FR UN-FS UN-FT UN-MRN UN-NG UN-TF VO-AH VO-AHP VO-HV VO-HVP VO-M VO-MP VO-N VO-NP VO-R VO-RP VO-VB	CARAVANA CARAVANS	VO-VBP WA-5DP WA-5IP WAS-1 WAS-7D WAS-7I WAS-9 WAS-9D YA-11D YA-11I YA-27 YA-27D  AF-7D AF-7I AF-7IP AF-7IP1 AF-8D AF-8DP AF-8I AF-8IP AF-9D AF-9DP AF-9I AF-9IP BH-1 BH-1P BH-2 BH-3 BH-4 BH-5 BH-6 BH-8 CIT-2 DAE-5P DAV-1 DAV-1P FIA-1 MERI-1D MERI-1DP PRE-1I PRE-3 TEU-1 TOYO-27  AF-7D AF-7I AF-7IP AF-7IP1 AF-8D AF-8DP AF-8I AF-8IP AF-9D AF-9DP AF-9I AF-9IP BH-1 BH-1P BH-2 BH-3 BH-4 BH-5 BH-6 BH-8 CIT-2 DAE-5P DAV-1 DAV-1P FIA-1 MERI-1D MERI-1DP PRE-1I PRE-3 TEU-1 TOYO-27	CARAVANA CARAVANS	CARRETILO ELEVADORA FORKLIFT	BH-4 BH-5 BH-6 BH-8 CIT-2 DAE-5P DAV-1 DAV-1P FIA-1 MERI-1D MERI-1DP PRE-1I PRE-3 TEU-1 TOYO-27  AF-7D AF-7I AF-7IP AF-7IP1 AF-8D AF-8DP AF-8I AF-8IP AF-9D AF-9DP AF-9I AF-9IP BH-1 BH-1P BH-2 BH-3 BH-4 BH-5 BH-6 BH-8 CIT-2 DAE-5P DAV-1 DAV-1P FIA-1 JD-1 JD-2 JD-3D JD-4D KOM-1 MAK-1 MERI-1D MERI-1DP PRE-1I PRE-3 TEU-1 TOYO-27  BAS-4 BH-1 BH-1P BH-8	CORTA CESPED LAWN MOWER	CORTA CESPED LAWN MOWER	ESCAVADORA EARTH MOVING MACHINE	MOTOR MARINO BOAT ENGINES
									

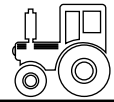

REFERENCIA REFERENCE	TIPO TYPE	REFERENCIA REFERENCE	TIPO TYPE	REFERENCIA REFERENCE	TIPO TYPE
BK-4 BK-4D BK-5D BK-5I BS-1I BS-4D BS-6 BS-7 BS-7D BS-8 BS-8D BS-9 BS-9D CHI-1 CHI-2 CHI-3 CHI-4 CHI-5 CLU-1D CLU-1I CLU-2 CLU-3 CLU-4 CLU-5 HUD-1 HUD-1D KEN-1 KEN-1D MIT-1D MIT-1DP MIT-1I MIT-2D MIT-2DP MIT-2I MIT-2IP NE-1 NE-1D NE-1DP NE-1P NE-58D PLL-1 WST-1D WST-2D YA- 8D YA- 8I YA- 9I YA-11D YA-11I YA-27 YA-27D YA-37 YA-37D	MOTOR MARINO BOAT ENGINES	AF-21 AF-21P BL-2 BL-3 BL-4 BL-4D BL-6 BL-6D ECH-1 FAB-1 FAR-1D FAR-1I FAR-2D FAR-2I FAR-3 FAR-3D FAR-4D GIU-1 GIU-1D GIU-2 GIU-2D IMS- 3 IMS- 3P IMS- 5 IMS- 5P IMS-13 IMS-13P RO-5D RO-5I SI-1D SI-2D SI-3 SI-3D SI-4D VO-1 ZA-2P ZA-4DP	PORTA ESQUIS	DAR-1 FAB-1 FAB-2 FAR-1D FAR-1I FAR-2D FAR-2I FAR-3 FAR-3D FAR-4D FIA-2 GAS-1 GAS-1D GIOB-1D GIOB-1DP GIOB-2I GIOB-2IP HA-1D HA-1I HU-P IMS- 3 IMS- 3P IMS- 5 IMS- 5P IMS-13 IMS-13P LAS-2 LAS-3 LAS-4 LAS-4D LAS-5 LAS-5D LAS-FH LAS-R LAS-U LAS-V LAS-X LAS-Y PJ-1 PJ-2 PJ-2P PJ-3 PJ-K PJ-KP SI-1D SI-2D SI-3 SI-3D SI-4 SI-4D SI-5D VO-1 VO-6D WAS-1 WAS-3 WAS-3P WAS-4 WAS-4P	TAPON DE GASOLINA PETROL CAP
AF- 5D AF- 5I AF- 6D AF- 6I AF-19 AF-19P	PORTA ESQUIS SKI HOLDER	AB- 4D AB- 6D AB- 6I AB- 7I AB- 8D AB- 8I AB-10I AF- 5D AF- 5I AF- 6D AF- 6I AF-19 AF-19P AF-21 AF-21P BL-1D BL-1I BL-5 BL-5D BUR-30D CAM-1D CLI-1D	TAPON DE GASOLINA PETROL CAP		



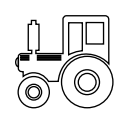
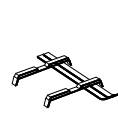
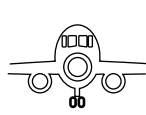

<b>REFERENCIA REFERENCE</b>	<b>TIPO TYPE</b>
WAS-5 WAS-5P WAS-6 WAS-6P WAS-8 WAS-8D	TAPON DE GASOLINA PETROL CAP 

<b>REFERENCIA REFERENCE</b>	<b>TIPO TYPE</b>
AF-7D AF-7I AF-7IP AF-7IP1 AF-8D AF-8DP AF-8I AF-8IP AF-9D AF-9DP AF-9I AF-9IP BH-1 BH-1P BH-2 BH-3 BH-4 BH-5 BH-6 BH-8 CAT-1P CIT-2 DAE-5P DAV-1 DAV-1P FIA-1 FO-35 FO-36 JD-1 JD-2 JD-3D JD-4D MAK-1 MERI-1D MERI-1DP PRE-1I PRE-3 TEU-1 TOYO-27	TRACTOR TRACTOR 







#### JMA HEADQUARTERS ALEJANDRO ALTUNA, S.A.

Tel +34 943 79 30 00  
Fax +34 943 79 72 43  
Bidekuruzeta, 6  
P.O.Box - Apdo. 70  
20500 Arrasate - Mondragón  
Gipuzkoa - SPAIN

www.jma.es  
ventas@jma.es

#### JMA ARGENTINA

JMA ARGENTINA S.A.  
Tel +54 336 4 462 422  
Fax +54 336 4 462 422  
Av. Central Acero Argentino Oeste 678  
Parque industrial COMIRSA  
2900 San Nicolas (Prov. Buenos Aires)

www.jma-argentina.com.ar  
info@jma-argentina.com.ar

#### JMA FRANCE

Tel +33 01 39 22 42 10  
Fax +33 01 39 22 42 11  
Technoparc  
13, rue Edouard Jeanneret  
F-78306 Poissy Cedex

www.jmafrance.fr  
service.commercial@jmafrance.fr

#### JMA INDIA

JMA KEYS INDIA PVT. LTD  
Tel +91 124 428 5450  
Fax +91 124 428 5451  
H-239 & H-240, Sushant Shopping Arcade  
Sushant Lok-1, Block B  
122002 Gurgaon  
Haryana

www.jmakeys.in  
info@jmakeys.in

#### JMA MAROC

JMA MAROC S.A.R.L.  
Tel +0520 150 535  
Fax +0520 150 536  
83,85 Bd Oued ZIZ, El Oulfa

Casablanca  
Marruecos

www.jma.ma  
jma@jma.ma

#### JMA MEXICO

LLAVES ALTUNA DE MEXICO S.A de C.V.  
Tel +52 33 3777 1600  
Fax +52 33 3777 1609  
Av. Aviación No. 5520  
Col. San Juan de Ocotán  
C.P. 45019 Zapopan, Jalisco

www.jma.com.mx  
ventas@jma.com.mx

#### JMA PERÚ

JMA Perú S.A.C.  
Tel +51 639 9300  
Av. Los Paracas 130, Urbanización Salamanca,  
Distrito Ate, Lima

www.jma-peru.com  
info@jma-peru.com

#### JMA POLSKA

JMA POLSKA Sp. z o.o.  
Tel +48 42 635 12 80  
Fax +48 42 635 12 85  
91-342 Łódź, ul. Zbąszyńska 3

www.jmapolska.pl  
biuro@jmapolska.pl

#### JMA PORTUGAL

ALTUNA PORTUGAL  
COMERCIO DE CHAVES UNIPessoal, LDA.  
Tel +351 219 947 470  
Fax +351 219 947 471  
Urbanização dos Azeiros, Lote 67 C/v  
2695-733 São João da Talha

www.jmaportugal.com  
comercial@jmaportugal.com

#### JMA UK

SKS LTD  
Tel +44 144 229 1400  
Fax +44 144 286 3663  
Unit 2, Canal Side  
Northbridge Road  
Berkhamsted  
Herts HP4 1EG

www.jmakeys.co.uk  
sales@skskkeys.co.uk

#### JMA URUGUAY

JMA URUGUAY S.A.  
Tel +598 2908 1175  
Fax +598 2900 6681  
Mercedes 1420  
11100 Montevideo  
Uruguay

www.jma.com.uy  
info@jma.com.uy

#### JMA USA

ALTUNA GROUP USA INC.  
Tel +1 817 385 0515  
Fax +1 817 385 4850  
1513 Greenview Drive  
75050 Grand Prairie, Texas

www.jmausa.com  
info@jmausa.com